

# **BROOKFIELD DV3T**

## **Viscometer**

### Operating Instructions

Manual No. **M13-2100-A0415**



---

*with offices in:* Boston • Chicago • London • Stuttgart • Guangzhou

---

**BROOKFIELD ENGINEERING LABORATORIES, INC.**  
11 Commerce Boulevard, Middleboro, MA 02346 USA  
TEL 508-946-6200 or **800-628-8139** (USA excluding MA)  
FAX 508-946-6262 INTERNET <http://www.brookfieldengineering.com>



# Table of Contents

<b>I. INTRODUCTION .....</b>	<b>5</b>
I.1 Components .....	6
I.2 Utilities .....	8
I.3 Specifications.....	8
I.4 Installation.....	9
I.5 Safety Symbols and Precautions.....	11
I.6 Key Functions .....	11
I.7 Cleaning.....	12
<b>II. GETTING STARTED.....</b>	<b>13</b>
II.1 Power Up.....	13
II.2 AutoZero .....	13
II.3 Status Bar.....	14
II.4 Navigation.....	15
II.5 Home Screen .....	16
II.5.1 Configure Viscosity Test .....	16
II.5.2 Configure Yield Test .....	18
II.5.3 Load Test .....	21
II.5.4 View Results .....	21
II.5.5 Manage Files .....	21
II.5.6 External Mode .....	22
II.6 Range .....	22
II.7 Out of Range .....	23
II.8 Printing .....	24
<b>III. MAKING VISCOSITY MEASUREMENTS .....</b>	<b>26</b>
III.1 Quick Start.....	26
III.2 Preparations for Making Measurements.....	26
III.3 Programming .....	27
III.4 Selecting a Spindle/Speed.....	28
III.5 Temperature Control.....	30
III.6 Multiple Data Points.....	31
III.7 Selecting Data Collection.....	32
III.8 End Condition .....	34
III.9 Additional Test Parameters .....	35
III.10 Running a Test.....	38
III.11 Results.....	40
III.12 Data Averaging .....	44
<b>IV. MAKING YIELD MEASUREMENTS.....</b>	<b>47</b>
IV.1 Quick Start.....	47
IV.2 Preparations for Making Measurements.....	47
IV.3 Selecting a Spindle/Speed .....	48
IV.4 Temperature Control.....	49

IV.5 Test Parameters.....	50
IV.6 Running a Yield Test.....	53
IV.7 Results.....	54
<b>V. SETTINGS.....</b>	<b>57</b>
V.1 Device Setup .....	57
V.2 User Settings .....	62
V.3 Global Settings .....	64
V.4 Admin Functions .....	69
V.4.1 Log In and Lock Out.....	69
V.4.2 Users and Access.....	70
V.4.3 Set Time and Date.....	72
V.4.4 Backup and Import .....	72
V.4.5 Default Path.....	73
V.4.6 Settings Reset.....	74
V.4.7 Device Reset .....	74
V.4.8 Calibration Reminder.....	74
V.4.9 Save Audit Trail.....	75
<b>VI. PG FLASH SOFTWARE.....</b>	<b>76</b>
<b>VII. MATH MODELS.....</b>	<b>80</b>
VII.1 The Power Law (Ostwald) Model .....	80
VII.2 The Herschel-Bulkley Model .....	82
VII.3 The Bingham Model .....	84
VII.4 The Casson Model .....	86
VII.5 Other Rheological Models.....	88
<b>Appendix A - Cone/Plate Rheometer Set-Up.....</b>	<b>90</b>
<b>Appendix B - Viscosity Ranges .....</b>	<b>94</b>
<b>Appendix C - Variables in Viscosity Measurements .....</b>	<b>98</b>
<b>Appendix D - Spindle Entry Codes and SMC/SRC Values .....</b>	<b>100</b>
<b>Appendix E - Spindle Entry Codes and Range Coefficients.....</b>	<b>103</b>
<b>Appendix F - Calibration Procedures .....</b>	<b>105</b>
<b>Appendix G - The Brookfield Guardleg .....</b>	<b>112</b>
<b>Appendix H - Speed Selection .....</b>	<b>114</b>
<b>Appendix I - Laboratory Stands.....</b>	<b>115</b>
<b>Appendix J - DVE-50A Probe Clip.....</b>	<b>118</b>
<b>Appendix K - Screen Protector.....</b>	<b>119</b>
<b>Appendix L - Fault Diagnosis and Troubleshooting.....</b>	<b>121</b>
<b>Appendix M - Instrument Dimensions .....</b>	<b>123</b>
<b>Appendix N - Online Help and Additional Resources .....</b>	<b>124</b>
<b>Appendix O - Warranty Repair and Service .....</b>	<b>125</b>
<b>Viscosity Test Report .....</b> (Tear Out Page)	<b>127</b>

## I. INTRODUCTION

The Brookfield DV-III Rheometer series has been the leading industrial rheometer since it was first introduced in 1989. Brookfield has continued to develop and improve the DV-III to provide the best value in the market for both quality control and research customers. The Brookfield DV3T Rheometer continues in this tradition of innovation, quality and value. The incorporation of a full color graphical touch screen display has allowed for a new and improved user interface which preserves the single speed data collection methods while making all of the advanced features of the DV3T readily available.

The Brookfield DV3T Rheometer measures fluid viscosity at given shear rates. Viscosity is a measure of a fluid's resistance to flow. You will find a detailed description of the science of viscosity in the Brookfield publication "*More Solutions to Sticky Problems*", a copy of which was included with your DV3T.

This manual covers the DV3T Rheometer and the DV3T Extra Rheometer. The DV3T Extra is a special package that includes several optional features to maximize the utility of the DV3T. The DV3T Extra includes: Ball Bearing Suspension (not included in LV versions), EZ-Lock spindle connection, Model Q Lab Stand, and RheocalcT Software. These differences are detailed in the Components section of the manual. All references to the rheometer in this manual will be made as DV3T. All of the optional features of the DV3T Extra may be added individually to the DV3T Rheometer.

The DV3T offers exceptional versatility in modes of control, allowing choice of traditional standalone operation and automatic operation through programs downloaded from the PC or with complete control by PC using Brookfield RheocalcT Software.

- The DV3T can be used as a traditional Brookfield rheometer for collection of single speed viscosity data through the easy to use touch screen; just select the spindle and speed and read the value from the display. **[See Section II: Getting Started]**
- The DV3T can collect multiple data points through programs created directly on the touchscreen display.
- The DV3T can make a direct measurement of yield stress when using optional vane spindles.
- The Brookfield PG Flash Software can be used to program the DV3T to control all aspects of the test and data collection without the need for the operator to monitor the instrument; just start the program and return to the printed test data (printer is optional). **[See Section V: PG Flash Software]**
- The Brookfield RheocalcT Software will perform all control and data collection functions of the DV3T from the PC while also providing a platform for advanced data collection and analysis.

In any of these modes of control, the DV3T will provide the best in viscosity measurement and control.

The principal of operation of the DV3T is to drive a spindle (which is immersed in the test fluid) through a calibrated spring. The viscous drag of the fluid against the spindle is measured by the spring deflection. Spring deflection is measured with a rotary transducer. The measurement range of a DV3T (in centipoise or milliPascal•seconds) is determined by the rotational speed of the spindle, the size and shape of the spindle, the container the spindle is rotating in, and the full scale torque of the calibrated spring.

There are four basic spring torque series offered by Brookfield:

<u>Model</u>	<b>Spring Torque</b>	
	<u>dyne•cm</u>	<u>milliNewton•m</u>
DV3TLV	673.7	0.0673
DV3TRV	7,187.0	0.7187
DV3THA	14,374.0	1.4374
DV3THB	57,496.0	5.7496

The higher the torque calibration, the higher the measurement range. The measurement range for each torque calibration may be found in Appendix B.

**All units of measurement are displayed according to either the CGS system or the SI system.**

1. Viscosity appears in units of centipoise (cP), Poise (P), milliPascal-seconds (mPa•s) or Pascal-seconds (Pa•s) on the DV3T Rheometer display or centistokes (cSt) or millimeter squared per second (mm<sup>2</sup>/sec).
2. Shear Stress appears in units of dynes/square centimeter (D/cm<sup>2</sup>) or Newtons/square meter (N/m<sup>2</sup>)/or Pascals (Pa).
3. Shear Rate appears in units of reciprocal seconds (1/sec).
4. Torque appears in units of dyne-centimeters or Newton-meters (shown as percent “%” in both cases) on the DV3T Rheometer display.
5. Density appears in units of grams/cubic centimeter (g/cm<sup>3</sup>) or kilograms/cubic meter (kg/m<sup>3</sup>).

**Note:** To change CGS to SI units on the display (see Section IV.3: Global Settings).

The equivalent units of measurement in the SI system are calculated using the following conversions:

	<u>SI</u>	=	<u>CGS</u>
Viscosity:	1 mPa•s	=	1 cP
Shear Stress:	1 Newton/m <sup>2</sup>	=	10 dyne/cm <sup>2</sup>
Torque:	1 Newton•m	=	10 <sup>7</sup> dyne•cm

References to viscosity throughout this manual are done in CGS units. The DV3T Rheometer provides equivalent information in SI units.

## I.1 Components

Please check to be sure that you have received all components, and that there is no damage. If you are missing any parts, please notify Brookfield Engineering or your local Brookfield agent immediately. Any shipping damage must be reported to the carrier.

Components	Part Number	Quantity	
		DV3T	DV3T Extra
DV3T Rheometer	varies	1	1
Model G Laboratory Stand	MODEL G	1	∅
Model Q Laboratory Stand	MODEL Q	∅	1
Spindle Set with Case*	varies	1	1
DV3TLV set of four spindles	SSL or SSLK <sup>†</sup>	or	
DV3TRV set of six spindles (#2 - #7)	SSR or SSRK <sup>†</sup>	or	
DV3THA / HB set of six spindles (#2 - #7)	SSH or SSHK <sup>†</sup>		
<b>For Cone/Plate versions: a spindle wrench (SP-23), one cone spindle (CPA-XXZ), a sample cup (CPA-44YZ) replace the spindle set.</b>			
Power Cord	varies	1	1
RTD Temperature Probe	DVP-94Y	1	1
Guard Leg		1	1
DV3TLV	B-20Y or B-20KY <sup>†</sup>	or	
DV3TRV	B-21Y or B-21KY <sup>†</sup>		
Carrying Case	DVE-7Y	1	1
PG Flash Software	CD ProgA	1	1
RheocalcT Software	GV-3003	∅	1
USB Flash Drive	GV-1044	1	1
Screen Cloth w/case	GV-1045	1	1
Stylus	GV-1043	1	1
Operating Manual	M13-167	1	1
Shipping Cap	N/A	1	1
Screen Protector	GV-1020	1	1

\* Not supplied with Cone/Plate version.

† “K” in the part number identifies EZ-Lock Spindles and Guardlegs

# COMPONENT DIAGRAM

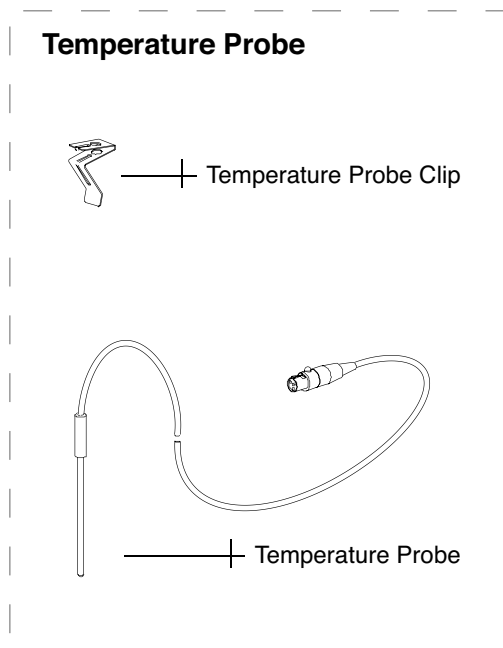
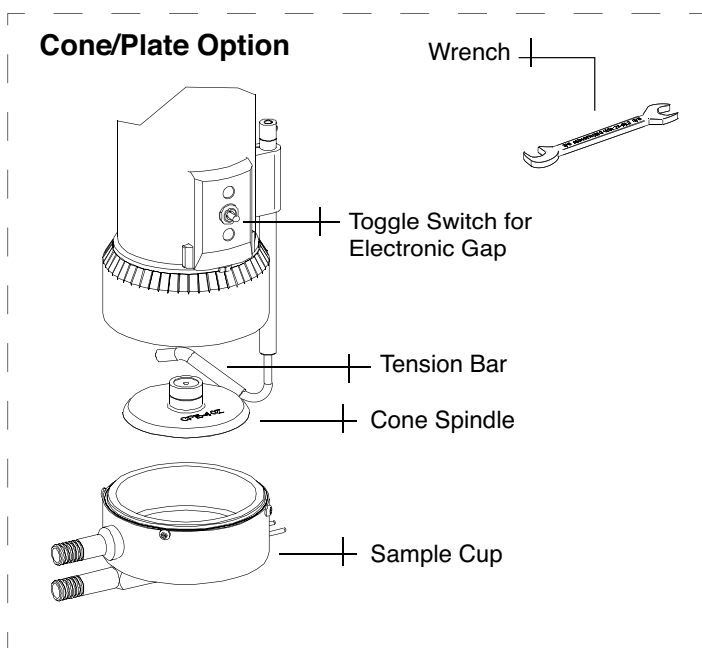
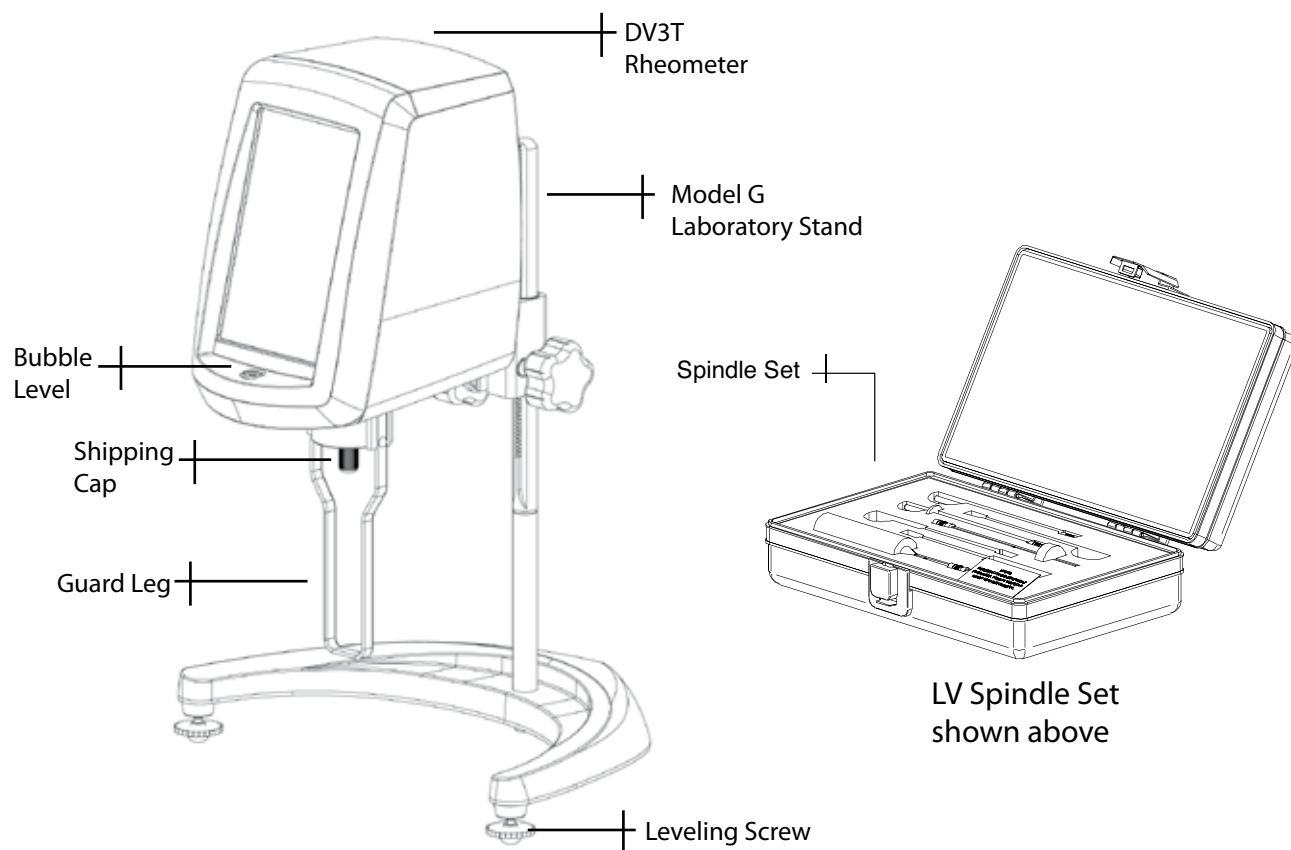

Figure I-1

## I.2 Utilities

Input Voltage: Universal Power Supply (90 - 264 VAC)  
Input Frequency: 50/60 Hz  
Power Consumption: 150 VA  
Power Cord Color Code:

	<b>United States</b>	<b>Outside United States</b>
Hot (live)	Black	Brown
Neutral	White	Blue
Ground (earth)	Green	Green/Yellow



Main supply voltage fluctuations are not to exceed  $\pm 10\%$  of the nominal supply voltage.

## I.3 Specifications

**Speeds:** 0.01 - 250 RPM

**Weight:** Gross Weight 23 lbs. 10.5 kg.  
Net Weight 20 lbs. 9 kg.  
Carton Volume 1.65 cu. ft. 0.05 m<sup>3</sup>  
Carton Dimensions 22 in. (56 cm) W x 11 in. (28 cm) L x 22 in. (56 cm) H

**Temperature Sensing Range:** -100°C to 300°C (-148°F to 572°F)

**USB A Port for use with an attached PC.**

**USB B Port (x3) for use with a USB Flash Drive and Dymo Printer.**

**Viscosity Accuracy:**  $\pm 1.0\%$  of full scale range  
The use of accessory items will have an effect on the measurement accuracy. See Appendix B.

**Viscosity Repeatability:**  $\pm 0.2\%$  of Full Scale Range

**Temperature Accuracy:**  $\pm 1^\circ\text{C}$  | -100°C to +149°C  
 $\pm 2^\circ\text{C}$  | +150°C to +300°C

**Operating Environment:** 0°C to 40°C temperature range (32°F to 104°F)  
20% - 80%R.H.: non-condensing atmosphere

### **Ball Bearing Option:**

If you ordered the ball bearing suspension system with your new instrument, please note the following:

- 1) The ball bearing suspension in your Brookfield instrument is noted on the serial tag on the back of the head by the letter "B" in the part number (the ninth digit; for example: XDV3THBTB00U00).
- 2) When attaching and detaching the spindle, it is not necessary to lift the coupling where the spindle connects to the instrument.
- 3) The Oscillation Check, explained in Section IV.1: Device Setup, does not pertain to this instrument.



### Electrical Certifications:

Conforms to CE Standards:

- BSEN 61326: Electrical equipment for measurement, control and laboratory use - EMC requirements.
- BSEN 61010-1: Safety requirements for electrical equipment, for measurement, control and laboratory use.  
Airborne Noise Emissions - levels do not exceed 70 dB(A).

### Notice to customers:



This symbol indicates that this product is to be recycled at an appropriate collection center.

### Users within the European Union:

Please contact your dealer or the local authorities in charge of waste management on how to dispose of this product properly. All Brookfield offices and our network of representatives and dealers can be found on our website: [www.brookfieldengineering.com](http://www.brookfieldengineering.com).

### Users outside of the European Union:

Please dispose of this product according to your local laws.

## I.4 Installation

*Note:* “IQ, OQ, PQ”, an abbreviated guideline document for installation, operation and performance validation for your DV3T digital rheometer, can be downloaded from our website [www.brookfieldengineering.com](http://www.brookfieldengineering.com). A more detailed IQ, OQ, PQ procedure is available for purchase from Brookfield or your authorized dealer.

1. Assemble the Model G Laboratory Stand (refer to assembly instructions in Appendix I).
2. Put the rheometer on the stand.
3. Connect the RTD probe to the socket on the rear panel of the DV3T.
4. The rheometer must be leveled. The level is adjusted using the two leveling screws on the base. Adjust so that the bubble level on the front of the DV3T is centered within the circle.

*Note:* Check level periodically during use.

5. Remove the shipping cap which secures the coupling nut on the rheometer to the pivot cup. For Cone/Plate Models, hold the Sample Cup and swing the tension bar away from the bottom of the cup. Lower the cup and remove the foam insert. (Save for future shipments.)
6. **Optional:** Install the screen protector per the instructions on the package (and also shown in Appendix K). Failure to properly install the screen protector may result in touch screen malfunction. Additional installation help can also be found on our YouTube channel: [www.youtube.com/user/BrookfieldEng](http://www.youtube.com/user/BrookfieldEng)



The AC input voltage and frequency must be within the appropriate range as shown on the nameplate of the viscometer (see Section I.2)

7. Make sure that the AC power switch at the rear of the DV3T is in the OFF position. Connect the power cord to the socket on the back panel of the instrument and plug it into the appropriate AC line. For Cone/Plate Models, be sure that the toggle switch, used to activate the electronic gap, is to the left position. (Left when facing the rheometer.)



The AC input voltage and frequency must be within the appropriate range as shown on the nameplate of the rheometer. (See Section I.2.)



**Note:** The DV3T must be earth grounded to ensure against electronic failure!!

8. Turn the power switch to the ON position and allow the rheometer to warm up for 10 minutes before performing autozero.
9. For Cone/Plate models, refer to Appendix A.
10. If appropriate, connect USB cable (DVP-202) to USB port for connection of DV3T to PC or printer.
11. Review Read Me file. The Read Me file contains notes on the DV2T Firmware. This file can be found on the CD that contains the PG Flash Software.

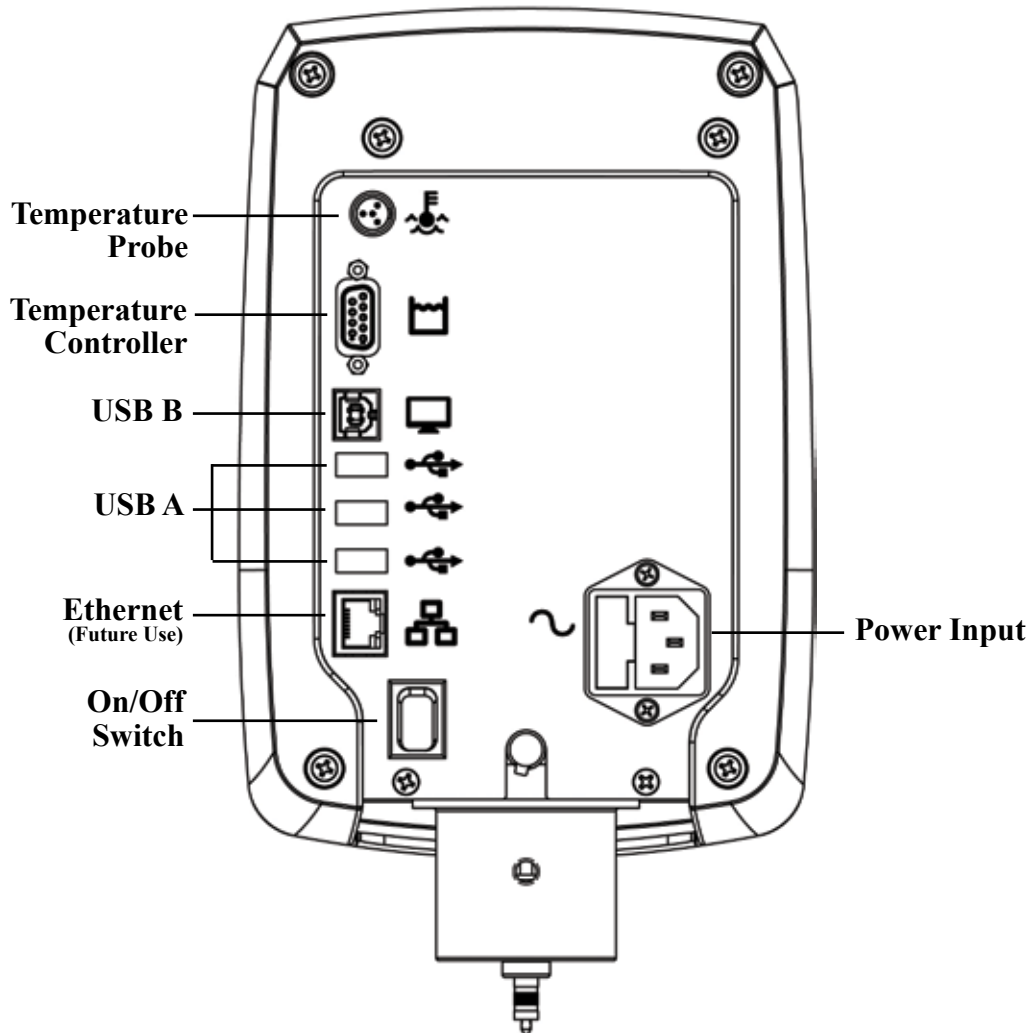



Figure I-2





## I.5 Safety Symbols and Precautions

### Safety Symbols

The following explains safety symbols which may be found in this operating manual.

-  Indicates hazardous voltages may be present.
-  Refer to the manual for specific warning or caution information to avoid personal injury or damage to the instrument.

### Precautions

-  If this instrument is used in a manner not specified by the manufacturer, the protection provided by the instrument may be impaired.
-  This instrument is not intended for use in a potentially hazardous environment.
-  In case of emergency, turn off the instrument and then disconnect the electrical cord from the wall outlet.
-  The user should ensure that the substances placed under test do not release poisonous, toxic or flammable gases at the temperatures which they are subjected to during the testing.

## I.6 Key Functions

The DV3T Rheometer utilizes a touch screen display and interface. The user will provide all input to the rheometer through the touch screen. Figure I-3 details the different types of information and actions available.

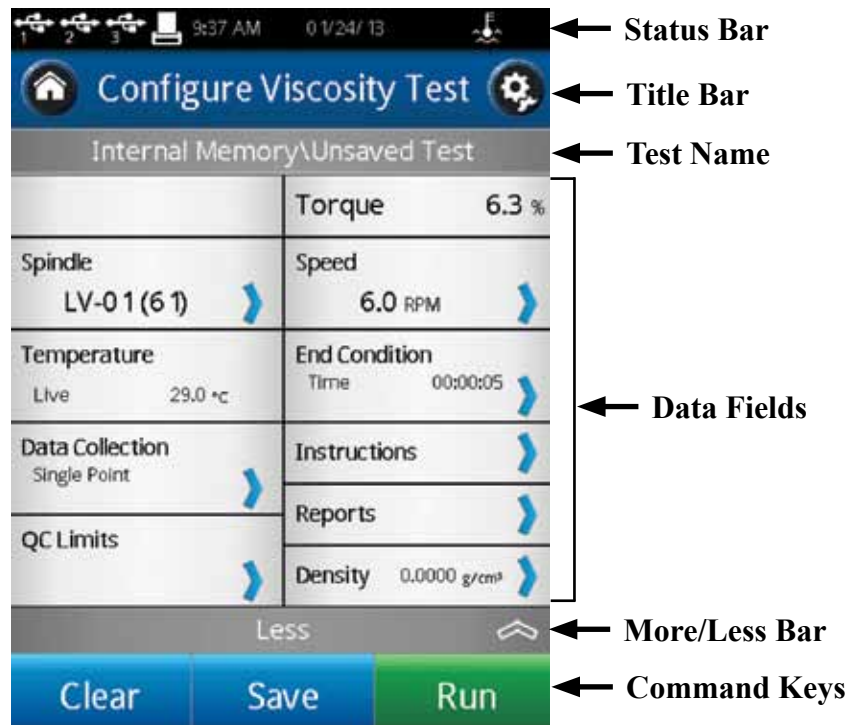





Figure I-3

- Status Bar:** The Status Bar provides information relating to the date and time (as configured by the user) and various connections to the DV3T Rheometer.
- Title Bar:** The Title Bar identifies the activity to be conducted in the current view and includes any navigation icons that are relevant.
- Test Name:** The Test Name identifies the name of the currently loaded test.
- Data Fields:** The Data Fields include measurement results and test parameters.
- More/Less Bar:** The More/Less Bar informs the user when more Data Fields are available and when the number of Data Fields can be reduced.
- Command Keys:** The Command Keys indicate action that can be taken. These keys will vary from view to view depending on what actions are relevant.

## I.7 Cleaning

-  Make sure that the instrument is in a clean, dry working environment (dust-free, moderate temperature, low humidity, etc.).
-  Make sure the instrument is on a level surface.
-  Hands/fingers must be clean and free of sample residue. Not doing so may result in deposit build up on the upper part of the shaft and cause interference between the shaft and the pivot cup.
-  Be sure to remove the spindle from the instrument prior to cleaning. Note left-handed thread. Severe instrument damage may result if the spindle is cleaned in place.

Instrument and Display: Clean with a dry, non-abrasive cloth. Do not use solvents or cleaners. The instrument housing is manufactured from polycarbonate ABS. Clean instrument housing with mild soap and water. **Do not apply solvent to the instrument!**

Immersed Components (spindles): Spindles are made of stainless steel. Clean with a non-abrasive cloth and solvent appropriate for sample material.

-  When cleaning, do not apply excessive force, which may result in bending spindles.

## II. GETTING STARTED

### II.1 Power Up

The DV3T will go through a Power Up sequence when the power is turned on. The Rheometer will issue a beep, present a blue screen, and finally show the DV3T About screen for 5 seconds. The About screen is shown below and includes several critical parameters about the rheometer including; rheometer torque (LV, RV, HA, HB, or other), firmware version number, model number (DV3TLV for example) and the serial number.

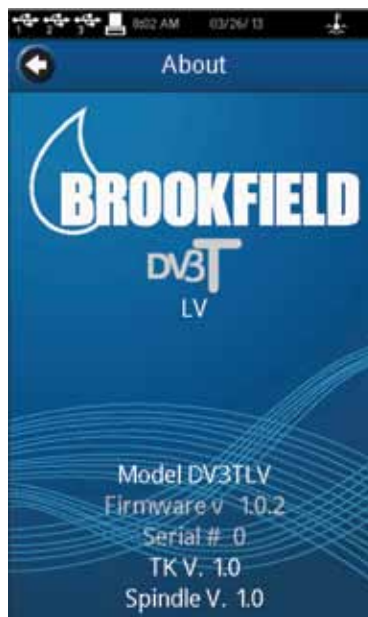

**Figure II-1**

The About screen can also be accessed through the Settings Menu  (see Section V.1).

The DV3T Rheometer will automatically transition from the About screen to the AutoZero screen.

**TIP:** When contacting Brookfield or your authorized Brookfield dealer for technical support or repair services, please record the information on the About screen and include this detail in your email.

### II.2 AutoZero

The DV3T Rheometer must perform an AutoZero prior to making viscosity measurements. This process sets the zero reading for the measurement system. The AutoZero will be performed every time the instrument is turned on. Additionally, you may perform an AutoZero at any time through the Settings Menu  (see Section V.1).

The AutoZero screen will be presented automatically, after the About screen, during a power up.

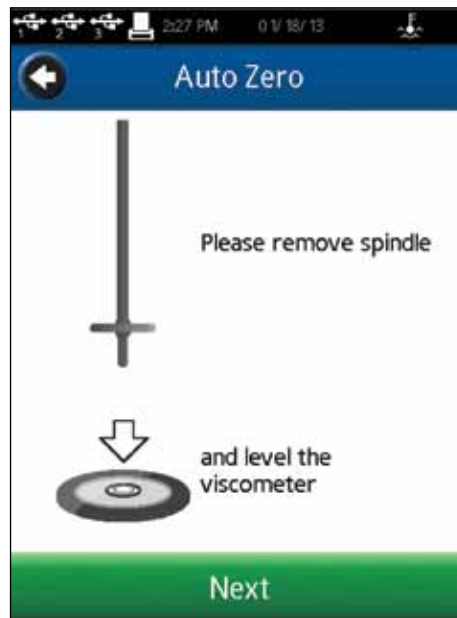

**Figure II-2**

The operator must ensure that the rheometer is level (see Section I.4) and remove any attached spindle or coupling. When the Next button is pressed, the rheometer will operate for approximately 13 seconds. After the AutoZero is complete and the operator presses the Next button, the rheometer will transition to the Configure Viscosity Test screen. If the AutoZero was performed from the Settings Menu, then the rheometer will return to the Settings Menu.

TIP: Do not touch the rheometer during the AutoZero process to ensure the best zero value.

### II.3 Status Bar

The DV3T Rheometer will display a status bar at the top of the screen at all times.

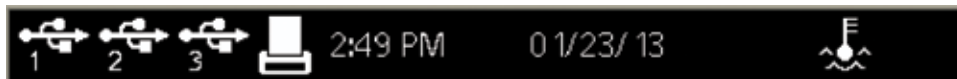

This status bar will indicate: time of day, date, and connection status for a variety of connection devices. The status icons are defined as:



USB Icon 1,2,3: The DV3T Rheometer can store data and tests to USB storage device (USB B) such as a USB Flash Drive. There are three USB ports. These ports are represented as 1, 2 and 3 based on the order of connection.



Printer Icon: The DV3T Rheometer can communicate to a label printer for printing test results (see Section II.8).



Computer Icon: The DV3T Rheometer can communicate with a computer through the USB A port. Communication is supported with Brookfield RheocalcT software.



Bath Icon: The DV3T Rheometer can communicate with a Brookfield Thermosel (HT-106 Controller) or Temperature Bath (SD or AP Controllers) to control sample temperature.

## II.4 Navigation

The DV3T Rheometer uses a touch screen display. Navigation of the instrument features is done using a variety of Data Fields, Arrows, Command Keys and Navigation Icons. The operating system has been designed for intuitive operation and employs color to assist the user in identifying options.

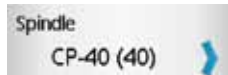

Data Fields require that the user touch the screen to initiate the data entry / selection process. These fields are normally outlined in black. They may also include a blue arrow.



Blue Arrows indicate that options exist for a Data Field. The user may be required to press anywhere in the Data Field or they may have to press the Blue Arrow specifically.



Command Keys are buttons which direct the DV3T to perform a specific action such as SAVE a data set or STOP a program. Command Keys are presented in a variety of colors. These keys are normally found at the bottom of the screen.



Navigation Icons are normally found in the Title Bar to the left and right. These buttons will take you to specific areas of the operating system.

Navigation Icons are shown below.



Home Menu



Log In (will only be available if the administrator has activated user log in)



Settings Menu



Service Menu (only available for authorized Brookfield service centers)



Lock Out (during a test)



Remove Lock (during a test)



Perform data entry using a number pad



Perform data entry from a scroll list



Sort files according to create date



Sort files according to alphabet



Choose from additional options



Back (return to previous screen)



Up (return to previous level in the file structure)

## II.5 Home Screen

The DV3T Home screen can be accessed by using the Home Icon . The Home screen shows the Main Menu functions and provides access to User Log In and Settings (see Section V.4).

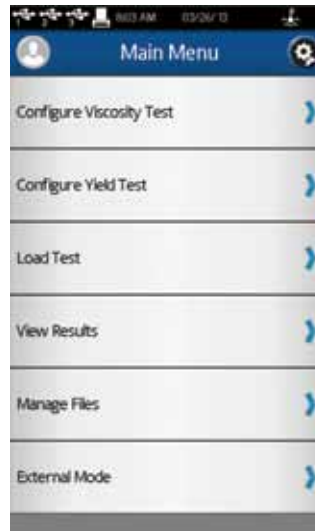

Figure II-3

**Configure Viscosity Test:** Create and Run viscosity tests.

**Configure Yield Test:** Create and Run yield tests.

**Load Test:** Load a test that has previously been saved or created with PG Flash software. Tests may be loaded from internal memory or a USB Flash Drive.

**View Results:** Load Results (saved test data) that have previously been saved. Results may be loaded from internal memory or a USB Flash Drive.

**Manage Files:** Manage the file system in the internal memory or on a USB Flash Drive for test programs and saved data. Create new folder structures, delete files, rename files and move files.

**External Mode:** Direct the DV3T to communicate with Brookfield RheocalcT Software for complete rheometer control.

Each of the Main Menu items are detailed in the following sections of the manual.

### II.5.1 Configure Viscosity Test

Viscosity measurements are made on the DV3T Rheometer through the Configure Viscosity Test function. The user is presented with Configure Viscosity Test at the conclusion of the AutoZero function or by selection on the Home Menu .

All elements related to the measurement of viscosity are selected within Configure Viscosity Test. Tests that are created can be saved to the internal memory of the DV3T Rheometer or onto a connected USB Flash Drive. Tests can be loaded from memory by selecting Load Test from the Home Screen .

TIP: Many aspects of Configure Viscosity Test can be limited when User ID and Log In functions are implemented (see Section V.4.2).



The basic Configure Viscosity Test view is shown in Figure II-4. This view includes the Status Bar (Section II.3), Title Bar (which includes the Home and Settings icons), test name, test parameters, the More/Less bar, and Command Keys (see Section II.4).

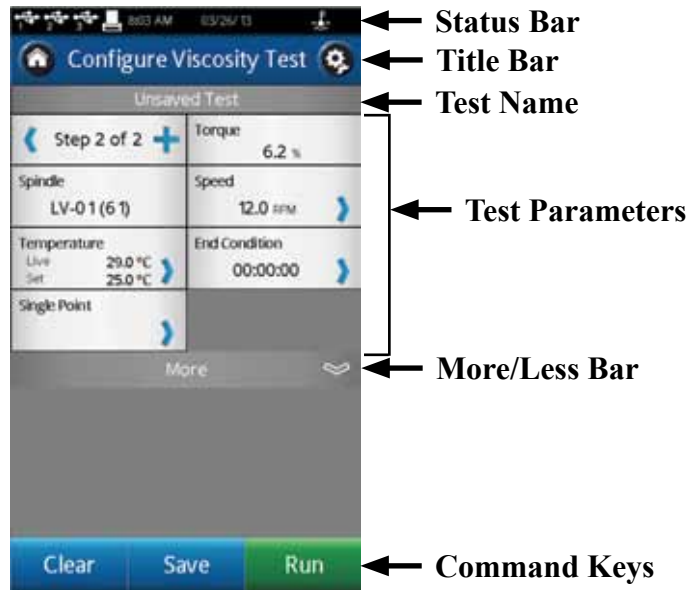

**Figure II-4**

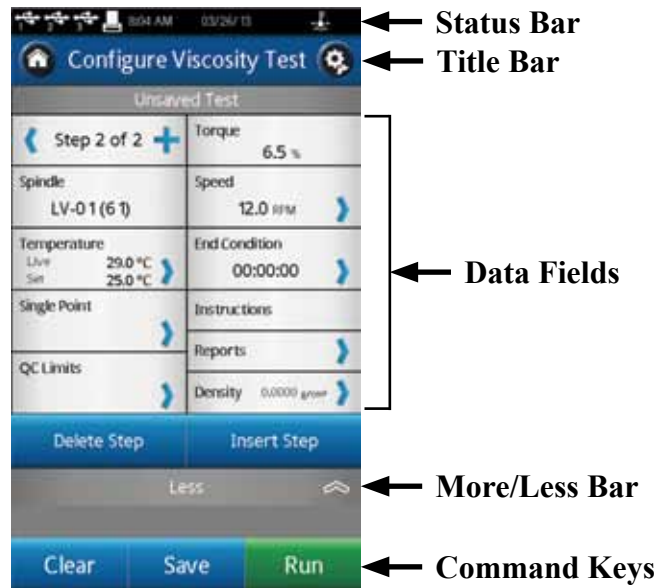

The user can see the name of any test that has been loaded through the Load Test function. In Figure II-4, the file name is listed as Unsaved Test, indicating that the current test has not been saved.

The More/Less bar is seen just below the test parameters. In Figure II-4, this bar includes a down arrow, which indicates that more information is available. Figure II-5 shows the additional information that can be accessed. The More/Less bar, in this view, now has an up arrow indicating that the additional information can be hidden.







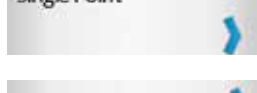





**Figure II-5**

The Command Keys include Clear, Save and Run.

	Clear:	Clear all data that has been entered into the test parameters and restore the values to the factory default.
	Save:	Save the current test.
	Run:	Run the current test.

The Test Parameter area includes many elements of the viscosity test as well as live measurements of Torque % and Temperature. Temperature data will only be displayed if a Brookfield temperature probe is connected to the DV3T Rheometer.

	Torque:	A live signal from the rheometer.
	Spindle:	The currently selected spindle. All viscosity, shear rate, and shear stress calculations will be made based on this spindle. The spindle number may be changed by pressing the blue arrow.
	Speed:	The currently selected speed of rotation. The rheometer will operate at this speed once the RUN command key is pressed. The speed may be changed by pressing the blue arrow.
	Temperature:	A live signal from the rheometer when a temperature probe is attached (Brookfield part number DVP-94Y or SC4-61Y).
	End Condition:	Specify the condition that will end the test.
	Data Collection:	Specify the amount of data to be collected during the test.
	Instructions:	Create a message that the user will see when the test begins.
	Reports:	Define how the data will be viewed when the test is complete.
	QC Limits:	Define the limits for acceptable measurement data.
	Density:	Define the density of the test sample. This information will be used when kinematic viscosity units are selected for display (see Section V.4.2)

## II.5.2 Configure Yield Test

Yield measurements are made on the DV3T Rheometer through the Configure Yield Test function. The user can select Configure Yield Test from the Home Menu .

All elements related to the measurement of yield are selected within Configure Yield Test . Tests that are created can be saved to the internal memory of the DV3T Rheometer or onto a connected USB Flash Drive. Tests can be loaded from memory by selecting Load Test from the Home Screen .

TIP: Many aspects of configure Yield Test can be limited when User ID and Log In functions are implemented (see Section V.4.2).

The basic Configure Yield Test view is shown in Figure II-6. This view includes the Status Bar (Section II.3), Title Bar (which includes the Home and Settings icons), test name, test parameters, the More/Less bar, and Command Keys (see Section II.4).

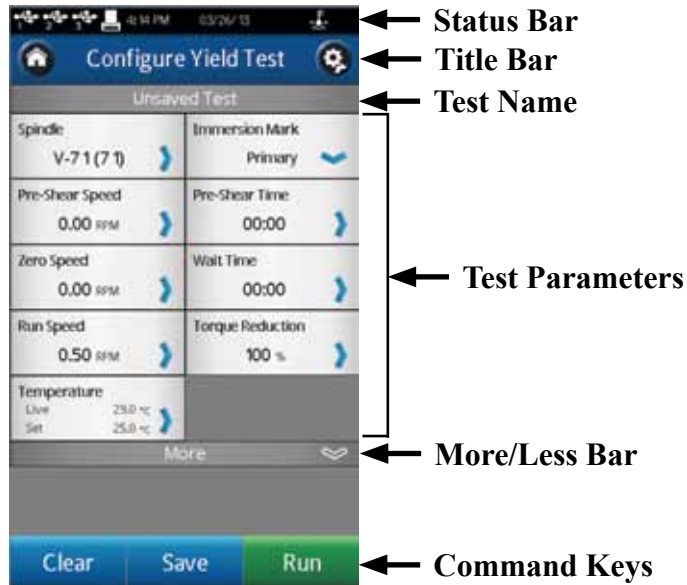

Figure II-6

The user can see the name of any test that has been loaded through the Load Test function. In Figure II-6, the file name is listed as Unsaved Test, indicating that the current test has not been saved. The More/Less bar is seen just below the test parameters. In Figure II-6, the bar includes a down arrow, which indicates that more information is available. Figure II-7 shows the additional information that can be accessed. The More/Less bar in this view now has an up arrow indicating that the additional information can be hidden.

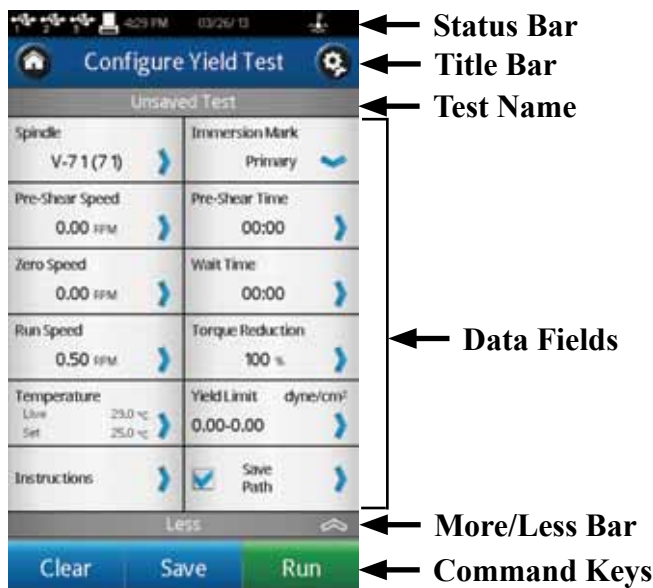



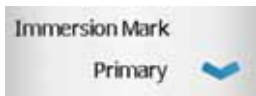
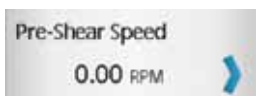
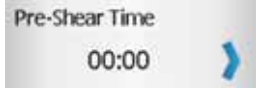









Figure II-7

The command Keys include Clear, Save and Run.

	Clear: Clear all data that has been entered into the test parameters and restore the values to the factory default.
	Save: Save the current test.
	Run: Run the current test.



The test parameter area includes many elements of the yield test as well as live measurement of temperature. Temperature data will only be displayed if a Brookfield temperature probe is connected to the DV3T Rheometer.

	Spindle: The currently selected spindle. All Yield and Stress calculations will be made based on the Spindle selection and the Immersion Mark. Spindle choice is limited to vane spindles or user defined custom spindles.
	Immersion Mark: Specify the immersion location of the Brookfield vane spindle. Primary is at the immersion mark shown on the spindle shaft. Secondary is at the mid-point of the vane surface (see Section IV.5).
	Pre-Shear Speed: Specify a speed of rotation for pre-shear of the sample
	Pre-Shear Time: Specify the duration of the Pre-Shear step.
	Zero Speed: Specify the speed of rotation used to return the %Torque reading to zero before starting the yield measurement.
	Wait Time: Specify the duration of a rest period prior to starting the yield test.
	Run Speed: Specify the speed of the yield test.
	Torque Reduction: Specify the end point of the test. Normally set to 100%.
	Temperature: A live signal from the rheometer when a temperature probe is attached (Brookfield Part No. DVP-94Y). Also shown is the set point used to control the attached temperature controller (Brookfield Thermosel or TC-XX0SD / TC-XX0AP Temperature Baths).
	Yield Limit: Define the limits for acceptable measurement data.
	Instructions: Create a message that the user will see when the test begins.
	Save Path: Define the memory location where the data will be saved.

### II.5.3 Load Test

Test programs that are created (Configure Viscosity Test/Configure Yield Test) can be saved to the internal memory of the DV3T or to a USB Flash Drive. These files can be reloaded into the DV3T for immediate use through the Load Test function. A file that is placed onto a USB Flash Drive can be loaded onto any DV3T Rheometer.

Within the Load Test function, the user can access the internal memory of the rheometer or any USB Flash Drive that is connected to a USB port . The rheometer will point to the USB Flash Drive according to the order in which it is connected. The first USB Flash Drive that is connected will be referred to as #1 on both the Load Test screens and the Status Bar (see Section II.3). You can have as many as three USB Flash Drives connected to the DV3T at any time.



Test files that are displayed on the screen can be sorted by date of creation or by alpha/numeric. This sorting is selected by pressing the Navigation Icon  or .

TIP: You can use the Manage Files function  to move Test files from internal memory to a USB Flash Drive.

### II.5.4 View Results

Test results (data files) can be saved to the internal memory of the DV3T or to a USB Flash Drive. These files can be reloaded into the DV3T for review, analysis, or printing through the View Results function. A file of Test Results that is saved onto a USB Flash Drive can be viewed on any DV3T Rheometer.

Within the View Results function, the user can access the internal memory of the DV3T Rheometer or any USB Flash Drive that is connected to a USB port . The rheometer will point to the USB Flash Drive according to the order in which it is connected. The first USB Flash Drive that is connected will be referred to as #1 on both the View Results screen and the Status Bar. You can have as many as three USB Flash Drives connected to the DV3T at any time.

Results files that are displayed on the screen can be sorted by date of creation or by alpha/numeric. This sorting is selected by pressing the Navigation Icon  or .

TIP: You can use the Manage Files function  to move Results files from internal memory to a USB Flash Drive.

### II.5.5 Manage Files

Result Files and Test Files can be managed in the internal memory or on USB Flash Drives from the Manage Files function. Folder structures can be added or changed to assist with data management. Files may be copied, moved, renamed or deleted. Access to this function can be limited when User ID and Log In functions are implemented (see Section V.4.2).

Files that are displayed on the screen can be sorted by date of creation or by alpha/numeric. This sorting is selected by pressing the Navigation Icon  or .

## II.5.6 External Mode

The DV3T Rheometer can be controlled from a computer through the use of optional Brookfield Software RheocalcT. The rheometer must be placed into external control mode from the Main Menu . The rheometer must be connected to the computer with a USB A cable (DVP-202).

TIP: The Status Bar will indicate a proper connection to the computer by displaying the Computer Icon .

The DV3T will display External Mode when configured for operation with the computer. This display includes a Return button that will reset the rheometer to stand alone operation.

## II.6 Range

The DV3T Rheometer will calculate the measurement range for a specific spindle and speed combination. This information is displayed on the screen while selecting the spindle number as shown in Figure II-6. The Range is also shown in the Running Viscosity Test view during the measurement. Viscosity will be displayed in the unit of measure specified in Settings  and is set to centipoise (cP) from the factory.



Figure II-6

TIP: The Range value is the same as the AutoRange available on earlier Brookfield rheometer models.

## II.7 Out of Range

The DV3T Rheometer will give on screen indications when the measurement is out of range of the instrument. When the %Torque reading exceeds 100% (over range), the display of %Torque, Viscosity, and Shear Stress will be EEEE (see Figure II-7). If the %Torque value is between 0 - 9.9%, the data field label will flash. When the %Torque is below zero (negative values), the display of Viscosity and Shear Stress will be ----.

TIP: Brookfield recommends collecting data only when the %Torque reading is between 10 - 100%.

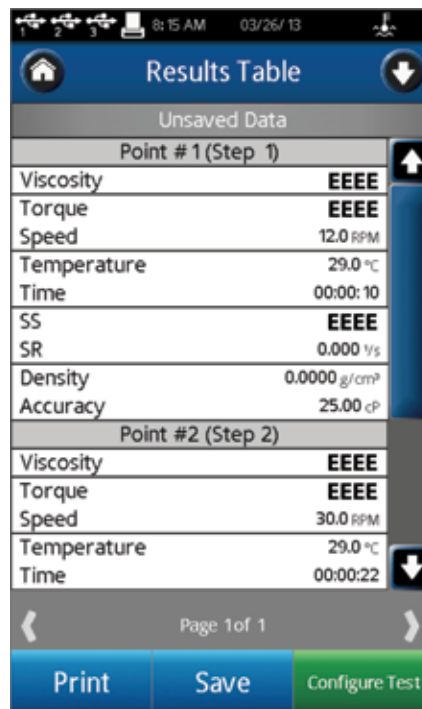

The screenshot shows a mobile application interface titled "Results Table" with a status bar at the top displaying "8:15 AM 03/26/13". Below the title is a section for "Unsaved Data" containing two test points. Point #1 (Step 1) shows Viscosity, Torque, and SS as "EEEE", Speed as 12.0 RPM, Temperature as 29.0 °C, Time as 00:00:10, SR as 0.000 1/s, Density as 0.0000 g/cm³, and Accuracy as 25.00 cP. Point #2 (Step 2) shows Viscosity, Torque, and SS as "EEEE", Speed as 30.0 RPM, Temperature as 29.0 °C, and Time as 00:00:22. At the bottom, there are three buttons: "Print", "Save", and "Configure Test".

Unsaved Data	
Point #1 (Step 1)	
Viscosity	EEEE
Torque	EEEE
Speed	12.0 RPM
Temperature	29.0 °C
Time	00:00:10
SS	EEEE
SR	0.000 1/s
Density	0.0000 g/cm³
Accuracy	25.00 cP
Point #2 (Step 2)	
Viscosity	EEEE
Torque	EEEE
Speed	30.0 RPM
Temperature	29.0 °C
Time	00:00:22

Figure II-7

Measurement data should not be collected when the %Torque reading is out of range. The out of range condition can be resolved by either changing the speed (reduce speed when reading is out of range: high) or changing the spindle (increase the spindle size when the reading is out of range: low).

TIP: When comparing data, the test method is critical. Be sure that you know the proper spindle and speed required for the test method. If readings are out of range, this condition should be reported as the test result.

## II.8 Printing

The DV3T Rheometer can communicate to a Dymo Label Writer 450 Turbo label printer. This printer can be purchased from Brookfield (Part No. GV-1046). The communication to the printer is by USB (cable provided with the printer). When the printer is connected to the DV3T, the printer icon will be visible in the status bar.

There is no provision at this time to have other drivers for other printers work with the DV3T.

The DV3T Rheometer can configure the print out for several formats of paper/labels. These various paper/label stocks are available from Brookfield.

1. GV-1048 ADDRESS LABEL 1.13 X 3.5IN. 350 P/ROLL
2. GV-1049 SHIPPING LABEL 2.31 X 4IN. 300 P/ROLL)
3. GV-1047 CONTINUOUS PAPER 2.25IN. WD. X 300FT. LG



Figure II-8

Printer formats are detailed below:

### Data Label (Small)

03/04/13 12:09 PM		Administrator	
LV	LV-01	1.0 RPM	20.3 °C
900.0 ± 60.00 cP		15.0 %	



### Data Label (Large)

FINAL DATA POINT			02/21/13 10:08 AM
S/N: 206	RV	ULA	Administrator
Test: Unsaved Test			
<u>Visc(cP)</u>	<u>Acc(±cP)</u>	<u>Torq(%)</u>	<u>Speed(RPM)</u>
4.63	0.07	69.4	90
<u>Sh Stress(dyne/cm<sup>2</sup>)</u>		<u>Temp(°C)</u>	<u>Density(g/cm<sup>3</sup>)</u>
5.09		---	0.0000

TIP: When printing to a label, if the data set includes more than one point, only the last point will be printed.

### Data Continuous

VISCOSITY REPORT			Step Pt	Time	Viscosity	Torq	Speed	Sh Stress	Sh Rate	Temp	Density	Accuracy	
02/20/13 10:20 AM	Administrator		(#)	(#)	(hh:mm:ss)	(cP)	(%)	(RPM)	(dyne/cm <sup>2</sup> )	(1/s)	(°C)	(g/cm <sup>3</sup> )	(±cP)
S/N: 206	RV	LV-03	1	1	00:00:10	5,472	11.4	2.5	0.00	0.000	---	0.0000	480.00
Test: barbcomp16.dvt			2	2	00:00:20	5,472	45.6	10	0.00	0.000	---	0.0000	120.00
File: barbcompresults2.vdt			3	3	00:00:30	5,484	91.4	20	0.00	0.000	---	0.0000	60.00
Sample Notes:			4	4	00:00:40	5,532	46.1	10	0.00	0.000	---	0.0000	120.00
			5	5	00:00:50	5,616	11.7	2.5	0.00	0.000	---	0.0000	480.00

## III. MAKING VISCOSITY MEASUREMENTS

### III.1 Quick Start

The DV3T Rheometer uses the same methodology for viscosity measurements as the Brookfield Dial Reading Viscometers and DV series of Digital Viscometers. If you have experience with other Brookfield equipment, this section will give you quick steps for taking a viscosity reading. If you have not used a Brookfield Rheometer before, skip this section and go to Section III.2 for a detailed description.

- A) Assemble and level the DV3T Rheometer (Section I.4).
- B) Turn power on.
- C) Autozero the rheometer (Section II.2).
- D) The DV3T will display the Configure Viscosity Test Screen. In this screen, select spindle and speed. Confirm that Data Collection is set to Single Point and that End Condition is set to Time 00:00:00.
- E) Introduce the spindle into the sample and attach the spindle to the coupling nut.  
**NOTE: Left-hand thread.** If equipped with EZ-Lock, use the appropriate procedure to connect the spindle (see Section III.3).
- F) Press the Run button. The screen will change to the Running Viscosity Test Screen.
- G) When you are ready to record the measurement result, press the Stop Test button. The screen will change to the Results Table.
- H) Record the % torque and viscosity.
- I) To run another test, press Configure Test. To return to the Home Screen, press the Home Icon.

### III.2 Preparations for Making Measurements

- A) **RHEOMETER:** The DV3T should be turned on, leveled and autozeroed. The level is adjusted using the two feet on the bottom of the base and confirmed using the bubble level on the front of the head. Adjust the feet until the bubble is inside the center target. Set the level prior to autozero and check the level prior to each measurement.

**The proper level is essential for correct operation of the DV3T.**

- B) **SAMPLE:** The fluid to be measured (sample) must be in a container. The standard spindles supplied with the DV3T [LV (1-4), RV (2-7), or HA/HB (2-7)] are designed to be used with a 600 mL low form Griffin beaker (or equivalent container with a diameter of 8.25 cm). The same applies to the optional RV1, HA/HB1, and Vane spindles. Many other spindle systems are supplied from Brookfield with specific sample chambers such as the Small Sample Adapter, UL Adapter and Thermosel.

Brookfield recommends that you use the appropriate container for the selected spindle. You may choose to use an alternate container for convenience, however, this may have an effect on the measured viscosity. The DV3T is calibrated considering the specified container. Alternate containers will provide results that are repeatable but may not be “true”.

The LV (1-4) and RV (1-7) are designed to be used with the guardleg attached. Measurements made without the guardleg will provide repeatable results but may not provide “true” results.

**When comparing data with others, be sure to specify the sample container and presence/absence of the guardleg.**

Many samples must be controlled to a specific temperature for viscosity measurement. When conditioning a sample for temperature, be sure to temperature control the container and spindle as well as the sample.

Please see our publication, “More Solutions to Sticky Problems”, for more detail relating to sample preparation.

### III.3 Programming

The DV3T Rheometer provides a powerful programming capability for data collection. The interface in Configure Viscosity Test allows for control of all instrument parameters including Spindle, Speed, Temperature (optional), End Condition, Data Collection, Instructions, Reports, Density, and QC Limits (described in the next sections of this chapter). Any collection of these parameters is considered a Test Step. The DV3T allows you to create multiple steps to better evaluate your sample material. Several parameters are only active in the first step including Spindle and Instructions.

Multiple steps in a Test can be useful to evaluate the rheology of a sample or to simply aid in data collection. A multi step Test that has a change in speed in each step can show Newtonian or non Newtonian flow behavior. A first step with No Data can be useful when pre shearing is required. A step with No Data can be useful when a temperature change is effected and some time is required for thermal equilibrium.

The Configure Viscosity Test screen (see Figure III-1) includes several tools for creating Tests with multiple steps.



**Figure III-1**

- |  |                   |                                                                                            |
|--|-------------------|--------------------------------------------------------------------------------------------|
|  | Navigation / Add: | Use the  to add a new step at the end of the Test. Use the  to navigate to previous steps. |
|  | Delete:           | Delete the current step.                                                                   |
|  | Insert:           | Insert a new step after the current step.                                                  |

Two multi step Tests are shown below. The first test shows a three step test where each step has a different speed with a single data point collection. The results will include three viscosity points, one for each speed. The second test shows a two step test where the first step is a pre shear step. The pre shear is conducted at 200 rpm for one minute and no data is collected. The second step generates a single data point.

### Three Step Test:



Figure III-2a: Step 1



Figure III-2b: Step 2



Figure III-2c: Step 3

### Two Step Test:



Figure III-3a: Step 1



Figure III-3b: Step 2

## III.4 Selecting a Spindle/Speed

The DV3T has the capability of measuring viscosity over an extremely wide range. For example, the DV3TRV can measure fluids within the range of 100-40,000,000 cP. This range is achieved through the use of several spindles over many speeds. See Appendix B for details.

The process of selecting a spindle and speed for an unknown fluid is normally trial and error. **An appropriate selection will result in measurements made between 10-100 on the instrument % torque scale.** There are two general rules that will help in the trial and error process:

- 1) Viscosity range is inversely proportional to the size of the spindle.
- 2) Viscosity range is inversely proportional to the rotational speed.

In other words: to measure high viscosity, choose a small spindle and/or a slow speed. If the chosen spindle/speed results in a reading above 100%, then reduce the speed or choose a smaller spindle.

Experimentation may reveal that several spindle/speed combinations will produce satisfactory results between 10-100%. When this circumstance occurs, any of the spindles may be selected.

Non-Newtonian fluid behavior can result in the measured viscosity and yield stress changing if the spindle and/or speed is changed. See our publication, “More Solutions to Sticky Problems”, for more details.

**When viscosity data must be compared, be sure to use the same test methodology: namely the same instrument, spindle, speed, container, temperature and test time.**

DV3TLV Rheometers are provided with a set of four spindles and a narrow guardleg; DV3TRV Rheometers come with a set of six spindles and a wider guardleg; DV3THA and DV3THB Rheometers come with a set of six spindles and **no guardleg**. (See Appendix G for more information on the guardleg.)

The spindles are attached to the rheometer by screwing them onto the coupling nut on the lower shaft (see Figure III-4). Note that the spindles have a left-hand thread. The lower shaft should be secured and slightly lifted with one hand while screwing the spindle to the left. The face of the spindle nut and the matching surface on the lower shaft should be smooth and clean to prevent eccentric rotation of the spindle. Spindles can be identified by the number on the side of the spindle coupling nut.

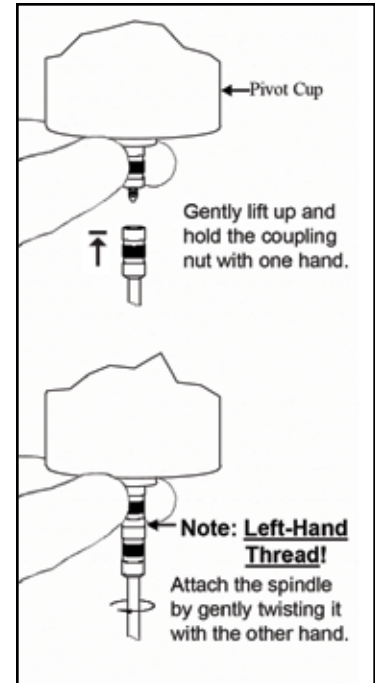



Figure III-4

 The motor should be OFF whenever spindles are being removed or attached.

If your instrument has the EZ-Lock system, the spindles are attached as follows:

With one hand hold the spindle, while gently raising the spring-loaded outer sleeve to its highest position with the other hand, as shown in Figure III-5. Insert the EZ-Lock Spindle Coupling so that the bottom of the coupling is flush with the bottom of the shaft, and lower the sleeve. The sleeve should easily slide back down to hold the spindle/coupling assembly in place for use. [Spindles can be identified by entry code; look for the number on the side of the EZ-Lock spindle coupling.]

 The motor should be OFF whenever spindles are being removed or attached.

*Note:* Keep the EZ-Lock Spindle Coupling and outer sleeve as clean as possible and free from debris that could become lodged inside the adapter.

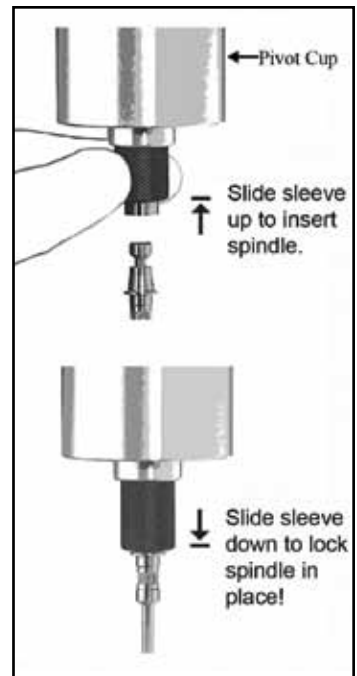

Figure III-5

### III.5 Temperature Control

The DV3T Rheometer provides the ability to control the temperature of a connected Brookfield temperature control device such as the Thermosel (HT-106 controller) and water baths with SD or AP controllers (for example: TC-550SD). The Thermosel or water bath can then be used to control the temperature of the sample under test.

The DV3T connects to the temperature control device through a dedicated communication cable. The Thermosel requires cable DVP-141. The water baths require cable DVP-207. These cables are available from Brookfield.

When configured for control of a temperature control device, the DV3T may have two temperature inputs;

- 1) the temperature probe supplied with the DV3T (DVP-94Y, CPA-44PYZ, or SC4-13RPY) and
- 2) the temperature probe supplied with the temperature control device (water bath or Thermosel).

Only one temperature probe can be used for display of live temperature, control, and data collection. Select the probe to be used in the Temperature menu (see Figure III-6).

**TIP:** Embedded temperature probes used with the Cone/Plate and Small Sample Adapter can be used for set point control of a water bath. Making this selection can improve the temperature control of the sample by off setting the temperature bath to account for any heat loss in the tubing or water jacket. To use the embedded temperature probe, select Probe in the Temperature menu.

Temperature control must be initiated each time the DV3T is powered on. Be sure that the temperature control device is powered on prior to initiating communication. Chose Device Setup in the Settings menu. Chose Temperature and you will be presented with the Temperature menu (see Figure III-6). Temperature Offset is described in Section IV.1.



**Figure III-6**

Select Temperature Controller and you will be presented with the Default Temperature menu (see Figure III-7). This menu allows the user to 1) initiate communication with the temperature controller and 2) set a default temperature.

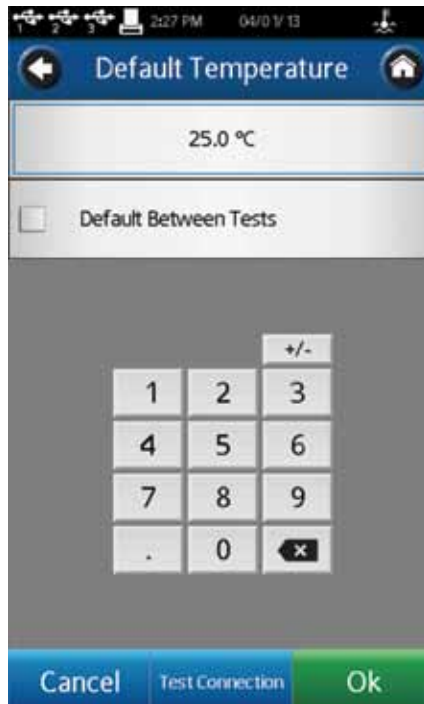

**Figure III-7**

Initiate temperature control by pressing the Test Connection. The connection status will be confirmed with a message box and the appearance of the bath icon in the status bar (see Section II.3).

The Default Temperature is the temperature value that the control device will return to at the conclusion of a Test. This value is set only if the check box is checked. When the check box is unchecked, the temperature controller will hold at the last set point used in the Test.

**TIP:** When a test involves several temperature set points, set the Default Temperature to the first set point used in the Test. This will reduce the transition time from one Test run to the next Test run.

Note that temperature controllers can also be controlled through the Rheocalc T software when they are connected to the computer using the proper cable. The Thermosel requires the HT-106 cable (RS-232), available from Brookfield. The water bath requires the 225-173 cable (RS-232), which comes with the bath.

### **III.6 Multiple Data Points**

The majority of viscosity and yield stress measurements are made at the quality control level and often consist of a single data point. The test is conducted with one spindle at one speed. The data point is a useful bench mark for the go/no-go decision in a production setting. The DV3T can be used for single point measurement.

Many fluids exhibit a characteristic change in viscosity and yield stress with a change in applied force. This non-Newtonian flow behavior is commonly seen in paints, coatings and food products as a decrease in viscosity as shear rate increases or an increase in yield stress as a rotational speed increases. This behavior cannot be detected or evaluated with the single point measurement.

Non-Newtonian flow is analyzed through the collection of viscosity data over a range of shear rates and the generation of a graph of viscosity versus shear rate (a rheogram). This information will

allow for a more complete characterization of a fluid and may help in formulation and production of a product. The DV3T is capable of collecting multiple data points for comprehensive analysis of flow behavior.

More information on flow behavior, shear rate and rheograms is available in our publication, “More Solutions to Sticky Problems”.

### III.7 Selecting Data Collection

The DV3T Rheometer offers several options for data collection. The Data Collection setting is shown in Configure Viscosity Test directly under the Temperature display. The factory setting is Single Point (see Figure III-8). Pressing the blue arrow, in this field, will present the Data Collection screen (see Figure III-9).



Figure III-8



Figure III-9

**Single Point:** Collect only a single data point when the End Condition is met.

**Single Point Averaging:** Specify an amount of time over which to average measured data. Collect a single data point when the End Condition is met. This data point is an averaged value. If the time for averaging is shorter than the total time for the step, then the average will be performed for the specified time at the end of the test.

Example 1: The End Condition is Time with a value of 1 minute and 30 seconds, the Single Point Averaging Duration is 30 seconds, the single data point collected from this step will be an average of the data measured from 1 minute to 1 minute 30 seconds.

**Multi Point:** Collect multiple data points based on time. The Data Interval is specified in Hours:Mins:Secs. If the End Condition is set to Time, then the total number of



points will be calculated and displayed in the Data Collection screen. If the End Condition is not based on time then it is possible that the step will conclude prior to a data point being collected. If you want a data point at the conclusion of the step regardless of the time interval, you can check the check box in the Data Interval screen.

Example 2: End Condition is Time = 2 minutes, Multi Point Data Interval is 10 seconds. Total points collected will be 12 with the last data point taken in the last second of the step.

Example 3: End Condition is set to Viscosity = 200 cP, Multi Point Data Interval is 10 seconds. During the test the total time required to reach 200 cP is 65 seconds. Total points collected will be 6 with the last data point taken at 60 seconds, 5 seconds before the test is finished.

Example 4: End Condition is set to Viscosity = 200 cP, Multi Point Data Interval is 10 seconds. Check the check box to Also Collect Single Point at Step End. During the test, the total time required to reach 200 cP is 65 seconds. Total points collected will be 7 with the last data point taken at 65 seconds, 5 seconds after point #6 taken at 60 seconds.

**Multi Point Averaging:** Specify an amount of time over which to average measured data. Collect multiple data points based on time until the End Condition is met. Each data point is an averaged value. If the Averaging Duration is shorter than the Data Interval for the step, then the average will be performed for the specified time at the end of the Data Interval. The total number of points to be collected will be displayed if the End Condition is set to Time. If the End Condition is not based on time, then it is possible that the step will conclude prior to a data point being collected. If you want a data point at the conclusion of the step regardless of the time interval, you can check the check box in the Data Interval screen.

Example 5: End Condition is Time = 2 minutes, Multi Point Data Interval is 10 seconds. Averaging Duration is 5 seconds. Total points collected will be 12 with the last data point taken in the last second of the step. Each data point will be an average of the data measured in the last 5 seconds of each Data Interval.

Example 6: End Condition is set to Viscosity = 200 cP, Multi Point Data Interval is 10 seconds. Averaging Duration is 5 seconds. During the test, the total time required to reach 200 cP is 63 seconds. Total points collected will be 6 with the last data point taken at 60 seconds, 3 seconds before the test is finished. Each data point will be an average of the data measured in the last 5 seconds of each Data Interval.

Example 7: End Condition is set to Viscosity = 200 cP, Multi Point Data Interval is 10 seconds. Averaging Duration is 5 seconds. Check the check box to Also Collect Single Point at Step End. During the test, the total time required to reach 200 cP is 65 seconds. Total points collected will be 7 with the last data point taken at 65 seconds, an average of the 5 seconds after point #6.

Example 8: End Condition is set to Viscosity = 200 cP, Multi Point Data Interval is 1 minute. Averaging Duration is 20 seconds. Check the check box to Also Collect Single Point at Step End. During the test, the total time required to reach 200 cP is 10 minutes 40 seconds. Total points collected will be 11 with the last data point taken at 10 minutes 40 seconds, an average of the last 20 seconds of the step.

**No Data:** End Condition is met and no data is collected.

### III.8 End Condition

The completion of a test is defined by the End Condition. Each time that you enter Configure Viscosity Test, the End Condition will be set to the last value used. The End Condition parameter or values can be changed by pressing the End Condition button.

Within the End Condition screen, the currently selected End Condition parameter and values are displayed. The End Condition can be changed by pressing the blue down arrow within the parameter field. Six End Conditions are available: Time, # of Points, # of Revolutions, Torque, Viscosity, Temperature (see Figure III-10).

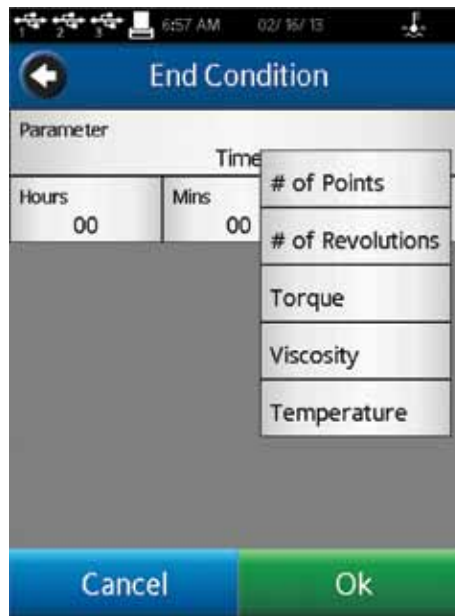

Figure III-10

**Time:** The test will complete when the specified amount of time has elapsed. Time is entered in Hours, Minutes, and Seconds.

Hours: 0-99

Minutes: 0-59

Seconds: 0-59

A time of zero hours, minutes and seconds may be selected. With this End Condition, the DV3T will operate at the selected speed until the operator selects Stop Test. Data will be collected according to the Data Collection setting (see Section III.7).

TIP: An End Condition of zero Time can be useful when measuring a new material. During the test, the speed can be changed without ending and then rerunning the test (see Section III.10). This method can allow you to quickly evaluate the spindle selection to determine the best speeds for testing.

**# of Points:** The test will complete when the specified number of data points has been collected. Data is collected according to the Data Collection setting (see Section III.6). The range of data points is: 1 – 9,999.

**# of Revolutions:** The test will complete when the specified number of revolutions of the spindle has occurred. Data is collected according to the Data Collection setting (see Section III.6). The range for number of revolutions is: 1 – 9,999.

**Torque:** The test will complete when the specified Torque value is measured. Data is collected according to the Data Collection setting (see Section III.6). The range of values for the measured Torque is: -10.0 – 100.0.

**Viscosity:** The test will complete when the specified Viscosity value is measured. Data is collected according to the Data Collection setting (see Section III.6). The range of measured Viscosity is 0 – 10,000,000,000 cP.

Note: The Viscosity End Condition should be selected in consideration of the Range provided by the spindle and speed selected. Check the Range value by selecting Spindle in Configure Viscosity Test. If you choose a Viscosity End Condition greater than the Range of the spindle and speed settings, then the value shown in the End Condition field will be EEEE. In this case, the end condition will never be achieved.

**Temperature:** The test will complete when the specified Temperature value is measured to within the indicated Tolerance. The Tolerance specifies how close the measured temperature should be to the specified temperature value to consider the target reached. Temperature is measured through the use of a connected Brookfield temperature probe (DVP-94Y, CPA-44ZPY cup, SC4-XXRPY chamber). Data is collected according to the Data Collection setting (see Section III.6).

Temperature: -100 – 300 C

Tolerance: 0.0 – 9.9 C

TIP: A small tolerance value will require a much longer time to reach the End Condition.

TIP: Consider using a larger Tolerance value for the End Condition and then use a second step for thermal equilibrium (End Condition Time). This two step method can reduce the variability in test time caused by variations in temperature sensors.

### III.9 Additional Test Parameters

The Configure Viscosity Test screen includes a More/Less Bar. When pressed, the More Bar will present several additional Test Parameters including: QC Limits, Instructions, Reports, and Density. These parameters are always available and active regardless of the position of the More / Less Bar.

**QC Limits:** Select an acceptable range for measurement results. The range may be defined by Viscosity, Torque, Time, Temperature, or Shear Stress. The possible range for Viscosity and Shear Stress will be defined by the spindle and speed selected. QC Limits are a visual and audible signal to the operator during the test. The data set does not include an indication of QC Limits violation.

A violation of the QC Limits during the test will be indicated by a flashing yellow box around the display for the specified parameter. Note that Time does not have a dedicated display. A violation will also result in an audible beep and a one time warning message (see Figure III-11). Data will continue to be collected while the warning message is displayed.

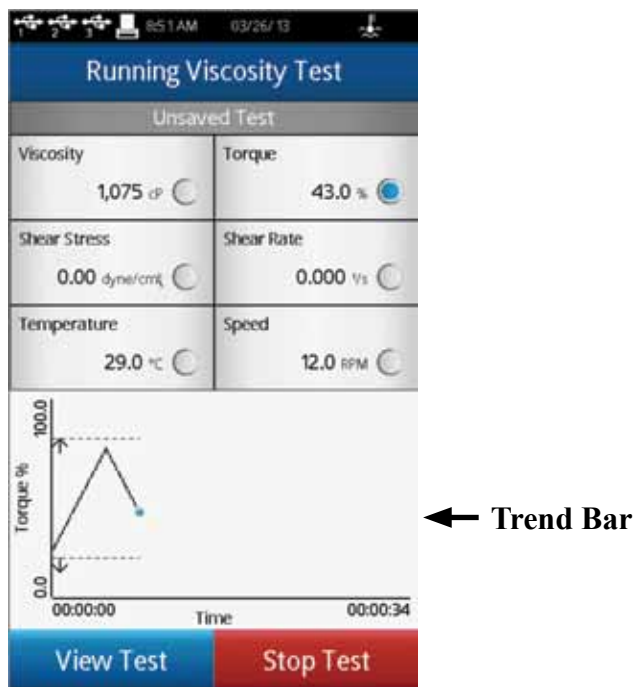

**Figure III-11**

When Viscosity or Torque are the selected QC Limits parameter, QC Limits will be shown during the test on the Real Time Graph if that parameter is selected for display (see Figure III-12). The QC Limits are represented by the dashed lines.

TIP: Audible alarms may be turned off in the User Settings .

TIP: An indication of a QC Limit violation is not part of the data set. The user can record a violation by using the Notes available when viewing test Results (see Section III.11).



**Figure III-12**

**Instructions:** Record specific instructions to the operator. This information will be presented immediately when the program is Run (see Figure III-13). The operator is required to acknowledge the message before the program will continue.



**Figure III-13**

TIP: If the operator selects “Do not show this message again” within the Instructions message box, then Instructions will no longer be displayed for any test. This condition can be reset to allow Instructions to be displayed in the Display section of User Settings .

TIP: Instructions can be viewed during the test by selecting instructions (more/less bar) in the View Test screen.

**Reports:** Define how data will be presented at the conclusion of the test and specify the path for saving data files. Upon the conclusion of a test, the user can be presented with either: a Graph, Table, Math Model, or an Average of collected data points. Once in the Results section, the down arrow  can be used to change the view.

Post Test Averaging can be specified as either Test Averaging or Step Averaging. Test Averaging allows you to select which step from the program (created with PG Flash) is to be averaged and displayed. Step Averaging is used when there is a single test step. See Section III.10 for more detail relating to Data Averaging.

The data path for saving data can be preselected as part of the test report.

TIP: Selecting a data path can help to organize data storage in the internal memory of DV3T. By preselecting the data path, operators are directed to put data from specific tests into specific areas.

TIP: If you select a data path that includes a USB Flash Drive location and the USB Flash Drive has been removed, an error message will be displayed.

**Density:** Input a density value for the sample to be tested. This value will be used to calculate viscosity when kinematic viscosity units have been chosen for display (see Section V.4.2).

### III.10 Running a Test

A viscosity test is started by pressing the Run button on the Configure Viscosity Test screen. When Run is pressed, the display will change to the Running Viscosity Test screen (see Figure III-14).

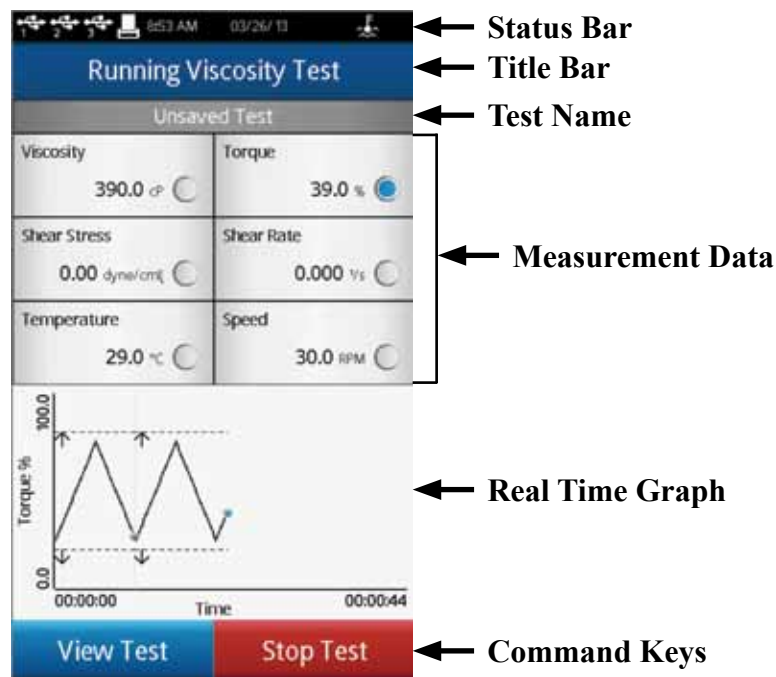



Figure III-14

The Running Viscosity Test screen provides information on the current measurement including: Torque, Viscosity, Shear Stress, Shear Rate, Temperature and Speed.

**Torque** is the deflection of the Rheometer torque sensor. It is described as a percent (%) and has a range of 0 – 100%. The DV3T will provide measurement results within the stated accuracy provided the Torque reading is between 10 and 100%. If the Torque reading falls below 10% the labels in the data fields will flash to indicate an error condition. Brookfield does not recommend that data be collected below 10% Torque; however, data collection is not restricted.

TIP: Torque on the DV3T is equivalent to the dial reading from the Brookfield Dial Reading Viscometer or the % reading from Brookfield Digital Viscometers (DV-E, DV-I, DV-II, DV-III).

**Viscosity** is calculated from the measured Torque based on the selected spindle and speed of rotation. The units of viscosity are defined in the Global Settings section of the Settings Menu . If the Torque reading falls below 10%, the labels in the data fields will flash to indicate an error condition.

**Shear Stress** is calculated from the measured Torque based on the selected spindle. The units of shear stress are defined in the Global Settings section of the Settings Menu . If the Torque reading falls below 10%, the labels in the data fields will flash to indicate an error condition.

TIP: Shear Stress will be displayed as zero for spindles that do not have SRC values.

**Shear Rate** is calculated from the selected speed based on the selected spindle.

TIP: Shear Rate will be displayed as zero for spindles that do not have SRC values.

**Temperature** is the input value from a connected Brookfield temperature probe. The DV3T is provided with a DVP-94Y probe that can be inserted into the test sample or a water bath. The Cone/Plate version of the DV3T can be utilized with a sample cup that includes an embedded temperature probe. Some Brookfield accessories include temperature probes (Thermosel) or optional chambers with embedded temperature probes (Small Sample Adapter). The units of temperature are defined in the Global Settings section of the Settings Menu .

The temperature display will be ---- when no temperature probe is connected.

**Speed** is the selected speed from the Configure Viscosity Test screen.

TIP: Speed can be changed by switching from the Running Viscosity Test screen to the View Test screen using the command key at the bottom of the screen.

TIP: When Speed is changed in the View Test screen, the Test Name will be changed to unsaved.

The status of the test configuration is indicated in the grey bar above the data fields. A configuration that has been saved will be indicated by a display of the test file name. A configuration that is not saved will be indicated by a display of Unsaved Test.

The **Real Time Graph** is displayed at the bottom of the Running Viscosity Test screen. This graph shows all measurements during the life of the test. The Y-axis can represent any data field. The data field represented on the graph is shown by the blue dot; for example, in Figure III-14, Torque is shown on the graph. Any data field can be selected by touching the screen.

The Real Time Graph will indicate data points collected as part of the test with a blue dot on the data line. At the conclusion of the test, the Real Time Graph is displayed for review. Once the OK button is pressed, only the data points collected as part of the test will be available for review/save. The Real Time Graph cannot be seen again once the Results page is in view.

QC Limits will be indicated on the Real Time Graph when the selection for Y-Axis is the same as the selection for QC Limits (see Section III.9).

Two Command Keys are available on the Running Viscosity Test screen: Stop Test and View Test.

**Stop Test:** Immediately stops the current test. The user will be presented with a confirmation box. The test will continue to run until Yes is selected in the Confirmation box. If any data had been collected during the test, the user will be presented with the Results screen (see Section III.11). If data was not collected, the user will be returned to the Configure Viscosity Test screen.

TIP: If the operator selects “Do not show this message again” within the Confirmation box, then the Confirmation box will no longer be displayed when Stop Test is pressed. This condition can be reset in the Display section of User Settings .

**View Test:** Change the view from measurement to test parameters including: Spindle, Speed, Temperature, End Condition, Data Collection, QC Limits, Instructions, and Density. The View Test screen includes a live display of Torque and a Time parameter that shows the total elapsed time for the test (see Figure III-15).

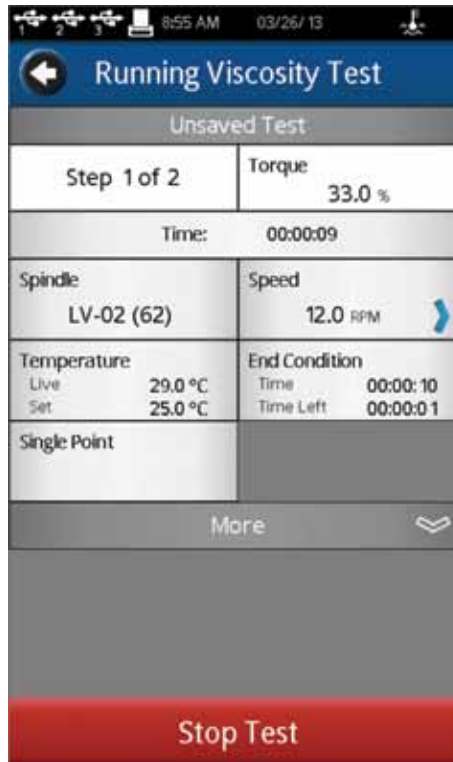

**Figure III-15**

The More/Less Bar can be used to reduce the number of parameters shown in the display.

The Speed parameter is active in this view. The operator can change the speed of test without returning to the Configure Viscosity Test screen.

TIP: If the speed is changed during the execution of a saved test, then the test status will be changed to “Unsaved Test”. This will also be reflected if the collected data is saved.

View Test includes the Stop Test command key and a Back Arrow navigation key. The Back Arrow is used to return the display to the Running Viscosity Test view.

### III.11 Results







Measurement data is viewed in the Results screen. This screen is presented at the conclusion of a test or when data is loaded through the View Results selection from the Home Menu.

The DV3T utilizes a comprehensive data format. Data files include the complete set of measurement results and calculated values along with the test protocol. All elements of the test can be viewed in the Results screen.

The DV3T Rheometer allows for 5000 total data points per file. When viewing large data files, additional time is required when moving from the various Results options listed below. There may be some delay on the screen while the DV3T prepares the data.



The Results screen includes several Navigation Icons and Command Keys.

-  Home: Return to the Home Menu.
-  Down Arrow: Select Results Options.
-  Blue Arrow: Select Page of Results Table.
-  Print: Print Data to USB printer.
-  Save: Save data.
-  Configure Test: Return to Configure Viscosity Test screen.
-  Scroll Bar: Move up/down through a page of data.

The Results screen offers several options for viewing test data. These options are accessed via the Down Arrow in the Navigation Bar at the top of the screen (see Figure III-16).

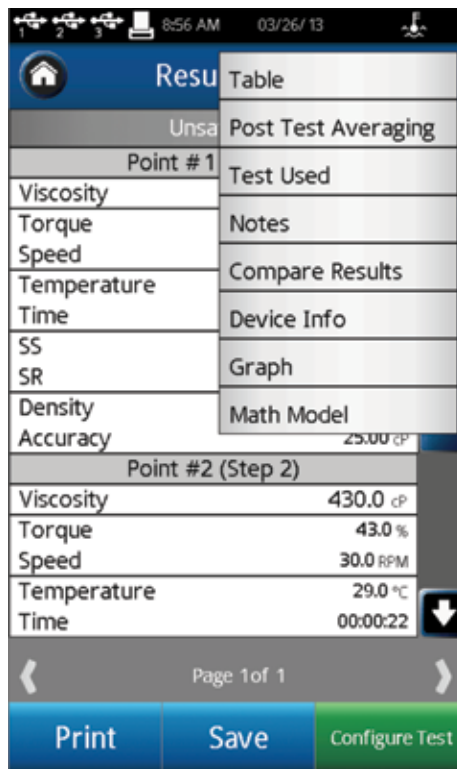

Figure III-16

**Table:** Display all data points. Data will be shown in a scroll list where each page can hold a maximum of 50 points. If the data set has more than 50 points, then additional pages will be indicated at the bottom of the screen. Additional pages of data can be accessed through the use of the Blue Arrows

Each data point includes: Viscosity, Torque, Speed, Temperature, Time, Shear Stress (SS), Shear Rate (SR), Density, and Accuracy.

**Post Test Averaging:** Average and Standard Deviation are calculated for measured and calculated parameters including: Viscosity, Torque, Shear Stress, and Temperature.

Post Test Averaging is calculated regardless of the Data Collection setting. If Data Collection was set to Multipoint Averaging, then the Post Test Averaging will calculate an average of the averaged data.

When using multiple step programs, the test step utilized for Post Test Averaging is specified in the Report setting (see Section III.9).

**Test Used:** Display the test elements used to generate the data set. In this view, the Configure Test button is available. Selecting Configure Test will program the DV3T to run the same test utilized to collect the data set being viewed and present the Configure Viscosity Test screen.

**Notes:** Document any relevant information about the test or data. This information will be stored with the data set once saved.

**Compare Results:** Load two data sets and view side by side.

5 speed ramp high.vdt		5 speed ramp L...	
Point # 1 (Step 1)		Point # 1 (Step 1)	
Viscosity	37.95 cP	24.30 cP	
Torque	25.3 %	16.2 %	
Speed	20 RPM	20 RPM	
Temperature	20.1 °C	20.0 °C	
Time	00:00:30	00:00:30	
SS	10.02 dyne/cm <sup>2</sup>	6.42 dyne/cm <sup>2</sup>	
SR	26.40 1/s	26.40 1/s	
Density	0.0000 g/cm <sup>3</sup>	0.0000 g/cm <sup>3</sup>	
Accuracy	150 cP	150 cP	
Point #2 (Step 2)		Point #2 (Step 2)	

Page 1 of 1

Save    Configure Test

Figure III-17

**Device Info:** Display basic information about the data file and the specific DV3T Rheometer used to collect the data including: date and time the test started, completed and was saved; if user accounts are active, which user saved the data; rheometer serial number, firmware version, rheometer Torque range (LV, RV, HA, HB, other).

**Graph:** Display a graph of the collected data. The axis will default to the values selected in the Report section of the Test. The value displayed on each axis can be changed by selecting from the blue drop down arrow in each field. Individual data points can be selected and the X / Y coordinate values will be displayed. The selected point is represented by a blue dot (other points are shown as grey dots).

TIP: Some spindle selections do not allow for the calculation of shear stress and shear rate. Shear Stress and Shear rate will be represented as zero for all data points for this type of spindle.

TIP: If the temperature probe is not connected to the DV3T, then the temperature field will not contain any data. The Graph will not display temperature under this condition.

The Graph can be printed if there is an attached printer. The buttons at the bottom of the graph are for zooming in, zooming out, and resetting.

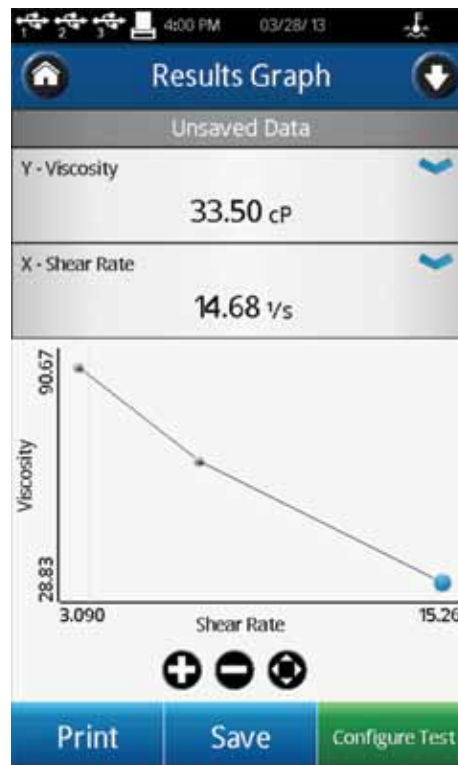

**Figure III-18**

**Math Model:** Analyze collected data through several defined equations. The selected math model will default to the selection from the Report section of the Test. You can change the selected model by pressing the blue drop down arrow.

Math Models available on the DV3T Rheometer include Bingham, Casson, NCA/CMA Casson, Power Law, IPC Paste, and Thix Index. Each Math Model will be displayed in equation form with parameter values and confidence of fit calculations shown. Additionally, a graph of the model will be shown when available (no graph is available for Thix Index). The graph is a visual aid only and will not be included with a print.

Figure III-19 shows the Power Law equation for a typical set of data. A brief definition of the equation will be shown if the “i” (information) button is pressed.

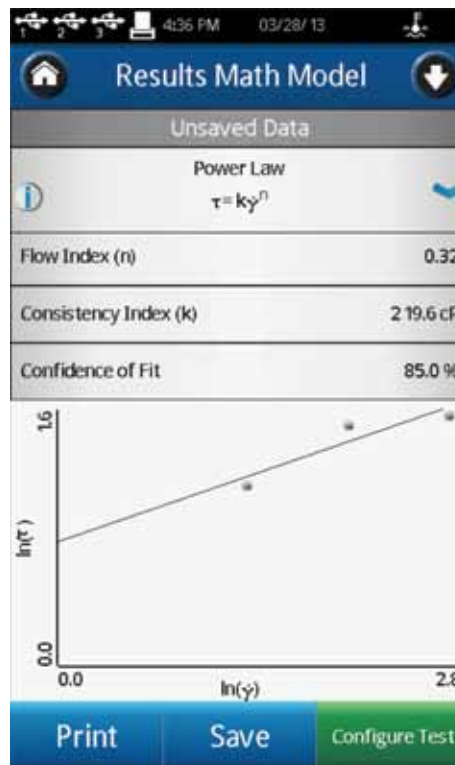

Figure III-19

Detailed information about Math Models is presented in Section VII.

### III.12 Data Averaging

The DV3T Rheometer offers two techniques to average data, Live Averaging and Post Test Averaging. Data averaging can be useful when measuring samples with entrained air or suspended particles that cause some variation in measurement results. Data averaging may not be useful when changes in measurement results are caused by the rheological properties of the test sample such as thixotropy or pseudoplasticity (shear thinning). Materials that exhibit thixotropy will show a steadily decreasing measured viscosity over time. Materials that exhibit pseudoplasticity will show a changing viscosity as the spindle speed changes.

**TIP:** When averaging data for a thixotropic material, begin the Averaging Duration after the period of most significant change in measured viscosity. This will reduce the variability in the averaged value.

**TIP:** When averaging data for a pseudoplastic material, do not average together (Test Averaging) data collected at different speeds (or shear rates).

Live Averaging of data occurs during actual testing of a sample. Data can be collected as an average of readings over a specific time interval; each data point saved in the file is an averaged value. This averaging is defined in the Data Collection section of Configure Viscosity Test.

**Single Point Averaging** requires a definition of Averaging Duration, the amount of time for which readings will be averaged. This time parameter will be applied at the end of the End Condition. In this case a single data point will be collected which represents the average of all data measured during the specified time period (Averaging Duration).

**Multi Point Averaging** requires a definition of 1) Data Interval, the frequency of data collection and 2) Averaging Duration, the amount of time for which readings will be averaged. These two parameters will work in conjunction to generate multiple data points each of which represent the average of all data measured during the average duration within the specified Data Interval.

Post Test Averaging of data occurs after the test is complete, through the Results screen. Averages and standard deviation values can be generated for data collected in a single step or across several steps. If the test used to collect data utilized Live Averaging (described above), then the Post Test Averaging will produce an average value of averaged data points.

Post Test Averaging can be specified in the Report section of Configure Viscosity Test (see Section III.9). When configured as part of the test, the average values will be displayed immediately upon test conclusion. If not specified in Report, Post Test Averaging can be selected from the Down Arrow in the Results screen (see Section III.11).

Post Test Averaging offers two options: Step Averaging and Test Averaging (see Figure III-20).

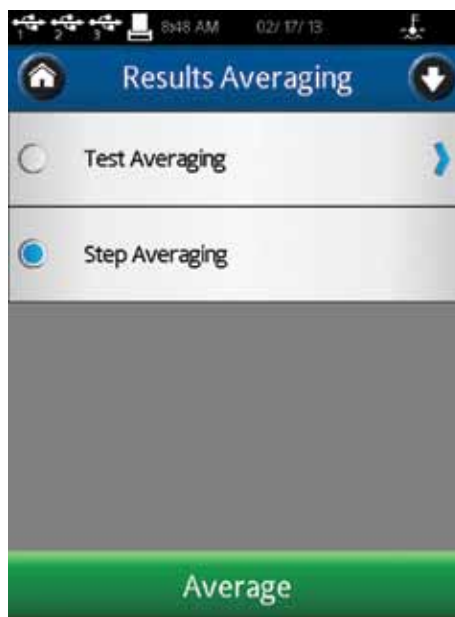

**Figure III-20**

**Step Averaging:** Calculate Average and Standard Deviation for all data collected within a single step test. Step Averages will be displayed as shown below in Figure III-21.

Step 1 of 1			
Viscosity	9.88 cP	Torque	49.4 %
Std. Dev.	2.91 cP	Std. Dev.	14.6 %
Shear Stress	3.63 dyne/cm <sup>2</sup>	Temperature	29.0 °C
Std. Dev.	1.07 dyne/cm <sup>2</sup>	Std. Dev.	0.0 °C
Shear Rate	36.69 1/s	Density	0.0000 g/cm <sup>3</sup>
Speed	30 RPM	Accuracy	0.20 cP

**Figure III-21**

**Test Averaging:** Calculate Average and Standard Deviation for all data collected within step specified. Test Averages will be displayed as shown below in Figure III-22.

Viscosity	9.88 cP
Standard Deviation	2.91 cP
Torque	49.4 %
Standard Deviation	14.6 %
Shear Stress	3.63 dyne/cm <sup>2</sup>
Standard Deviation	1.07 dyne/cm <sup>2</sup>
Temperature	29.0 °C
Standard Deviation	0.0 °C
Speed	30 RPM
Standard Deviation	0.0 RPM
Shear Rate	36.69 1/s
Standard Deviation	0.049 1/s
Density	0.0000 g/cm <sup>3</sup>

**Figure III-22**

## IV. MAKING YIELD MEASUREMENTS

### IV.1 Quick Start

The DV3T Rheometer uses the same methodology for yield measurements as the Brookfield YR-1 and DV-III Ultra Rheometers. If you have experience with other Brookfield equipment, this section will give you quick steps for making a yield measurement. If you have not used a Brookfield Rheometer before, skip this section and go to Section IV.2 for a detailed description.

- A) Assemble and level the DV3T Rheometer (Section I.4).
- B) Turn power on.
- C) Autozero the rheometer (Section II.2).
- D) The DV3T will display the Configure Viscosity Test Screen. Press the Home Icon in the Navigation Bar. From the Home Menu, select Configure Yield Test.
- E) Select: Spindle, Immersion Mark, and Run Speed.
- F) Attach the vane spindle to the DV3T.  
**NOTE: Left-hand thread.** If equipped with EZ-Lock, use the appropriate procedure to connect the spindle (see Section III.3). Immerse the spindle gently into the test sample by lowering the DV3T on the Model G laboratory stand.
- G) Press the Run button. The screen will change to the Running Yield Test Screen.
- H) When the Yield Test is complete, the DV3T will present the Yield Test Complete screen. Record the Stress (yield stress), Torque, and Temperature.
- I) To run another test, press Configure Test. To return to the Home Menu, press the Home Icon.

### IV.2 Preparations for Making Measurements

- A) RHEOMETER: The DV3T should be turned on, leveled and autozeroed. The level is adjusted using the two feet on the bottom of the base and confirmed using the bubble level on the front of the head. Adjust the feet until the bubble is inside the center target. Set the level prior to autozero and check the level prior to each measurement.

**The proper level is essential for correct operation of the DV3T.**

- B) Sample: The measured yield value is very dependent on how the sample is handled prior to the measurement. The sample should be disturbed as little as possible prior to inserting the vane spindle. Brookfield recommends testing the sample in the container in which it is provided when possible. If it is necessary to transfer the sample to a new container, then it is recommended to include a pre-shear and/or wait time in the Yield Test. This pre-shear and wait-time will provide a common history to each sample to aid in sample to sample comparison.

Brookfield recommends the use of vane spindles for measuring yield value. The vane spindle provides a unique geometry that minimizes disturbance of the sample during spindle insertion.

Many samples must be controlled to a specific temperature for yield measurement. When conditioning a sample for temperature, be sure to temperature control the container and spindle as well as the sample.

### IV.3 Selecting a Spindle/Speed

The DV3T has the capability of measuring yield stress over an extremely wide range. For example, the DV3TRV can measure fluids within the range of 0.5-400 Pa. This range is achieved through the use of several vane spindles over many speeds. See Appendix B for details.

The process of selecting a spindle and speed for an unknown fluid is normally trial and error. **An appropriate selection will result in measurements made between 10-100 on the instrument % torque scale.** There are two general rules will help in the trial and error process:

- 1) Viscosity range is inversely proportional to the size of the spindle.
- 2) Viscosity range is inversely proportional to the rotational speed.

In other words: to measure high yield, choose a small spindle and/or a slow speed. If the chosen spindle/speed results in a reading above 100%, then reduce the speed or choose a smaller spindle.

Experimentation may reveal that several spindle/speed combinations will produce satisfactory results between 10-100%. When this circumstance occurs, any of the spindles may be selected.

**When yield data must be compared, be sure to use the same test methodology: namely the same instrument, spindle, speed, container, temperature and test time.**

Vane spindles are optional equipment and are not part of the standard DV3T package. DV3TLV Rheometers are provided with a set of four spindles and a narrow guardleg; DV3TRV Rheometers come with a set of six spindles and a wider guardleg; DV3THA and DV3THB Rheometers come with a set of six spindles and **no guardleg**. (See Appendix G for more information on the guardleg.) **Do not use the guard leg with vane spindles.**

The spindles are attached to the rheometer by screwing them onto the coupling nut on the lower shaft (see Figure IV-1). Note that the spindles have a left-hand thread. The lower shaft should be secured and slightly lifted with one hand while screwing the spindle to the left. The face of the spindle nut and the matching surface on the lower shaft should be smooth and clean to prevent eccentric rotation of the spindle. Spindles can be identified by the number on the side of the spindle coupling nut.

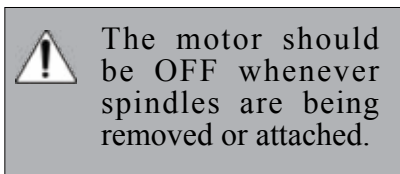

If your instrument has the EZ-Lock system, the spindles are attached as follows:

With one hand hold the spindle, while gently raising the spring-loaded outer sleeve to its highest position with the other hand, as shown in Figure IV-2. Insert the EZ-Lock Spindle Coupling so that the bottom of the coupling is flush with the bottom of the shaft, and lower the sleeve. The sleeve should easily slide back down to hold the spindle/coupling assembly

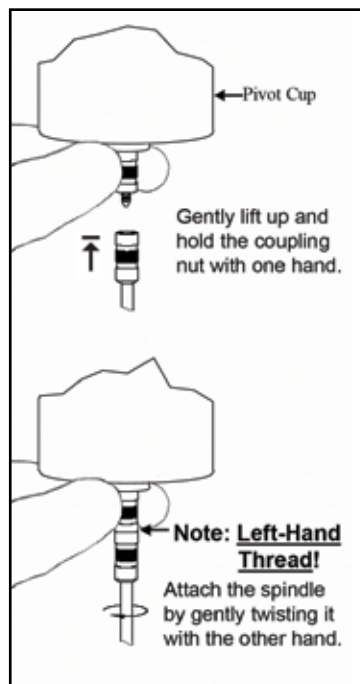

Figure IV-1

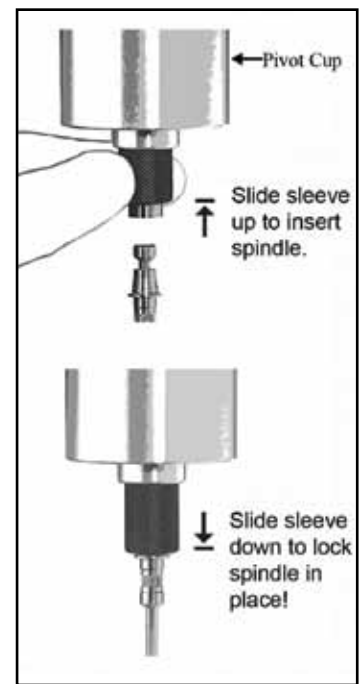

Figure IV-2



in place for use. [Spindles can be identified by entry code; look for the number on the side of the EZ-Lock spindle coupling.]

*Note:* Keep the EZ-Lock Spindle Coupling and outer sleeve as clean as possible and free from debris that could become lodged inside the adapter.

#### IV.4 Temperature Control

The DV3T Rheometer provides the ability to control the temperature of a connected Brookfield temperature control device such as the Thermosel (HT-106 controller) and water baths with SD or AP controllers (for example: TC-550SD). The Thermosel or water bath can then be used to control the temperature of the sample under test.

The DV3T connects to the temperature control device through a dedicated communication cable. The Thermosel requires cable DVP-141. The water baths require cable DVP-207. These cables are available from Brookfield.

When configured for control of a temperature control device, the DV3T may have two temperature inputs:

- 1) the temperature probe supplied with the DV3T (DVP-94Y, CPA-44PYZ, or SC4-13RPY) and
- 2) the temperature probe supplied with the temperature control device (water bath or Thermosel).

Only one temperature probe can be used for display of live temperature, control, and data collection. Select the probe to be used in the Temperature menu (see Figure IV-3).



Figure IV-3

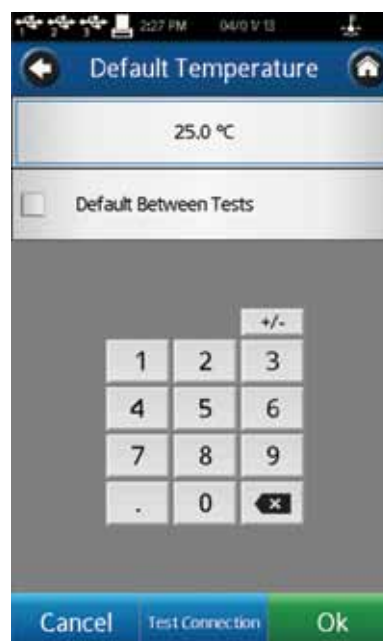

Figure IV-4

**TIP:** Embedded temperature probes used with the Cone/Plate and Small Sample Adapter can be used for set point control of a water bath. Making this selection can improve the temperature control of the sample by offsetting the temperature bath to account for any heat loss in the tubing or water jacket. To use the embedded temperature probe select Probe in the Temperature menu.

Temperature control must be initiated each time the DV3T is powered on. Be sure that the temperature control device is powered on prior to initiating communication. Choose Device Setup

in the Settings menu. Choose Temperature and you will be presented with the Temperature menu (see Figure IV-3). Temperature Offset is described in Section IV.1.

Select Temperature Controller and you will be presented with the Default Temperature menu (see Figure IV-4). This menu allows the user to 1) initiate communication with the temperature controller and 2) set a default temperature.

Initiate temperature control by pressing the Test Connection. The connection status will be confirmed with a message box.

The Default Temperature is the temperature value that the control device will return to at the conclusion of the Test. This value is set only if the check box is checked. When the check box is unchecked the temperature controller will hold at the last set point used in the Test.

**TIP:** When a test involves several temperature set points, set the Default Temperature to the first set point used in the Test. This will reduce the transition time from one Test run to the next Test run.

## IV.5 Test Parameters

The Configure Yield Test screen includes several parameters to specify the test method; Spindle, Immersion Mark, Pre-Shear Speed, Pre-Shear Time, Zero Speed, Wait Time, Run Speed, Torque Reduction, and Temperature. The required parameters are Spindle, Immersion Mark, Run Speed and Torque Reduction. All other parameters are optional including those shown below the More/Less bar; Yield Limit, Instructions, Save Path.

### Spindle

#### Spindle Number

A two (2) digit code representing the spindle number used for the test must be selected. See Appendix A for more information regarding spindles for use with the DV3T Rheometer. Selection of the appropriate spindle code is important to ensure correct stress calculations. Brookfield recommends the use of vane spindles for yield measurements.

#### Immersion Mark

Each vane spindle has two (2) immersion marks. The primary immersion mark is located on the spindle shaft. Normally, the spindle should be inserted so that the sample reaches this mark. If the sample container is too small to allow the spindle to be inserted to this mark, the secondary immersion mark may be used. This mark appears half way down the blades of the vane spindles. See Appendix D for more information regarding spindles and immersion marks.

**Note:** Selection of the appropriate immersion mark is important to ensure correct stress calculations.

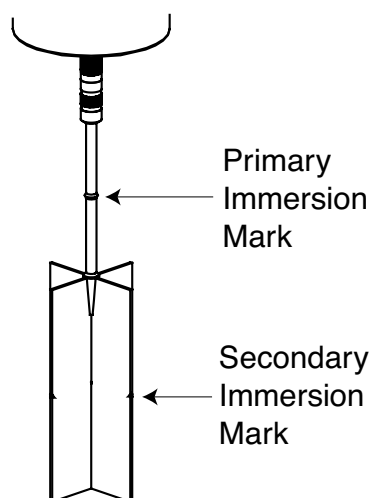

Figure IV-5

## **Pre-Shear Speed and Time**

An optional Pre-Shear step can be included in the test parameters. The user must supply the pre-shear speed (0.01 - 250 rpm) and pre-shear time (1 second - 5 minutes 59 seconds).

*Pre-shearing* is the shearing of sample before measuring its yield properties. This process breaks down the sample's structure. It is particularly useful if the investigator wants to eliminate previous shear history (e.g., bumping, transferring) of the sample before testing and observe the structural rebuilding of the sample. This may simulate the following: ketchup pumped out of a bottle will rebuild after it comes to rest on the French Fries. There are materials whose measured yield stress will be lower after pre-shearing than if tested without pre-shearing. This may be used to compare the rate at which different materials rebuild. The yield stress measured in a pre-sheared sample is the "dynamic yield", while the yield stress measured for an originally undisturbed material is the "static yield". Zeroing after pre-shearing is performed on the sample is highly recommended for every test. The next section explains how to do this.

TIP: Set Pre-Shear Speed and Pre-Shear Time to zero if no Pre-Shear is required.

## **Zero**

An optional, but highly recommended, torque Zero step can be included in the test parameters. A zero speed will cause the rheometer to rotate the motor in the appropriate direction until 0% torque is achieved.

This may be necessary because the spindle sometimes twists a small amount during insertion into the sample. This results in a small, although possibly significant, torque applied to the sample. Slow zeroing speeds are used to eliminate this initial torque and minimize effects on the sample's structure before the test is started.

Zeroing is an essential step after pre-shearing.

A zero step ensures a consistent starting point for each test. A speed for the step must be supplied in the appropriate box (0.01 - 0.50). Faster speeds achieve a "zero" quicker but may cause a more variable starting point. The DV3T will reset zero speed to 0.01 rpm when the %Torque value reaches 0.20% Torque.

## **Wait Time**

An optional Wait Time step can be included in the test parameters. Wait Time creates a time delay after zeroing before the actual test run begins. During this delay, the motor shaft will be at zero (0) RPM.

*Wait Time* is the time the sample is allowed to rest between the completion of zeroing and the start of the yield measurement. Some samples rebuild structure more slowly than others after shearing, such as during handling, pouring sample into a beaker, etc. Certain low-viscosity paints may also have a low yield stress. Waiting 30 seconds, for example, after immersing the spindle may allow the sample to rebuild, producing a more consistent test method.

## **Run Speed**

*Run Speed* is the motor speed for the DV3T at which the material is tested. It is common for materials to appear stiffer when tested at higher speeds. That is, the slope of the stress-vs.-strain curve increases with increasing speed. This is because the material structure has less time in which to react to dissipate the applied stress. Increasing the speed will, in most cases, increase the yield stress measured by the instrument. Most yield tests are conducted at relatively low speeds (<1 rpm) to minimize any inertial effects when using vane spindles. The range of acceptable run speeds is 0.01 - 5.0 RPM.

## Torque Reduction

*Torque Reduction* is percentage change in torque value between successive data points. That is, the material yields or begins to break down and, as a result, the measured incremental torque begins to decrease. A value of 100% for this parameter causes the test to stop as soon as there are no torque increases during a base time increment. Some users may wish to see a drop in torque after the yield point. Setting this parameter to values greater than 100% allows data to be collected after the yield point by the EZ-Yield™ software so the decrease in torque may be more easily visualized. However, this will also affect the calculated yield stress value.

TIP: Brookfield recommends a torque reduction value of 100%.

## Yield Limits

These stress values can be used as a Quality Control tool. If the resulting yield stress from a test falls outside these limits, an appropriate message is displayed and printed with the results. Entering zero (0) for both these parameters disables this QC feature.

## Instructions

Record specific instructions to the operator. This information will be presented immediately when the program is Run (see Figure IV-6). The operator is required to acknowledge the message before the program will continue.

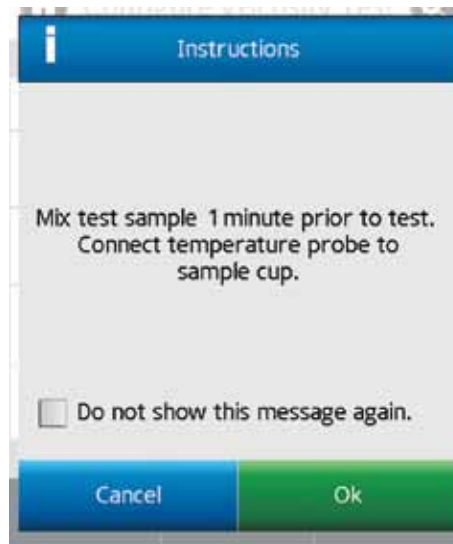

**Figure IV-6**

TIP: If the operator selects “Do not show this message again” within the Instructions message box, then Instructions will no longer be displayed for any test. This condition can be reset to allow Instructions to be displayed in the Display section of User Settings .

TIP: Instructions can be viewed during the test by selecting instructions (more/less bar) in the View Test screen.

## Save Path

Define the memory location (internal or USB Flash Drive) where the Test Results will be saved.

TIP: Selecting a data path can help to organize data storage in the internal memory of the DV3T. By preselecting the data path, operators are directed to put the data from specific tests into specific areas.

TIP: If you select a data path that includes a USB Flash Drive location and the Flash Drive has been removed, an error message will be displayed.

## IV.6 Running a Yield Test

A Yield Test is started by pressing the Run button on the Configure Yield Test screen. When Run is pressed, the display will change to the Running Yield Test screen (see Figure IV-7).

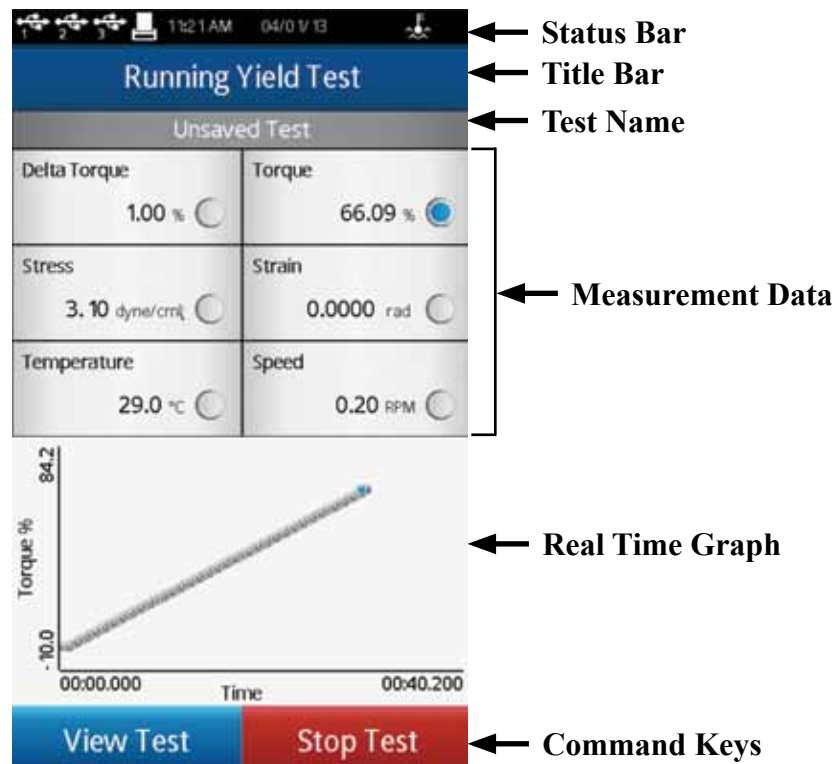

Figure IV-7

The Running Yield Test screen provides information on the current measurement including: Delta Torque, Torque, Stress, Strain, Temperature, and Speed.

**Delta Torque** is the difference between the current %Torque value and the previous %Torque value. As the sample approaches its yield point, the Delta Torque percentage should decrease. If the Torque Reduction for the test is 100%, the yield point occurs when the % decrease in Torque = 100.

**Torque** is the deflection of the Rheometer torque sensor. It is described as percent (%) and has a range of 0 – 100%. The DV3T will provide measurement results within the stated accuracy provided the Torque reading is between 10 and 100%. If the torque reading falls below 10% the labels in the data fields will flash to indicate an error condition. Brookfield does not recommend that data be collected below 10% Torque however data collection is not restricted.

TIP: Torque on the DV3T is equivalent to the % reading from the DV-III Ultra and the YR-1 Rheometer.

**Stress** is the calculated stress based on the Speed, Torque, and Spindle.

**Strain** is the Apparent Strain placed on the sample. The Apparent Strain is the angular distance that the spindle rotates in the sample.

**Temperature** is the input value from a connected Brookfield temperature probe. The DV3T is provided with a DVP-94Y probe that can be inserted into the test sample or a water bath. The Cone/Plate version of the DV3T can be utilized with a sample cup that includes an embedded temperature probe. Some Brookfield accessories include temperature probes (Thermosel) or

optional chambers with embedded temperature probes (Small Sample Adapter). The units of temperature are defined in the Global Settings section of the Settings Menu .

The temperature display will be ---- when no temperature probe is connected.

**Speed** is the selected speed from the Configure Yield Test screen.

The status of the test configuration is indicated in the grey bar above the data fields. A configuration that has been saved will be indicated by a display of the test file name. A configuration that is not saved will be indicated by a display of Unsaved Test.

The **Real Time Graph** is displayed at the bottom of the Running Yield Test. This graph shows all measurements during the life of the test. The Y-Axis can represent any data field. The data field represented on the graph is shown by the blue dot; for example, in Figure IV-7, Torque is shown on the graph. Any data field can be selected by touching the screen.

The Real Time Graph will indicate data points collected as part of the Test with a blue dot indicating the final point. At the conclusion of the test, the Real Time Graph is displayed for review. Once the OK button is pressed, the screen will transition to Results.

QC Limits will be indicated on the Real Time Graph when the selection for Y-Axis is the same as the selection for QC Limits (see Section III.9).

Two Command Keys are available on the Running Yield Test Screen: Stop Test and View Test.

Stop Test: Immediately stop the current test. The user will be presented with a confirmation box. The test will continue to run until Yes is selected in the Confirmation box. The user will be presented with the Results screen with any data that was collected.

View Test: Change the view from measurement to the test parameters. The View Test screen includes a live display of temperature. View Test includes the Stop Test command key and a Back Arrow in the Navigation Bar. The Back Arrow is used to return the display to the Running Yield Test view.







## IV.7 Results

Measurement data is viewed in the Results screen. This screen is presented at the conclusion of a test or when data is loaded through the View Results selection from the Home Menu .

The DV3T utilizes a comprehensive data format. Data files include the complete set of measurement results and calculated values along with the test protocol. All elements of the test can be viewed in the Results screen.

The DV3T Rheometer allows for 5000 total data points per file. When viewing large data files, additional time is required when moving from the various Results options listed below. There may be some delay on the screen while the DV3T prepares the data.

The results screen includes several Navigation Icons and Command Keys.

-  Home: Return to the Home Menu.
-  Down Arrow: Select Results Options.
-  Blue Arrow: Select Page of Results Table.
-  Print: Print Data to USB printer.
-  Save: Save data.
-  Configure Test: Return to Configure Viscosity Test screen.
-  Scroll Bar: Move up/down through a page of data.

The Results screen offers several options for viewing test data. These options are accessed via the Down Arrow in the Navigation Bar at the top of the screen (see Figure IV-8).

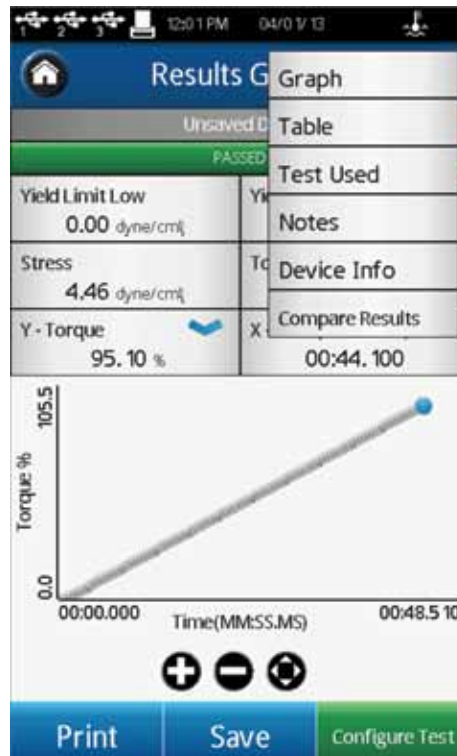

Figure IV-8

**Table:** Display all data points. Data will be shown in a scroll list where each page can hold a maximum of 50 points. If the data set has more than 50 points, then additional pages will be indicated at the bottom of the screen. Additional pages of data can be accessed through the use of the Blue Arrows

Each data point includes: Viscosity, Torque, Speed, Temperature, Time, Shear Stress (SS), Shear Rate (SR), Density, and Accuracy.

**Test Used:** Display the test elements used to generate the data set. In this view, the Configure Test button is available. Selecting Configure Test will program the DV3T to run the same test utilized to collect the data set being viewed and present the Configure Viscosity Test screen.

**Notes:** Document any relevant information about the test or data. This information will be stored with the data set once saved.

**Compare Results:** Load two data sets and view side by side (see Figure IV-9).

**Device Info:** Display basic information about the data file and the specific DV3T Rheometer used to collect the data including: date and time the test started, completed and was saved; if user accounts are active, which user saved the data; rheometer serial number, firmware version, rheometer Torque range (LV, RV, HA, HB, other).

**Graph:** Display the final data point and graph (see Figure IV-10). The graph axis (X and Y) can be changed by selecting the blue drop down arrow in the appropriate data field. Zoom and reset controls are indicated under the X-Axis.

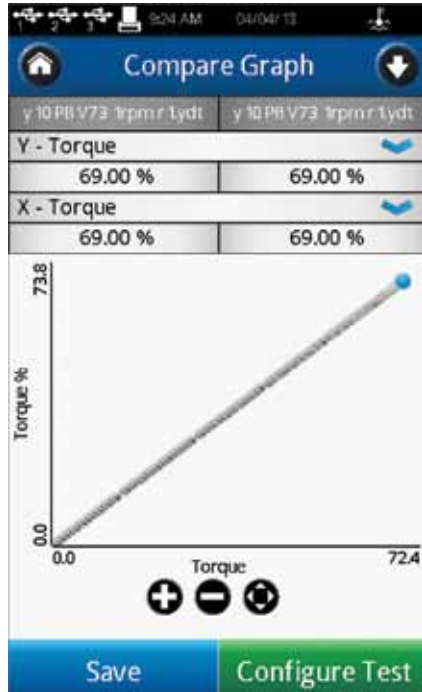

Figure IV-9

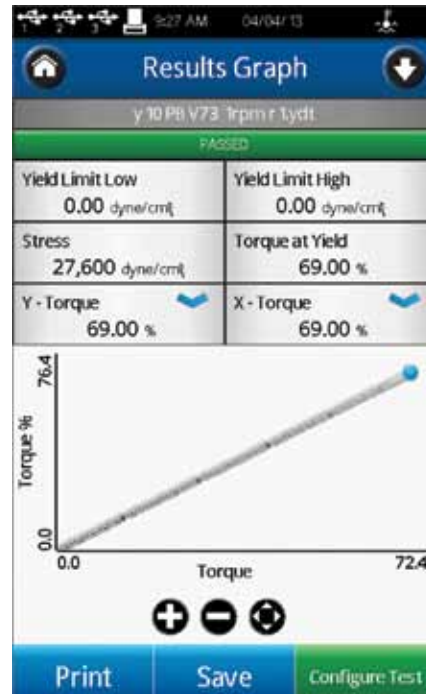

Figure IV-10



## V. SETTINGS

The Settings menu provides access to the many controls and features of the DV3T Rheometer. This menu can be accessed through the Settings Navigation Icon  which is often present in the Title Bar. Figure V-1 shows the Settings Menu which is divided into: Device Setup, User Settings, Global Settings, and Admin Functions. Global Settings include items that affect the complete range of features within the DV3T. Admin Functions include items related to administrator level controls.



Figure V-1

### V.1 Device Setup

The Device Setup menu includes settings related to the mechanical systems and connections of the DV3T. Six settings are available including:

- Temperature - Create off sets to be used with specific temperature probes, initiate control of the Brookfield Thermosel or Temperature Bath.
- Printer Setup - Define the print format to be used with the Dymo 450 Printer.
- AutoZero - Force the DV3T to perform an AutoZero as is done at start up.
- Oscillation Check - Evaluate the performance of the DV3T lower bearings.
- Technical Support Info - Information that may be requested by Brookfield Technical Support staff to assist with troubleshooting.
- About - Present basic information about the DV3T as is done at start up.

The temperature menu provides access to three functions: Temperature Offset, Temperature Controller Access, and Temperature Display/Settings.

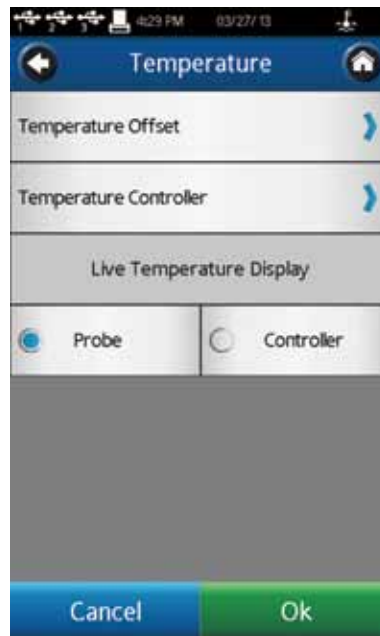

**Figure V-2**

**Temperature:** The Temperature Offset setting allows the user to create up to 10 temperature offset values for connected temperature probes. Brookfield offers several types of temperature probes for use with the DV3T including: DVP-94Y immersion probe (supplied with the DV3T), CPA-44PZY embedded probe (optional with Cone/Plate DV3T Rheometers), and SC4-13RP embedded probe (optional with Small Sample Adapter). Any of these probes can be calibrated locally against a standard reference thermometer to determine an offset (how far from the actual temperature does the probe read). This offset can be entered into the DV3T Rheometer and identified with a name defined by the user.

When Temperature is selected in the Device Setup menu, the Temperature Offset menu is presented (see Figure V-3). From this menu you can create new offset values by pressing the Add Probe Offset command key at the bottom of the screen and you can select which offset to utilize with the DV3T by pressing the circle beside the name. In Figure IV-3, the offset DVP-94Y 3 has been selected as indicated by the blue circle.

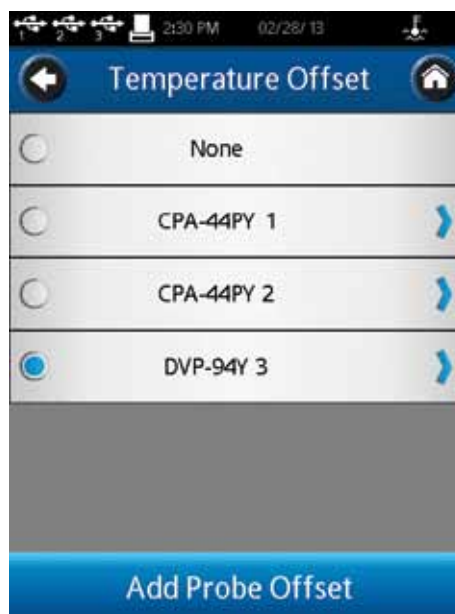

**Figure V-3**

The creation of a Temperature Offset requires input of the offset value and a name. The offset value must be in the range of -9.9 to 9.9°C. The Name can be up to 14 characters long. To delete an existing Temperature Offset, first select the offset from the list, then press the Delete command key at the bottom of the screen.

The use of a Temperature Offset will be indicated in the Temperature field displayed in the Configure Viscosity Test screen with a (o) beside the Live indication.

The Temperature menu also allows the user to initiate control over a connected temperature control device such as the Brookfield Thermosel (HT-106 controller) or Water Bath (model TC-XX0SD or TC-XX0AP). See Section II.4 for further details. Establish control over the external temperature controller by selecting Temperature Controller in the Temperature menu (see Figure V-4).



**Figure V-4**

Communication is established when the Test Connection command button is pressed. You must press this button every time the DV3T Rheometer is powered on. Be sure that the temperature controller is turned on prior to pressing the Test Connection button.

The Default Temperature screen also allows the user to set a Default Temperature. The Default Temperature is the set point value that will be used by the DV3T when a test (Viscosity Test or Yield Test) is not in use. To set the Default Temperature first, enter a temperature value and second check the Default Between Tests check box.

**TIP:** Use a Default Temperature when the test program includes a change in temperature and set the value equal to the first temperature control point in the test. At the conclusion of the test, the control device will be reset to the first temperature set point which will minimize the time required between tests.

The Temperature screen also allows you to choose which temperature probe will be used for data collection and temperature control. When the DV3T is controlling temperature through an external device, there may be two temperature probes available for data collection: 1) the temperature probe connected to the DV3T (Probe) and 2) the temperature probe associated with the temperature control device (Controller). Press either Probe or Controller in the Temperature menu, figure the first one above.

**Printer Setup:** The DV3T is configured for use with the Dymo 450 printer. No other printers can be utilized with the rheometer. Printer Setup allows the user to choose from three different configurations for print out.

Label Small: A small label (1.13inch x 3.5inch) that allows for printing of limited data for a single data point. The label stock is available from Brookfield; part number GV-1048.

Label Large: A large label (2.31inch x 4.0inch) that allows for printing of a complete set of parameters for a single data point. The label stock is available from Brookfield; part number GV-1049.

Receipt: A continuous roll of paper that allows for printing of multiple data points. The paper stock is available from Brookfield; part number GV-1047.

The Printer Setup is selected by touching the desired configuration, which will result in a blue circle to appear to the left of the item. The OK command key must be selected to confirm the setting.

**AutoZero:** AutoZero is an operation performed by the DV3T Rheometer automatically during the power up sequence. This operation sets the instrument transducer to a correct zero value. The zero value should not shift over time, however, if the user determines that the zero is not correct, you can force an AutoZero to be performed without powering down the rheometer. When the AutoZero function is selected, the DV3T is immediately sets to AutoZero mode and the user is presented with the AutoZero screen (Figure II-2). Upon completion, the user will be returned to the Device Setup menu.

**Oscillation Check:** The Oscillation Check is a check of the performance of the lower bearing of the DV3T Rheometer. This lower bearing is either Point and Jewel or Ball Bearing. Correct performance of the lower bearing is essential for proper operation of the rheometer. A failed lower bearing will normally cause viscosity measurements to be lower than expected.

An Oscillation Check is performed as follows:

- Remove the spindle and level the DV3T Rheometer
- Gently push up on the rheometer coupling.
- Turn the coupling until the % Torque reading is 10 – 15 %.
- Gently let go of the coupling.
- Watch the reading. The % Torque reading should decrease smoothly and oscillate about 0.0%.

Selecting Oscillation Check in the Device Setup menu will present the user first with a screen instructing to level the rheometer and remove the spindle. Confirmation of level and spindle removal will present the user with the Oscillation Check screen as shown below.

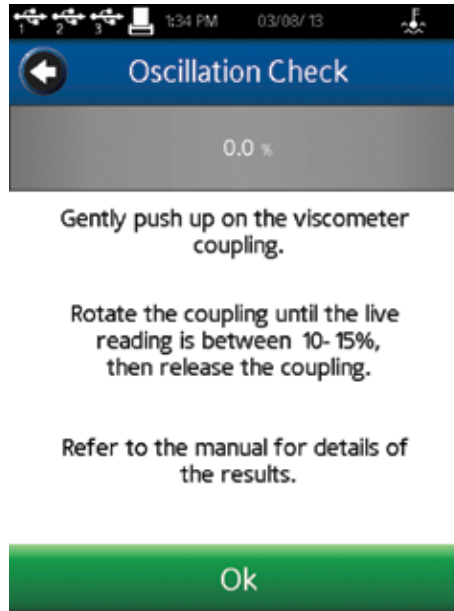

**Figure V-5**

A successful Oscillation Check will show a very smooth decrease of %Torque with a final value within +/-0.2 of 0.0. Any value above 0.2 % or below -0.2% indicates that a calibration check should be performed (see Appendix F).

**TIP:** Higher Torque ranges (HA and HB) will quickly return to the zero value without displaying much oscillation. This is normal behavior.

The Oscillation Check is not a guarantee of proper calibration. It is only an indication of the performance of the lower bearing of the rheometer. Calibration can only be verified through the use of a calibration standard such as Brookfield Silicone and Mineral Oil standards.

**Technical Support Info:** The information contained in the Technical Support Info menu is designed to support Brookfield for problem resolution. When contacting Brookfield for support, you may be asked to provide information contained in one of the menu choices within Technical Support Info. There are no settings within this section and the performance of the DV3T Rheometer can not be affected by accessing this section.

**About:** The About screen is shown during the start up sequence of the DV3T Rheometer. Selecting About in the Device Setup menu will show the same information (see Figure V-6). Information

in the About screen includes: Torque Range (LV, RV, HA, HB), Model Number, Firmware Version, Rheometer Serial Number, TK version (torque table), Spindle version (spindle table).

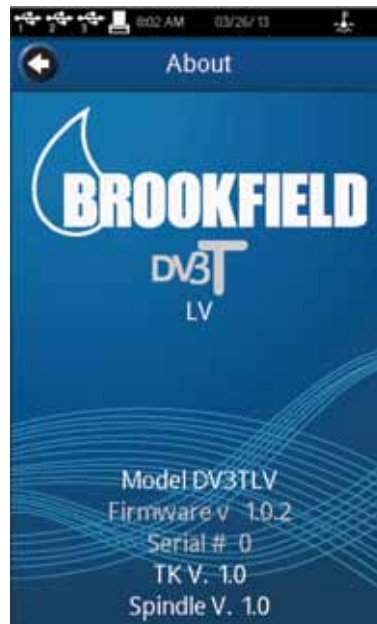

**Figure V-6**

**TIP:** The information on the About screen will be needed when contacting Brookfield for support.

To return from the About screen, press the Left Arrow navigation button in the Title Bar.

## V.2 User Settings

The User Settings menu includes settings related to specific users. The DV3T may be set up for a single user setting (used by one or more operators) or for multiple users who access through a Log In and Password.

Three User settings are available including:

- Sound - Adjust the volume of the DV3T sounds and select which sounds to silence.
- Display - Adjust the brightness, select language and restore Pop-Up messages.
- Change Password - Change the password for the Log In account used to access the DV3T Rheometer.

**TIP:** Each User can set their own preferences for Sound and Display.

**Sound:** The Sound menu provides adjustment of the volume for the sounds utilized by the DV3T. Additionally, specific sounds can be toggled on/off including: Button Click, Test End Alarm, QC Limits Alarm, Global Alarm, and Pop-Up.

**TIP:** Sound settings can be returned to Factory Setting through Settings Reset found in the Admin Function Settings menu.

**Display:** The Display menu provides adjustment of Screen Brightness, Language Selection, and Pop-Up Message management. The Screen Brightness adjustment applies to all screen views within the DV3T.

Note: The screen brightness is dimmed automatically after 5 minutes of no touch screen activity. The brightness will be dimmed to the lowest value. A single touch of the touch screen will return the display to the set brightness value.

The Language Setting is selected by pressing the Language field and choosing the appropriate language from the list. The selected language will be implemented immediately.

Pop-Up Messages can be toggled on/off through the check box (see Figure V-7). This check box applies to all Pop-Up Messages. Pop-Up Messages can be toggled off individually through the check box that appears within the message box. Once the Pop-Up is turned off, it will not be shown again. Pop-Up Messages can be restored through the use of the Restore Hidden Pop-Ups command key at the bottom of the Display Settings screen. This command key will restore all Pop-Ups.

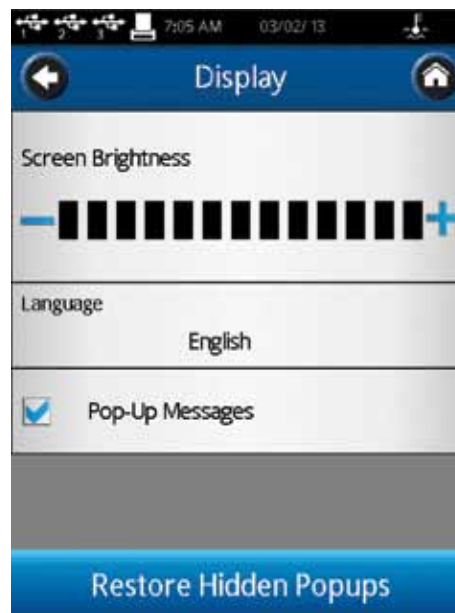

**Figure V-7**

**Change Password:** A specific user can change their own password at any time. The user must first enter the current password. Then the user will be prompted to enter and confirm the new password.

TIP: If the administrator password is lost, it can be reset. Please contact Brookfield or your Brookfield representative. Remember to have the information found in the About screen available (see Section V.1).

## V.3 Global Settings

The Global Settings menu includes settings that affect the operation of the DV3T across all users and menus. These settings are independent of user log in. The five Global Settings include:

- Measurement Units - Select the unit of measure for several parameters.
- Regional Settings - Specify language, number, time, and date formats.
- Global Alarm - Select a single measurement parameter for alarm status.
- Spindle List - Configure the display of available spindles; create a special spindle.
- Speed List - Configure the display of available speeds; create a new speed.

**Measurement Units:** The Measurement Units menu displays the current selections for measurement units. Each unit can be changed by pressing the blue down arrow and selecting the desired value. Measurement Units are part of the data file for saved results. Available units include:

Viscosity	cP	centipoise
	P	Poise
	mPa•s	milliPascal seconds
	Pa•s	Pascal seconds
	cSt	centistokes
	mm <sup>2</sup> /s	millimeters squared per second
	1000 cP = 10 P = 1000 mPa•s = 1 Pa•s 1 cSt = 1 mm <sup>2</sup> /s	

**TIP:** When cSt units are chosen for viscosity, a density value must be entered in the Density field in Configure Viscosity Test.

Speed	RPM	revolutions per minute
	1/s	reciprocal seconds

The relationship between RPM and 1/s is defined by the SCR value of the selected spindle. See Appendix D for details.

Temperature	C	Centigrade
	F	Fahrenheit
	100 C = 5/9 * (212 F – 32)	

Stress (Shear)	Dyne/cm <sup>2</sup>	Dyne per square centimeter
	N/m <sup>2</sup>	Newton / square meter
	Pa	Pascal
	10 dyne/cm <sup>2</sup> = 1 N/m <sup>2</sup> = 1 Pa	



Density	g/cm <sup>3</sup>	gram / cubic centimeter
	kg/m <sup>3</sup>	kilogram / cubic meter
	1 g/cm <sup>3</sup> = 1000 kg/m <sup>3</sup>	

TIP: Density and viscosity are both sensitive to temperature. When using a density value in Configure Viscosity Test, be sure to enter a density value that was determined at the same temperature as that of the viscosity measurement.

**Regional Settings:** The Regional Settings menu displays the current selections for the default language, number format, date format and day separator. Each setting can be changed by pressing the blue down arrow and selecting the desired value. Regional Settings are part of the data file for saved results.

The Language setting established the default language for the DV3T. Individual users can choose a different language for use with their specific log in (see Section V.2).

The formats for Number, Time, Day Separator and Date offer several options.

Number Format	9,999,999.00	USA decimal convention
	9.999.999,00	Europe comma convention
	9 999 999,00	SI/ISO space convention
Time Format	13:59:59	24 Hour Format
	1:59:59 PM	12 Hour Format
Day Separator	/	Forward Slash
	-	Dash
	.	Period
Date Format	Year/Month/Day	ISO Standard
	Month/Day/Year	USA Standard
	Day/Month/Year	International Standard

**Global Alarm:** The Global Alarm establishes a single measurement parameter with a range of acceptance. Whenever the measured value exceeds this range of acceptance, an audible and visual alarm will be issued. The Global Alarm will apply to any test that is run. The QC Limit also establishes a measurement parameter with a range of acceptance; however, the QC Limit is applied only to the test in which it is defined.

The Global Alarm can be set for any of the four measurement parameters including; Shear Stress, Temperature, Torque and Viscosity. Once a parameter is selected, both low and high limits must be entered. These limits are independent of the spindle and speed selected. When the global alarm is triggered, the DV3T will provide an audible alarm and a Warning message on the screen (see Figure V-8). The error message will provide some detail about the alarm condition. The test

and data collection will continue while the Warning message is displayed. The audible alarm will continue to sound until the operator touches the OK button within the Warning box.

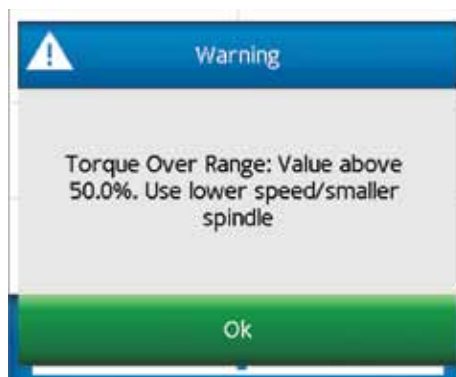

**Figure V-8**

The Running Viscosity Test display will show a colored box around the data parameter associated with the Global Alarm. When the alarm condition is first met, the colored box will be yellow. If the measurement parameter returns to the acceptable range, then the colored box will be removed. When the alarm condition is met a second time, the colored box will be red (see Figure V-9). The audible alarm will only sound once.



**Figure V-9**

**TIP:** The Global Alarm sound can be turned off in the Sounds menu of User Settings.

The Global Alarm is deactivated by choosing None in the drop down list of available measurement parameters. You must press OK to confirm your Global Alarm choice.

**Spindle List:** The selection of Spindle in Configure Viscosity Test can be done by using either a number pad or a scroll list. (This choice is selected through the navigation button in the Set Spindle screen.) The contents of the scroll list are defined in the Spindle List menu. Each spindle can be individually selected or deselected through the use of a check box. Spindles, shown with both their name and their number, are listed numerically according to their spindle entry number.

The restricted spindle will not appear on the scroll list of available spindles when choosing Spindle in Configure Viscosity Test. If the user selects to enter the spindle by number, then the choice of a restricted spindle will present an Invalid Input message and prevent the selection of the spindle (see Figure V-10).

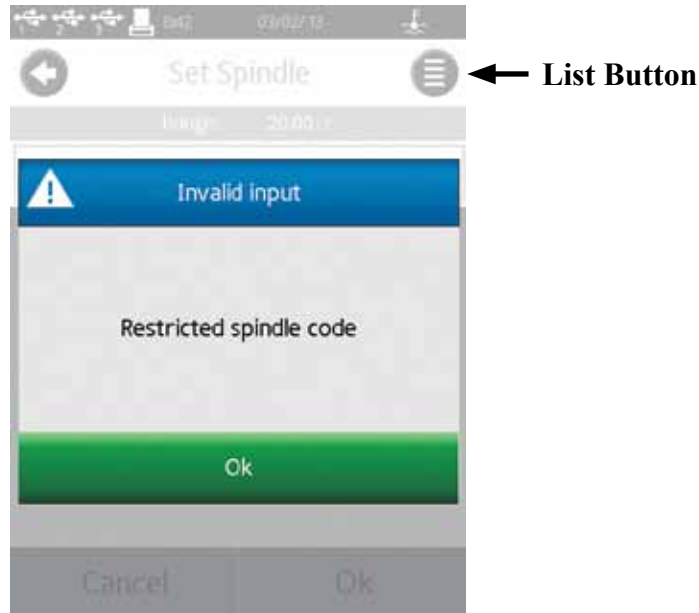

**Figure V-10**

**TIP:** To ensure that the correct spindle code is always entered, create a test that is saved to the DV3T memory.

**TIP:** The selection of spindle can be restricted by User Log In. Use this restriction combined with a saved test configuration to ensure that the correct spindle is always used for critical tests. See Section V.4.2 for details of Users and Access.

A Special Spindle can be created when the user has developed a new spindle geometry or when using a standard Brookfield spindle in a non standard measurement container. The Special Spindle, once created, will be available to users through the Spindle selection in Configure Viscosity Test.

A Special Spindle is created by selecting the Special Spindle command button in the Edit Spindle List menu. A Special Spindle requires a code, a name, and an SMC value. Optional values include SRC and YMC.

Code	The code is the numerical value used to select the spindle. This value must be unique and can not be the same as a standard Brookfield spindle. The acceptable range for Code is 100-199.
Name	The Name is a unique value to describe the spindle. The Name will be displayed in the Spindle field. The Name can be comprised of alpha and numeric characters.
SMC	<p>The SMC (Spindle Multiplier Constant) is used to convert the measured torque to viscosity. The acceptable range of SMC is 0.001 – 500.</p> <p>The SMC value can be determined through the use of the Range equation found in appendix D. Some experimentation with the spindle and a calibrated viscosity standard is required.</p> <p>Range (cP) = TK * SMC * 10,000/RPM</p> <p>The Torque Constant (TK) can be found in Table D-2 in Appendix D.</p>
SRC	<p>The SRC (Shear Rate Constant) is used to convert the set RPM to shear rate and calculate Shear Stress. The acceptable range of SRC is 0.001 – 500.</p> <p>The SRC value can be determined if the shear rate characteristics of the spindle geometry are known. Consult the Brookfield publication, “More Solutions to Sticky Problems”, for a discussion about shear rate and some recommended equations.</p> <p>Shear Rate (1/s) = SRC * RPM</p>
YMC	The YMC (Yield Multiplier Constant) is used to convert the measured torque to yield stress.

**Speed List:** The selection of Speed in Configure Viscosity Test can be done by using either a number pad or a scroll list. (This choice is selected through the navigation button in the Set Spindle screen.) When scroll list is selected, the speed entry is restricted to the classic Brookfield speed sets for the LV and RV/HA/HB rheometers. The contents of the scroll list are defined in the Speed List menu. Each speed can be individually selected or deselected through the use of a check box. Select or deselect all speeds by using the Select All check box. Select or deselect all LV (or RV/HA/HB) speeds by using the Select All LV check box. The classic Brookfield speed sets are defined below.

LV:	0.3, 0.6, 1.5, 3, 6, 12, 30, 60
RV/HA/HB:	0.5, 1.0, 2.0, 2.5, 4, 5, 10, 20, 50, 100

Additionally, a new speed can be added to the list by selecting the New Speed command key at the bottom of the display. The New Speed must be selected within the range of available speeds on the DV3T: 0.0 – 250 RPM.

Speed entry through the number pad is never restricted.

TIP: To ensure that the correct speed is always entered, create a test that is saved to the DV3T memory.

TIP: The selection of speed can be restricted by User Log In. Use this restriction combined with a saved test configuration to ensure that the correct speed is always used for critical tests. See Section V.4.2 for details of Users and Access.

## V.4 Admin Functions

The Admin Functions menu includes settings related to access and basic instrument management of the DV3T. The Admin Functions menu is only available to the Administrator when Log In is required. Users and Power Users do not have access rights to the Admin Functions. Nine settings are available including:

- |                      |                                                                                    |
|----------------------|------------------------------------------------------------------------------------|
| Log In and Lock Out  | - Require User ID and Password. Define Lock Out parameters.                        |
| Users and Access     | - Define User ID, Password, User capabilities. Add User.                           |
| Set Time and Date    | - Set the time and date.                                                           |
| Backup and Import    | - Update Instrument Firmware, add Language file, Back Up data and settings.        |
| Default Path         | - Define the logic for the Default Path for saving data and tests.                 |
| Settings Reset       | - Reset basic settings to DV3T factory default.                                    |
| Device Reset         | - Reset the entire DV3T to factory default.                                        |
| Calibration Reminder | - Establish use and frequency of calibration reminder.                             |
| Save Audit Trail     | - Export the Audit trail to assist Brookfield when troubleshooting DV3T operation. |

### V.4.1 Log In and Lock Out

The Log In and Lock Out menu allows the user to define the Log In requirement and toggle the Lock Out feature within Running Viscosity Test (see Figure V-11).



Figure V-11

The Log In check box controls the Log In requirement. When Log In is checked, the DV3T will require a User ID and Password prior to allowing any activity. The Log In screen is presented on power up or when the User Icon  is selected from the Home Menu. The user must select their User ID from the drop down list and then enter their password. The Log In requirement is removed when the check box is unchecked.

NOTE: Administrator default password is admin.

The Allow Lock Out check box controls the Running Viscosity Test Lock Out function. This function is only available when User Login is required. When Allow Lock Out is checked, the user may lock the DV3T during a test. The Lock Out is set by pressing the Lock Icon  found in the Navigation Bar of Running Viscosity Test. Any touch of the screen during the Lock Out will show the user a Log In screen. No action can be taken on the DV3T until the proper password is entered. Only the User ID that was in effect when the Lock Out was initiated can unlock the DV3T. The test will continue to collect data during the Lock Out.

The Allow Timed Lock Out check box controls the automatic feature of Lock Out. Set the Timed Lock Out time value from 1 – 99 minutes. The DV3T will Lock automatically (without touching the Lock Icon) after the test is initiated (press Run) when the screen has not been touched for the time specified. For example: Timed Lock Out is set to 1 minute; 30 seconds after the test has begun, the operator reviews the test parameters by touching Views Test; the DV3T will lock automatically 1 minute after that key press (90 seconds after the test began running).

TIP: The Lock Out feature can be useful if the operator must leave the DV3T unattended during a test.

The Lock Out After parameter defines how many failed Log In attempts are allowed before the User ID is locked. The range for Lock Out After is 1 – 20. Once a User ID is locked, the administrator must reset the password.

TIP: If Require Login checked default Administrator password is “admin”, the administrator should change the default password prior to placing the instrument into service (see Section IV.2 for instructions on changing passwords).

## V.4.2 Users and Access

The DV3T can be set up with User accounts to restrict access and enhance data tracking. Two user levels are available within the DV3T and each can be customized by the Administrator. All user accounts require a password for access to the DV3T.

The User Settings are divided into four categories: General Settings, Data Access Functions, Viscosity Test Setup and Yield Test Setup. Table V-1 shows the factory default user settings for Power User and User. The administrator can customize both the Power User and User through the Power User Level Access and User Level Access in the Users and Access Menu. Place a check mark beside an attribute that is available to the user and remove the check mark from an attribute that will be unavailable to the user.

TIP: Users and User Access settings can be exported to a Flash USB drive. This file can be uploaded to another DV3T or DV3T to quickly duplicate User settings.

The User ID utilized at Log In will be reflected in a saved data set. This parameter is viewable in the Results screen by selecting Device Info.

TIP: The User ID information is only visible once a data set is loaded from memory. An unsaved data set will not show the User ID.

User accounts can be managed within the Users and Access menu through Edit Users, Add User and Delete User.

**Table V-1: Factory Default User Settings**  
(continued on following page)

			Administrator	Power User	User
General Settings	Set	Default Temperature Set Point	N/A	N/A	N/A
		Temperature Probe Offset	•	•	
	Allow	Test Done Alarm	•	•	•
		QC Alarm	•	•	•
		Global Alarm	•	•	•
		Pop-Up Warnings	•	•	•
		Dismiss Pop-Up Warnings	•	•	
		Customize			
		Spindle List	•	•	
		Speed List	•	•	
		Regional Settings	•	•	•
		Measurement Units	•	•	•
		Language	•	•	•
Data Access Functions	Load A Test	Instrument	•	•	•
		USB	•	•	
	Save a Test	Instrument	•	•	•
		USB	•	•	
	Load Data	Instrument	•	•	•
		USB	•	•	
	Save Data	Instrument	•	•	•
		USB	•	•	
	Other Options	Delete Test & Data	•	•	
		Move Test & Data	•	•	
		Copy Test & Data	•	•	
		Rename Test & Data	•	•	
		Overwrite Test & Data	•	•	
		Print Data	•	•	•
	Viscosity Test Setup		Change Speed During a Test	•	•
Set		Spindle	•	•	
		Speed	•	•	
		Temperature Setpoint	•	•	
		Step End Condition	•	•	
		Data Collection Mode	•	•	
		QC Limits	•	•	
		Density	•	•	
		Graph Axes	•	•	
		Math Model	•	•	
		Default Results Screen	•	•	
		Post Test Averaging	•	•	
		Instructions	•	•	
		Save Path	•	•	

		Administrator	Power User	User	
Yield Test Setup	Set	Spindle	•	•	
		Immersion Mark	•	•	
		Pre-Shear Speed	•	•	
		Pre-Shear Time	•	•	
		Wait Time	•	•	
		Run Speed	•	•	
		Zero Speed	•	•	
		Torque Reduction	•	•	
		Yield Limits	•	•	
		Temperature Setpoint	•	•	
		Graph Axes	•	•	
		Instructions	•	•	
		Save Path	•	•	

**Table V-1: Factory Default User Settings**  
(continued from previous page)

### V.4.3 Set Time and Date

The Time and Date is displayed on the Status Bar at the top of every screen. These parameters are set within the Set Time and Date menu. The format for setting Time and Date will be based on the Regional Settings (see Section V.3). Change from Set Time to Set Date by pressing the command key at the bottom of the screen. When both Date and Time are set correctly for your location, press OK to accept the change.

### V.4.4 Backup and Import

The DV3T Rheometer provides several options relating to storage of Results, Tests and User Settings. Backup and Import menu options relate to creating back up files, updating instrument software, and updating language files.

**Backup:** Create a backup file from the DV3T internal memory including: Settings, User Profiles, Results, and Tests. This backup file is saved to a USB Flash Drive and can be uploaded (Restore) to any DV3T Rheometer.

Choose the location within a USB Flash Drive where the Backup file is to be saved. A new folder can be created by using the New Folder button. Press the Backup button to create the Backup file.

**Restore:** Upload a previously saved Backup file. The information from the Backup file includes: Settings, User Profiles, Results, and Tests. Existing User profiles will not be overwritten. User profiles from the Backup file will be added to the user profiles that already exist on the DV3T.

Locate the Backup file on the attached USB Flash Drive. Press the Restore button to upload the Backup file.

**Automatic Backup:** Create Backup files according to a schedule. The frequency is set to Daily, Weekly or Monthly increments. The Path must be specified and requires the use of a USB Flash Drive. Check the Allow Automatic Backup check box to initiate this feature. The current Backup file will overwrite the previous Backup file located in the path location.

TIP: You can preserve historical backup files by using multiple USB Flash Drives.

**Import:** Upload Settings from a Backup file. User profiles, Results and Tests are not included.

Locate the Backup file on the USB Flash Drive. Press the Import button to upload Settings from the Backup file.



**Add Language:** Language files can be added to the DV3T as they become available from Brookfield. Insert a USB Flash Drive into the DV3T that contains the language file. Select Add Language from the Backup and Import menu and select the appropriate path. Press the Import command button to bring the new language file into the DV3T. Select the language in the Display section of the User Settings menu.

**Update Software:** The internal operating software of the Brookfield DV3T can be updated from a USB Flash Drive as new versions become available from Brookfield. Insert a USB Flash Drive into the DV3T that contains the operating software file. Select Update Software from the Backup and Import menu and select the appropriate path. Press the Update command button to bring the new software file into the DV3T.

#### V.4.5 Default Path

The Path is the location where data or tests are stored. The DV3T will allow for storage to the Internal Memory or to an attached USB Flash drive. The path will also include any file structure that has been created.

The Default Path identifies what location will be used as the initial location when Results are saved. The Default Path defined in Reports - Configure Viscosity Test (saved test or unsaved test) will take priority over the Default Path.

The DV3T can create file structure based on User ID and Test Name. The options provided for the Default Path specify what format the data path should utilize. For example: set the Default Path to Operator -> Test Name. The User is logged in as DAVID and the test to run is INK 5. The data path will be defaulted as shown in Figure V-12.



**Figure V-12**

**TIP:** The Default Path can be overwritten at the time that data is saved.

Note that there is a limitation of 99 Results files which can exist in a single Path location. If this limit is exceeded, specify a different data Path to save new files to, or remove files from the Path location to decrease the number below 99. This limitation applies to all data Paths created on either the USB Flash Drive or Internal Memory.

## V.4.6 Settings Reset

Settings Reset will return the DV3T settings (Device, User and Global) to the factory default. Internal memory will not be affected. User accounts will not be affected.

## V.4.7 Device Reset

 **DATA LOSS POSSIBLE!**

Device Reset will return the DV3T to the factory default condition. All data, tests and Audit Trails will be deleted from internal memory. All User accounts will be deleted.

TIP: Move data files and test files to a USB Flash Drive prior to selecting Device Reset.

## V.4.8 Calibration Reminder

The DV3T can be programmed to provide the user with a reminder that calibration is due. Two parameters must be set: Frequency in Months and Start Date. When both parameters are entered, the Calibration Reminder screen (see Figure V-13) will calculate and display the day when the reminder will be presented.

Check the Calibration Reminder On check box to activate this feature.



Figure V-13

The Calibration Reminder will be presented during the first power up on or after the specified day. The message box (see Figure V-14) requires that the user press OK before the AutoZero will be performed.

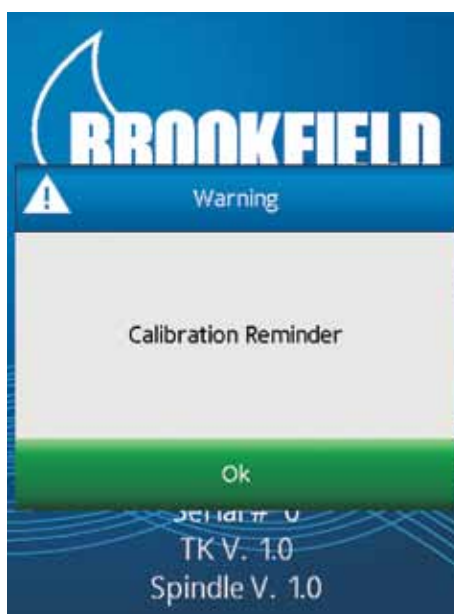

**Figure IV-14**

The calibration reminder will be reset by Brookfield or your authorized Brookfield dealer when the unit is returned for calibration.

#### **V.4.9 Save Audit Trail**

The Audit Trail is a collection of instrument check values that can assist Brookfield with troubleshooting activities. You may be asked to provide the Audit Trail files. Use Save Audit Trail to create an Audit Trail file on a USB stick. Two files will be created: Users.bin and Service.bin.

## VI. PG FLASH SOFTWARE

Viscosity Test programs for the DV3T can be created on a computer through the use of PG Flash software. PG Flash is provided with all DV3T Rheometers on a CD that contains several different Brookfield utility software programs. PG Flash is designed to operate on the Windows platform XP or higher.

PG Flash software provides all Viscosity Test controls that are available on the DV3T. Additionally, multiple step Viscosity Test programs can be created for use on DV3T. Tests that are created and saved on the computer can be loaded onto a USB Flash Drive and then loaded into the DV3T through the Load Test function .

PG Flash offers:

- Convenient Viscosity Test creation through a PC interface
- Convenient Yield Test creation through a PC interface.
- Storage of Tests on a PC or USB Flash Drive
- Creation of single step Viscosity Tests
- Creation of multiple step Viscosity Tests

Windows Requirements for PG Flash:

- Windows™ 2000 or above
- 500 MHz processor
- 256 MB RAM
- USB Port
- 1280x768 resolution display

The PG Flash interface is shown in Figure VI-1. This screen is divided into four areas: Instrument Bar, General Parameters, Test Parameters, and the Program Grid.



Figure VI-1

The Instrument Bar includes the setting for DV3T or DV2T. PG Flash can be used to create programs for both the DV3T and DV2T. The DV3T has additional control parameters which are not available on DV2T. PG Flash should be set to DV3T when creating programs for the DV3T. When set to DV3T, the yield test tab becomes available. The Instrument Bar also includes the Load Test key and Reset Key. Load Test allows the user to load tests that have previously been saved to the PC or a Flash USB Flash Drive. Reset All clears all data within the PG Flash interface including: General Parameters, Test Parameters, and the Program Grid.

The **General Parameters** section includes all Viscosity Test program controls that will apply to every step of the program.

Spindle:	The spindle to be used with this Viscosity Test. All calculations will be based on this spindle number.
Report Screen:	Select the view to be presented upon the conclusion of the Viscosity Test.
Save Results Path:	Select if a path for saving data is to be defined. Define the save path.
Post Test Averaging:	Select the type of averaging to perform at the end of the test.
Instructions:	Document the instructions to present to the operator when the test is run.

The **Test Parameters** section includes all Viscosity Test program controls that may vary if there is more than one test step.

Speed:	Speed of rotation of the spindle.
Data Collection:	Data Collection method.
Time Interval:	Time interval used for Data Collection methods that include averaging.
Density:	Density value to be used if kinematic viscosity units are selected (cSt, mm <sup>2</sup> /s).
End Condition:	Condition which sets the end of the Viscosity Test.
End Condition Value:	Parameter based on chosen End Condition.
QC Limits:	Parameter to be used for QC limit indicators.
QC High / QC Low Limit	Parameter based on the chosen QC Limits.
Collect Single Point at Step End:	During a Multi Point data collection, force the DV2T to collect a data point at the end of the step (when the End Condition is achieved).
Include This Step into Average Calculation:	Data from this step will be included in the average calculation indicated by the selection in Post Test Averaging.
Add, Insert, Delete Step Buttons	
Save Button	

The **Program Grid** shows all Test Parameters for each step in a line view.

All measurement units can be set through the Units Setup button (see Figure VI-2). This menu can be pinned to the screen. If the menu is not pinned, then it will minimize when the mouse is moved outside of the window.



Figure VI-2

Sample Viscosity Test programs can be seen in the following figures. Figure VI-3 demonstrates a typical single step test. Figure VI-4 demonstrates a multiple step test.



Figure VI-3

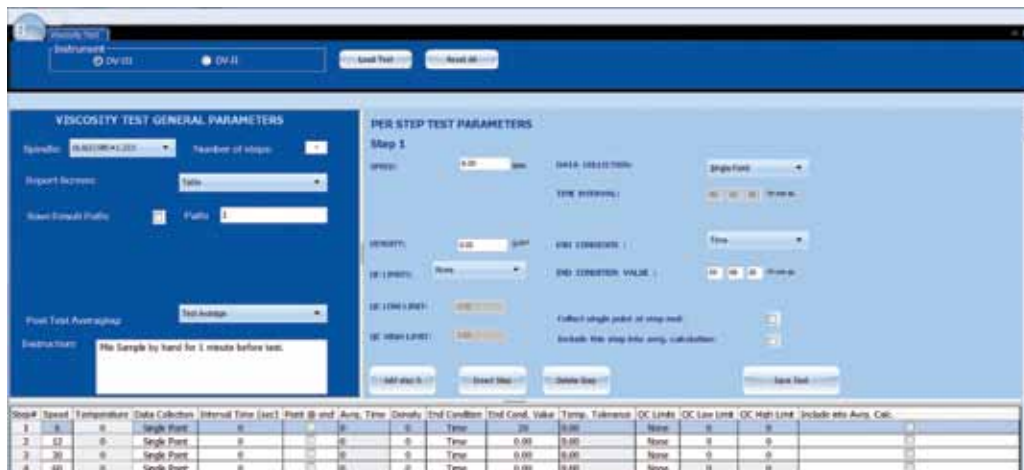

Figure VI-4

Yield Test parameters are shown in a single area within PG Flash without a Program Grid (only a single step for Yield Tests). All yield parameters are available including Spindle Settings, Test Settings and Test Instructions & Path Settings.

- Spindle: The currently selected spindle. All Yield and Stress calculations will be made based on the Spindle selection and the Immersion Mark. Spindle choice is limited to vane spindles or user defined custom spindles.
- Immersion Mark: Specify the immersion location of the Brookfield vane spindle. Primary is at the immersion mark shown on the spindle shaft. Secondary is at the mid-point of the vane surface.
- Pre-Shear Speed: Specify a speed of rotation for pre-shear of the sample
- Pre-Shear Time: Specify the duration of the Pre-Shear step.
- Zero Speed: Specify the speed of rotation used to return the %Torque reading to zero before starting the yield measurement.
- Wait Time: Specify the duration of a rest period prior to starting the yield test.
- Test Run Speed: Specify the speed of the yield test.
- Torque Reduction: Specify the end point of the test. Normally set to 100%.
- Temperature Set Point: Alive signal from the rheometer when a temperature probe is attached (Brookfield Part No. DVP-94Y). Also shown is the set point used to control the attached temperature controller (Brookfield Thermosel or TC-XX0SD / TC-XX0AP Temperature Baths).
- Yield Low Limit: Parameter based on the chosen QC Limits.
- Yield High Limit: Parameter based on the chosen QC Limits.
- Save Results Path: Define the memory location where the data will be saved.
- Instructions: Create a message that the user will see when the test begins.

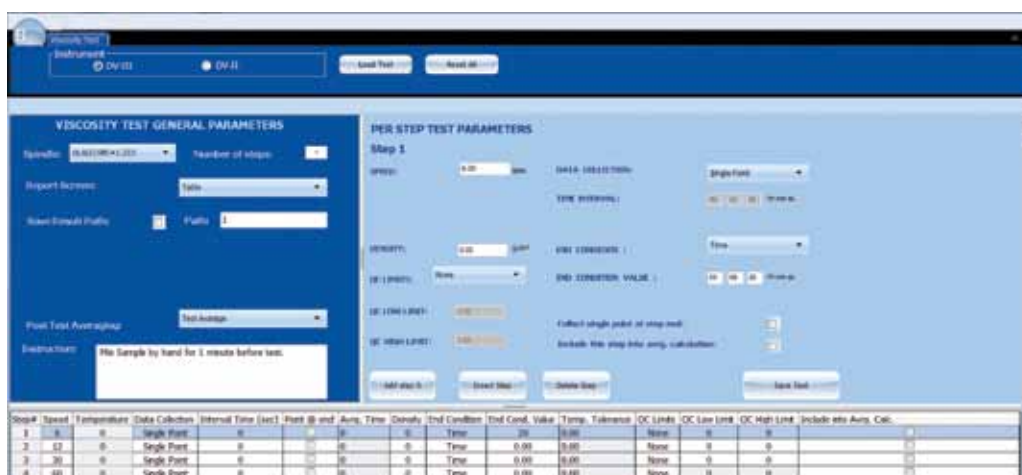

Figure VI-5

## VII. MATH MODELS

### VII.1 The Power Law (Ostwald) Model

$$\tau = k\dot{\gamma}^n \quad (\tau = \text{shear stress, } k = \text{consistency index, } \dot{\gamma} = \text{shear rate, and } n = \text{flow index})$$

#### What does it tell you?

The Power Law model provides a consistency index,  $k$ , which is a product's viscosity at one reciprocal second. (Reciprocal seconds are the units of measurement for shear rate.) It also provides a flow index,  $n$ , which indicates the degree with which a material exhibits non-Newtonian flow behavior. Since Newtonian materials have linear shear stress vs. shear rate behavior and  $n$  describes the degree of non-Newtonian flow, the flow index essentially indicates how “non-linear” a material is.

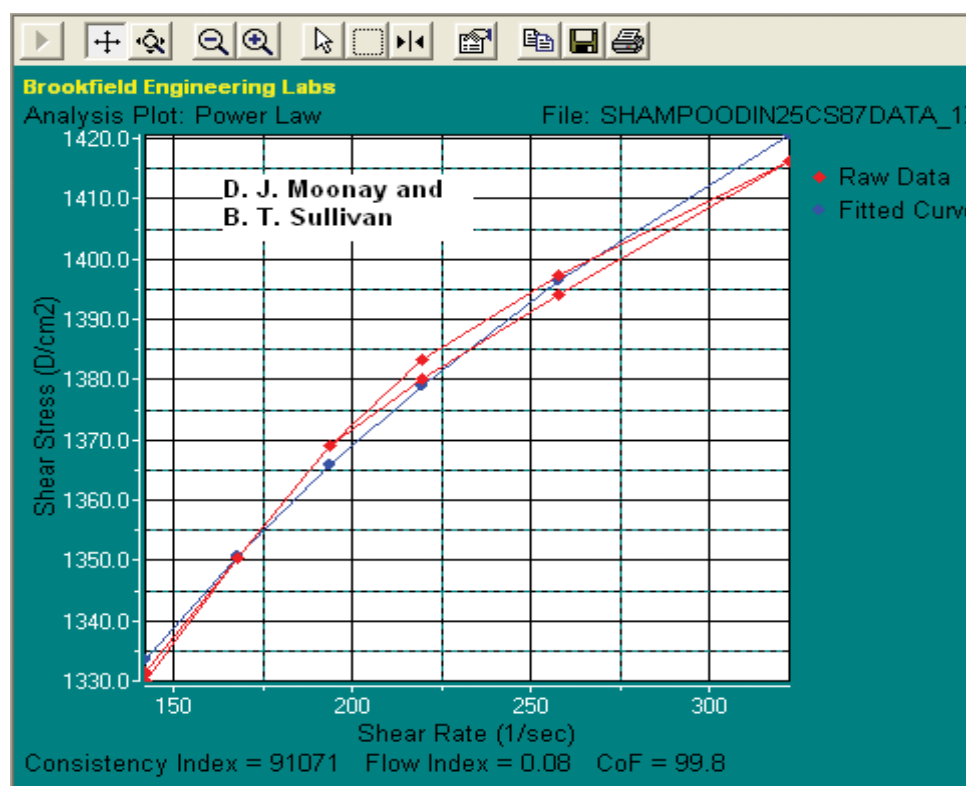

Figure VII-1

When  $n < 1$  the product is shear-thinning or Pseudoplastic. This means the apparent viscosity decreases as shear rate increases. The closer  $n$  is to 0, the more shear thinning the material is.

When  $n > 1$  the product is shear-thickening or Dilatant. Their apparent viscosity increases as shear rate increases.

#### When should you use it?

This model should be used with non-Newtonian, time-independent fluids that do not have a yield stress. These fluids will begin to flow under any amount of shear stress. Graphs of such material generally intersect the y-axis at 0.



### An Example of the Power Law Model at Work

Formulators at a personal care company would like to use a substitute ingredient to decrease cost. They use the Power Law model to evaluate the effect the new ingredient will have on the behavior of their shampoo. They need to know how it will behave during processing and how it will behave when it is being used by the consumer.

#### Shampoo

Flow Index ( $n$ ) = 0.08

Consistency Index ( $k$ ) = 91071 cP

With the new ingredient the shampoo has a flow index ( $n$ ) of 0.08. This indicates that the shampoo is shear-thinning enough to flow properly during processing and that it will flow properly for the end-user. The consistency index,  $k$ , indicates how the shampoo behaves when it experiences low shear rates. The power law values show that the shampoo becomes quite thin at process shear rates and therefore it can be easily pumped into filling equipment, hold tanks, etc. The consistency index of 91,071 cP shows that the shampoo is very viscous at low shear rates, and as a result, it will appear to customers to be “rich and creamy” while still being easy to apply.

## VII.2 The Herschel-Bulkley Model

$$\tau = \tau_o + k\dot{\gamma}^n \quad (\tau = \text{shear stress, } \tau_o = \text{yield stress, } k = \text{consistency index, } \dot{\gamma} = \text{shear rate, and } n = \text{flow index})$$

### What does it tell you?

The Herschel-Bulkley model is simply the Power Law model with the addition of  $\tau_o$  for yield stress. Yield stress,  $\tau_o$ , denotes how much shear stress is required to initiate flow. This model also provides a consistency index,  $k$ , which is a product's viscosity at 1 reciprocal second, and a flow index,  $n$ , which indicates the degree with which a material exhibits non-Newtonian flow behavior. Since Newtonian materials have linear shear stress vs. shear rate behavior and  $n$  describes the degree of non-Newtonian flow, the flow index essentially indicates how “non-linear” a material is. For Herschel-Bulkley fluids,  $n$  will always be greater than or less than 1.

When  $n < 1$  the product is shear-thinning or Pseudoplastic. This means the apparent viscosity decreases as shear rate increases. The closer  $n$  is to 0, the more shear thinning the material is.

When  $n > 1$  the product is shear-thickening or Dilatant. It's apparent viscosity increases as shear rate increases.

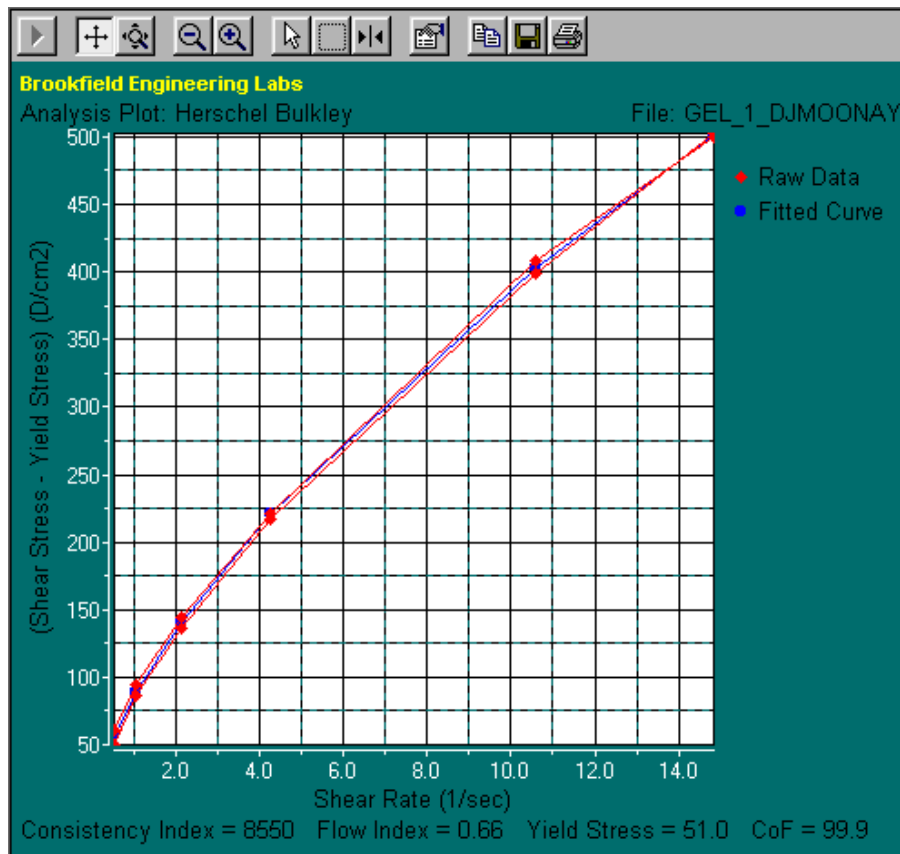

VII-2

### When should you use it?

The Herschel-Bulkley model should be used with non-Newtonian, time-dependent materials that have a yield stress. Products with a yield stress only begin to flow after a certain amount of shear stress is applied. As a result, the flow curve intersects the y-axis at a point greater than 0. After

yielding, the product creates a flow curve and behaves as a Power Law fluid so that  $n$  indicates where there is a shear-thinning or shear-thickening tendency. (In this case, if  $n = 1$ , the material is behaving as a Bingham fluid, which is discussed next.)

### **An Example of the Herschel-Bulkley Model at Work**

A company uses a gel-like substance as part of their production process. Upon arrival they test the material and apply the Herschel-Bulkley model to ensure it will perform correctly during process. The results in Figure VII-2 show that the consistency index is 8,550 cP, the flow index is 0.66, and the yield stress is 51.0 dynes/cm<sup>2</sup>. These results indicate that

this batch of gel does not quite meet specification. While the consistency index is within spec, the yield value is higher than normal so the fluid will not begin to flow as easily. With a flow index of 0.66, this batch is also less shear thinning than normal. Pump and mixer speeds must be adjusted before using this material.

#### **Gel-Like Substance**

$$n = 0.66$$

$$\tau_o = 51.0 \text{ dynes/cm}^2$$

$$k = 8550 \text{ cP}$$

### VII.3 The Bingham Model

$$\tau = \tau_o + \eta D \quad (\tau = \text{shear stress, } \tau_o = \text{yield stress, } \eta = \text{plastic viscosity, and } D = \text{shear rate})$$

#### What does it tell you?

The Bingham model indicates a product's yield stress,  $\tau_o$ , which is the amount of shear stress required to initiate flow. It also provides the plastic viscosity,  $\eta$ , which is the viscosity after a product yields.

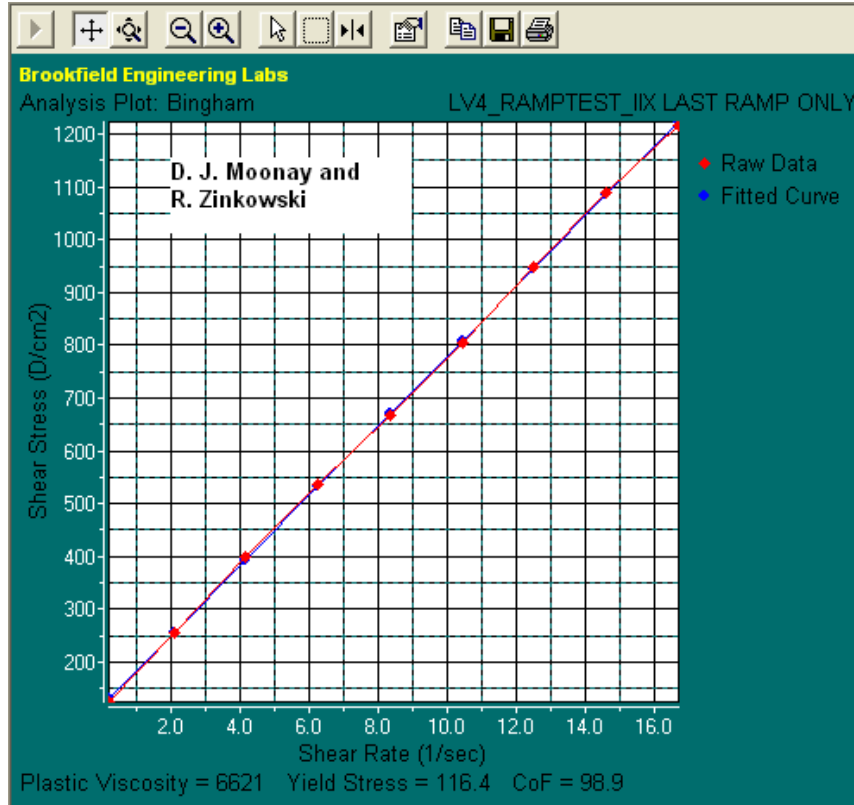

Figure VII-3

#### When should you use it?

This model should be used with non-Newtonian materials that have a yield stress and then behave in a Newtonian fashion once they begin to flow. As a result, the shear stress-shear rate plot forms a straight line after yielding. (Products that have a yield stress only begin to flow after a certain amount of shear stress is applied. They are also called “viscoplastic”. Their shear stress vs. shear rate graphs intersect the y-axis at a point greater than 0.)

### An Example of the Bingham Model at Work

A manufacturer of drilling fluid applies the Bingham Model to ensure the quality of their product. Results from a recent batch, shown in Figure VII-3, showed that the yield stress and plastic viscosity were both below the pass/fail criteria, which would cause the fluid to insufficiently hold-up the cuttings. The shipment was cancelled and the root-cause of the problem was identified.

#### Drilling Fluid

Plastic Viscosity ( $\eta$ ) = 6621 cP  
Yield Stress ( $\tau_o$ ) = 166.4 dynes/cm<sup>2</sup>

## VII.4 The Casson Model

$$\sqrt{\tau} = \sqrt{\tau_o} + \sqrt{\eta D} \quad (\tau = \text{shear stress, } \tau_o = \text{yield stress, } \eta = \text{plastic viscosity, and } D = \text{shear rate})$$

### What does it tell you?

The Casson model provides parameters similar to that of the Bingham model. However, unlike the Bingham model, it was developed for materials that exhibit non-Newtonian flow after yielding. The Casson model indicates the product's yield stress ( $\tau_o$ ) which is the amount of shear stress required to initiate flow, and the product's plastic viscosity,  $\eta$ , which is the viscosity of the product after it yields.

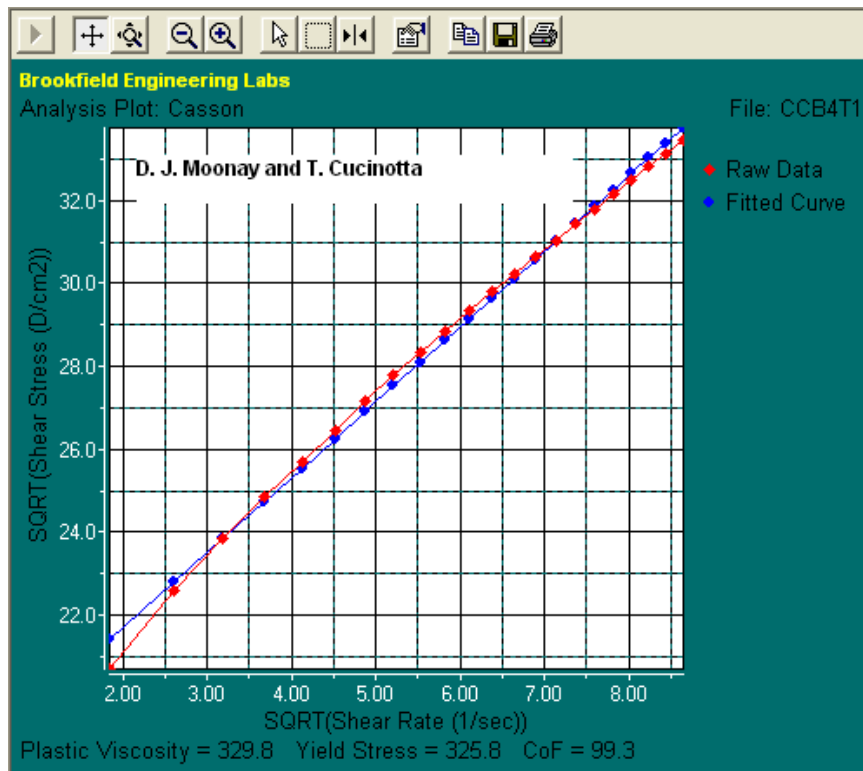

Figure VII-4

### When should you use it?

The Casson model should be used with non-Newtonian materials that have a yield stress and that do not exhibit a “Newtonian-like” behavior once they begin to flow. This model is most suitable for fluids that exhibit Pseudoplastic or shear thinning, flow behavior after yielding.

These fluids have a non-linear flow curve. The point at which it crosses the y-axis is the product's yield stress ( $\tau_o$ ). To protect the point at which the curve will intersect with the y-axis, the Casson model linearizes or straightens the plot by taking the square root of the data. To ensure accurate extrapolation to yield stress it is best to take some data at low shear rates.

## An Example of the Casson Model at Work

Before releasing a new over the counter gel, a pharmaceutical company needs to learn how it will behave which it is being used by the end consumer. They perform a full viscosity profile and apply the Casson model. From the results, shown in Figure VII-4, they learn that their ointment has a higher yield stress,  $\tau_o$ , and lower plastic viscosity,  $\eta$ , than they originally intended. As a result it is difficult or dispense from its container (due to the high yield stress) and it does not hold its shape very well (due to the low plastic viscosity), making it difficult to apply a small amount to the affected area of the skin. Based on this data, formulators are able to modify the ingredients accordingly. Once a formulation is established, multi-point tests and the Casson model are performed as a QC tool to check batches before and after processing.

### Pharmaceutical Gel

Plastic Viscosity ( $\eta$ ) = 329.8 cP  
Yield Stress ( $\tau_o$ ) = 325.8 dynes/cm<sup>2</sup>

## VII.5 Other Rheological Models

### The NCA/CMA Casson Model

$$(1 + a) \sqrt{\tau} = 2\sqrt{\tau_0} + (1 + a) \sqrt{\eta D} \quad (\tau = \text{shear stress}, \tau_0 = \text{yield stress}, \eta = \text{plastic viscosity}, \text{ and } \dot{\gamma} = \text{shear rate})$$

The NCA/CMA Casson model is designed by the National Confectioners Association and the Chocolate Manufacturers Association as the standard rheological model for the industry. This model determines yield and flow properties under specified conditions and closely approximates the plastic behavior of chocolate before final processing.

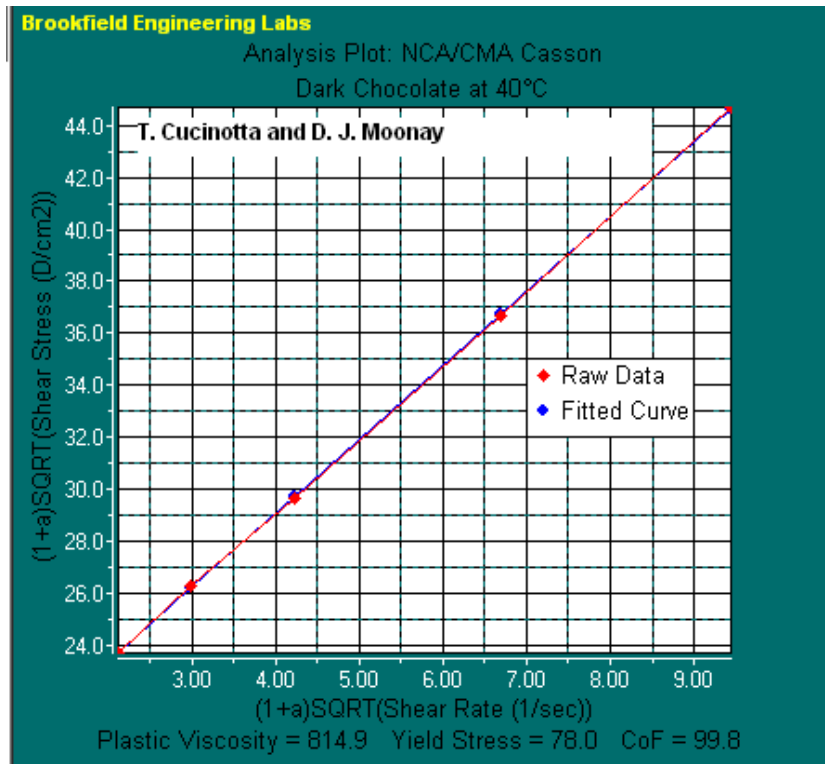

Figure VII-5

When chocolate is used for enrobing, it must have a yield stress high enough to stay in place once it enrobes the filling. In the case of decorating chocolate, the yield stress must be high enough so it can keep its shape once it has been squeezed into place through a nozzle. For molding chocolate, the plastic viscosity must be low enough to completely fill the mold.

(The NCA/CMA lists Brookfield's HA-spring range viscometer with a Small Sample Adapter, SC4-27 spindle and SC4-13R sample chamber as the approved apparatus.)

### The IPC Paste Model

$$\eta = kR^n$$

The IPC Paste Model was developed for solder pastes. It calculates the viscosity of solder pastes at 10rpm. The IPC Paste Model requires that the product be tested with a Brookfield Spiral Adapter at multiple speeds. More details can be found in the IPC-TM-650 Test Methods Manual (methods 2.4.34.2 and 2.4.3).



This model is a variation of the Power Law Model. Unlike the Power Law Model, which relates apparent viscosity to shear rate, the IPC Paste Model relates apparent viscosity to the testing speed (rpm).

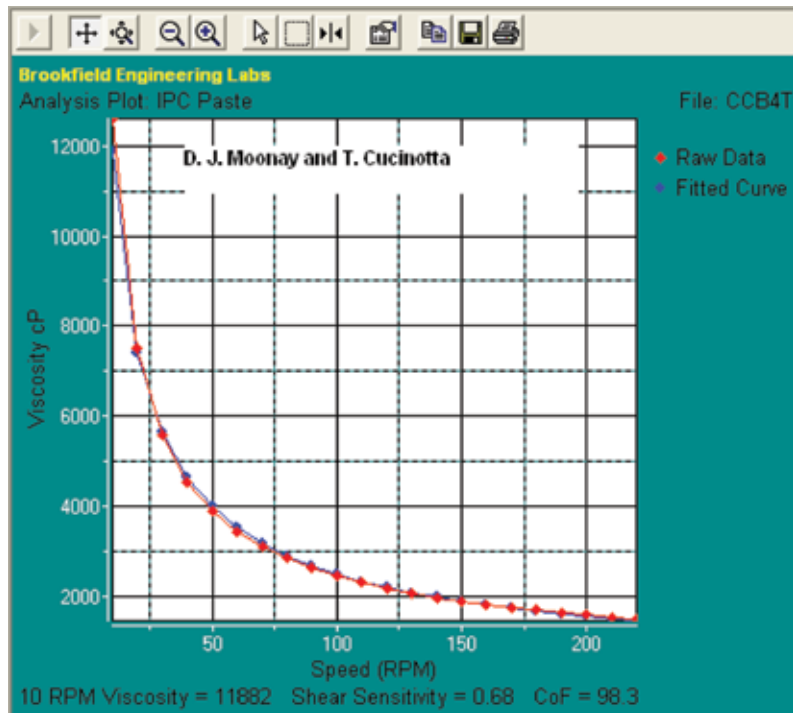

Figure VII-6

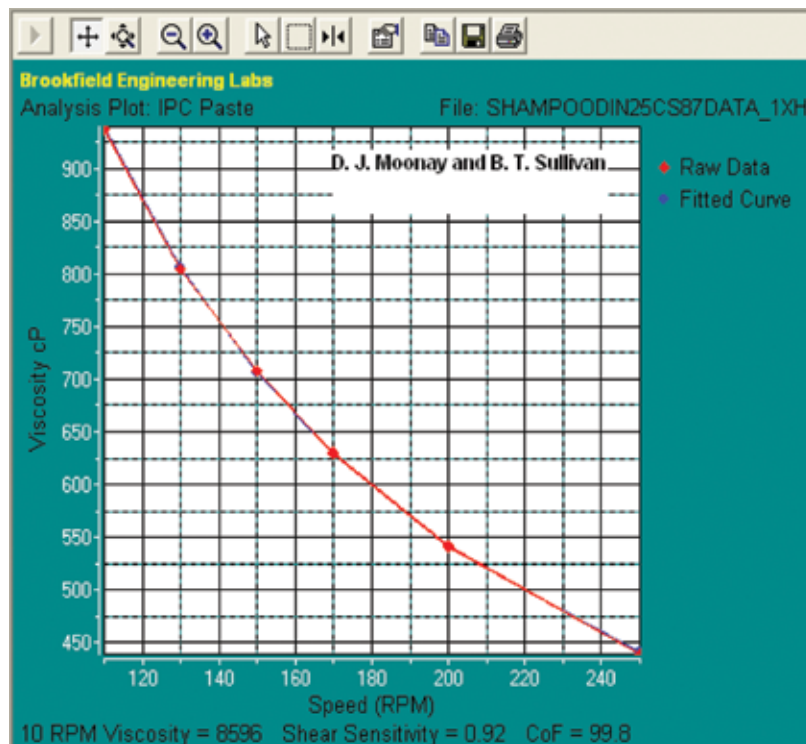

Figure VII-7

## Appendix A - Cone/Plate Rheometer Set-Up

This Cone/Plate version of the DV3T uses the same operating instruction procedures as described in this manual. However, the “gap” between the cone and the plate must be verified/adjusted before measurements are made. This is done by moving the plate (built into the sample cup) up towards the cone until the pin in the center of the cone touches the surface of the plate, and then by separating (lowering) the plate 0.0005 inch (0.013 mm).

When operating the Cone/Plate at elevated temperature, the gap must be set with the cup and spindle equilibrated at the temperature recommended. Maximum temperature for Cone/Plate operation is 80°C. Maximum operational temperature of sample cup is 100°C. Personal protection is recommended when controlling to temperatures above 80°C.



*Note:* Micrometer Adjustment Ring will become hot when controlling sample cup at temperatures above 50°C.

Programmable DV3T Cone/Plate Rheometers, S/N 50969 and higher, have an Electronic Gap Setting feature. This feature enables the user to easily find the 0.0005 inch gap setting that was established at Brookfield prior to shipment.

Brookfield recommends that the maximum particle size in the sample material for measurement with cone/plate geometry be less than 5 times the gap settings. A more conservative approach is to limit the maximum particle size to less than 10 times the gap setting.

The following information explains how to set the Electronic Gap and verify calibration of the DV3T Rheometer.

### A.1 Electronic Gap Setting Features

**TOGGLE SWITCH** allows you to enable/disable the Electronic Gap Setting Feature: left position is OFF (disabled), right position is ON (enabled).

**PILOT LIGHT** is the red (LED) light; when illuminated, it means the Electronic Setting Function is sensing (enabled).



*Note:* Be sure the light is off before introducing the test sample.

**CONTACT LIGHT** is the yellow (LED) light; when it first turns on, the “hit point” has been found.

**SLIDING REFERENCE MARKER** is used after finding the “hit point;” it is the reference for establishing the 0.0005 inch gap.

**MICROMETER ADJUSTMENT RING** is used to move the cup up or down in relation to the cone spindle. Turning the ring left (clockwise) lowers the cup; turning it right (counterclockwise) raises the cup. Each line on the ring represents one scale division and is equivalent to 0.0005 inch movement of the plate relative to the cone.

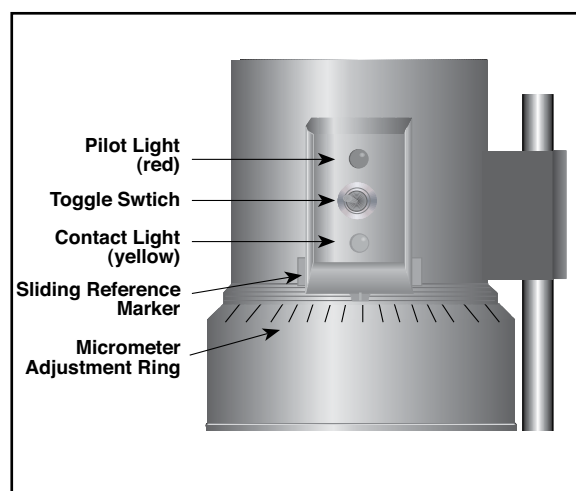
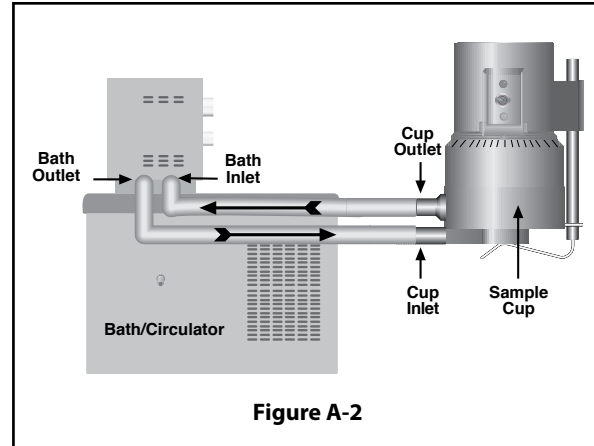

Figure A-1

## A.2 Setup

1. Be sure that the Rheometer is securely mounted to the Laboratory Stand, leveled and zeroed with no cone or cup attached and 0% torque is displayed.
2. **Figure A-2** shows a typical water bath setup. Connect the sample cup inlet/outlet ports to the water bath inlet and outlet and set the bath to the desired test temperature. Allow sufficient time for the bath to reach the test temperature.



3. The Rheometer has been supplied with a special cone spindle(s) which contains the Electronic Gap Setting feature. The “CPE” or “CPA” part number designation on the cone spindle verifies the Electronic Gap Setting feature.

*Note:* The “CPE” or “CPA” cone or cup cannot be used with earlier DV3T cone/plate Rheometers (below S/N50969) which do not have the electronic gap setting feature.

4. With the motor off, thread the cone spindle by using the spindle wrench to secure the rheometer coupling nut (see **Figure A-3**); gently push up on the coupling nut and hold this securely with the wrench. Thread the cone spindle by hand.

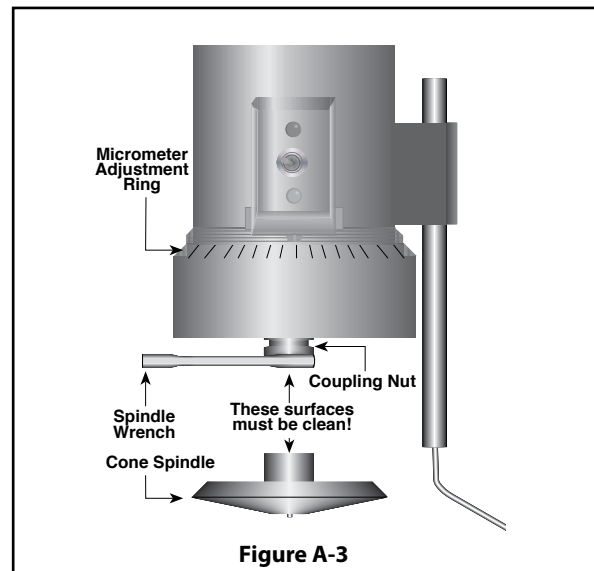

*Note:* Left Hand Threads.

5. Attach the cup, taking care not to hit the cone with the cup (**Figure A-4**), by positioning the cup against the mic ring and swinging the tension bar under the cup. The tension bar should have plastic tubing in place.

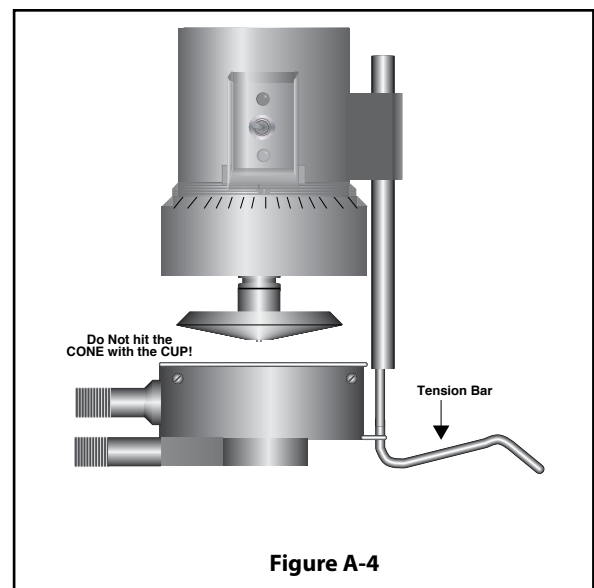

### A.3 Setting the Gap

1. Move the toggle switch to the right; this will turn on (enable) the Gap Setting Feature. The Pilot (red) light will be illuminated.  
**Note: The motor should be OFF.**
2. If the contact light (yellow) is illuminated, turn the micrometer adjustment ring clockwise (as you look down on the instrument) until the light is no longer illuminated (see **Figure A-5**).
3. If the yellow contact light is not illuminated, *slowly* turn the micrometer adjustment ring in small increments (one or two scale divisions) counter-clockwise.

Continue moving the micrometer adjustment ring *slowly* counter-clockwise until the contact light (yellow) first turns on. **THIS IS THE “HIT POINT.”**

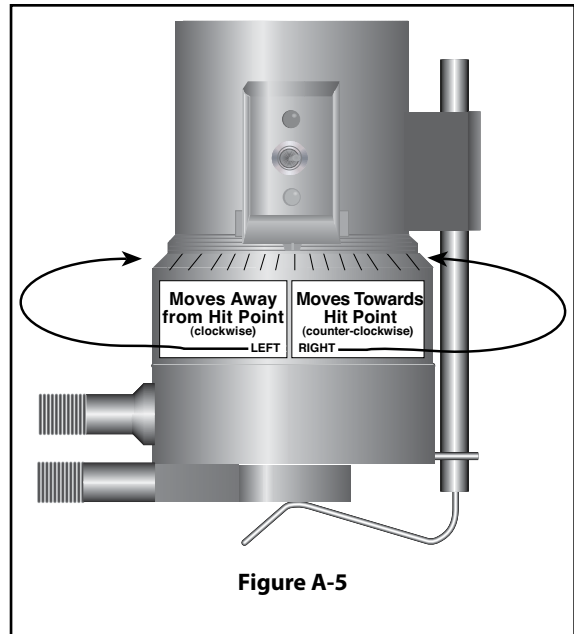

4. Adjust the sliding reference marker, right or left, to the closest full scale division mark (see **Figure A-6**).
5. Turn the micrometer adjustment ring one scale division to the left to meet the line on the sliding reference marker. **THE YELLOW CONTACT LIGHT SHOULD GO OFF.**
6. You have established the gap space needed for measurement. Now turn the toggle switch OFF (left); the red pilot light should go off.

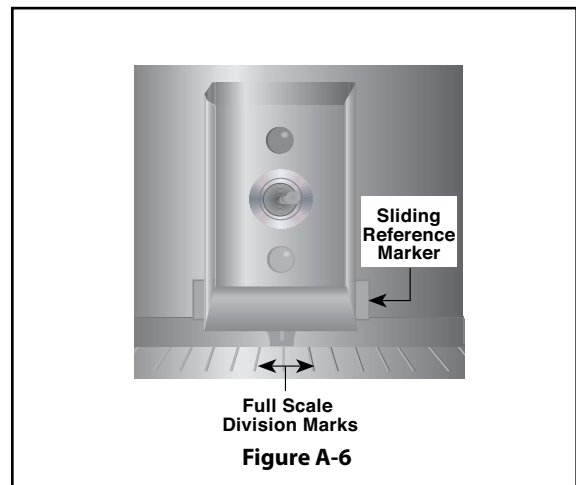

The viscosity of electrically conductive fluids may be affected if readings are taken with the Electronic Gap Setting feature “on”. Be sure to shut the feature “off” before taking readings!

7. Carefully remove the sample cup.

*Note:*

1. The cup may be removed and replaced without resetting the gap if the micrometer adjustment ring has not been moved.
2. Remove the spindle from the rheometer when cleaning.
3. Re-establish the hit point every time the spindle is attached/detached.

## A.4 Verifying Calibration

1. Determine the appropriate sample volume. Refer to Table A-1 to determine the correct sample volume required for the spindle to be utilized.
2. Select a Brookfield Viscosity Standard fluid that will give viscosity readings between 10% and 100% of full scale range. Refer to **Appendix B** for viscosity ranges of cone spindles.

Brookfield uses mineral oil viscosity standard fluids to calibrate Wells Brookfield Cone/Plate Rheometers at the factory. Brookfield recommends that customers use mineral oil viscosity standard fluids when you perform a calibration check.

If you decide to use a silicone viscosity standard fluid, do not use a fluid with a viscosity value greater than 5000 cP with a Cone/Plate. Brookfield offers a complete range of mineral oil viscosity standards suitable for use with Cone/Plates for viscosities above 5,000 cP or shear rates above 500 sec<sup>-1</sup>; see Table E-2 in Appendix F for a list of available fluids.

It is best to use a viscosity standard fluid that will be close to the maximum viscosity for a given cone spindle/speed combination.

**Example:** DV3TLV Rheometer, Cone Spindle CPA-42Z, Brookfield Silicone Viscosity Standard having a viscosity of 9.7 cP at 25°C

At 60 RPM, the full scale viscosity range is 10.0 cP. Thus, the Rheometer reading should be 97% torque and 9.7 cP viscosity  $\pm 0.197$  cP. The allowable error ( $\pm 0.197$  cP) is a combination of Rheometer accuracy and fluid tolerance (refer to **Interpretation of Calibration Test Results** in Appendix F).

3. With the motor off, remove the sample cup and place the viscosity standard fluid into the cup.

Cone Part No.	Sample Volume
CPA-40Z, CPE-40, CP-40	0.5 mL
CPA-41Z, CPE-41, CP-41	2.0 mL
CPA-42Z, CPE-42, CP-42	1.0 mL
CPA-51Z, CPE-51, CP-51	0.5 mL
CPA-52Z, CPE-52, CP-52	0.5 mL

4. Attach the sample cup to the Rheometer and allow sufficient time for the sample, cup and cone to reach temperature equilibrium.
5. Turn the motor on. Set the desired speed(s). Measure the viscosity and record the reading in both % torque and centipoise (cP).
6. Verify that the viscosity reading is within the allowable 1% deviation, as explained earlier, for the specific viscosity standard fluid(s) that you are using.

The CPE or CPA designation on the cone spindle indicates use with Electronic Gap Setting Cone/Plate Rheometers/Rheometers **only**.

## Appendix B - Viscosity Ranges

### Viscosity Range Tables

Viscosity ranges shown are for operational speeds 0.1 through 200 rpm.

#### LV Rheometer with LV spindles #1-4 and RV/HA/HB Rheometers with spindles #1-7

Viscosity Range (cP)		
Rheometer	Minimum	Maximum
DV3TLV	15	6,000,000
DV3TRV	100	40,000,000
DV3THA	200	80,000,000
DV3THB	800	320,000,000

#### Small Sample Adapter and Thermosel

SSA and Thermosel Spindle	Viscosity (cP)				Shear Rate sec <sup>-1</sup> ↻
	DV3TLV	DV3TRV	DV3THA	DV3THB	
Ⓢ SC4-14	58.6 - 1,171.00	625 -12,500,000	1,250 - 25,000,000	5,000 - 100,000,000	.40N
Ⓢ SC4-15	23.4 - 468,650	250 - 5,000,000	500 - 10,000,000	2,000 - 40,000,000	.48N
Ⓢ SC4-16	60 - 1,199,700	640 -12,800,000	1,280 - 25,600,000	5,120 - 102,400,000	.29N
SC4-18	1.5 - 30,000	16 - 320,000	32 - 640,000	128 - 2,560,000	1.32N
SC4-21	2.4 - 46,865	25 - 500,000	50 - 1,000,000	200 - 4,000,000	.93N
SC4-25	240 - 4,790,000	2,560 -51,200,000	5,120 -102,400,000	20,480 -409,600,000	.22N
SC4-27	11.7 - 234,325	125 - 2,500,000	250 - 5,000,000	1,000 - 20,000,000	.34N
SC4-28	23.4 - 468,650	250 - 5,000,000	500 - 10,000,000	2,000 - 40,000,000	.28N
SC4-29	46.9 - 937,300	500 -10,000,000	1,000 - 20,000,000	4,000 - 80,000,000	.25N
SC4-31	15 - 300,000	160 - 3,200,000	320 - 6,400,000	1,280 - 25,600,000	.34N
SC4-34	30 - 600,000	320 - 6,400,000	640 - 12,800,000	2,560 - 51,200,000	.28N
Ⓣ HT-DIN-81	3.4 - 10,000	36.5 - 10,000	73 - 10,000	292 - 10,000	1.29N
Ⓢ SC4-DIN-82	3.4 - 10,000	36.5 - 10,000	73 - 10,000	292 - 10,000	1.29N
Ⓢ SC4-DIN-83	11.3 - 37,898	121.3 - 50,000	242.6 - 50,000	970.4 - 50,000	1.29N

Ⓣ This spindle used with Thermosel only

Ⓢ This spindle used with Small Sample Adapter only

↻ N represents speed in RPM. For example, spindle SC4-14 operated at 5 rpm has a shear rate of  $0.40 \times 5 = 2.0 \text{ sec}^{-1}$

## UL Adapter

UL Spindle	Viscosity (cP)				Shear Rate sec-1
	DV3TLV	DV3TRV	DV3THA	DV3THB	
YULA-15 or 15Z	1 - 2,000	3.2 - 2,000	6.4 - 2,000	25.6 - 2,000	1.22N

## DIN Adapter Accessory

DAA Spindle	Viscosity (cP)				Shear Rate sec-1
	DV3TLV	DV3TRV	DV3THA	DV3THB	
85	0.6 - 5,000	6.1 - 5,000	12.2 - 5,000	48.8 - 5,000	1.29N
86	1.8 - 10,000	18.2 - 10,000	36.5 - 10,000	146 - 10,000	1.29N
87	5.7 - 50,000	61 - 50,000	121 - 50,000	485 - 50,000	1.29N

## Spiral Adapter

Spiral Spindle	Viscosity (cP)				Shear Rate sec-1
	DV3TLV	DV3TRV	DV3THA	DV3THB	
SA-70	98 - 98,500	1,050 - 1,050,000	2,100 - 2,100,000	8,400 - 8,400,000	0.667N

## Cone/Plate Rheometer

Cone Spindle	Viscosity (cP)				Shear Rate sec-1
	DV3TLV	DV3TRV	DV3THA	DV3THB	
CPA-40Z	.15 - 3,065	1.7 - 32,700	3.3 - 65,400	13.1 - 261,000	7.5N
CPA-41Z	.58 - 11,510	6.2 - 122,800	12.3 - 245,600	49.1 - 982,400	2.0N
CPA-42Z	.3 - 6,000	3.2 - 64,000	6.4 - 128,000	25.6 - 512,000	3.84N
CPA-51Z	2.4 - 47,990	25.6 - 512,000	51.7 - 1,024,000	205 - 4,096,000	3.84N
CPA-52Z	4.6 - 92,130	49.2 - 983,000	99.2 - 1,966,000	393 - 7,864,000	2.0N

## Helipath with T-Bar Spindle

T-Bar Spindle	Viscosity (cP)				Shear Rate sec-1
	DV3TLV	DV3TRV	DV3THA	DV3THB	
T-A	156 - 187,460	2,000 - 2,000,000	4,000 - 4,000,000	16,000 - 16,000,000	
T-B	312 - 374,920	4,000 - 4,000,000	8,000 - 8,000,000	32,000 - 32,000,000	
T-C	780 - 937,300	10,000 - 10,000,000	20,000 - 20,000,000	80,000 - 80,000,000	
T-D	1,560 - 1,874,600	20,000 - 20,000,000	40,000 - 40,000,000	160,000 - 160,000,000	
T-E	3,900 - 4,686,500	50,000 - 50,000,000	100,000 - 100,000,000	400,000 - 400,000,000	
T-F	7,800 - 9,373,000	100,000 - 100,000,000	200,000 - 200,000,000	800,000 - 800,000,000	

## Vane Spindles

Spindle	Torque Range	Shear Stress Range (Pa)	Viscosity Range cP (mPa•s)
V-71	NOT RECOMMENDED FOR USE ON LV TORQUE		
V-72	LV	.188-1.88	104.04-1.04K
V-73	LV	.938-9.38	502-5.02K
V-74	LV	9.38-93.8	5.09K-50.9K
V-75	LV	3.75-37.5	1.996K-19.96K
V-71	RV	.5-5	262-2.62K
V-72	RV	2-20	1.11K-11.1K
V-73	RV	10-100	5.35K-53.5K
V-74	RV	100-1K	54.3K-543K
V-75	RV	40-400	21.3K-213K
V-71	HA	1-10	524-5.24K
V-72	HA	4-40	2.22K-22.2K
V-73	HA	20-200	10.7K-107K
V-74	HA	200-2K	108.6K-1.086M
V-75	HA	80-800	42.6K-426K
V-71	HB	4-40	2.096K-20.96K
V-72	HB	16-160	8.88K-88.8K
V-73	HB	80-800	42.8K-428K
V-74	HB	800-8K	434.4K-4.344M
V-75	HB	320-3.2K	170.4K-1.704M
V-71	5XHB	20-200	10.48K-104.8K
V-72	5xHB	80-800	44.4K-444K
V-73	5XHB	400-4000	214K-2.14M
V-74	5xHB	4K-40K	2.172M-21.72M
V-75	5xHB	1.6K-16K	852K-8.52M

- Note:**
- 1 Pa = 10 dyne/cm<sup>2</sup>
  - Viscosity Range is given at rotational speed of 10 RPM
  - 5xHB is the highest torque range available
  - Not for use with DV-E Viscometers

M = 1 million  
 K = 1 thousand  
 Pa = Pascal  
 cP = Centipoise  
 mPa•s = Millipascal•seconds



## Special Considerations

In taking viscosity measurements with the DV3T Rheometer, there are two considerations which pertain to the low viscosity limit of effective measurement.

- 1) Viscosity measurements should be accepted within the equivalent % Torque Range from 10% to 100% for any combination of spindle/speed rotation.
- 2) Viscosity measurements should be taken under laminar flow conditions, not under turbulent flow conditions.

The first consideration has to do with the precision of the instrument. All DV3T Rheometers have an accuracy of +/- 1% of the range in use for any standard spindle or cone/plate spindle. (Note that accuracy values may be higher than 1% when using accessory devices with the DV3T). We discourage taking readings below 10% of range because the potential viscosity error of +/- 1% is a relatively high number compared to the instrument reading.

The second consideration involves the mechanics of fluid flow. All rheological measurements of fluid flow properties should be made under laminar flow conditions. Laminar flow is flow wherein all particle movement is in layers directed by the shearing force. For rotational systems, this means all fluid movement must be circumferential. When the inertial forces on the fluid become too great, the fluid can break into turbulent flow wherein the movement of fluid particles becomes random and the flow can not be analyzed with standard math models. This turbulence creates a falsely high rheometer reading with the degree of non-linear increase in reading being directly related to the degree of turbulence in the fluid.

For the following geometries, we have found that an approximate transition point to turbulent flow occurs:

- |                      |                    |
|----------------------|--------------------|
| 1) No. 1 LV Spindle: | 15 cP at 60 RPM    |
| 2) No. 2 LV Spindle: | 100 cP at 200 RPM  |
| 3) No. 1 RV Spindle: | 100 cP at 50 RPM   |
| 4) UL Adapter:       | 0.85 cP at 60 RPM  |
| 5) SC4-18/13R:       | 1.25 cP at 240 RPM |

Turbulent conditions will exist in these situations whenever the RPM/cP ratio exceeds the values listed above.

## Effect on accuracy when using accessory devices

The Brookfield rheometer has a stated accuracy of +/- 1% of the range in use. This stated accuracy applies when the rheometer is used in accordance with the operating instructions detailed in the instrument instruction manual and the calibration test fluid is used in accordance with the instructions provided by the fluid supplier (including the critical parameters of temperature control and stated fluid accuracy). Brookfield's accuracy statement of +/- 1% of the range in use applies to the Brookfield rotational rheometer when used with the standard spindles supplied with the instrument, including LV spindles 1 through 4 (supplied with LV series rheometers), RV spindles 2 through 7 (supplied with RV series rheometers), and HV series spindles 2 through 7 (supplied with HA series rheometers and HB series rheometers) in a 600 mL low form Griffin beaker.

Brookfield offers a range of accessories for use with the Brookfield rheometer to accommodate special measurement circumstances. These accessories, while offering added capability to the user, also contribute to an expanded measurement tolerance beyond the instrument accuracy of +/- 1% of the range in use. This expanded measurement tolerance is a function of many parameters including spindle geometry, accessory alignment accuracy, sample volume requirement, and sample introduction techniques. The effect of these elements on measurement tolerance must be considered when verifying the calibration of your Brookfield rheometer. Sample temperature in all test circumstances is very important, and will also add an additional expanded tolerance depending on the temperature control system and the calibration verification tests begin with the standard rheometer spindles as detailed above. Once the calibration of the rheometer itself is confirmed, the expanded tolerance of the measurement system may be determined using accessory devices. In many cases, this additional tolerance will be very minimal, but as a general statement, the addition of +/- 1% of the range in use is reasonable for accessories.

## Appendix C - Variables in Viscosity Measurements

As with any instrument measurement, there are variables that can affect a Rheometer measurement. These variables may be related to the instrument (Rheometer), or the test fluid. Variables related to the test fluid deal with the rheological properties of the fluid, while instrument variables would include the Rheometer design and the spindle geometry system utilized.

### Rheological Properties

Fluids have different rheological characteristics that can be described by Rheometer measurements. We can then work with these fluids to suit our lab or process conditions.

There are two categories of fluids:

- Newtonian** - These fluids have the same viscosity at different Shear Rates (different RPMs) and are called Newtonian over the Shear Rate range they are measured.
- Non-Newtonian** - These fluids have different viscosities at different shear rates (different RPMs). They fall into two groups:
  - 1) Time Independent non-Newtonian
  - 2) Time Dependent non-Newtonian

#### Time Independent

- Pseudoplastic** - A pseudoplastic material displays a decrease in viscosity with an increase in shear rate, and is also known as “shear thinning”. If you take Rheometer readings from a low to a high RPM and then back to the low RPM, and the readings fall upon themselves, the material is time independent pseudoplastic (shear thinning).

#### Time Dependent

- Thixotropic** - A thixotropic material has decreasing viscosity under constant shear rate. If you set a Rheometer at a constant speed recording cP values over time and find that the cP values decrease with time, the material is thixotropic.
  - If you take rheometer readings from a low RPM to a high RPM and then back to the low RPM, and the readings are lower for the descending step, the material is time dependant, thixotropic.

Brookfield publication, “*More Solutions to Sticky Problems*”, includes a more detailed discussion of rheological properties and non-Newtonian behavior.

## Rheometer Related Variables

Most fluid viscosities are found to be non-Newtonian. They are dependent on Shear Rate, time of test and the spindle geometry conditions. The specifications of the Rheometer spindle and chamber geometry will affect the viscosity readings. If one reading is taken at 2.5 RPM, and a second at 50 RPM, the two cP values produced will be different because the readings were made at different shear rates. The faster the spindle speed, the higher the shear rate.

The shear rate of a given measurement is determined by: the rotational speed of the spindle, the size and shape of the spindle, the size and shape of the container used and therefore the distance between the container wall and the spindle surface.

A repeatable viscosity test should control or specify the following:

- 1) Test temperature
- 2) Sample container size (or spindle/chamber geometry)
- 3) Sample volume
- 4) Rheometer model
- 5) Spindle used
- 6) Whether or not to attach the guard leg
- 7) Test speed or speeds (or the shear rate)
- 8) Length of time or number of spindle revolutions to record viscosity
- 9) How the sample was prepared and/or loaded into the container

## Appendix D - Spindle Entry Codes and SMC/SRC Values

Each spindle has a two digit entry code which is entered via the keypad on the DV3T. The entry code allows the DV3T to calculate Viscosity, Shear Rate and Shear Stress values.

Each spindle has two constants which are used in these calculations. The Spindle Multiplier Constant (SMC) used for viscosity and shear stress calculations, and the Shear Rate Constant (SRC), used for shear rate and shear stress calculations. Note that where SRC = 0, no shear rate/shear stress calculations are done and the data displayed is zero (0) for these functions.

*Table D-1*  
(Continued on following page)

SPINDLE	ENTRY CODE	SMC	SRC
RV1	01	1	0
RV2	02	4	0
RV3	03	10	0
RV4	04	20	0
RV5	05	40	0
RV6	06	100	0
RV7	07	400	0
HA1	01	1	0
HA2	02	4	0
HA3	03	10	0
HA4	04	20	0
HA5	05	40	0
HA6	06	100	0
HA7	07	400	0
HB1	01	1	0
HB2	02	4	0
HB3	03	10	0
HB4	04	20	0
HB5	05	40	0
HB6	06	100	0
HB7	07	400	0
LV1	61	6.4	0
LV2	62	32	0
LV3	63	128	0
LV4 or 4B2	64	640	0
LV5	65	1280	0
LV-2C	66	32	0.212
LV-3C	67	128	0.210
SA-70	70	105	0.677

SPINDLE	ENTRY CODE	SMC	SRC	
T-A	91	20	0	
T-B	92	40	0	
T-C	93	100	0	
T-D	94	200	0	
T-E	95	500	0	
T-F	96	1000	0	
ULA	00	0.64	1.223	
DIN-81	81	3.7	1.29	
DIN-82	82	3.75	1.29	
DIN-83	83	12.09	1.29	
DIN-85	85	1.22	1.29	
DIN-86	86	3.65	1.29	
DIN-87	87	12.13	1.29	
SC4-14	14	125	0.4	
SC4-15	15	50	0.48	
SC4-16	16	128	0.29	
SC4-18	18	3.2	1.32	
SC4-21	21	5	0.93	
SC4-25	25	512	0.22	
SC4-27	27	25	0.34	
SC4-28	28	50	0.28	
SC4-29	29	100	0.25	
SC4-31	31	32	0.34	
SC4-34	34	64	0.28	
CP-40, CPE-40 or CPA-40Z	40	0.327	7.5	
CP-41, CPE-41 or CPA-41Z	41	1.228	2	
CP-42, CPE-42 or CPA-42Z	42	0.64	3.84	
CP-51, CPE-51 or CPA-51Z	51	5.178	3.84	
CP-52, CPE-52 or CPA-52Z	52	9.922	2	
SPINDLE	ENTRY CODE	SMC	SRC	YMC
V-71	71	2.62	0	0.5
V-72	72	11.1	0	2
V-73	73	53.5	0	10
V-74	74	543	0	100
V-75	75	213	0	40

*Table D-1*  
(continued from previous page)

Table D-2 lists the model codes and spring torque constants for each Rheometer model.

Table D-2

MODEL	TK	MODEL CODE ON DV3T SCREEN
DV3TLV	0.09375	LV
DV3TL3	0.234375	2.5LV
DV3TL5	0.46875	5LV
DV3TRQ	0.25	1/4 RV
DV3TRH	0.5	1/2 RV
DV3TRV	1	RV
DV3THA	2	HA
DV3TA2	4	2HA
DV3TA3	5	2.5HA
DV3THB	8	HB
DV3TB2	16	2HB
DV3TB3	20	2.5HB
DV3TB5	40	5HB

The full scale viscosity range for any DV3T model and spindle may be calculated using the equation:

$$\text{Full Scale Viscosity Range [cP]} = \text{TK} * \text{SMC} * \frac{10,000}{\text{RPM}}$$

where:

TK = DV3T Torque Constant from Table D-2

SMC = Spindle Multiplier Constant from Table D-1

The Shear Rate calculation is:

$$\begin{aligned} (\text{Shear Stress (D/cm}^2)) &= \text{Viscosity (P)} * \text{Shear Rate (1/sec)} \\ &= \text{TK} * \text{SMC} * \text{SRC} * \text{TORQ} \end{aligned}$$

## Appendix E - Spindle Entry Codes and Range Coefficients

The range coefficient is a convenient tool for quickly determining the maximum viscosity that can be measured with a specific spindle/speed combination. Identify the spindle in use and the torque range (LV, RV, HA, HB) of the Viscometer/Rheometer. Look up the Range Coefficient in the following table. Divide the Range Coefficient by the spindle speed to determine the maximum viscosity in centipoise that can be measured.

E.g. RV Viscometer with RV3 spindle: Range Coefficient is 100,000. At 50 RPM, the maximum viscosity that can be measured is 100,000/50 or 2,000 cP.

The Entry Code is the two digit number used to identify the spindle in use when operating a standard digital Viscometer/Rheometer.

Table E-1  
(Continued on following page)

Spindle	Entry Code	Range Coefficient			
		LV	RV	HA	HB
RV1	01	937	10,000	20,000	80,000
RV2	02	3,750	40,000	80,000	320,000
RV3	03	9,375	100,000	200,000	800,000
RV4	04	18,750	200,000	400,000	1,600,000
RV5	05	37,500	400,000	800,000	3,200,000
RV6	06	93,750	1,000,000	2,000,000	8,000,000
RV7	07	375,000	4,000,000	8,000,000	32,000,000
HA1	01	937	10,000	20,000	80,000
HA2	02	3,750	40,000	80,000	320,000
HA3	03	9,375	100,000	200,000	800,000
HA4	04	18,750	200,000	400,000	1,600,000
HA5	05	37,500	400,000	800,000	3,200,000
HA6	06	93,750	1,000,000	2,000,000	8,000,000
HA7	07	375,000	4,000,000	8,000,000	32,000,000
HB1	01	937	10,000	20,000	80,000
HB2	02	3,750	40,000	80,000	320,000
HB3	03	9,375	100,000	200,000	800,000
HB4	04	18,750	200,000	400,000	1,600,000
HB5	05	37,500	400,000	800,000	3,200,000
HB6	06	93,750	1,000,000	2,000,000	8,000,000
HB7	07	375,000	4,000,000	8,000,000	32,000,000
LV1	61	6,000	64,000	128,000	512,000
LV2	62	30,000	320,000	640,000	2,560,000
LV3	63	120,000	1,280,000	2,560,000	10,240,000
LV4 or 4B2	64	600,000	6,400,000	12,800,000	51,200,000
LV5	65	1,200,000	12,800,000	25,600,000	102,400,000
LV-2C	66	30,000	320,000	640,000	2,560,000
LV-3C	67	120,000	1,280,000	2,560,000	10,240,000

Spindle	Entry Code	Range Coefficient			
		LV	RV	HA	HB
T-A	91	18,750	200,000	400,000	1,600,000
T-B	92	37,440	400,000	800,000	3,200,000
T-C	93	9,3600	1,000,000	2,000,000	8,000,000
T-D	94	187,200	2,000,000	4,000,000	16,000,000
T-E	95	468,000	5,000,000	10,000,000	40,000,000
T-F	96	936,000	10,000,000	20,000,000	80,000,000
Spiral	70	98,400	1,050,000	2,100,000	8,400,000
ULA	00	600	6,400	12,800	51,200
HT-DIN-81	81	3,420	36,500	73,000	292,000
SC4-DIN-82	82	3,420	36,500	73,000	292,000
SC4-DIN-83	83	11,340	121,300	242,600	970,400
ULA-DIN-85	85	1,144	12,200	24,400	97,600
ULA-DIN-86	86	3,420	36,500	73,000	292,000
ULA-DIN-87	87	11,340	121,300	242,600	970,400
SC4-14/6R	14	117,200	1,250,000	2,500,000	10,000,000
SC4-15/7R	15	46,880	500,000	1,000,000	4,000,000
SC4-16/8R	16	120,000	1,280,000	2,560,000	10,240,000
SC4-18/13R	18	3,000	32,000	64,000	256,000
SC4-21/13R	21	4,688	50,000	100,000	400,000
SC4-25/13R	25	480,000	5,120,000	10,240,000	40,960,000
SC4-27/13R	27	23,440	250,000	500,000	2,000,000
SC4-28/13R	28	46,880	500,000	1,000,000	4,000,000
SC4-29/13R	29	93,750	1,000,000	2,000,000	8,000,000
SC4-31/13R	31	30,000	320,000	640,000	2,560,000
SC4-34/13R	34	60,000	640,000	1,280,000	5,120,000
CPA-40, CPE-40, CP-40	40	307	3,270	6,540	26,160
CPA-41, CPE-41, CP-41	41	1,151	12,280	24,560	98,240
CPA-42, CPE-42, CP-42	42	600	6,400	12,800	51,200
CPA-51, CPE-51, CP-51	51	4,854	51,780	103,560	414,240
CPA-52, CPE-52, CP-52	52	9,300	99,220	198,440	793,760
V-71	71	2,456	26,200	52,400	209,600
V-72	72	10,404	111,000	222,000	888,000
V-73	73	50,146	535,000	1,070,000	4,280,000
V-74	74	508,954	5,430,000	10,860,000	43,440,000
V-75	75	199,645	2,130,000	4,260,000	8,520,000

*Table E-1*  
(Continued on previous page)



## Appendix F - Calibration Procedures

The accuracy of the DV3T is verified using viscosity standard fluids which are available from Brookfield Engineering Laboratories or your local Brookfield agent. Viscosity standards are Newtonian, and therefore, have the same viscosity regardless of spindle speed (or shear rate). Viscosity standards, calibrated at 25°C, are shown in **Table F-1** (Silicone Oils) and **Table F-2** (Mineral Oils).

For more help you can go to the website,  
[www.brookfieldengineering.com](http://www.brookfieldengineering.com), and download the video.

**Container size:** For Viscosity Standards < 30,000 cP, use a 600 mL Low Form Griffin Beaker having a working volume of 500 mL.

For Viscosity Standards ≥ 30,000 cP, use the fluid container.

Inside Diameter: 3.25”(8.25 cm)

Height: 4.75”(12.1 cm)

Note: Container may be larger, but may not be smaller.

**Temperature:** As stated on the fluid standard label: (+/-) 0.1°C

**Conditions:** The DV3T should be set according to the operating instructions. The water bath must be stabilized at test temperature. Rheometers with the letters “LV” or “RV” in the model designation must have the guard leg attached (see Appendix G for more information on the guard leg).

Normal 25°C Standard Fluids		High Temperature Standard Fluids
Viscosity (cP)	Viscosity (cP)	Three Viscosity/Temperatures**
5	5,000	HT-30,000
10	12,500	HT-60,000
50	30,000	HT-100,000
100	60,000	
500	100,000	**25°C, 93.3°C, 149°C
1,000		Refer to Brookfield catalog for more information

Table F-1

MINERAL OIL VISCOSITY STANDARD FLUIDS	
BEL Part No.	Viscosity (cP) 25°C
B29	29
B200	200
B600	600
B1060	1,060
B2000	2,000
B10200	10,200
B21000	21,000
B73000	73,000
B200000	200,000
B360000	360,000

Table F-2

## Brookfield Viscosity Standard Fluid General Information

We recommend that Brookfield Viscosity Standard Fluids be replaced on an annual basis, one year from date of initial use. These fluids are pure silicone and are not subject to change over time. However, exposure to outside contaminants through normal use requires replacement on an annual basis. Contamination may occur by the introduction of solvent, standard of different viscosity or other foreign material.

Viscosity Standard Fluids may be stored under normal laboratory conditions. Disposal should be in accordance with state, local and federal regulations as specified on the material safety data sheet.

Brookfield Engineering Laboratories does not recertify Viscosity Standard Fluids. We will issue duplicate copies of the Certificate of Calibration for any fluid within two years of the purchase date. Brookfield Viscosity Standard Fluids are reusable provided they are not contaminated. Normal practice for usage in a 600 mL beaker is to return the material from the beaker back into the bottle. When using smaller volumes in accessories such as Small Sample Adapter, UL Adapter or Thermosel, the fluid is normally discarded.

## Calibration Procedure for LV #1-3 (#61-63) and RV, HA, HB #1-6 Brookfield Spindles

**Please note that the LV #4 (64) and RV, HA, HB #7 (07) spindles have been omitted from this procedure. Brookfield does not recommend the use of these spindles to perform a calibration check on your instrument. Reasons pertain to the small amount of spindle surface that makes contact with the viscosity standard, the difficulty of establishing the immersion mark precisely and the need for precise temperature control at 25°C in the immediate vicinity of the spindle.**

Follow these steps using one of the recommended spindles to verify calibration on your instrument:

- 1) Place the viscosity standard fluid (in the proper container) into the water bath.
- 2) Lower the DV3T into measurement position (with guard leg if LV or RV series Rheometer is used).
- 3) Attach the spindle to the Rheometer. If you are using a disk-shaped spindle, avoid trapping air bubbles beneath the disk by first immersing the spindle at an angle, and then connecting it to the Rheometer.
- 4) The viscosity standard fluid, together with the spindle, should be immersed in the bath for a minimum of 1 hour, stirring the fluid periodically, prior to taking measurements.
- 5) After 1 hour, check the temperature of the viscosity standard fluid with an accurate thermometer.
- 6) If the fluid is at test temperature ( $\pm 0.1^{\circ}\text{C}$  of the specified temperature, normally  $25^{\circ}\text{C}$ ), measure the viscosity and record the Rheometer reading. **Note: The spindle must rotate at least five (5) times before readings are taken.**
- 7) The viscosity reading should equal the cP value on the fluid standard to within the combined accuracies of the Rheometer and the viscosity standard (as discussed in the section, at the end of this Appendix, entitled Interpretation of Calibration Test Results) which appears later in this section.

## Calibration Procedure for a Small Sample Adapter

Brookfield recommends a two step check. First, verify the calibration of the rheometer using the standard rheometer spindles (LV #1-3, RV #2-6, HA #2-6 and HB #2-6 or cone/plate spindles) as detailed in this appendix. Second, verify the calibration of the rheometer using the Small Sample Adapter. The use of an accessory device may increase the accuracy of measurement associated with the DV3T.

When a Small Sample Adapter is used, the water jacket is connected to the water bath and the water is stabilized at the proper temperature:

- 1) Put the proper amount of viscosity standard fluid into the sample chamber. The amount varies with each spindle/chamber combination (refer to the Small Sample Adapter instruction manual).
- 2) Place the sample chamber into the water jacket.
- 3) Put the spindle into the test fluid and attach the extension link, coupling nut and free hanging spindle (or directly attach the solid shaft spindle) to the DV3T.
- 4) Allow 30 minutes for the viscosity standard, sample chamber and spindle to reach test temperature.
- 5) Measure the viscosity and record the Rheometer reading. **Note: The spindle must rotate at least five (5) times before readings are taken.**

## Calibration Procedure for a Thermo System

Brookfield recommends a two step check. First verify the calibration of the rheometer using the standard rheometer spindles (LV #1-3, RV #2-6, HA #2-6 and HB #2-6 or cone/plate spindles) as detailed in this appendix. Second verify the calibration of the rheometer using the Thermo System. The use of an accessory device may increase the accuracy of measurement associated with the DV3T.

When a Thermo System is used, the controller stabilizes the Thermo Container at the test temperature.

- 1) Put the proper amount of HT viscosity standard fluid into the HT-2 sample chamber. The amount varies with the spindle used (refer to the Thermo System instruction manual).
- 2) Place the sample chamber into the Thermo Container.
- 3) Put the spindle into the test fluid and attach the extension link, coupling nut and free hanging spindle (or directly attach the solid shaft spindle) to the DV3T.
- 4) Allow 30 minutes for the viscosity standard, sample chamber and spindle to reach test temperature.
- 5) Measure the viscosity and record the Rheometer reading. **Note: The spindle must rotate at least five (5) times before readings are taken.**

## Calibration Procedure using UL or DIN Adapters

Brookfield recommends a two step check. First, verify the calibration of the rheometer using the standard rheometer spindles (LV #1-3, RV #2-6, HA #2-6 and HB #2-6 or cone/plate spindles) as detailed in this appendix. Second, verify the calibration of the rheometer using the UL or DIN Adapters. The use of an accessory device may increase the accuracy of measurement associated with the DV3T.

When a UL or DIN UL Adapter is used, the water bath is stabilized at the proper temperature:

- 1) Put the proper amount of viscosity standard fluid into the UL Tube (refer to the UL Adapter instruction manual).
- 2) Attach the spindle (with extension link and coupling nut) onto the DV3T.
- 3) Attach the tube to the mounting channel.
- 4) Lower the tube into the water bath reservoir, or if using the ULA-40Y water jacket, connect the inlet/outlets to the bath external circulating pump.
- 5) Allow 30 minutes for the viscosity standard, sample chamber and spindle to reach test temperature.
- 6) Measure the viscosity and record the Rheometer reading. **Note: The spindle must rotate at least five (5) times before readings are taken.**

### Calibration Procedure using a Helipath Stand and T-Bar Spindles

When a Helipath Stand and T-Bar spindles are used:

- 1) Remove the T-bar spindle and select a standard LV (#1-3) or RV, HA, HB (#1-6) spindle. Follow the procedures for LV (#1-3) and RV, HA, HB (#1-6) Brookfield spindles outlined above.
- 2) **T-Bar spindles should not be used for verifying calibration of the DV3T Rheometer.**

### Calibration Procedure for Spiral Adapter

Brookfield recommends a two step check. First, verify the calibration of the rheometer using the standard rheometer spindles (LV #1-3, RV #2-6, HA #2-6 and HB #2-6 or cone/plate spindles) as detailed in this appendix. Second, verify the calibration of the rheometer using the Spiral Adapter. The use of an accessory device may increase the accuracy of measurement associated with the DV3T.

- 1) Place the viscosity standard fluid (in the proper container) into the water bath (refer to the Spiral Adapter instruction manual).
- 2) Attach the spindle to the rheometer. Attach chamber (SA-1Y) and clamp to the rheometer.
- 3) Lower the DV3T into measurement position. Operate the rheometer at 50 or 60 RPM until the chamber is fully flooded.
- 4) The viscosity standard fluid, together with the spindle, should be immersed in the bath for a minimum of 1 hour, stirring the fluid periodically (operate at 50 or 60 RPM periodically), prior to taking measurements.
- 5) After 1 hour, check the temperature of the viscosity standard fluid with an accurate thermometer.
- 6) If the fluid is at test temperature ( $\pm 0.1^{\circ}\text{C}$  of the specified temperature, normally  $25^{\circ}\text{C}$ ), measure the viscosity and record the rheometer reading. **Note: The spindle must rotate at least five (5) times for one minute, whichever is greater before readings are taken.**
- 7) The viscosity reading should equal the cP value on the viscosity fluid standard to within the combined accuracies of the rheometer and the standard (as discussed in the section entitled, Interpretation of Calibration Test Results). However, instrument accuracy is  $\pm 2\%$  of the maximum viscosity range and not the standard 1%.

## Calibration Procedure for Cone/Plate Rheometers

- 1) Follow the above procedures for mechanically adjusting the setting of the cone spindle to the plate.
- 2) Refer to Appendix A; Table A-1, and determine the correct sample volume required for the selected spindle.
- 3) Select a viscosity standard fluid that will give viscosity readings between 10% and 100% of full scale range. Refer to Appendix B for viscosity ranges of cone spindles. Consult with Brookfield or an authorized dealer to determine which fluid is appropriate.

It is best to use a viscosity standard fluid that will be close to the maximum viscosity for a given cone spindle/speed combination.

**Example:** DV3TLV Rheometer, Cone CP-42, Fluid 10  
Having a viscosity of 9.7 cP at 25°C

At 60 RPM, the full scale viscosity range is 10.0 cP. Thus, the Rheometer reading should be 97% torque and 9.7 cP viscosity  $\pm$  0.197 cP (0.1 cP for the rheometer plus 0.097 cP for the fluid). The accuracy is a combination of Rheometer and fluid tolerance (refer to Interpretation of Calibration Test Results).

- 4) With the rheometer stopped, remove the sample cup and place the viscosity standard fluid into the cup, waiting 10 minutes for temperature equilibrium.
- 5) Connect the sample cup to the Rheometer. Allow sufficient time for temperature to reach equilibrium. Typically 15 minutes is the maximum time that you must wait. Less time is required if spindle and cup are already at test temperature.
- 6) Measure the viscosity and record the Rheometer reading in both % torque and centipoise (cP).

**Notes:** 1) **The spindle must rotate at least five (5) times before a viscosity reading is taken.**

- 2) The use of Brookfield Viscosity Standard fluids in the range of 5 cP to 5000 cP is recommended for cone/plate instruments. Please contact Brookfield Engineering Laboratories or an authorized dealer if your calibration procedure requires more viscous standards.
- 3) Select a viscosity standard fluid that will give viscosity readings between 10% and 100% of full scale range. Refer to Appendix B for viscosity ranges of cone spindles. Do not use a silicone viscosity standard fluid with a viscosity value greater than 5000 cP with a Cone/Plate Rheometer. Brookfield offers a complete range of mineral oil viscosity standards suitable for use with Cone/Plate Rheometers as shown in Table E-2. Consult with Brookfield or an authorized dealer to determine which fluid is appropriate.

## Interpretation of Calibration Test Results:

When verifying the calibration of the DV3T, the instrument and viscosity standard fluid error must be combined to calculate the total allowable error.

The DV3T is accurate to (+/-) 1% of the range in use when using spindles LV #1-3, RV #2-6, HA #2-6 and HB #2-6. When using an accessory device with the DV3T such as Small Sample Adapter, UL Adapter, Thermosel, Spiral Adapter, and DIN Adapter the accuracy value may be increased. In general the increase in accuracy will be minimal, however, it could be as much as 1% for a total accuracy of +/- 2% of the range in use.

Brookfield Viscosity Standards Fluids are accurate to (+/-) 1% of their stated value.

**Example:** Calculate the acceptable range of viscosity using DV3TRV with RV-3 Spindle at 2 RPM; Brookfield Standard Fluid 12,500 with a viscosity of 12,257 cP at 25°C:

- 1) Calculate full scale viscosity range using the equation:

$$\text{Full Scale Viscosity Range [cP]} = \text{TK} * \text{SMC} * \frac{10,000}{\text{RPM}}$$

Where:

TK - 1.0 from **Table D-2**

SMC = 10 from **Table D-1**

$$\text{Full Scale Viscosity Range} = \frac{1 * 10 * 10,000}{2} = 50,000 \text{ cP}$$

The viscosity is accurate to (+/-) 500 cP (which is 1% of 50,000)

- 2) The viscosity standard fluid is 12,257 cP. Its accuracy is (+/-)1% of 12,257 or (+/-)122.57 cP.
- 3) Total allowable error is (122.57 + 500) cP = (+/-) 622.57 cP.
- 4) Therefore, any viscosity reading between 11,634.4 and 12,879.6 cP indicates that the Rheometer is operating correctly. Any reading outside these limits may indicate a Rheometer problem. Contact the Brookfield technical sales department or your local Brookfield dealer/distributor with test results to determine the nature of the problem.

**Example:** Calculate the acceptable accuracy for viscosity measurement using DV3TLV with SC4-21 spindle in Small Sample Adapter at 6, 12, and 30 RPM. Brookfield viscosity standard fluid 100 cPs has an actual value of 101.5 cP at 25°C.

- 1) Calculate the full scale viscosity range either by using the Spindle Range Coefficient in Appendix B of More Solutions to Sticky Problems or by using the Auto Range button on your rheometer.

The Spindle Range Coefficient for the 21 spindle on an LV Torque instrument is 4,688.

At 6 RPM, the Full Scale Range (FSR) viscosity is 781 cP. Allow +/- 1% for the rheometer and +/- 1% for the Small Sample Adapter. Total allowable accuracy is:

$$\pm 2\% \times 781 \text{ cP} = \pm 15.6 \text{ cP}$$

A similar calculation at 12 RPM gives FSR = 391 cP:  $\pm 2\% \times 391 \text{ cP} = \pm 7.8 \text{ cP}$

A similar calculation at 30 RPM gives FSR = 156 cP:  $\pm 2\% \times 156 \text{ cP} = \pm 3.1 \text{ cP}$

- 2) The Viscosity Standard Fluid is 101.5 cP. Its accuracy is:

$$\pm 1\% \times 101.5 \text{ cP} = \pm 1.015 \text{ cP} \text{ or roughly } \pm 1.0 \text{ cP} \text{ for further calculations.}$$

- 3) Total accuracy is the sum of the values in (1) and (2):

At 6 RPM, accuracy is:  $15.6 \text{ cP} + 1.0 \text{ cP} = \pm 16.6 \text{ cP}$

At 12 RPM, accuracy is:  $7.8 \text{ cP} + 1.0 \text{ cP} = \pm 9.8 \text{ cP}$

At 30 RPM, accuracy is:  $3.1 \text{ cP} + 1.0 \text{ cP} = \pm 4.1 \text{ cP}$

- 4) Therefore, at each speed, the acceptable windows within which the measured viscosity value must lie is calculated relative to the viscosity value of the standard:

At 6 RPM: 84.9 cP to 118.1 cP  
At 12 RPM: 91.7 cP to 111.3 cP  
At 30 RPM: 97.4 cP to 105.6 cP

If your measured values fall outside of these windows, contact Brookfield or your authorized dealer to discuss your results and determine whether your instrument is out of calibration.

## Appendix G - The Brookfield Guardleg

The guard leg was originally designed to protect the spindle during use. The first applications of the Brookfield Rheometer included hand held operation while measuring fluids in a 55-gallon drum. It is clear that under those conditions the potential for damage to the spindle was great. Original construction included a sleeve that protected the spindle from side impact. Early RV guard legs attached to the dial housing and LV guard legs attached to the bottom of the pivot cup with a twist and lock mechanism.

The current guard leg is a band of metal in the shape of the letter U with a bracket at the top that attaches to the pivot cup of a Brookfield Viscometer/Rheometer. Because it must attach to the pivot cup, the guard leg cannot be used with a Cone/Plate instrument. A guard leg is supplied with all LV and RV series instruments, but not with the HA or HB series. It's shape (shown in Figure G-1 and G-2) is designed to accommodate the spindles of the appropriate spindle set; therefore, the RV guard leg is wider than the LV due to the large diameter of the RV #2 spindle. They are not interchangeable.

The calibration of the Brookfield Viscometer/Rheometer is determined using a 600 mL Low Form Griffin Beaker. The calibration of LV and RV series instruments includes the guard leg. The beaker wall (for HA/HB instruments) or the guard leg (for LV/RV instruments) define what is called the "outer boundary" of the measurement. The spindle factors for the LV, RV, and HA/HB spindles were developed with the above boundary conditions. The spindle factors are used to convert the instrument torque (expressed as the dial reading or %Torque value) into centipoise. Theoretically, if measurements are made with different boundary conditions, e.g., without the guard leg or in a container other than 600 mL beaker, then the spindle factors found on the Factor Finder cannot be used to accurately calculate an absolute viscosity. Changing the boundary conditions does not change the viscosity of the fluid, but it does change how the instrument torque is converted to centipoise. Without changing the spindle factor to suit the new boundary conditions, the calculation from instrument torque to viscosity will be incorrect.

Practically speaking, the guard leg has the greatest effect when used with the #1 & #2 spindles of the LV and RV spindle sets (Note: RV/HA/HB #1 spindle is not included in standard spindle set). Any other LV (#3 & #4) or RV (#3 - #7) spindle can be used in a 600 mL beaker with or without the guard leg to produce correct results. The HA and HB series Viscometers/Rheometers are not supplied with guard legs in order to reduce the potential problems when measuring high viscosity materials. HA/HB spindles #3 through #7 are identical to those spindle numbers in the RV spindle set. The HA/HB #1 & #2 have slightly different dimensions than the corresponding RV spindles. This dimensional difference allows the factors between the RV and HA/HB #1 & #2 spindles to follow the same ratios as the instrument torque even though the boundary conditions are different.

The recommended procedures of using a 600 mL beaker and the guard leg are difficult for some customers to follow. The guard leg is one more item to clean. In some applications the 500 mL of test fluid required to immerse the spindles in a 600 mL beaker is not available. In practice, a smaller vessel may be used and the guard leg is removed. The Brookfield Viscometer/Rheometer will produce an accurate and repeatable torque reading under any measurement circumstance. However, the conversion of this torque reading to centipoise will only be correct if the factor used was developed for those specific conditions. Brookfield has outlined a method for re-calibrating a Brookfield Viscometer/Rheometer to any measurement circumstance in More Solutions to Sticky Problems. It is important to note that for many rheometer users, the true viscosity is not as important as a repeatable day to day value. This repeatable value can be obtained without any special effort for any measurement circumstance. But, it



should be known that this type of torque reading will not convert into a correct centipoise value when using a Brookfield factor if the boundary conditions are not those specified by Brookfield.

The guard leg is a part of the calibration check of the Brookfield LV and RV series Viscometer/Rheometer. Our customers should be aware of its existence, its purpose and the effect that it may have on data. With this knowledge, the rheometer user may make modifications to the recommended method of operation to suit their needs.

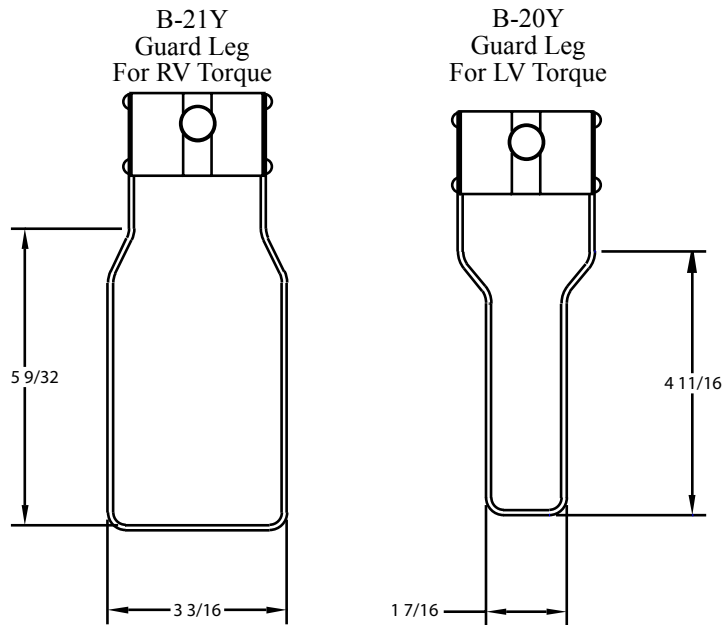

Figure G-1 - Brookfield Guard Leg

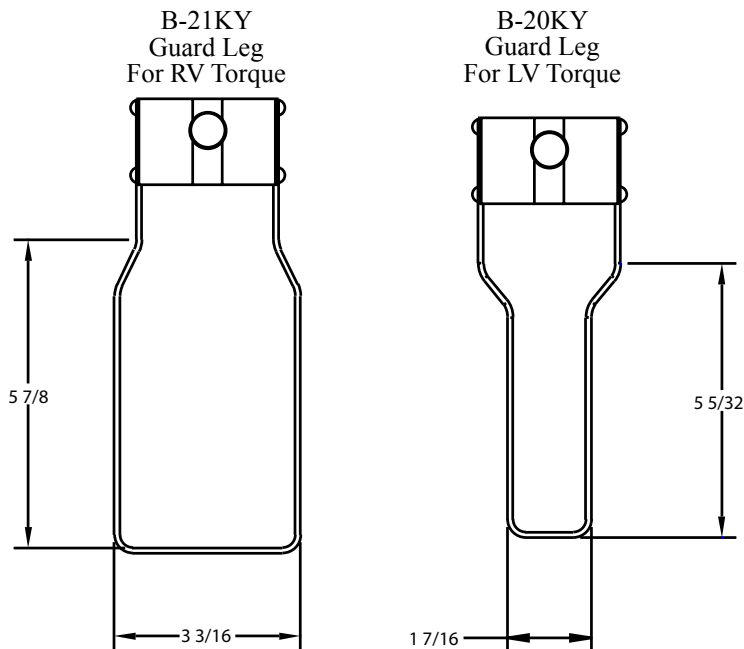

Figure G-2 - Brookfield EZ-Lock Guard Leg

## Appendix H - Speed Selection

Brookfield Rheometers offer a variety of speeds to provide for a wide range of viscosity measurement capabilities. Brookfield has traditionally supplied a defined set of speeds with specific Torque ranges:

LV	0.3, 0.6, 1.5, 3.0, 6.0, 12, 30, 60
RV	0.5, 1.0, 2.0, 2.5, 4.0, 5.0, 10, 20, 50, 100

The DV3T and earlier Brookfield DV-III Series Rheometers offer additional speeds to enhance measurement capabilities. The DV3T offers speeds from 0.01 - 250 RPM with two options for speed selection: numeric key pad for direct entry; Scroll List. The user can choose from these two entry options by using the Navigation Bar (see Section IV.3: Global Settings). The Scroll List is the format used with previous versions of the DV-III rheometer. You may choose the Scroll List to provide the rheometer user with a familiar method for speed selection. The Scroll List can be customized to limit the available speeds and to add new speeds to the list of standard speeds.

## Appendix I - Laboratory Stands

Model G is the standard laboratory stand which comes with the DV3T Rheometer.

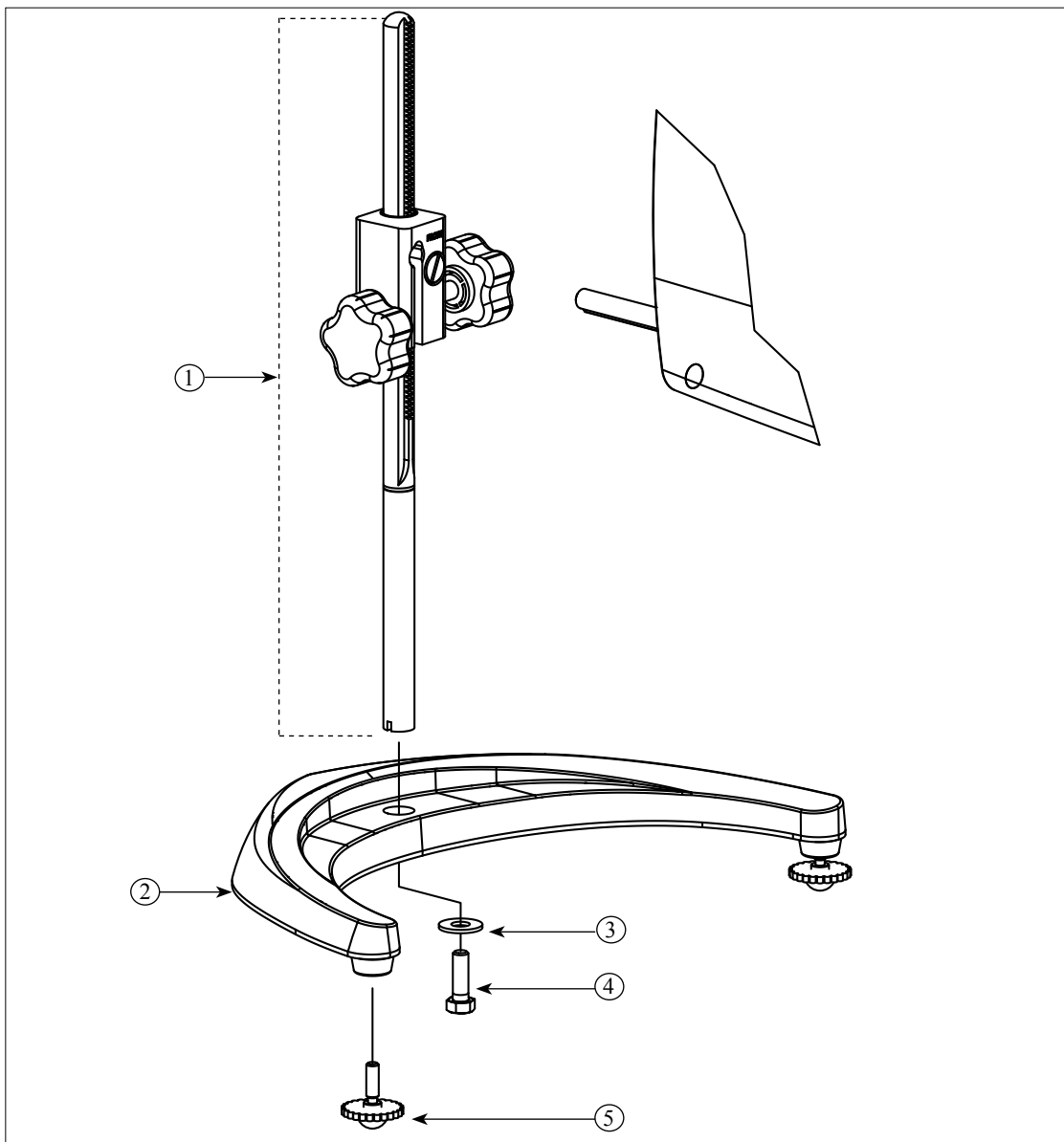

Item	Part No.	Description	Qty
1	VS-CRA-14S	Upright Rod and Clamp Assembly	1
	VS-CRA-18S	Upright Rod and Clamp Assembly	Optional
2	GV-1201	Base, includes 2 GV-1203 leveling screws	1
3	GV-1203	Leveling Screws available separately or in assembly above	2
4	502028071S33B	Flat Washer 5/16 X 7/8 X .071	1
5	50S311832S01B	Screw, 5/16 - 18 X 1" Hex Head	1

Figure I-1: Model G Laboratory Stand

Model QB is an optional laboratory stand which can be ordered for use with the DV3T Rheometer. The advantage is the rapid speed of movement for lowering and raising the rheometer head.

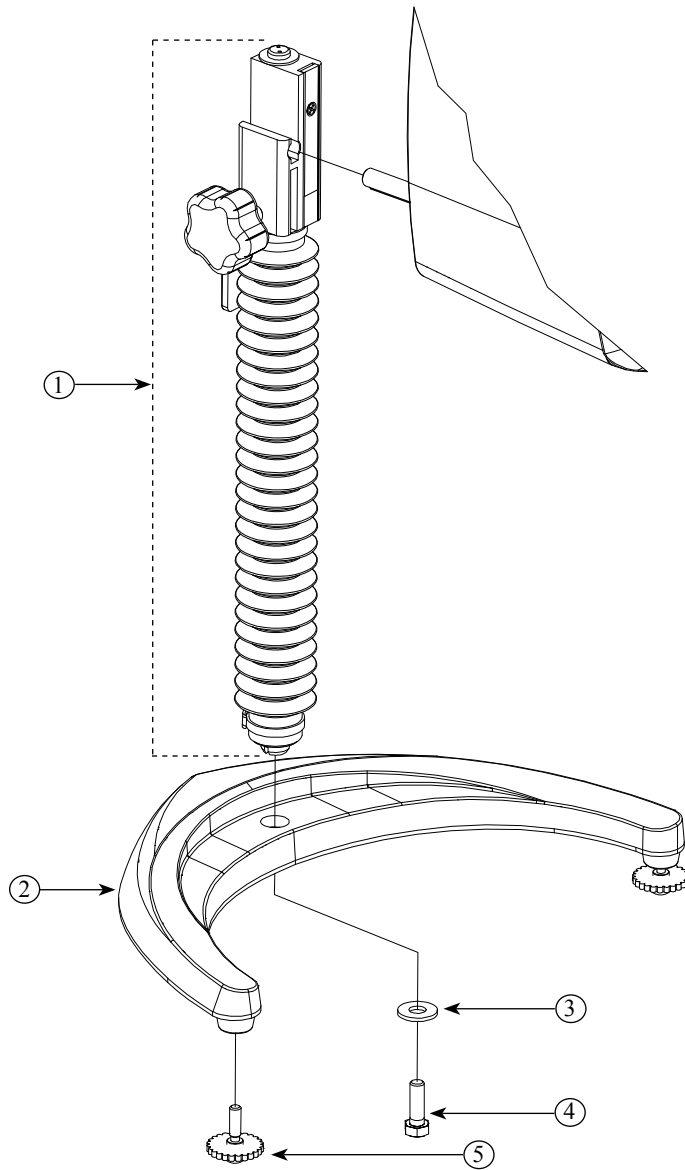

Item	Part No.	Description	Qty
1	VSQA-100Y	Upright Rod and Clamp Assembly	1
2	GV-1201	Base, includes 2 GV-1203 leveling screws	1
3	502028071S33B	Flat Washer 5/16 X 7/8 X .071	1
4	50S311832S01B	Screw, 5/16 - 18 X 1" Hex Head	1
5	GV-1203	Leveling Screws available separately or in assembly above	2

Figure I-2: Model QB Laboratory Stand

## Unpacking

Check carefully to see that all the components are received with no concealed damage.

- 1 Base, GV-1201, with 2 Leveling Screws, GV-1203, packed in a cardboard carton
- 1 Upright Rod with attached Clamp Assembly in the instrument case

## Assembly (Refer to Figures I-1 or I-2)

1. Remove the base assembly from the carton.
2. Remove the screw and washer from the upright rod. Place the rod and clamp assembly into the hole in the top of the base.

**Note:** The “Front” designation on the clamp assembly should face toward you.

3. Rotate the rod/clamp assembly slightly until the slot on the bottom of the rod intersects the pin located in the base.
4. While holding the rod and base together, insert the slotted screw and washer as shown and tighten securely.
5. Adjust the tension screw so that the clamp assembly is not loose on the upright rod.

## Rheometer Mounting

Insert the Rheometer mounting rod into the hole (with the cut-away slot) in the clamp assembly. Adjust the instrument level until the bubble is centered from right to left and tighten the clamp knob (clockwise). Use the leveling screws to “fine” adjust the rheometer level.

**Note:** If the Digital Rheometer cannot be leveled, check to insure that the rod is installed with the gear rack facing forward.



**Caution:** Do not tighten the clamp knob unless the rheometer mounting rod is inserted in the clamp assembly.



**Caution:** Do not use the DV3T Rheometer with any laboratory stand that does not utilize the GV-1201 base. This large base is necessary for stability of the DV3T Rheometer during use. Earlier versions of the Brookfield Laboratory Stand including the Model A and Model S should not be used with the DV3T.

## Operation

Rotate the UP/DOWN knob to raise or lower the rheometer. Adjust the tension screw if the UP/DOWN movement of the rheometer head is not acceptable, i.e. too easy or too difficult.

## Appendix J - DVE-50A Probe Clip

Probe Clip DVE-50A is supplied with all model DV3T Rheometers, DV-III Rheometers, and Digital Temperature Indicators. It is used to attach the RTD temperature probe to the LV Guard Leg (Part No. B-20Y) or 600 mL low form Griffin beaker. Figure J-1 is a view of the Probe Clip, showing the hole into which the RTD probe is inserted, and the slot which fits onto the LV guard leg. When inserting the RTD probe into the Probe Clip, the upper part of the Clip is compressed by squeezing the points shown in Figure J-1.

*Note:* All Viscometer/Rheometer models — except LV — use the Probe Clip as shown in Figure J-3.

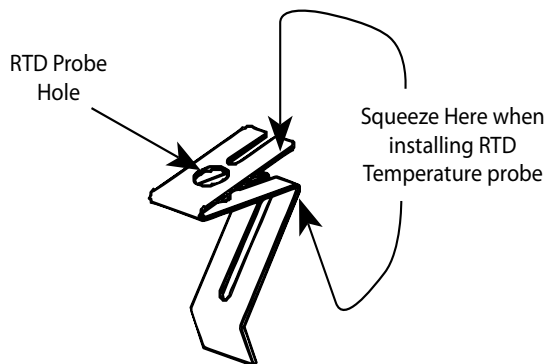

Figure J-1

Figure J-2 shows the Probe Clip (with RTD temperature probe installed) mounted on the LV guard leg.

Figure J-3 shows the Probe Clip mounted in a 600 mL low form Griffin beaker. This mounting may be used with LV, RV, HA and HB series instruments.



**Caution:** Temperature probe must not contact the spindle during measurement.

*Note:* The RTD probe must be parallel to the beaker wall so as not to interfere with the viscosity measurement.

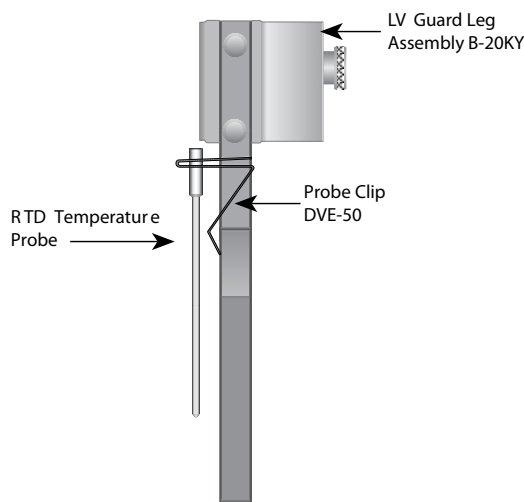

Figure J-2

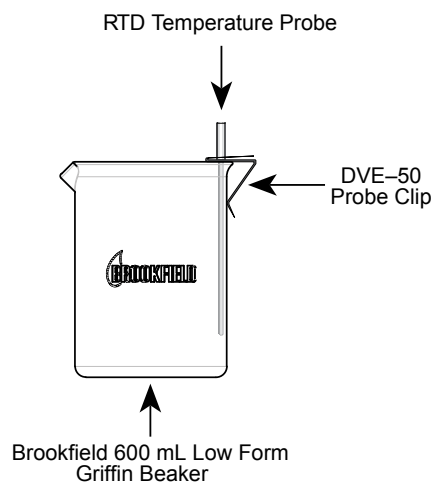

Figure J-3

## Appendix K - Screen Protector

The Brookfield DV3T Rheometer is provided with a screen protector that can be applied to the touch screen surface. This screen protector is designed for prolonged use. Brookfield recommends replacing the screen protector within 1 year of application. The screen protector is provided in a kit (part number GV-1019) that includes the following items:

- Two screen protectors (with mounted applicator and tabs)
- One screen cloth (part number GV-1045)
- One soft card
- Instructions printed on the package

Retain the soft card and screen cloth with any unused screen protector.

### Install the Screen Protector

Installation instructions for the screen protector are available in three methods:

1. Read printed instructions on the package
2. View the instructional video on the Brookfield YouTube Channel:  
[www.youtube.com/user/BrookfieldEng](http://www.youtube.com/user/BrookfieldEng)
3. Read the expanded printed instructions in this appendix (see below).



**A failure to properly install the screen protector may result in a disabled touch screen.**

Step 1:

- Turn off the DV3T rheometer (power down) prior to installation.
- Clean the DV3T touch screen with the screen cloth prior to installation. Any debris, dust, or oil on the touch screen may prevent proper adhesion of the screen protector.
- Identify Tab 1 and Tab 2 prior to removing any protective layer. Peel back adhesive Tab 1, from the bottom, to expose half of the protector (see Figure K-1).
- Do not touch the exposed surface of the adhesive side of the screen protector.

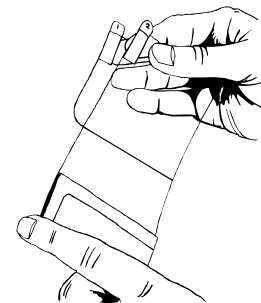

Figure K-1

Step 2:

- Alignment of the screen protector to the bezel (frame) of the DV3T is critical. Be sure to avoid mis-alignment which may result in the screen protector contacting or locating under the bezel (frame). A foam alignment tool is attached to the screen protector's outer layer and should be used to locate the screen protector to the lower right hand corner of the touch screen (see Figure K-2).

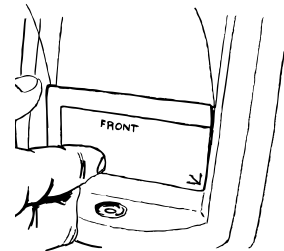

Figure K-2



**Failure to properly align (install) the screen protector could result in a failure of the touch screen.**

Step 3:

- Completely remove Tab 1 (see Figure K-3).
- Lightly press the screen protector to the touch screen.
- Inspect the alignment of the screen protector. If the screen protector is touching the bezel (frame), then remove and reapply.

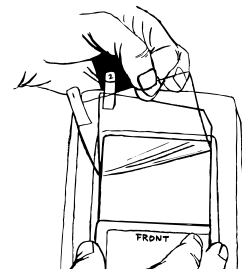

Figure K-3

Step 4:

- Peel back Tab 2 all the way to remove the backing, which also removes the alignment tool (see Figure K-4). The screen protector is now in place.

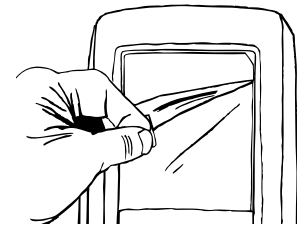

Figure K-4

Step 5:

- Use the soft card provided to push trapped air bubbles from the center of the screen to the edge (see Figure K-5). Small bubbles should go away within 48 hours.
- DO NOT use the soft card to push the screen protector under the bezel (frame). If the screen protector is not properly aligned, remove and reapply. Two screen protectors are provided in this package in case the first attempt is unsuccessful.
- Test the viscometer (power on) to ensure that the screen protector is properly attached. The screen protector is properly aligned if the DV3T Rheometer responds normally to a touch on the touch screen. If the DV3T Rheometer is unresponsive to touch then remove the screen protector and reapply.

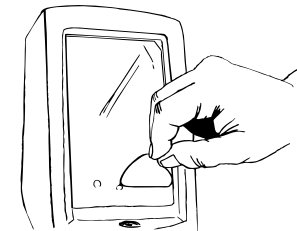

Figure K-5

## Removal of the Screen Protector

The screen protector should be replaced when it has become dirty. It can be easily removed from the DV3T Rheometer by hand. The upper right hand corner of the screen protector has a small angle cut. Use a finger nail or blunt object to pry the screen protector away from the touch screen and peel it off of the touch screen.



**Be careful not to scratch the touch screen when removing the screen protector.**





## Appendix L - Fault Diagnosis and Troubleshooting

Listed are some of the more common problems that you may encounter while using your Rheometer.

### ❑ Spindle Does Not Rotate

- ✓ Make sure the rheometer is plugged in.
- ✓ Check the voltage rating on your rheometer (115, 220V); it must match the wall voltage.
- ✓ Make sure the motor is ON and the desired rpm is selected.

### ❑ Spindle Wobbles When Rotating or Looks Bent

- ✓ Make sure the spindle is tightened securely to the rheometer coupling.
- ✓ Check the straightness of all other spindles; replace if bent.
- ✓ Inspect rheometer coupling and spindle coupling mating areas and threads for dirt; clean threads on spindle coupling with a 3/56 left-hand tap.
- ✓ Inspect threads for wear; if the threads are worn, the unit needs service (see Appendix O). Check to see if spindles rotate eccentrically or wobble. There is an allowable runout of 1/32-inch in each direction (1/16-inch total) when measured from the bottom of the spindle rotating in air.
- ✓ Check to see if the rheometer coupling appears bent; if so, the unit is in need of service (see Appendix O: Warranty Repair and Service).

### ❑ Inaccurate Readings

- ✓ Verify spindle, speed and model selection.
- ✓ Verify spindle selection is correct on DV3T.
- ✓ If % readings are under-range (less than 10%), the display will flash; change spindle and/or speed.
- ✓ “EEEE” on the digital display means the unit is over-range (greater than 100%); reduce speed and/or change spindle.
- ✓ Verify test parameters: temperature, container, volume, method. Refer to:
  - “More Solutions to Sticky Problems”, Section III
  - “DV3T Rheometer Operating Instructions”, Appendix C: Variables in Viscosity Measurements
- ✓ Perform a calibration check; follow the instructions in Appendix F.
- ✓ Verify tolerances are calculated correctly.
- ✓ Verify the calibration check procedures were followed exactly.

If the unit is found to be out of tolerance, the unit may be in need of service. See Appendix O for details on Warranty Repair and Service.

### ❑ Rheometer Will Not Return to Zero

- ✓ Rheometer is not level
  - Check with spindle out of the sample.
  - Adjust the laboratory stand.

- ✓ Pivot point or jewel bearing faulty
  - Perform an Oscillation Check\*
    - ✓ Remove the spindle and turn the motor OFF; select display to % torque mode.
    - ✓ Gently push up on the rheometer coupling.
    - ✓ Turn the coupling until the digital display reads 10-15 on the % display.
    - ✓ Gently let go of the coupling.
    - ✓ Watch the digital display; you should see a “run” of numbers next to the %; the “run” of numbers should ultimately stop at 0.0 (+/- 0.1).

If the digital display does not return to ZERO, the unit most likely is in need of service.

- Perform calibration check (see Appendix F).
- Contact Brookfield Engineering Laboratories, Inc. or your Brookfield dealer for repair (see Appendix O).

\* This procedure does not apply to instruments with ball bearing suspension (see Section I.3).

#### **□ Display Reading Will Not Stabilize**

- ✓ Special characteristic of sample fluid. There is no problem with the rheometer.
  - Refer to Appendix C.
- ✓ Check for erratic spindle rotation.
  - Verify power supply
  - Contact Brookfield Engineering Laboratories, Inc. or your Brookfield dealer for repair.
- ✓ Bent spindle or spindle coupling.
  - Contact Brookfield Engineering Laboratories, Inc. or your Brookfield dealer for repair.
- ✓ Temperature fluctuation in sample fluid.
  - Use temperature bath for control.

## Appendix M - Instrument Dimensions

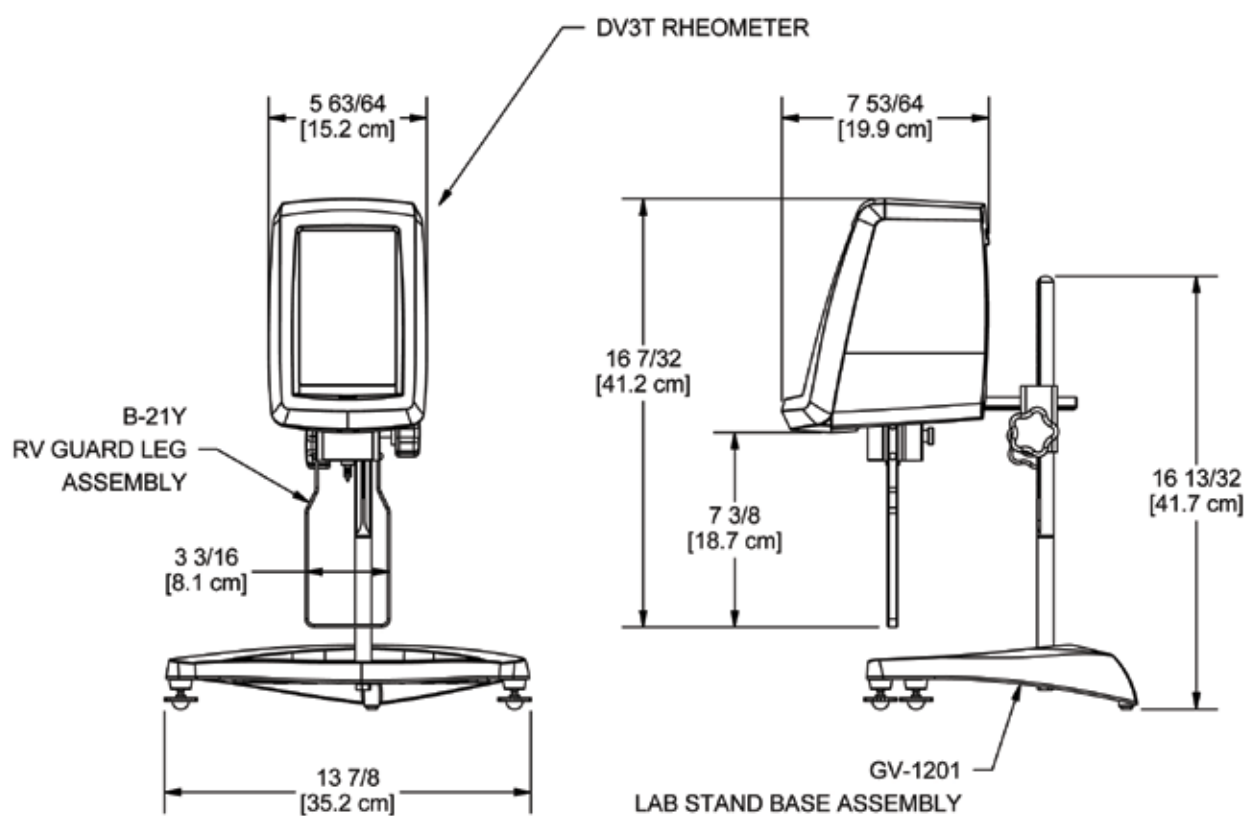
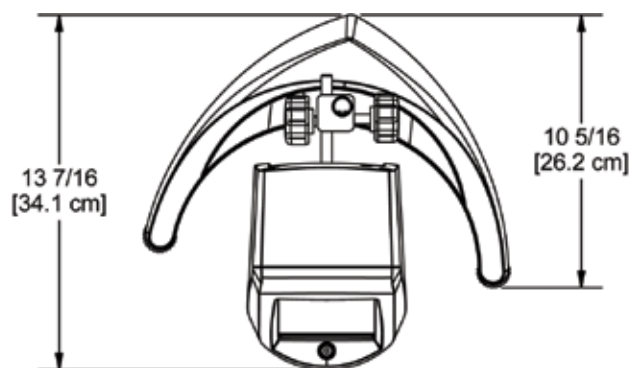

## Appendix N - Online Help and Additional Resources

### **www.brookfieldengineering.com\*\***

The Brookfield website is a good resource for additional and self-help whenever you need it. Our website offers a selection of “how-to” videos, application notes, conversion tables, instructional manuals, material safety data sheets, calibration templates and other technical resources.

### **<http://www.youtube.com/user/BrookfieldEng>**

Brookfield has its own YouTube channel. Videos posted to our website can be found here as well as other “home-made” videos made by our own technical sales group.

### **ViscosityJournal.com**

Brookfield is involved with a satellite website that should be your first stop in viscosity research. This site serves as a library of interviews with experts in the viscosity field as well as Brookfield technical articles and conversion charts. Registration is required, so that you can be notified of upcoming interviews and events, however, this information will not be shared with other vendors, institutions, etc..

### **Article Reprints**

- **Available in Print Only**
- Brookfield has an extensive library of published articles relating to viscosity, texture and powder testing. Due to copyright restrictions, these articles cannot be emailed. Please request your hardcopy of articles by calling our customer service department directly or by emailing: [marketing@brookfieldengineering.com](mailto:marketing@brookfieldengineering.com).
- **Available Online**
- Brookfield has a growing number of published articles that can be downloaded directly from the Brookfield website. These articles can be found on our main site by following this path: [http://www.brookfieldengineering.com/support/documentation/article reprints](http://www.brookfieldengineering.com/support/documentation/article%20reprints).

### **More Solutions to Sticky Problems**

Learn more about viscosity and rheology with our most popular publication. This informative booklet will provide you with measurement techniques, advice and much more. It's a must-have for any Brookfield Viscometer or Rheometer operator. More Solutions is available in print and also as a downloadable PDF on the Brookfield website by following this path: <http://www.brookfieldengineering.com/support/documentation>.

### **Training/Courses**

Whether it is instrument-specific courses, training to help you better prepare for auditing concerns, or just a better understanding of your methods, who better to learn from than the worldwide leaders of viscosity measuring equipment? Visit our Services section on our website to learn more about training.

\*\* Downloads will require you to register your name, company and email address. We respect your privacy and will not share this information outside of Brookfield.

## Appendix O - Warranty Repair and Service

### Warranty

Brookfield Viscometers/Rheometers are guaranteed for one year from date of purchase against defects in materials and workmanship. They are certified against primary viscosity standards traceable to the National Institute of Standards and Technology (N.I.S.T.). The Rheometer must be returned to **Brookfield Engineering Laboratories, Inc.** or to the Brookfield dealer from whom it was purchased for a warranty evaluation. Transportation is at the purchaser's expense. The Rheometer should be shipped in its carrying case together with all spindles originally provided with the instrument. If returning to Brookfield, please contact us for a return authorization number prior to shipping.

All Brookfield DV3T Rheometers are supplied from the factory with a Calibration Seal (located on the back of the viscometer). The warranty stated above will be voided if the Calibration Seal has been damaged. Only Brookfield or our authorized servicing dealer may break the Calibration Seal for purposes of instrument repair or recalibration.

For a copy of the Repair Return Form, go to the Brookfield website,  
[www.brookfieldengineering.com](http://www.brookfieldengineering.com)

For repair or service in the **United States** return to:

Brookfield Engineering Laboratories, Inc.  
11 Commerce Boulevard  
Middleboro, MA 02346 U.S.A.  
Telephone: (508) 946-6200 FAX: (508) 946-6262  
[www.brookfieldengineering.com](http://www.brookfieldengineering.com)

For repair or service outside the United States, consult Brookfield Engineering Laboratories, Inc. or the dealer from whom you purchased the instrument.

For repair or service in the **United Kingdom** return to:

Brookfield Viscometers Limited  
Brookfield Technical Centre  
Stadium Way  
Harlow, Essex CM19 5GX, England  
Telephone: (44) 1279/451774 FAX: (44) 1279/451775  
[www.brookfield.co.uk](http://www.brookfield.co.uk)

For repair or service in **Germany** return to:

Brookfield Engineering Laboratories Vertriebs GmbH  
Hauptstrasse 18  
D-73547 Lorch, Germany  
Telephone: (49) 7172/927100 FAX: (49) 7172/927105  
[www.brookfield-gmbh.de](http://www.brookfield-gmbh.de)

For repair or service in **China** return to:

Guangzhou Brookfield Viscometers and Texture Instruments Service Company Ltd.  
Suite 905, South Tower, Xindacheng Plaza  
193 Guangzhou Da Dao Bei, Yuexiu District  
Guangzhou, 510075 P. R. China  
Telephone: (86) 20/3760-0548 FAX: (86) 20/3760-0548  
[www.brookfield.com.cn](http://www.brookfield.com.cn)

*On-site service at your facility is also available from Brookfield. Please contact our Service Department in the United States, United Kingdom, Germany or China for details.*



This tear-off sheet is a typical example of recorded test data. Please photocopy and retain this template so that additional copies may be made as needed.

<b>VISCOSITY TEST REPORT</b>		DATE:	FOR:
		BY:	
<b>TEST INFORMATION:</b>			
<b>CONCLUSIONS:</b>			