

**BROOKFIELD DV-II+Pro**

**Viscometer**

Operating Instructions

Manual No. **M03-165-F0612**



---

*with offices in:* Boston • Chicago • London • Stuttgart • Guangzhou

**BROOKFIELD ENGINEERING LABORATORIES, INC.**  
11 Commerce Boulevard, Middleboro, MA 02346 USA  
TEL 508-946-6200 or **800-628-8139** (USA excluding MA)  
FAX 508-946-6262 INTERNET <http://www.brookfieldengineering.com>



# Table of Contents

<b>I. INTRODUCTION .....</b>	<b>5</b>
I.1 Components .....	6
I.2 Utilities .....	8
I.3 Specifications.....	8
I.4 Installation .....	9
I.5 Safety Symbols and Precautions.....	10
I.6 Key Functions.....	11
I.7 Cleaning.....	12
<b>II. GETTING STARTED .....</b>	<b>13</b>
II.1 Autozero .....	13
II.2 Spindle Selection.....	14
II.3 Speed Selection, Setting, Running .....	15
II.4 Display Selection.....	17
II.5 Autorange .....	18
II.6 Out of Range .....	19
II.7 Temperature Display .....	20
II.8 Printing .....	20
II.9 External Control Mode.....	21
II.10 Making Viscosity Measurements .....	22
II.11 Time Modes for Viscosity Measurement.....	23
<b>III. MAKING VISCOSITY AND YIELD MEASUREMENTS.....</b>	<b>24</b>
III.1 Quick Start .....	24
III.2 Preparations for Making Measurements .....	24
III.3 Selecting a Spindle/Speed.....	25
III.4 Multiple Data Points .....	25
<b>IV. OPTIONS.....</b>	<b>26</b>
IV.1 Introduction to OPTIONS .....	26
IV.2 Setup.....	28
IV.2.1 Temperature Display .....	29
IV.2.2 Units of Measurement.....	30
IV.2.3 Motor Speed Set Selection .....	30
IV.2.3.1 LV/RV Speeds .....	31
IV.2.3.2 Custom Speeds.....	31
IV.2.4 Printer Output Port .....	31
IV.2.5 Data Averaging.....	32
IV.3 Time Modes.....	33
IV.3.1 Time to Stop .....	33
IV.3.2 Time to Torque .....	36
IV.3.3 Print Time Interval .....	38
IV.3.4 PC Program (On/Off).....	39

IV.3.5	Download a Program.....	40
IV.3.6	Run a Program.....	41
<b>V.</b>	<b>DVLOADER SOFTWARE.....</b>	<b>43</b>
V.1	B.E.V.I.S. Overview .....	43
V.2	Description of B.E.V.I.S. Commands.....	43
V.3	Creating a B.E.V.I.S. Program.....	44
V.4	Downloading a B.E.V.I.S. Program.....	46
V.5	Example Programs.....	47
<b>VI.</b>	<b>AUTOMATED DATA GATHERING &amp; ANALYSIS.....</b>	<b>49</b>
V1.1	WINGATHER.....	49
V1.2	Rheocalc.....	53
V1.3	Math Models .....	56
V1.3.1	The Power Law (Ostwald) Model.....	57
V1.3.2	The Herschel-Bulkley Model.....	58
V1.3.3	The Bingham Model .....	60
V1.3.4	The Casson Model.....	61
V1.3.5	Other Common Rheological Models .....	63
<b>Appendix A</b>	<b>- Cone/Plate Viscometer Set-Up.....</b>	<b>65</b>
<b>Appendix B</b>	<b>- Viscosity Ranges .....</b>	<b>69</b>
<b>Appendix C</b>	<b>- Variables in Viscosity Measurements.....</b>	<b>74</b>
<b>Appendix D</b>	<b>- Spindle and Model Codes .....</b>	<b>76</b>
<b>Appendix E</b>	<b>- Calibration Procedures .....</b>	<b>79</b>
<b>Appendix F</b>	<b>- The Brookfield Guardleg.....</b>	<b>86</b>
<b>Appendix G</b>	<b>- Speed Sets.....</b>	<b>88</b>
<b>Appendix H</b>	<b>- Communications .....</b>	<b>89</b>
<b>Appendix I</b>	<b>- Model S Laboratory Stands.....</b>	<b>91</b>
<b>Appendix J</b>	<b>- DVE-50A Probe Clip.....</b>	<b>93</b>
<b>Appendix K</b>	<b>-Fault Diagnosis and Troubleshooting.....</b>	<b>94</b>
<b>Appendix L</b>	<b>- Instrument Dimensions.....</b>	<b>98</b>
<b>Appendix M</b>	<b>- Online Help and Additinal Resources.....</b>	<b>99</b>
<b>Appendix N</b>	<b>- Warranty Repair and Service .....</b>	<b>100</b>
<b>Viscosity Test Report</b>	.....	Tear out page

## I. INTRODUCTION

The Brookfield DV-II+Pro Viscometer measures fluid viscosity at given shear rates. Viscosity is a measure of a fluid's resistance to flow. You will find a detailed description of the science of viscosity in the Brookfield publication "*More Solutions to Sticky Problems*" a copy of which was included with your DV-II+Pro.

The DV-II+Pro offers exceptional versatility in modes of control allowing for traditional standalone operation, automatic operation through programs downloaded from the PC or with complete control by PC using Brookfield Rheocalc Software.

- The DV-II+Pro can be used as a traditional Brookfield viscometer for collection of single speed viscosity data through the easy to use keypad; just select the spindle and speed and read the value from the display. **[See Section II, Getting Started]**
- The Brookfield DVLoader Software can be used to program the DV-II+Pro to control all aspects of the test and data collection without the need for the operator to monitor the instrument; just start the program and return to the printed test data (printer is optional). **[See Section V, DVLoader Software]**
- The Brookfield Rheocalc Software will perform all control and data collection functions of the DV-II+Pro from the PC while also providing a platform for advanced data collection and analysis. **[See Section II.9, External Control]**

In any of these modes of control, the DV-II+Pro will provide the best in viscosity measurement and control.

The principal of operation of the DV-II+Pro is to drive a spindle (which is immersed in the test fluid) through a calibrated spring. The viscous drag of the fluid against the spindle is measured by the spring deflection. Spring deflection is measured with a rotary transducer. The measurement range of a DV-II+Pro (in centipoise or milliPascal seconds) is determined by the rotational speed of the spindle, the size and shape of the spindle, the container the spindle is rotating in, and the full scale torque of the calibrated spring.

There are four basic spring torque series offered by Brookfield:

<u>Model</u>	<u>Spring Torque</u>	
	<u>dyne/cm</u>	<u>milli Newton/m</u>
LVDV-II+Pro	673.7	0.0673
RVDV-II+Pro	7,187.0	0.7187
HADV-II+Pro	14,374.0	1.4374
HBDV-II+Pro	57,496.0	5.7496

The higher the torque calibration, the higher the measurement range. The measurement range for each torque calibration may be found in Appendix B.

**All units of measurement are displayed according to either the CGS system or the SI system.**

1. Viscosity appears in units of centipoise (shown as "cP") or milliPascal-seconds (shown as "mPa•s") on the DV-II+Pro Viscometer display.
2. Shear Stress appears in units of dynes/square centimeter ("D/cm<sup>2</sup>") or Newtons/square meter ("N/m<sup>2</sup>").
3. Shear Rate appears in units of reciprocal seconds ("1/SEC").
4. Torque appears in units of dyne-centimeters or Newton-meters (shown as percent "%" in both cases) on the DV-II+Pro Viscometer display.

**Note:** To change CGS to SI units on the display - see Section IV.2.2.

The equivalent units of measurement in the SI system are calculated using the following conversions:

	<u>SI</u>	=	<u>CGS</u>
Viscosity:	1 mPa•s	=	1 cP
Shear Stress:	1 Newton/m <sup>2</sup>	=	10 dyne/cm <sup>2</sup>
Torque:	1 Newton/m	=	10 <sup>7</sup> dyne/cm

References to viscosity throughout this manual are done in CGS units. The DV-II+Pro Viscometer provides equivalent information in SI units.

## I.1 Components

Please check to be sure that you have received all components, and that there is no damage. If you are missing any parts, please notify Brookfield Engineering or your local Brookfield agent immediately. Any shipping damage must be reported to the carrier.

Component	Part Number	Quantity
DV-II+Pro Viscometer	varies	1
Model S Laboratory Stand	MODEL S	1
Spindle Set with Case	varies	1
<b>LV</b> DV-II+Pro set of four spindles	SSL	or
<b>RV</b> DV-II+Pro set of six spindles (#2 - #7)	SSR	or
<b>HA/HBDV</b> -II+Pro set of six spindles (#2 - #7)	SSH	
<b><i>For Cone/Plate versions: a spindle wrench (CP-23), one cone spindle (CPE-XX or CPA-XX), a sample cup, and Part No. CPE-44Y replaces the spindle set.</i></b>		
Power Cord		1
DVP-65 for 115 or	DVP-65	
DVP-66 for 230	DVP-66	
RTD Temperature Probe	DVP-94Y	1
Guard Leg:		1
<b>LV</b> DV-II+Pro	B-20Y	
<b>RV</b> DV-II+Pro	B-21Y	
Carrying Case	DVE-7Y	1
DVLOADER CD ROM	DVLOADER	1
Cable (DV-II+Pro to computer) (RS-232)	DVP-80	1
Operating Manual	M03-165	1
Shipping Cap	XXX	1

# COMPONENT DIAGRAM

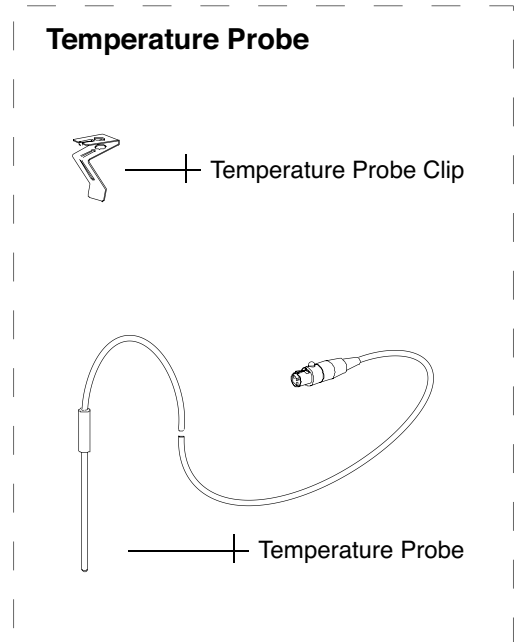
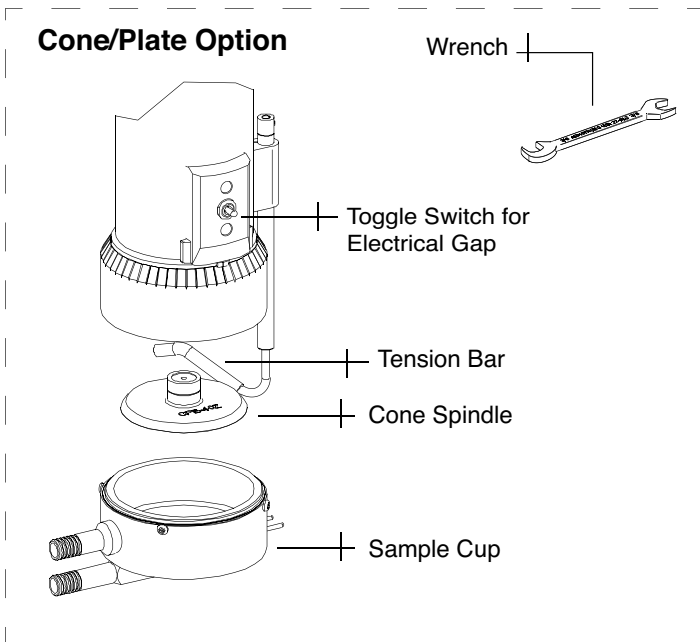
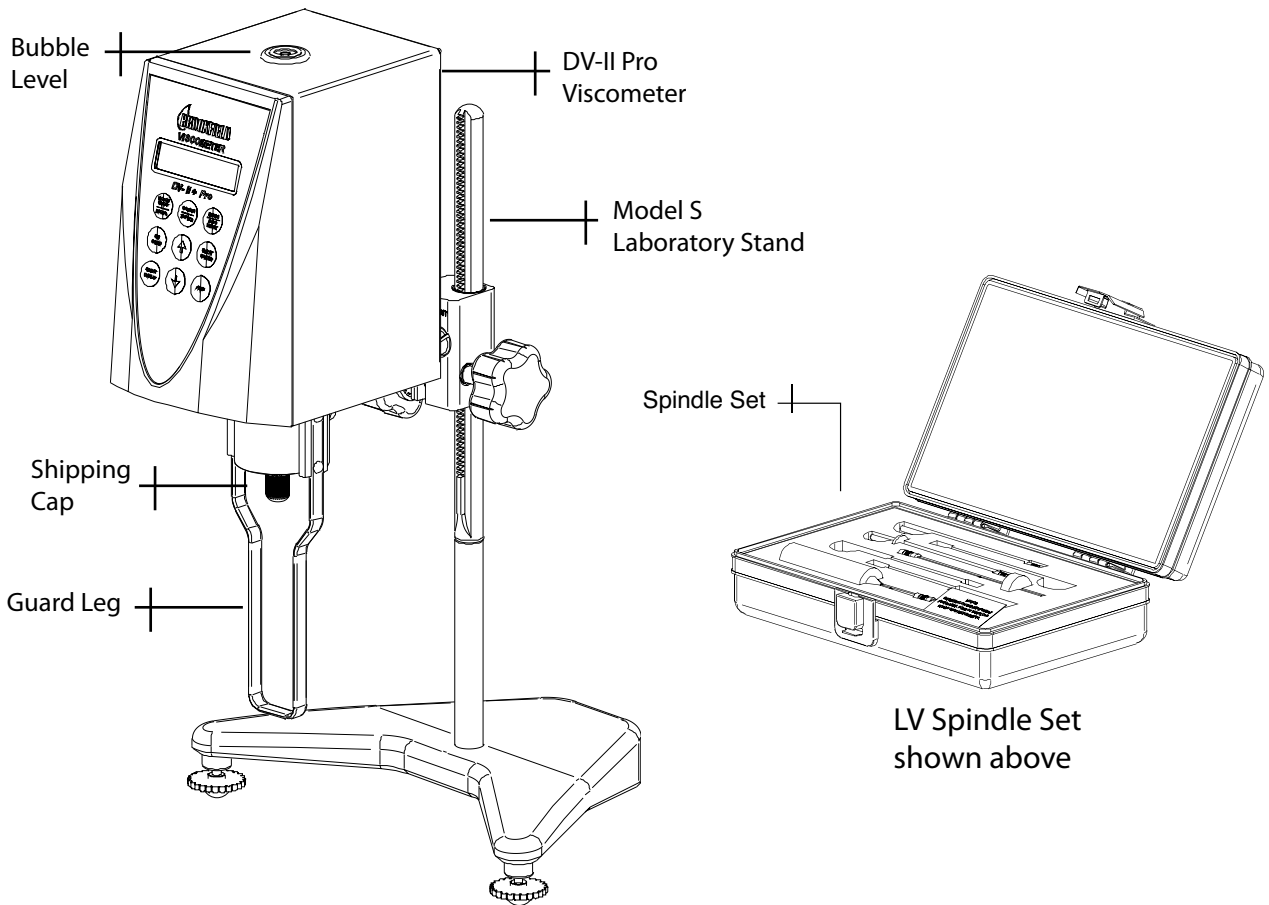

## I.2 Utilities

Input Voltage: 115 VAC or 230 VAC  
Input Frequency: 50/60 Hz  
Power Consumption: 30 VA  
Power Cord Color Code:

	<b>United States</b>	<b>Outside United States</b>
Hot (live)	Black	Brown
Neutral	White	Blue
Ground (earth)	Green	Green/Yellow



Main supply voltage fluctuations are not to exceed  $\pm 10\%$  of the nominal supply voltage.

## I.3 Specifications

**Speeds:** Choice of 3 options.  
Instrument has “Interleaved” speeds when manufactured.

Standalone

Interleaved:	LV/RV (18 speeds) 8 LV speeds followed by 10 RV speeds
Sequential:	LV/RV (18 speeds) 8 LV speeds and 10 RV speeds arranged in sequential order from lowest 0.3 rpm to highest 100 rpm.
Custom:	54 speeds, user selectable

External (PC Control) 0.01 - 200 rpm  
0.01 rpm increments from 0.01 to 0.99 rpm  
0.1 rpm increments from 1.0 to 200 rpm

**Note:** Refer to Appendix G for detailed list of all speeds.

<b>Weight:</b>	Gross Weight	23 lbs.	10.5 kg.
	Net Weight	20 lbs.	9 kg.
	Carton Volume	1.65 cu. ft.	0.05 m <sup>3</sup>
	Carton Dimensions	22 in. (56 cm) W x 11 in. (28 cm) L x 22 in. (56 cm) H	

**Temperature Sensing Range:** -100°C to 300°C (-148°F to 572°F)

**Analog Torque Output:** 0 - 1 Volt DC (0 - 100% Torque)

**Analog Temperature Output:** 0 - 3.75 Volts DC (-100°C to +275°C)

**RS232 Compatible Serial Port for use with an attached printer or PC.**

**Centronics Compatible Parallel Port for use with an attached printer.**

**Viscosity Accuracy:**  $\pm 1.0\%$  of full scale range  
The use of accessory items will have an effect on the measurement accuracy. See Appendix B.

**Viscosity Repeatability:**  $\pm 0.2\%$  of Full Scale Range



**Temperature Accuracy:**             $\pm 1^{\circ}\text{C}$  |  $-100^{\circ}\text{C}$  to  $+149^{\circ}\text{C}$   
    $\pm 2^{\circ}\text{C}$  |  $+150^{\circ}\text{C}$  to  $+300^{\circ}\text{C}$

**Operating Environment:**             $0^{\circ}\text{C}$  to  $40^{\circ}\text{C}$  temperature range ( $32^{\circ}\text{F}$  to  $104^{\circ}\text{F}$ )  
   20% - 80%R.H.: non-condensing atmosphere

**Ball Bearing Option:**

If you ordered the ball bearing suspension system with your new instrument please note the following:

- 1) The ball bearing suspension in your Brookfield instrument is noted on the serial tag on the back of the head by the letter “B” after the model.
- 2) When attaching and detaching the spindle, it is not necessary to lift the coupling where the spindle connects to the instrument.
- 3) The Oscillation Check explained in Appendix K, Fault Diagnosis and Troubleshooting, does not pertain to this instrument.

**Electrical Certifications:**

Conforms to CE Standards:

- BSEN 61326:            Electrical equipment for measurement, control and laboratory use - EMC requirements
- BSEN 61010-1:        Safety requirements for electrical equipment, for measurement, control and laboratory use

**Notice to customers:**



This symbol indicates that this product is to be recycled at an appropriate collection center.

**Users within the European Union:**

Please contact your dealer or the local authorities in charge of waste management on how to dispose of this product properly. All Brookfield offices and our network of representatives and dealers can be found on our website: [www.brookfieldengineering.com](http://www.brookfieldengineering.com)

**Users outside of the European Union:**

Please dispose of this product according to your local laws.

## I.4 Installation

*Note:* “IQ, OQ, PQ”, a guideline document for installation, operation and performance validation for your DV-II+Pro digital viscometer can be downloaded from our web site [www.brookfieldengineering.com](http://www.brookfieldengineering.com).

- 1) Assemble the Model S Laboratory Stand (refer to assembly instructions in Appendix I).
- 2) Put the viscometer on the stand.

- 3) Connect the RTD probe to the socket on the rear panel of the DV-II+Pro.
- 4) The Viscometer must be leveled. The level is adjusted using the two leveling screws on the base. Adjust so that the bubble level on top of the DV-II+Pro is centered within the circle.

*Note:* Check level periodically during use.

- 5) Remove the shipping cap which secures the coupling nut on the Viscometer to the pivot cup. For Cone/Plate Models, hold the Sample Cup and swing the tension bar away from the bottom of the cup. Lower the cup and remove the foam insert. (Save for future shipments.)
- 6) Make sure that the AC power switch at the rear of the DV-II+Pro is in the OFF position. Connect the power cord to the socket on the back panel of the instrument and plug it into the appropriate AC line. For Cone/Plate Models, be sure that the toggle switch, used to set the electrical gap, is to the left position. (Left when facing the viscometer keypad.)



The AC input voltage and frequency must be within the appropriate range as shown on the nameplate of the viscometer. (See section I.2.)



*Note:* The DV-II+Pro must be earth grounded to ensure against electronic failure!!

- 7) Turn the power switch to the ON position and allow the viscometer to warm up for 10 minutes before performing autozero.
- 8) For Cone/Plate models, refer to Appendix A.
- 9) If appropriate, connect interconnecting cable (DVP-80) to serial port for connection of DV-II+Pro to PC or printer.
- 10) If appropriate, connect interconnecting cable to parallel port for connection of DV-II+Pro to printer.
- 11) If appropriate, connect interconnecting cable (DVP-96Y) to analog (serial) port for connection of DV-II+Pro to chart recorder.

## I.5 Safety Symbols and Precautions

### Safety Symbols

The following explains safety symbols which may be found in this operating manual.



Indicates hazardous voltages may be present.



Refer to the manual for specific warning or caution information to avoid personal injury or damage to the instrument.

### Precautions



If this instrument is used in a manner not specified by the manufacturer, the protection provided by the instrument may be impaired.



This instrument is not intended for use in a potentially hazardous environment.



In case of emergency, turn off the instrument and then disconnect the electrical cord from the wall outlet.



The user should ensure that the substances placed under test do not release poisonous, toxic or flammable gases at the temperatures which they are subjected to during the testing.

## I.6 Key Functions

Figure I-1 shows the control keys on the face of the DV-II+Pro Viscometer. The following describes the function of each key.

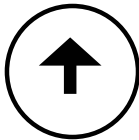

### UP ARROW

This key is used to scroll UP (in an increasing value direction) through the available speed, spindle and Option menu tables.

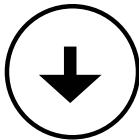

### DOWN ARROW

This key is used to scroll DOWN (in a decreasing value direction) through the available speed, spindle and option menu tables.



### MOTOR ON/OFF/ESCAPE

**MOTOR ON/OFF:** Turns the motor ON or OFF.

**ESCAPE:** Exits the *Options* menu.

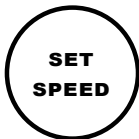

### SET SPEED

Causes the DV-II+Pro to begin running at the currently selected speed. This function works only when the motor is ON. Also used to select custom speeds when in the *Custom Speed* option.

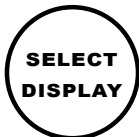

### SELECT DISPLAY

Selects the data parameter to be displayed:

**cP** Viscosity (cP or mPa·s)  
**SS** Shear Stress (dynes/cm<sup>2</sup> or Newtons/m<sup>2</sup>)  
**SR** Shear Rate (1/sec)



### ENTER/AUTO RANGE

**ENTER:** Used to execute the currently flashing option.

**AUTO RANGE:** Presents the maximum (100% torque) viscosity attainable using the selected spindle at the current viscometer spindle speed.

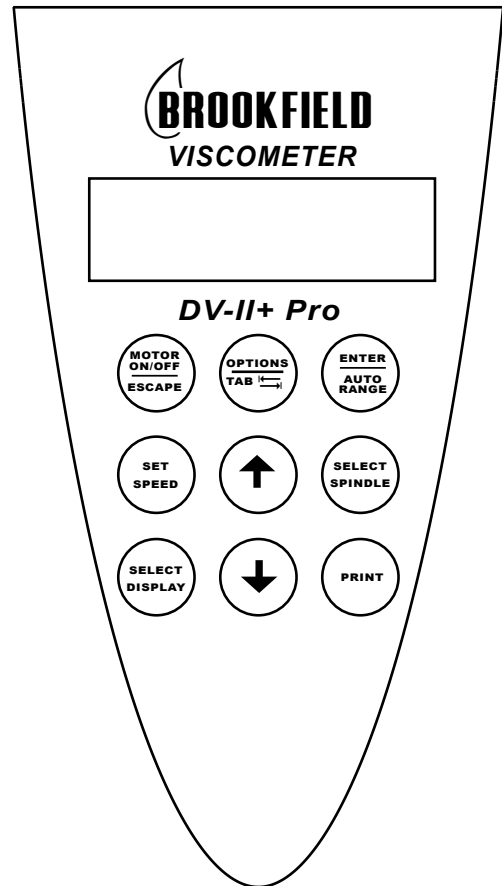

Figure I-1



**SELECT SPINDLE**

Initiates spindle selection on the first press and then selects the currently scrolled-to spindle when pressed a second time.



**PRINT**

Selects printing and non-printing modes when a printer is attached.



**OPTIONS/TAB**

**OPTIONS:** Presents the *Options* menu, flashing the last escaped option.

**TAB:** Toggles between selectable items when indicated, as shown in Figure I-2.

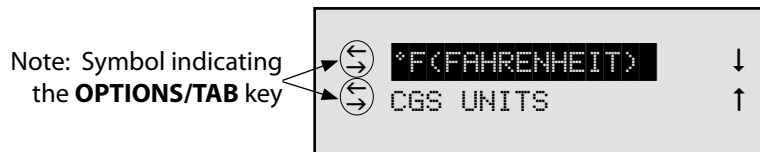

*Figure I-2*

*Note:* Inverted text (black background with white lettering) indicates that the information is flashing on the viscometer display.

**I.7 Cleaning**

- Make sure the instrument is in a decent working environment (dust-free, moderate temperature, low humidity, etc.).
- Make sure the instrument is on a level surface.
- Hands/fingers must be clean and free of residue sample. Not doing so may result in deposit build up on the upper part of the shaft and cause interference between the shaft and the pivot cup.
- Be sure to remove the spindle from the instrument prior to cleaning. Note left-handed thread. Severe instrument damage may result if the spindle is cleaned in place.

Instrument and Keypad: Clean with a dry, non-abrasive cloth. Do not use solvents or cleaners.

Immersed Components (spindles): Spindles are made of stainless steel. Clean with a non-abrasive cloth and solvent appropriate for sample material.

- When cleaning, do not apply excessive force, which may result in bending spindles.

## II. GETTING STARTED

### II.1 Autozero

Before readings may be taken, the Viscometer must be Autozeroed. This action is performed each time the power switch is turned on. (Note: If cable DVP-80 is connected for printer or computer communication see section II.9). The display window on the Viscometer will guide you through the procedure as follows:

Turn the power switch (located on the rear panel) to the **ON** position. This will result in the screen display shown in Figure II-1 indicating that the DV-II+Pro viscometer is in the standalone mode (is not connected to a computer).

```
BROOKFIELD      DV-2+
PRO              VISCOMETER
```

*Figure II-1*

After a few seconds, the following screen appears indicating the version of the operating firmware (the built in program which controls the instrument) and an alphanumeric code, which indicates the Model number (see Table D-2 in Appendix D; the code indicates the spring torque rating or the viscosity measurement range of your viscometer). For most DV-II+Pro Viscometers, this information will be either “LV”, “RV” or “HB”:

```
BROOKFIELD      DV-2+
RV              U6.3
```

*Figure II-2*

No key press is required at this point. After a short time, the display will clear and the following will be displayed:

```
REMOVE SPINDLE
PRESS ANY KEY
```

*Figure II-3*

After removing the spindle and pressing any key, the **DV-II+Pro** begins its Autozero. The screen will flash “Autozeroing.”

After approximately 15 seconds, the display shows the screen in **Figure II-4**:

```
REPLACE SPINDLE
PRESS ANY KEY
```

*Figure II-4*

Pressing any key at this point results in the display of the **DV-II+Pro** default screen:

```
CP 0.0          20.1C
OFFRPM          % 0.0
```

*Figure II-5*

The display will vary depending upon the selection of temperature (°F or °C) and units of viscosity (cP or mPa•s).

## II.2 Spindle Selection

LVDV-II+Pro Viscometers are provided with a set of four spindles and a narrow guardleg; RVDV-II+Pro Viscometers come with a set of six spindles and a wider guardleg; HADV-II+Pro and HBDV-II+Pro Viscometers come with a set of six spindles and **no guardleg**. (See Appendix F for more information on the guardleg.)

The spindles are attached to the viscometer by screwing them onto the coupling nut on the lower shaft, see Figure II-6. Note that the spindles have a left-hand thread. The lower shaft should be secured and slightly lifted with one hand while screwing the spindle to the left. The face of the spindle nut and the matching surface on the lower shaft should be smooth and clean to prevent eccentric rotation of the spindle. Spindles can be identified by the number on the side of the spindle coupling nut.

 The motor should be OFF whenever spindles are being removed or attached.

If your instrument has the EZ-Lock system, the spindles are attached as follows:

With one hand hold the spindle, while gently raising the spring-loaded outer sleeve to its highest position with the other hand, as shown in Figure II-7. Insert the EZ-Lock Spindle Coupling so that the bottom of the coupling is flush with the bottom of the shaft, and lower the sleeve. The sleeve should easily slide back down to hold the spindle/coupling assembly in place for use. [Spindles can be identified by entry code; look for the number on the side of the EZ-Lock spindle coupling.]

 The motor should be OFF whenever spindles are being removed or attached.

*Note:*  Keep the EZ-Lock Spindle Coupling and outer sleeve as clean as possible and free from debris that could become lodged inside the adapter.

The DV-II+Pro must have a Spindle Entry Code number to calculate Viscosity, Shear Rate and Shear Stress values. The DV-II+Pro memory contains parameters for all standard Brookfield spindles including custom spindles and the two digit entry code for each spindle (the complete list of entry codes may be found in Appendix D).

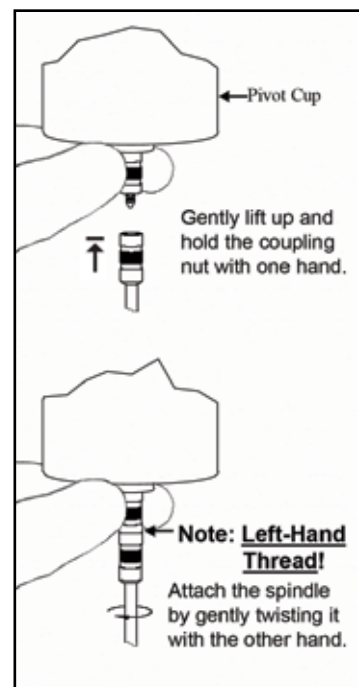

Figure II-6

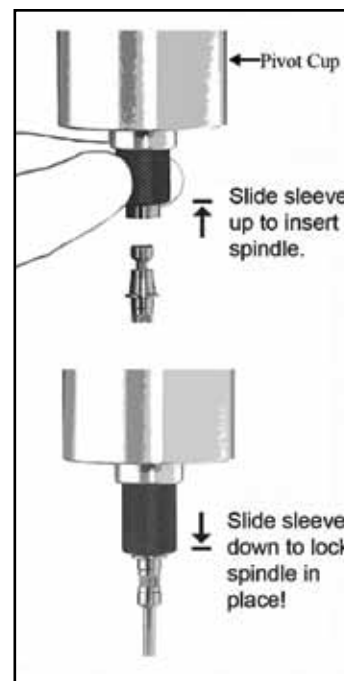

Figure II-7

*Note:* The DV-II+Pro will remember the Spindle Entry Code which was in use when the power was turned off.

Pressing the SELECT SPINDLE key will temporarily display the current selected spindle code in place of temperature and cause the character **S** to begin to blink. It will blink for about three seconds. If the UP or DOWN ARROW keys are pressed (while **S** is blinking), the two character spindle value to the right of the **S** character will begin to change (in either an increasing or decreasing direction depending upon which ARROW key is pressed) for each press of the key. If the ARROW key is pressed and held, the display will scroll through the spindle codes for as long as the ARROW key is depressed. When it reaches the last item in the list (either at the top or bottom of the list) the spindle code displayed will “roll-over” to either the first or last spindle code and the scroll action will continue.

When the desired spindle code is displayed, release the ARROW key to halt further scrolling. Press the SELECT SPINDLE key once again. This will cause the **S** character to cease blinking and the new spindle code will be accepted for use in viscometer calculations. After 3 seconds the current spindle code will be replaced by the temperature display.

*Note:* You have approximately three seconds in which to press the SELECT SPINDLE key before the *blinking* stops. If you fail to press the SELECT SPINDLE key before the *blinking* stops you will have to repeat the above steps and re-select the desired spindle.

The DV-II+Pro will begin to calculate using the new spindle parameters as soon as the SELECT SPINDLE key is pressed the second time.

*Note:* The number 99 spindle is for use with special spindles when using Brookfield’s Rheocalc computer program. Refer to the Rheocalc operator manual for further information on using “99” spindles.

The DV-II+Pro may also be programmed at Brookfield Engineering for “special” user spindles. These “special” spindles will appear on the spindle scroll list starting with designation “AA” and continuing through “AZ”. Contact Brookfield Engineering regarding your needs for special spindles.

### II.3 Speed Selection, Setting, Running

There are 54 speeds programmed into the DV-II+Pro. These speeds correspond to the standard LVT, RVT, HAT and HBT dial models (18 possible speeds altogether) plus 36 additional speeds.

The DV-II+Pro comes with the Sequential Speed Set already selected (see Appendix G). The speed set will start at speed 0.0. It will then scroll up through the LV speeds, pass through speed 0.0 again, and then scroll up through the RV speeds, pass through speed 0.0 again and then repeat the above sequence.

The DV-II+Pro can also be configured by the operator to interleave the LV and RV speeds. See Section IV.2.3 on Setup for a description of how to install the Interleave Speed Set.

A complete list of speed sets and custom speeds is included in Appendix G. The DV-II+Pro can be programmed to select up to 19 of the 54 speeds for use at any one time. Speed 0.0 is automatically included as one of the nineteen (19) speeds. See Section IV. 2.3.2 on Setup for a description of

how to install a Custom Speed Set.

To select a Viscometer speed first press either the UP or DOWN arrow keys which will cause the area to the right of RPM to display the currently selected speed. Figure II-8 shows the DV-II+Pro is operating at 6.0 RPM, and the current selected speed is 6.0 RPM.

*Caution:* If you select custom speeds but do not choose any speed values, only zero RPM will be available in the scroll list.

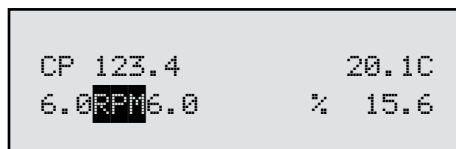

```
CP 123.4          20.1C
6.0RPM6.0        % 15.6
```

*Figure II-8*

If the ARROW key is pressed just once and then released, the characters “RPM” will blink for three seconds, then will cease blinking resulting in no change to the speed entry.

*Note:* The speed selection process remembers the last value of scrolled-to speed so that the next time you initiate a speed change (by pressing an ARROW key), the DV-II+Pro will begin its scroll display from the last entered value.

The last-scrolled-to speed does not necessarily have to be the same as the speed at which the DV-II+Pro is currently running. The user may operate at a given speed and pre-set the DV-II+Pro to the next desired speed before that speed will be used. For example, if the DV-II+Pro is currently running at 6.0 RPM and was previously scrolled to 12 RPM, a single press of either ARROW key would result in the Figure II-9 screen display:

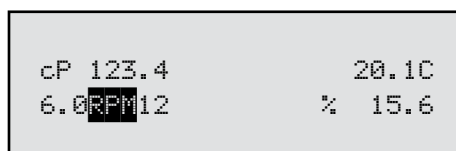

```
CP 123.4          20.1C
6.0RPM12         % 15.6
```

*Figure II-9*

Pressing the SET SPEED key would cause the DV-II+Pro to begin running at 12 RPM.

If the user did not press the SET SPEED key, the DV-II+Pro would continue to run at its current speed of 6 RPM. In fact, you may scroll to a new speed (12 RPM in this example) and press the SET SPEED key at any future time (without further pressing an ARROW key) to immediately cause the DV-II+Pro to run at the new speed. Pressing the ARROW key at any time reminds the operator of what was selected for the next speed.

If an ARROW key is pressed and held the DV-II+Pro will scroll up (or down) through the speed table. When it reaches the last speed in the list (either at the top or bottom of the list) the speed displayed will “roll-over” to either the first or last speed in the table and the scroll action will continue.

When the required speed is displayed, release the ARROW key to halt further scrolling. The selected speed will be visible for approximately two seconds. Press the SET SPEED key to immediately begin rotation at the new speed.

Pressing the MOTOR ON/OFF/ESCAPE key stops the Viscometer spindle rotation. Pressing this key sets the DV-II+Pro to 0.0 RPM and causes the screen display to change as shown in Figure II-10:



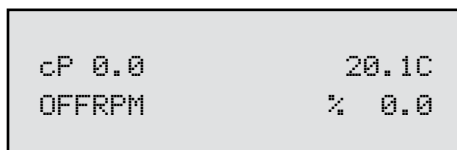

**Figure II-10**

Pressing the MOTOR ON/OFF/ESCAPE key again immediately starts the DV-II+Pro running at the last scrolled-to-speed. If you had been running at 12 RPM, pressed MOTOR ON/OFF/ESCAPE and then re-started the DV-II+Pro by pressing MOTOR ON/OFF/ESCAPE once again, you would again be running at 12 RPM. However, if while the motor was off you had scrolled to a new speed of 0.5 RPM, pressing the MOTOR ON/OFF/ESCAPE key would start the DV-II+Pro running at 0.5 RPM.

*Note:* During both spindle or speed selection and scrolling operations, the DV-II+Pro will continue to calculate and display Viscometer data as selected.

## II.4



## Display Selection

*Viscosity* (displayed in units of cP or mPa•s), *Shear Stress* and *Shear Rate* are displayed on the left side of the top line. You may “step” through the three display options by pressing the SELECT DISPLAY key. For example, the DV-II+Pro is currently displaying *Viscosity* in Figure II-11:

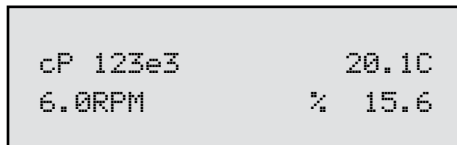

**Figure II-11**

If the viscosity value exceeds 99,999 scientific notation is used. In Figure II-10, the viscosity value is 123,000 cP.

The first press of the SELECT DISPLAY key would display Shear Stress (SS) in Dynes/cm<sup>2</sup> (or Newtons/m<sup>2</sup>), see Figure II-12:

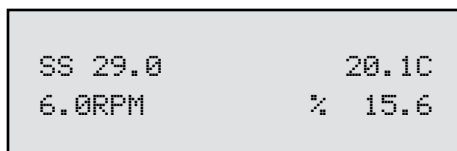

**Figure II-12**

If the shear stress value exceeds 99,999, scientific notation is used.

The next press of the SELECT DISPLAY key would display Shear Rate (SR) in 1/Sec (Figure II-13).

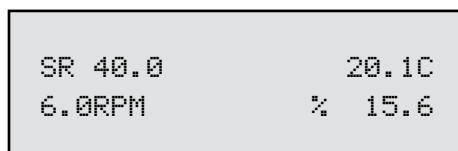

Figure II-13

One more press of the SELECT DISPLAY key would result in a return to the viscosity screen, as shown in Figure II-11.

*Note:*

1. You may step through the display at any time. This will not interrupt any Viscometer calculations that are in progress.
2. Display of shear rate and shear stress requires selection of appropriate spindles. Otherwise, values displayed will be zero (0). Refer to Appendix D.

Shear rate and shear stress values will be displayed for any spindle with a SRC value greater than zero.

### Units of Measurement

The DV-II+Pro Viscometer can be configured using the SETUP option (Section IV.2.2) to display/print in either the CGS or SI system of units.

## II.5



### Autorange

The ENTER/AUTO RANGE key functions as Auto Range and allows you to determine the maximum calculated viscosity (full scale reading) possible with the current spindle/speed setting only when in the default screen. Pressing the key *at any time* will cause the current viscosity display to change and show that *maximum* viscosity. The screen area displaying % (torque) will now display a flashing “%100.0” to indicate this special condition. This maximum viscosity and flashing %100.0 value will be displayed for as long as the ENTER/AUTO RANGE key is depressed. Figure II-14 shows the AUTO RANGE function for the situation where the No. 1 LV spindle is rotating at 60 rpm. The full scale range is 100.0 cP (or 100.0 mPa·s).

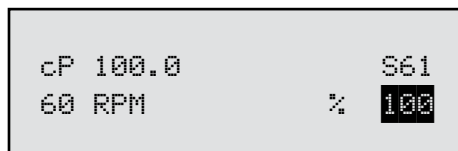

Figure II-14

*Note:*

1. If the RPM is 0.0, the maximum viscosity displayed will be 0.0 cP (or 0.0 mPa·s).
2. While the Viscometer is in the Auto Range mode, any data sent to an attached printer or computer reflects the displayed values (i.e. Auto Range values).
3. This function is only available when in the default screen.
4. If the motor is Off, Auto Range is not available.

## II.6 Out of Range

The DV-II+Pro gives indications for out-of-range operation. When % (Torque) readings exceed 100% (over-range), the display changes to that shown in Figure II-15; EEEE will also appear in the display for shear stress:

```

cP EEEE          20.1C
10 RPM          % EEEE
  
```

Figure II-15

You must change either speed or spindle to correct this condition. If you operate at spindle speeds that produce % (Torque) below 10.0 %, the DV-II+Pro flashes the % (Torque), cP (Viscosity), SS (Shear Stress) and SR (Shear Rate) as shown in Figure II-16:

```

cP 12.4          20.1C
10 RPM          % 8.2
  
```

Figure II-16

Negative % (Torque) will be displayed as shown in Figure II-17:

```

cP ----          20.1C
10 RPM          % -2.2
  
```

Figure II-17

Figure II-18 is an example of the printed output of each of the above conditions.

<b>Normal Operation:</b>							
RPM=50	M=RV	S=29	%=51.4	cP=10280	D/CM2=1285	1/SEC=12.3	T=20.1C Z00:30
<b>Over-Range Operation (&gt;100% torque) (see Fig. 15):</b>							
RPM=50	M=RV	S=29	%=EEEE	cP=EEEE	D/CM2=EEEE	1/SEC=12.3	T=20.1C Z00:30
<b>Under-Range Operation (&lt;10% torque) (see Fig. 16):</b>							
? RPM=50	M=RV	S=29	%=5.2	cP=1040	D/CM2=130	1/SEC=12.3	T=20.1C Z00:30
<b>Negative Torque Operation (see Fig. 17):</b>							
RPM=50	M=RV	S=29	%=-0.1	cP=-----	D/CM2=-----	1/SEC=12.3	T=20.1C Z00:30

M = Torque Range

T = Temperature

Z = Time

Figure II-18

## II.7 Temperature Display

The DV-II+Pro displays the measured temperature when an RTD temperature probe is connected. Temperature may be displayed in either °C (Centigrade) or °F (Fahrenheit) units, depending upon selection from the Options menu. As received, the default temperature display will be in °C (Centigrade) as shown in the Figure II-19:

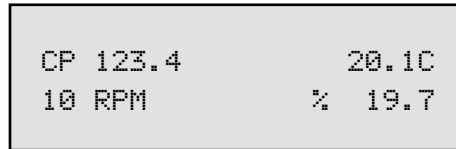

Figure II-19

If you turn on the DV-II+Pro with the temperature probe disconnected, or remove the temperature probe at any point after power-up, the display will indicate “- - - -C”. The four “dashes” indicate the absence of the probe. If you were displaying temperature in Fahrenheit units, the C would be replaced by an F. Accuracy of temperature measurement for the DV-II+Pro is shown in Table 1.

Table 1

Temperature Accuracies for DV-II+Pro Viscometer	
Temperature Range	Temperature Accuracy
-100°C to +149°C	±1.0°C
+150°C to +300°C	±2.0°C

*Note:* The temperature probe may be connected/disconnected at any time.

## II.8 Printing

The DV-II+Pro will print data to an attached Serial (RS232) or Parallel (centronics) printer. The printer must be attached to the appropriate rear panel output connector. See Appendix H for configuration and connection requirements.

Data may be printed in two ways:

1. Pressing the PRINT key once (for less than three (3) seconds) will result in the printing of one standard print line.
2. If the PRINT key is pressed and held for more than three (3) seconds, the DV-II+Pro will then begin *continuous* printer output at a print rate interval selected via the Options menu (see Section IV.3.3). The display will show a flashing P in front of the % sign. See Figure II-20.

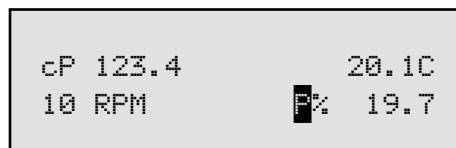

Figure II-20

To stop continuous printing, press the PRINT key for one (1) second. The flashing P will disappear on the viscometer display.

Figure II-21 is an example of the print strings for CGS and SI units.

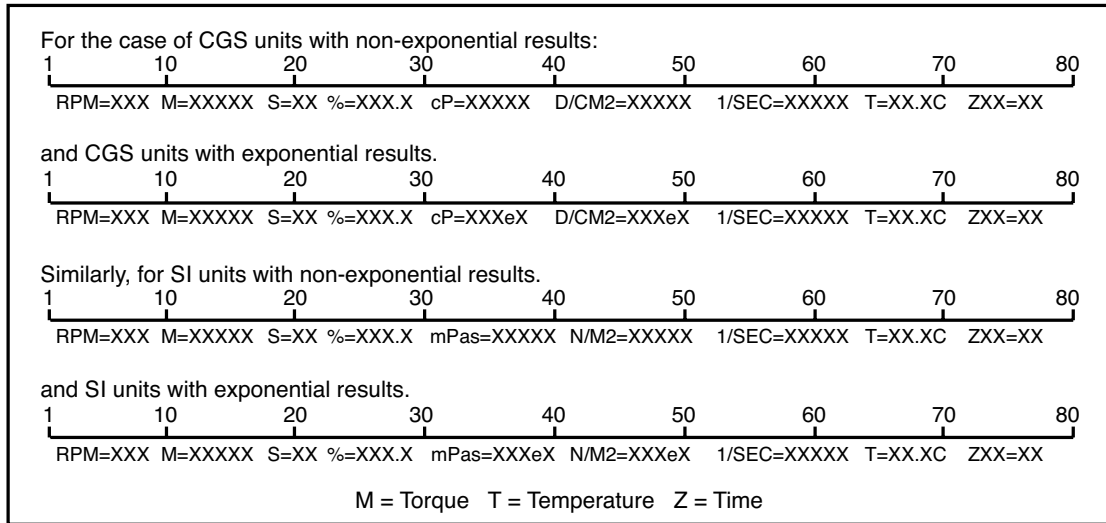

Figure II-21

When printing via the parallel port, please note that if a printer is not attached to the viscometer, the following screen appears:

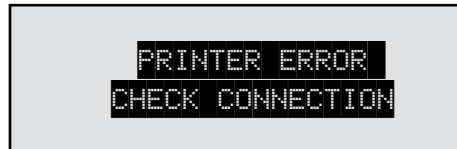

Figure II-22

## II.9 External Control Mode

The DV-II+Pro Viscometer can be used in conjunction with Brookfield software, Rheocalc (V2.4 or higher). Through Rheocalc, all viscometer functions are controlled by the computer. The DV-II+Pro must be set to the external control mode to allow for proper communication with Rheocalc. To configure the external control mode, connect cable DVP-80 to the serial port on the DV-II+Pro **before** turning on the DV-II+Pro. With the DVP-80 cable in place, the DV-II+Pro will present the screen shown in Figure II-23 when it is turned on. If external control is selected, the DV-II+Pro will display Figure II-24 and only accept control commands from Rheocalc software.

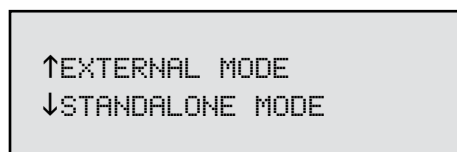

Figure II-23

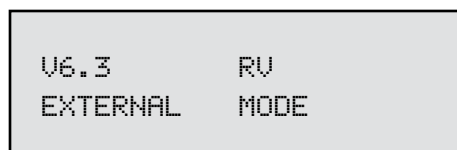

Figure II-24

The DV-II+Pro may be set to stand alone mode by turning it OFF and ON again and selecting “Stand Alone” or by removing the DVP-80 cable prior to turning the DV-II+Pro on.

*Note:* The DV-II+Pro cannot communicate with DVLOADER software in the external control mode. Choose “Stand Alone” when presented with Figure II-23 if you want to use DVLOADER.

For information on controlling the DV-II+Pro from Rheocalc software, check the HELP menu within Rheocalc.

## II.10 Making Viscosity Measurements

The following general procedure is used for making viscosity measurements. Brookfield recommends the use of a 600 ml Low Form Griffin beaker (Brookfield Part No. BKR-600ml) when using LV/RV/HA/HB spindles.

1. Mount the guardleg on the DV-II+Pro Viscometer (LV and RV series) and insert into the container.
2. Insert and center spindle in the test material until the fluid’s level is at the immersion groove on the spindle’s shaft. With a disc-type spindle, it is necessary to tilt the spindle slightly while immersing to avoid trapping air bubbles on its surface.
  - A) If you have a standard viscometer, attach the spindle to the coupling nut on the lower shaft of the viscometer. Lift the shaft slightly, holding it firmly with one hand while screwing the spindle on with the other (note: left-hand thread). Avoid putting side thrust on the shaft. Verify the proper spindle immersion depth and that the viscometer is level.
  - B) If you have an EZ-Lock viscometer, with one hand hold the spindle, while gently raising the spring-loaded outer sleeve to its highest position with the other hand, as shown in Figure II-7. Insert the EZ-Lock Spindle Coupling so that the bottom of the coupling is flush with the bottom of the shaft, and lower the sleeve. The sleeve should easily slide back down to hold the spindle/coupling assembly in place for use.
3. The process of selecting a spindle and speed for an unknown fluid is normally trial and error. **An appropriate selection will result in measurements made between 10-100 on the instrument % torque scale.** Two general rules will help in the trial and error process.
  - 1) Viscosity range is inversely proportional to the size of the spindle.
  - 2) Viscosity range is inversely proportional to the rotational speed.

To measure high viscosity, choose a small spindle and/or a slow speed. If the chosen spindle/speed results in a reading above 100%, then reduce the speed or choose a smaller spindle.

Experimentation may reveal that several spindle/speed combinations will produce satisfactory results between 10-100%. When this circumstance occurs, any of the spindles may be selected.

Non-Newtonian fluid behavior can result in the measured viscosity changing if the spindle and/or speed is changed. See our publication, “More Solutions to Sticky Problems,” for more detail.

Turn on motor.

Allow time for the indicated reading to stabilize. The time required for stabilization will depend on the speed at which the Viscometer is running and the characteristics of the sample fluid. For

maximum accuracy, readings below 10% should be avoided.

Record values.

4. Press the MOTOR ON/OFF/ESCAPE key and turn the motor “OFF” when changing a spindle or changing samples. Remove spindle before cleaning.
5. Interpretation of results and the instrument’s use with non-Newtonian and thixotropic materials is discussed in the booklet, “More Solutions to Sticky Problems”, and in Appendix C, Variables in Viscosity Measurements.

## II.11 Time Modes for Viscosity Measurement

The **Time Modes** allow the viscometer user to implement the unattended Time to Stop and Time to Torque capabilities of the DV-II+Pro Viscometer. These features will allow the user to set up the viscometer (i.e. select spindle and speed) and then record readings for a fixed period of time (Time to Stop) or until a set torque value is attained (Time to Torque). When timing begins, a message will be displayed showing time remaining (or time elapsed) and the appropriate display item (viscosity or torque) will be updated continuously during the event. Upon completion, the viscometer will stop and display a screen stating that the test is complete and will also display the final recorded value for the viscosity in the first case, or the time in minutes and seconds to reach the torque limit in the second case. Pressing the UP or DOWN ARROW keys will allow additional viscometer data to be examined. Pressing any other key (except the PRINT or ENTER/AUTORANGE key) will bring the user back to the default (normal) viscometer display with the motor OFF. Refer to the Time Modes in Section IV.3.

## III. MAKING VISCOSITY MEASUREMENTS

### III.1 Quick Start

The DV-II+Pro Viscometer uses the same methodology for viscosity measurements as the Brookfield Dial Reading Viscometers and DV series of Digital Viscometers. If you have experience with other Brookfield equipment, this section will give you quick steps for taking a viscosity reading. If you have not used a Brookfield Viscometer before, skip this section and go to Section III.2 for a detailed description.

- A) Assemble and level viscometer (Section I.4)
- B) Turn power on
- C) Autozero the viscometer (Section II.1)
- D) Enter the spindle number using the SELECT SPINDLE key (Section II.2).
- E) Introduce the spindle into the sample and attach the spindle to the coupling nut.  
**NOTE: Left-hand threads.** If equipped with EZ-Lock, use the appropriate procedure to connect the spindle [see Section II.2].
- F) Enter the speed of rotation using the number pad and ENTER key (Section II.3).
- G) Record % torque and viscosity.

### III.2 Preparations for Making Measurements

- A) **VISCOMETER:** The DV-II+Pro should be turned on, leveled and autozeroed. The level is adjusted using the two feet on the bottom of the base and confirmed using the bubble on the top of the head. Adjust the feet until the bubble is inside the center target. Set the level prior to autozero and check the level prior to each measurement.

**The proper level is essential for correct operation of the DV-II+Pro.**

- B) **SAMPLE:** The fluid to be measured (sample) must be in a container. The standard spindles supplied with the DV-II+Pro [LV (1-4), RV (2-7), or HA/HB (2-7)] are designed to be used with a 600 mL low form Griffin beaker (or equivalent container with a diameter of 8.25cm). The same applies to the optional RV1, HA/HB1, and Vane spindles. Many other spindle systems are supplied from Brookfield with specific sample chambers such as the Small Sample Adapter, UL Adapter and Thermosel.

Brookfield recommends that you use the appropriate container for the selected spindle. You may choose to use an alternate container for convenience, however, this may have an effect on the measured viscosity. The DV-II+Pro is calibrated considering the specified container. Alternate containers will provide results that are repeatable but not “true”.

The LV (1-4) and RV (1-7) are designed to be used with the guardleg attached. Measurements made without the guardleg will provide repeatable results but may not provide “true” results.

**When comparing data with others, be sure to specify the sample container and presence/absence of the guardleg.**

Many samples must be controlled to a specific temperature for viscosity measurement. When conditioning a sample for temperature, be sure to temperature control the container and spindle as well as the sample.



Please see our publication, “More Solutions to Sticky Problems”, for more detail relating to sample preparation.

### III.3 Selecting a Spindle/Speed

The DV-II+Pro has the capability of measuring viscosity over an extremely wide range. For example, the RVDV-II+Pro can measure fluids within the range of 100-40,000,000 cP. This range is achieved through the use of several spindles over many speeds. See Appendix B for details.

The process of selecting a spindle and speed for an unknown fluid is normally trial and error. **An appropriate selection will result in measurements made between 10-100 on the instrument % torque scale.** Two general rules will help in the trial and error process.

- 1) Viscosity range is inversely proportional to the size of the spindle.
- 2) Viscosity range is inversely proportional to the rotational speed.

In other words: to measure high viscosity, choose a small spindle and/or a slow speed. If the chosen spindle/speed results in a reading above 100%, then reduce the speed or choose a smaller spindle.

Experimentation may reveal that several spindle/speed combinations will produce satisfactory results between 10-100%. When this circumstance occurs, any of the spindles may be selected.

Non-Newtonian fluid behavior can result in the measured viscosity and yield stress changing if the spindle and/or speed is changed. See our publication, “More Solutions to Sticky Problems,” for more details.

**When viscosity data must be compared, be sure to use the same test methodology: namely the same instrument, spindle, speed, container, temperature and test time.**

### III.4 Multiple Data Points

The majority of viscosity and yield stress measurements are made at the quality control level and often consist of a single data point. The test is conducted with one spindle at one speed. The data point is a useful bench mark for the go/no-go decision in a production setting. The DV-II+Pro can be used for single point measurement.

Many fluids exhibit a characteristic change in viscosity and yield stress with a change in applied force. This non-Newtonian flow behavior is commonly seen in paints, coatings and food products as a decrease in viscosity as shear rate increases or an increase in yield stress as a rotational speed increases. This behavior cannot be detected or evaluated with the single point measurement.

Non-Newtonian flow is analyzed through the collection of viscosity data over a range of shear rates and the generation of a graph of viscosity versus shear rate (a rheogram). This information will allow for a more complete characterization of a fluid and may help in formulation and production of a product. The DV-II+Pro is capable of collecting multiple data points for comprehensive analysis of flow behavior.

More information on flow behavior, shear rate and rheograms is available in our publication, “More Solutions to Sticky Problems.”

## IV. OPTIONS

### IV.1



### Introduction to OPTIONS

The OPTIONS/TAB key provides access to the configuration (Setup) of the DV-II+Pro Viscometer as well as special functions that can enhance the user's ability to make viscosity measurements.

The Options menu, shown in Table 1, gives a complete picture of the various configuration choices and special functions.

#### Quick References to Options

*Table 2*  
*Options Menu*

<b>SETUP:</b>	
Temperature	— °F or °C
Units	— CGS or SI
* Speed Sets	— Sequential, Interleave, Custom
Printer Port	— Serial (RS232) or Parallel
Data Averaging	— Display Only
* <b>TIME TO STOP</b>	
* <b>TIME TO TORQUE</b>	
<b>SET PRINT TIME:</b>	
Set the Printing Time	
<b>PC PROG (ON/OFF):</b>	
Enables/Disables Communication of Serial (RS232) Port	
* <b>DOWNLOAD A PROGRAM:</b>	
Link to PC to Receive a B.E.V.I.S. Program (B.E.V.I.S. = <b>B</b> rookfield <b>E</b> ngineering <b>V</b> iscometer <b>I</b> nstruction <b>S</b> et)	
* <b>RUN A PROGRAM:</b>	
Execute a <u>B.E.V.I.S. Program</u>	
*Not available when motor is ON	

Pressing OPTIONS/TAB places you into the Options menu at the *last* option selected. The following keys are active and perform as follows:



UP ARROW

- Scrolls up through menu or selects new value from list.



DOWN ARROW

- Scrolls down through menu or selects new value from list.



OPTIONS/TAB

- Toggles between options.



ENTER/AUTORANGE

- Accepts the currently flashing option and moves user to the next level (if applicable) of the selected option.



MOTOR ON/OFF/ESCAPE

- Cancels current operation and backs user out *one* menu level. Repeated pressing will back the user out to the default screen. *While in the Options menu, the MOTOR ON/OFF/ESCAPE key does not cause the viscometer motor to turn on or off!*

The Options menu screens will appear, as shown in Figure IV-1, if you cycle through the possible options using the UP/DOWN arrows.

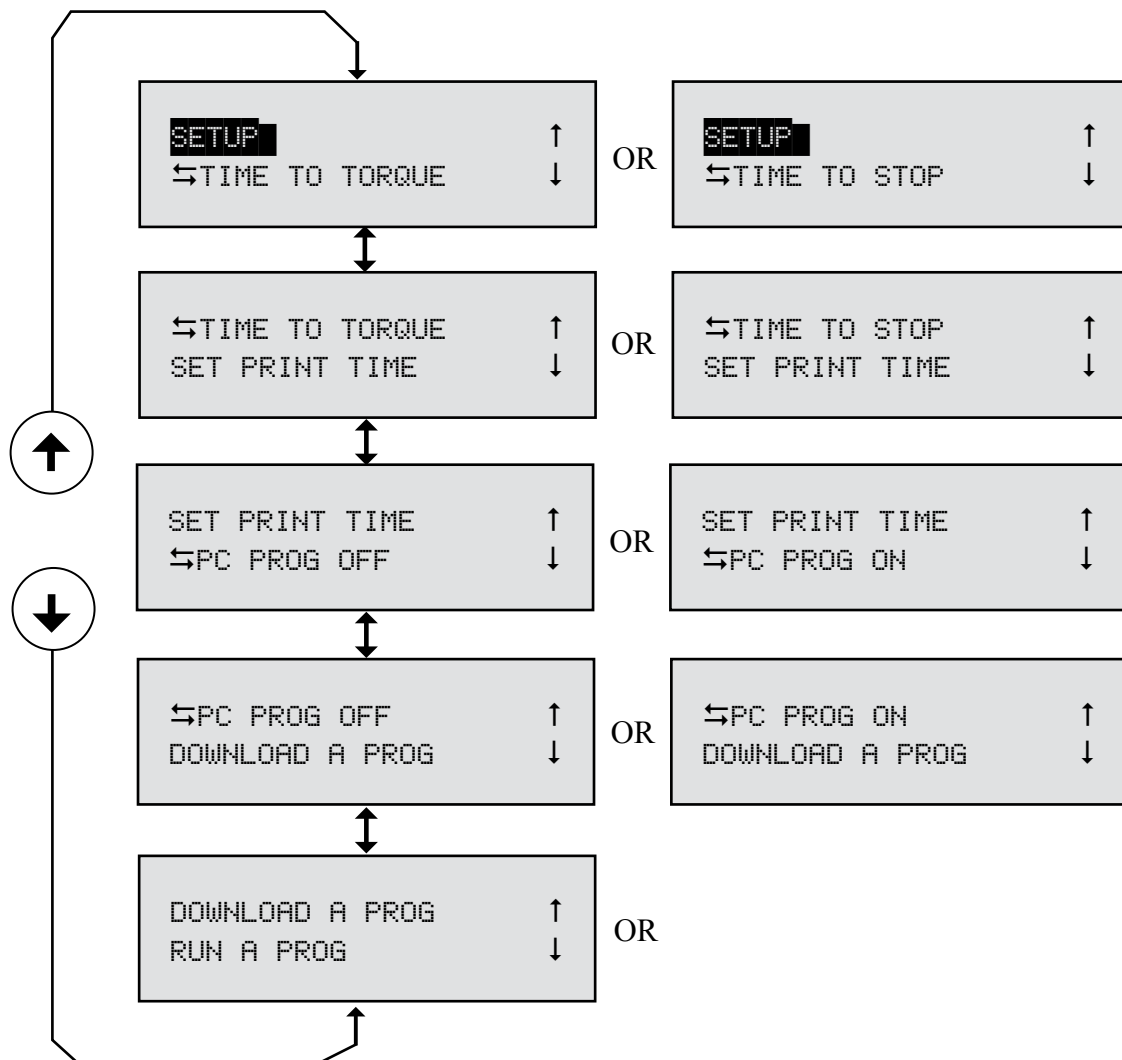



Figure IV-1



On entry to the Options menu, the following rules regarding current viscometer operation are in force:

1. Printer output will be suppressed when in the Custom Speed option, the Time to Torque and Time to Stop options, the Download A Program and Run A Program options. It will be continued when any other option is selected.
2. If the motor is ON when the user enters the Options menu, choices will be limited to: CGS/SI units (under SETUP), °F/°C units (under SETUP), PRINTING SELECTIONS and PC PROG.
3. The *last* selected menu option will be flashing.

### ***Selecting an Option***

The following is a quick reference for entering and using the **OPTIONS** menu:

Press  to enter Options Menu.

Press  or  to scroll to a specific option.

For Options:

Press  to toggle between the choices available for a specific option when indicated.

Press  to select the flashing option.

## **IV.2 Setup**

From the main Options screen, the user scrolls up or down until the following screen is displayed:

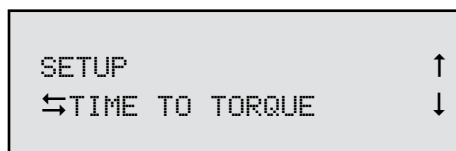

*Figure IV-2*

A press of the ENTER/AUTORANGE key takes you into the Setup sub-menu (Figure IV-3). As in the main Options menu, you can scroll up or down through the various Setup options. In order to access all options, the motor must be turned off.

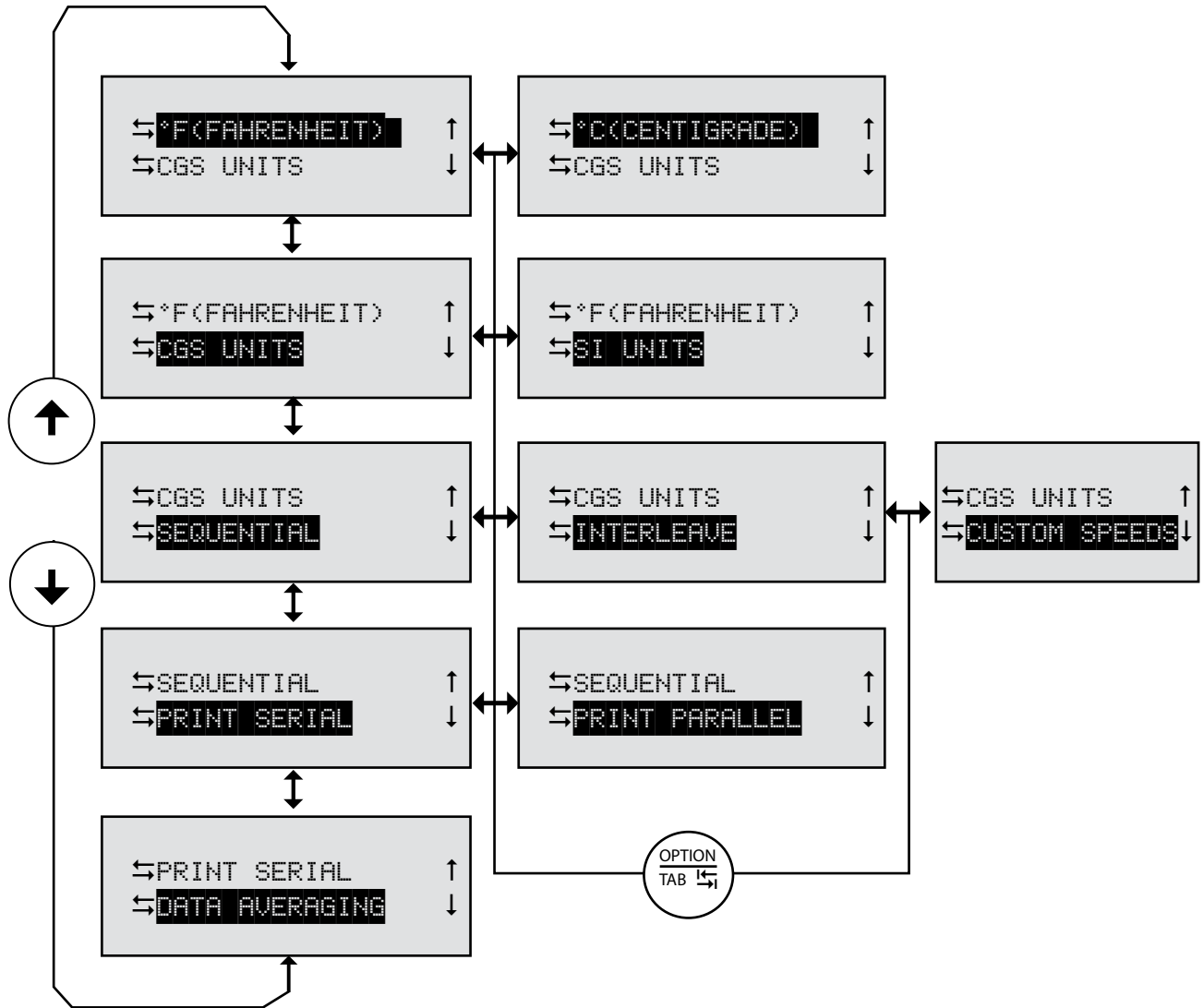

Figure IV-3

### IV.2.1 Temperature Display

The DV-II+Pro viscometer can display temperature in either degrees Centigrade or degrees Fahrenheit. On entry (assuming the viscometer is currently displaying °F), you will be presented with:

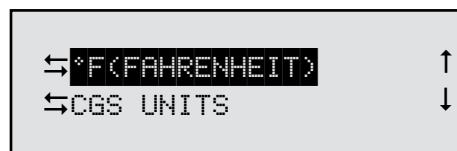

Figure IV-4

A press of the OPTIONS/TAB key at this point will “toggle” between the two available temperature scale options as shown in Figure IV-5:

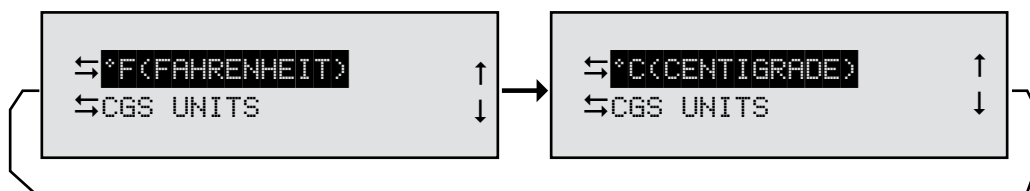

Figure IV-5

To select the temperature display mode, press the ENTER/AUTORANGE key. You automatically exit the Setup menu with the viscometer displaying temperature in the selected scale. You must press the ENTER/AUTORANGE key to select the flashing option.

### IV.2.2 Units of Measurement

Selecting units of measurement is identical to that for temperature described above. The screen display shows:

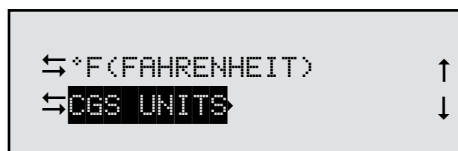

Figure IV-6

A press of the OPTIONS/TAB key at this point allows the user to “toggle” between the two available data display units as shown in Figure IV-7:

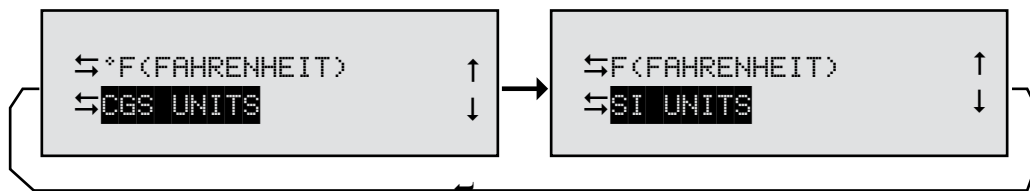

Figure IV-7

Pressing the ENTER/AUTORANGE key selects the display units, which are flashing, followed by an exit of the Setup menu. You must press the ENTER/AUTORANGE key to select the flashing option.

### IV.2.3 Motor Speed Set Selection

This selection must be done with the motor off. Scrolling in the Setup options menu to the speed set selection option yields the following screen display:



Figure IV-8

The last selected speed set option is displayed, in this case, *Sequential*. For each press of the OPTIONS/TAB key, the display shows selectable options (Figure IV-9). You must press the ENTER/

AUTORANGE key to select the flashing option.

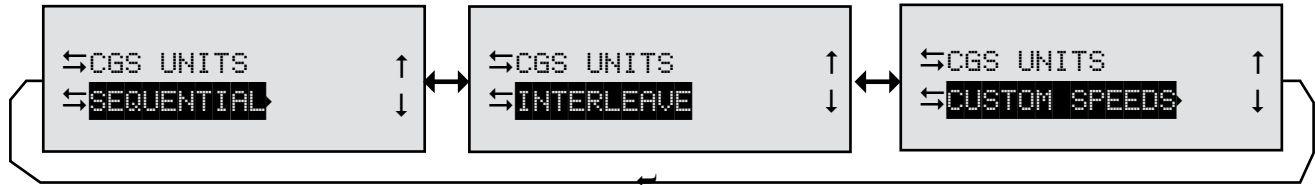

Figure IV-9

The speeds available in each of the above options are listed in Appendix G. The DV-II+Pro is initially set up with the Sequential Speed Set at Brookfield prior to shipment.

### IV.2.3.1 LV/RV Speeds

In the case of Sequential or Interleave, a press of the ENTER/AUTORANGE key immediately selects that option and exits the SETUP option menu.

### IV.2.3.2 Custom Speeds

Pressing the ENTER/AUTORANGE key when *Custom Speeds* is displayed results in the following screen display:



Figure IV-10

Fifty-four (54) speeds are available for custom speed set selection (see Appendix G). You are allowed to select up to nineteen (19) of these (54) available speeds. Speed 0.0 is automatically included as one of the nineteen (19) speeds. Selecting a speed (or deleting a speed) is accomplished by pressing the SET SPEED key while the desired speed is blinking. This will cause an asterisk to appear (or to disappear if the speed is being cleared) to the left of the speed. Trying to select more than nineteen (19) speeds will result in a “beep” for each press of the SET SPEED key when over this limit. You may scroll up or down through the speed set in selecting speeds. When done, a press of the ENTER/AUTORANGE key will take you back to the default screen with the asterisked speeds now comprising the custom speed set. Regardless of order chosen, speeds will appear in ascending order for run selection, beginning with speed 0.0 RPM.

### IV.2.4 Printer Output Port

Scrolling to the printer port option presents the following:

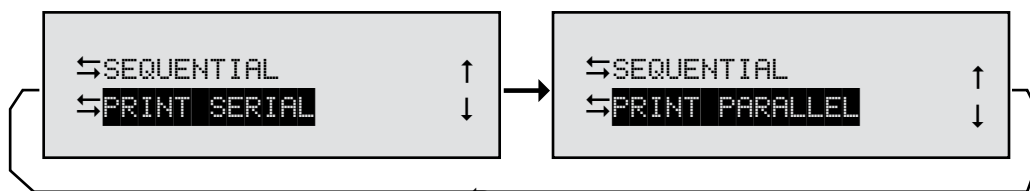

Figure IV-11

Pressing the OPTIONS/TAB key “toggles” between the two port choices. To select a printer output port, press the ENTER/AUTORANGE key while the desired choice is blinking. This will cause the DV-II+Pro to direct all further printer output to the chosen port while remaining in the Setup menu. You must press the ENTER/AUTORANGE key to select the flashing option.

## IV.2.5 Data Averaging

You must press the ENTER/AUTORANGE key to select the flashing option.

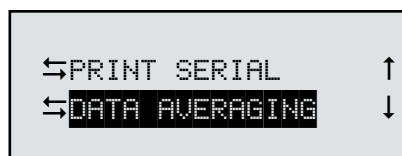

Figure IV-12

This feature will perform a “rolling” average on the displayed % torque value and all other displayed viscometer data derived from % torque. You are allowed to select the number of readings over which averaging is being done, with ten (10) readings as the maximum. There will be an initial delay as the first average is performed and then no apparent delay as the following readings are averaged (the viscometer takes approximately 4 readings per second). The rolling average is described as follows.

1. The first X readings are collected, placed in the averaging buffer, averaged and the average value is displayed.
2. The first reading in the averaging buffer is dropped; the next reading (the X + 1 reading) is placed in the buffer and the buffer is again averaged and displayed. Step 2 is repeated indefinitely until the viscometer is shut off or the user selects a different number of readings to average. The number of readings to be averaged will include zero (0) as an average so that this option may effectively be turned off without turning the viscometer off.

### Notes:

1. The data averaging will only be applied to the data displayed by the viscometer. No data averaging will be applied to the torque output signal.
2. Data averaging is not applied to temperature.
3. When data averaging taking place, a flashing A will be displayed to the left of the % Torque sign as shown in Figure IV-13.

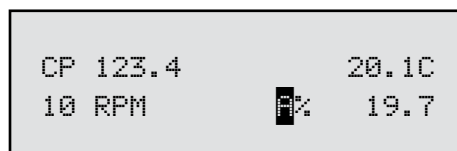

Figure IV-13



### IV.3 Time Modes

The Time Modes are provided to allow more flexibility by unattended operating of the viscometer during data gathering. The last selected option (i.e. Time to Torque or Time to Stop) will be highlighted when scrolling to this option as shown in Figure IV-14:

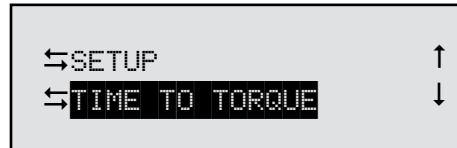

Figure IV-14

A press of the OPTIONS/TAB key will “toggle” between the two available timed modes as shown in Figure IV-15:

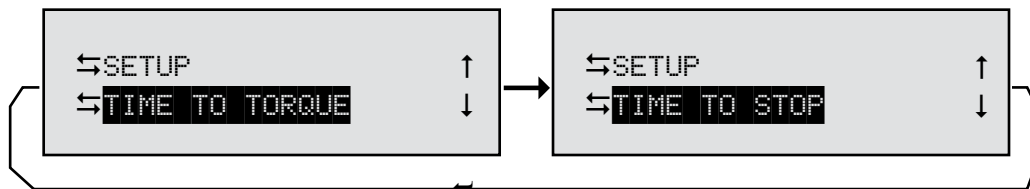

Figure IV-15

To enter the time for either of these options, press the ENTER/AUTORANGE key while the selected option is blinking. Let's start with Time To Stop.

*Note:* These two modes are immediately executed when input is complete. They do not return to the default screen until running is complete. They can be stopped at any time by a press of the MOTOR ON/OFF/ESCAPE key.

#### IV.3.1 Time to Stop

On entry, the user is presented with the following screen display:

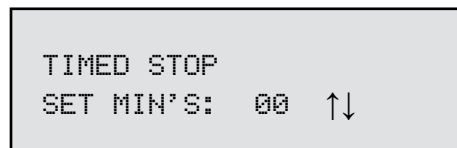
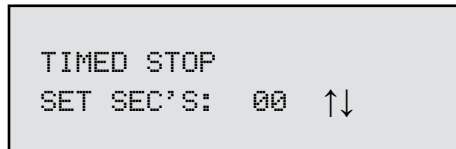

Figure IV-16

*Note:* If a time interval has already been set, the user may skip the time interval input and go directly to the speed input screen by pressing the ENTER/AUTORANGE key.

Using the UP and DOWN ARROW keys, the user enters a value for the minutes portion of the time ramp. This value can be as high as 59 minutes. When satisfied, the user presses the OPTIONS/TAB key again to enter the seconds setting display:

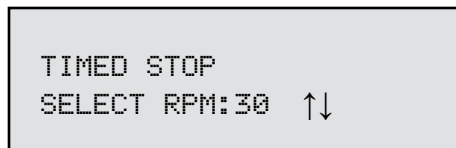

*Figure IV-17*

Using the UP and DOWN ARROW keys, the user enters a value for the seconds portion of the time ramp. This value will be from zero (0) up to fifty-nine (59) seconds. Press ENTER to accept the value.

*Note:* The value for either minutes or seconds must be other than zero or you cannot advance to the RPM input screen (Figure IV-18). Pressing the OPTIONS/TAB or ENTER/AUTORANGE keys will cause the user to alternate between the minutes input screen (Figure IV-16) and the seconds input screen (Figure IV-17) until either minutes or seconds are anything but zero.

A press of the ENTER/AUTORANGE key allows the user to input the RPM selection. At this point, the user will see a screen similar to Figure IV-18; using the UP and DOWN ARROW keys, the user sets the speed.



*Figure IV-18*

After selecting the speed, the user may review the values selected. If the user presses the OPTIONS/TAB key, you will return to the minutes input screen of Figure IV-16 where you may change the minute input if so desired. Thereafter, continued pressing of the OPTIONS/TAB key will toggle between the minutes and seconds input screens and the motor input screen. A press of the MOTOR ON/OFF/ESCAPE key will cancel the timed stop operation and take the user back to the screen of Figure IV-15. Pressing the ENTER/AUTORANGE key will cause the DV-II+Pro to accept the new values.

That done, the user is presented with the following screen:

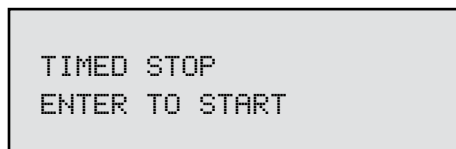

*Figure IV-19*

At this point the user must press the ENTER/AUTORANGE key to begin the timed stop operation. Any other key press will be ignored except the MOTOR ON/OFF/ESCAPE key which will cancel the process and take the user back to the screen of Figure IV-15 where you will have to begin all over again.

We will assume that the user pressed the ENTER/AUTORANGE key. You will now be presented with the following screen for the duration of the timed run:

```
cP 123.5e6
MIN: 15 SEC: 13
```

*Figure IV-20*

*Note:* When this mode has begun, a press of the MOTOR ON/OFF/ESCAPE key will cancel the Timed Stop sequence and return the user to the screen of Figure IV-14. Also note that data will be displayed in the currently selected method i.e. CGS or SI units. Pressing the SELECT DISPLAY key allows display of alternate data values such as Shear Stress, Shear Rate or Torque.

The seconds display will decrement from fifty-nine (59) to zero (0) in one (1) second intervals. When seconds reaches zero (0), the minutes value will decrement by one (1) minute. This will continue until all of the time has elapsed at which point the viscometer will display the following screen:

```
cP 123e6
TIMED STOP DONE
```

*Figure IV-21*

At this point the viscometer will stop the motor and continue to display this screen until any key, except the UP or DOWN ARROW key, the PRINT key or the SELECT DISPLAY key, is pressed. The user can, while this display is current, press the UP or DOWN ARROW keys to view the torque and speed that were current at the time the display was frozen. The display would appear as follows:

```
%=76.4 RPM=100
TIMED STOP DONE
```

*Figure IV-22*

The display will switch between that of Figures IV-21 and IV-22 for each press of the UP or DOWN arrow keys. A press of the PRINT screen would send one standard print line to the attached printer for each press of the PRINT key. Pressing any key (except the UP or DOWN ARROW keys, the PRINT key or the SELECT DISPLAY key) will cause the viscometer to return to the Timed Stop Start Screen of Figure IV-19 displayed awaiting another Timed Stop run.

*Note:* To run multiple timed stop tests, the user needs to press ENTER twice from the screen shown as Figure IV-22.

The user can press the PRINT key while in either of these two screens (Figures IV-21 and IV-22) to send one standard print string to the attached printer as many times as the user presses the PRINT key. In addition, the PRINT key can be pressed during the actual measurement to obtain instantaneous data. Pressing any other key will exit this mode and return the viscometer to normal operation.

### IV.3.2 Time to Torque

On entry to this mode, the user is presented with the following screen display:

```
TIMED TO TORQUE
SET TORQUE:00% ↑↓
```

*Figure IV-23*

Using the UP or DOWN ARROW keys, the user enters a value for the torque level that you wish to reach.

*Note:* The value for torque must be other than zero (0) and less than or equal to ninety-nine (99) percent or you will not be able to continue.

At this point, the user presses the OPTIONS/TAB key and the screen shown in Figure IV-24 appears:

```
TIME TO TORQUE
SELECT RPM: 30 ↑↓
```

*Figure IV-24*

Using the UP or DOWN ARROW keys, the user selects a speed from the currently selected speed set. If you had opted to use the LVRV sequential or interleaved speed sets, all those speeds would be available by pressing the UP or DOWN ARROW keys. Conversely, if the user had selected a custom speed set, you would be limited to those speeds comprising the custom speed set. After selecting the speed, the user may press any one of three keys to continue: the OPTIONS/TAB key, the MOTOR ON/OFF/ESCAPE key and the ENTER/AUTORANGE key. If the user presses the OPTIONS/TAB key you will return to the torque input screen of Figure IV-23 where you may change the torque input if so desired. Therefore, continued pressing of the OPTIONS/TAB key will toggle between the torque input screens and the motor input screen. A press of the MOTOR ON/OFF/ESCAPE key will cancel the time to torque operation and take the user back to the screen of Figure IV-14. Finally, pressing the ENTER/AUTORANGE key will cause the DV-II+Pro to accept and store in EEPROM the new values (only) for the torque level and the selected motor speed.

That done, the user is presented with the following screen:

```
TIME TO TORQUE
ENTER TO START
```

*Figure IV-25*

At this point the user must press the ENTER/AUTORANGE key to begin the timed stop operation. Any other key press will be ignored except the MOTOR ON/OFF/ESCAPE key which will cancel the process and take the user back to the screen of Figure IV-23 where you will have to begin all over again.

We will assume that the user pressed the ENTER/AUTORANGE key. You will now be presented with a screen similar to Figure IV-26 for the duration of the timed torque run:

```
TORQUE = 24.2%  
MIN: 15    SEC: 13
```

Figure IV-26

*Note:* When this mode has begun, a press of the MOTOR ON/OFF/ESCAPE key will cancel the time to torque sequence and return the user to the screen of Figure IV-14.

The seconds display will increment from zero (0) to fifty-nine (59) in one (1) second intervals and the current value of the viscometer torque will be updated continuously. When seconds reaches fifty-nine (59), the minutes value will increment by one (1) minute. This will continue until the user selected torque value is attained at which point the viscometer will display the following screen:

```
22MIN 54SEC: 85%  
TIMED TORQ DONE
```

Figure IV-27

At this point the viscometer will stop the motor and continue to display this screen until any key (except the UP or DOWN ARROW keys, the PRINT key or SELECT DISPLAY key) is pressed. The user can, while this display is current, press the UP or DOWN ARROW keys to view the viscosity that was current at the time the display was frozen. The display would appear as follows:

```
cP 123.5e6  
TIMED TORQ DONE
```

Figure IV-28

The display will switch between that of Figures IV-27 and IV-28 for each press of the UP or DOWN ARROW keys. As stated above, pressing any key (except the UP or DOWN ARROW or PRINT keys) will cause the viscometer to exit the Time To Torque mode and resume operation with the screen of Figure IV-23 displayed awaiting another Timed Torque run.

The user can press the PRINT key while in either of these two screens (Figures IV-26 and IV-27) to send one standard print string to the attached printer as many times as the user presses the PRINT key. In addition, the PRINT key can be pressed during the actual measurement to obtain instantaneous data. Pressing any other key will exit this mode and return the viscometer to normal operation.

*Note:* For both of the methods of Sections IV.3.1 and IV.3.2 the following apply:

1. For the Timed Stop method, the DV-II+Pro viscometers will retain the last value for the time interval so that it will become the default the next time the user elects to use this method.
2. For the Time To Torque method, the DV-II+Pro viscometers will retain the last entered torque value for use when next the user elects to perform a time to torque test.
3. The user can set up a desired print interval time, then set the viscometer to the continuous

print mode and finally initiate either of the timed modes of operation. While setting up the timed mode parameters, continuous print operation will cease. However, upon starting the timed operation, the DV-II+Pro will output an initial data string to the printer and then continue printing data strings (at the user defined time interval) for the duration of the timed run. At the end of the timed run, continuous printing will again be disabled and the user may print single strings (of the final data point) at your option until you exit the timed mode. Upon returning to the default operation mode, continuous printing will again resume at the user selected time interval. In a similar manner, if you are in the once-per-PRINT -key-press mode, when you enter the timed mode of operation you will be able to print data strings at any time during the timed mode by pressing the PRINT key.

### IV.3.3 Print Time Interval

This option is used to set the print time interval to the selected printer. Scroll to Set Print Time, as shown in Figure IV-29:

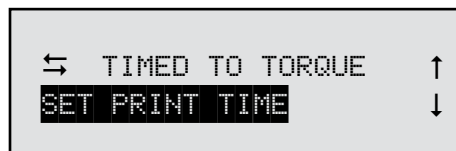

Figure IV-29

Press the ENTER/AUTORANGE key. On entry, Figure IV-30 is displayed:

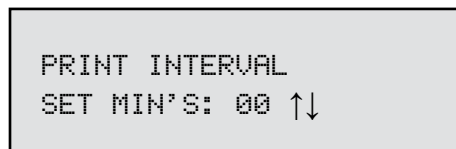

Figure IV-30

Using the UP and DOWN ARROW keys, enter a value for the minutes between successive print strings. This value can be as high as fifty-nine (59) minutes and as low as 00.

When satisfied, press the OPTIONS/TAB key to enter the seconds setting display:

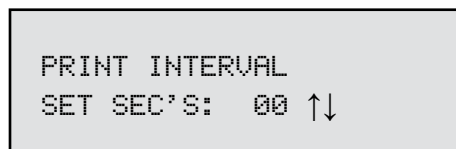

Figure IV-31

Using the UP and DOWN ARROW keys, enter a value for the seconds portion of the print interval. This value can be between zero (0) and fifty-nine (59) seconds.

*Note:* The value for minutes or seconds must be other than zero (0) or you will print continuously when you exit this mode. A press of the MOTOR ON/OFF/ESCAPE key would exit this option and take you back to the screen of Figure IV-29.

Continued pressing of the OPTIONS/TAB key will toggle between the minutes and seconds input screens. Press the ENTER/AUTORANGE key to accept the new values for print interval in minutes and seconds. You will now be in the screen display of Figure IV-29 where you may re-enter the print interval mode, or exit to the default screen (Figure II-5) by pressing the MOTOR ON/OFF/ESCAPE key.

Activating print selections in the Print mode can only be done by exiting to the main menu and pressing the PRINT key for four (4) seconds. “P%” will flash in front of the torque reading, confirming that you are now in the Print Interval mode. Pressing PRINT for one (1) second thereafter will disable the Print mode and remove the “P%” from the display.

#### IV.3.4 PC Program (On/Off)

*Note:* This option does not apply to use with RHEOCALC software.

This option causes the serial port of the DV-II+Pro viscometer to go into a high speed output mode (approximately 3 print lines per second) for use with Brookfield WINGATHER® software program. When ON, you may enter the Options menu but will not be allowed to make any option selections until the PC PROG is turned OFF. All front panel keys will function normally when you turn the option ON and return to normal viscometer operation by pressing the MOTOR ON/OFF/ESCAPE key. When OFF, the DV-II+Pro will return to the last set print time interval when printing is resumed.

*Note:* WINGATHER® software can be used for data acquisition and analysis. Rheocalc software can be used for complete external control of DV-II+Pro and data acquisition.

From the Options menu, scroll to the screen shown in Figure IV-32:



```
SET PRINT TIME      ↑
↔ PC PROG OFF      ↓
```

*Figure IV-32*

Press the OPTIONS/TAB key to display Figure IV-33:



```
SET PRINT TIME      ↑
↔ PC PROG ON       ↓
```

*Figure IV-33*

Pressing the OPTIONS/TAB key would return you to the screen display of Figure IV-32. Repeated pressing of the OPTIONS/TAB key would cause you to toggle back-and-forth between the displays of Figure IV-32 and Figure IV-33.

To turn high speed output ON, press the ENTER/AUTORANGE key when the appropriate screen is displayed. Then press the MOTOR ON/OFF/ESCAPE key to exit the Setup mode. This returns you to the default screen display and resumes normal viscometer operation with high speed output enabled and normal printer operation using the last entered print time interval.

*Note:* For access to B.E.V.I.S. option, PC PROG must be OFF.

### IV.3.5 Download a Program

Please refer to Section V for details on how to create a program before proceeding with this section.

In the Options menu, scroll to the screen shown in Figure IV-34:



Figure IV-34

Refer to Section IV for information on how to create B.E.V.I.S. programs on a PC which can be downloaded to the DV-II+Pro Programmable Viscometer.

Press the ENTER/AUTORANGE key to download a B.E.V.I.S. program as shown in Figure IV-35:

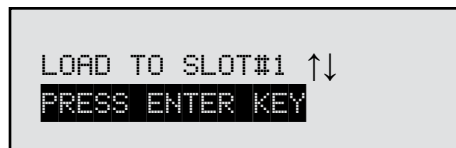

Figure IV-35

Select a number from one (1) to four (4) using the UP/DOWN ARROW keys assign a storage location for the program to be downloaded.

*Note:* Remember to keep track of what program is in what slot. If you elect to download a new program to an active slot, you will overwrite the program currently residing in that slot. The programs are saved automatically when the viscometer is turned off.

After selecting the slot number, press the ENTER/AUTORANGE key and the screen shown in Figure IV-35 changes as follows: the top line flashes while the bottom line disappears. This flashing screen will be displayed for as long as it takes to download the program. At the end of the download, Figure IV-36 is displayed:

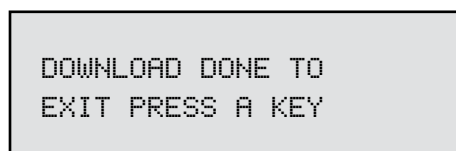

Figure IV-36

If a PC is not attached, Figure IV-37 will be displayed:

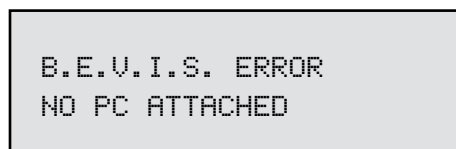

Figure IV-37



A press of any key (except the MOTOR ON/OFF/ESCAPE key) will take the user back a level to Figure IV-34 where you may elect to download another program or, with a press of the MOTOR ON/OFF/ESCAPE key, return to the screen of Figure IV-33.

### IV.3.6 Run a Program

In the Options menu, scroll to the screen shown in Figure IV-38:



*Figure IV-38*

Press the ENTER/AUTORANGE key to run a B.E.V.I.S. program as shown in Figure IV-39:

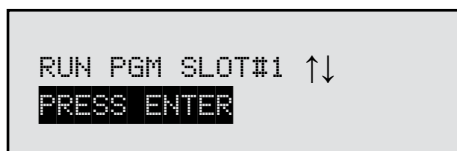

*Figure IV-39*

Using the UP/DOWN ARROW keys, select one of the four (4) stored programs. Press the ENTER/AUTORANGE key. Any attempt to select a program slot that does not contain a program will result in a double beep for each key press. When a valid program slot is selected, the screen in Figure IV-40 is displayed:

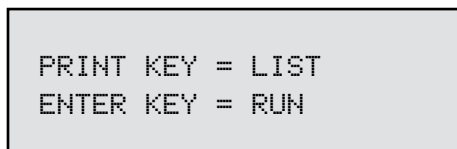

*Figure IV-40*

At this point, you may elect to print the B.E.V.I.S. program by pressing the PRINT key or start the program immediately by pressing the ENTER/AUTORANGE key (remember: pressing the MOTOR ON/OFF/ESCAPE key will stop the current operation and bring you back one menu level). You may elect to print the program, to confirm the slot choice as correct or simply to have it available later when reviewing data. If you elect to print the program, you will return to the screen of Figure IV-39 after the program is finished printing. Pressing the ENTER/AUTORANGE key exits the screen of Figure IV-39 and the program will start running.

On program start, the screen could be any of the screens possible when running a B.E.V.I.S. program. A typical screen might be:

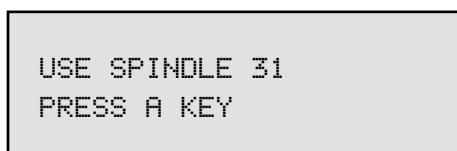

*Figure IV-41*

where the operator is instructed to mount a spindle 31 and then press a key to continue. Or you might see:

```
SET TEMP TO 100C  
PRESS A KEY
```

*Figure IV-42*

followed by:

```
WAIT TEMP 100C  
P1 S00/12 00:14
```

*Figure IV-43*

Here, the B.E.V.I.S. program is waiting for the temperature to reach one hundred (100) °C before it continues to the next program step. Also displayed is the program number (**P1**), the step number and the total program steps (**S00/12**) and the elapsed time since the program (or step) began (**00:14**). While in this “wait state” you can press the OPTIONS/TAB key to see the viscometer default screen in Figure IV-44; the PGM will be flashing.

```
CP 123.4 55.1C  
10 RPM PGM% 63.7
```

*Figure IV-44*

The DVLOADER Software is used to create, save, print, and down load programs to the DV-II+Pro Viscometer. The next section explains how to use the DVLOADER software.

## V. DVLOADER SOFTWARE

The DVLOADER software is a WINDOWS-based program provided on a CD which comes with the Programmable DV-II+Pro Viscometer.

### V.1 B.E.V.I.S. Overview

DVLOADER utilizes B.E.V.I.S. (Brookfield Engineering Viscometer Instruction Set), a scripting language that allows for the creation of programs to control the Programmable DV-II+Pro Viscometer. Programs are created on a PC, then loaded into the viscometer using the DVLoader software. Some testing capabilities that are possible include the following:

- Repeatedly run the same test program for quality control purposes.
- Wait for a specific condition before continuing with the test (i.e. a torque value, a temperature value, a key press, etc.).
- Run the viscometer at any of the speeds in the Custom Speed menu.
- Display messages to the screen or an attached printer to aid the operator.
- An internal clock that keeps time between each printed data line (this time is displayed as the last parameter on each printed line). This provides a consistent time base for the collected data.

### V.2 Description of B.E.V.I.S. Commands

Command Code	Required Parameter	Command Description
WTI	Time (MM:SS)	The program waits at this step until the specified time elapses.
WPT	% Torque value (%)	The program waits at this step until the current % torque equals the specified value.
WTP	Temperature value (°C)	The program waits at this step until the current temperature equals the specified value.
WKY	16 character (or less) text message	The specified message is displayed on the top line of the DV-II+ display while <b>PRESS A KEY</b> is displayed on the bottom line of the DV-II+Pro. The program waits at this step until a viscometer key is pressed. While waiting at this step, the viscometer produces a beep every few seconds to remind the operator that a keypress is required to continue. If a print interval was enabled (see SPI) at the time this command is executed, the data print timer continues to count up. If the print interval elapses and a key has not yet been pressed, a line of data displaying the time since the last data print is printed as soon as a key is pressed.
SSN	Speed value (RPM)	The DV-II+Pro begins rotating at the specified speed. This can be any of the speeds listed in the Speed list of the DVLoader software. These speeds are the same as those listed in the Custom Speeds list in the viscometer's Options menu.
SPI	Time (MM:SS)	The DV-II+Pro begins printing data to the selected printer (serial or parallel; as selected in the DV-II+Pro menus) at the rate specified. MM:SS is minutes:seconds.

SSP	Two digit spindle code	Calculations of viscosity, shear stress, and shear rate are performed based on the specified spindle code. This command overrides the spindle currently entered via the keypad on the DV-II+Pro.
STZ	N/A	Sets the data print timer clock back to zero.
PDN	N/A	The DV-II+Pro immediately prints a data string to the selected printer (serial or parallel; as selected in the DV-II+Pro menus).
PLN	16 character (or less) text message	The DV-II+Pro prints the specified message to the selected printer (serial or parallel; as selected in the DV-II+Pro menus).

By using various combinations of the above commands, programs are created that automatically control the viscometer and collect data (via an attached printer) from the Programmable DV-II+Pro Viscometer.

### V.3 Creating a B.E.V.I.S. Program

Start the DVLOADER software by clicking on its associated icon. For Windows 95/98/NT/2000, click the Start button; select Run; enter the name of the program to execute {dvloader.exe}; then click OK.

The B.E.V.I.S. commands are displayed in a list box on the main screen. This list box displays the commands available for creating programs. Clicking on the Insert button inserts the highlighted command (WTI, as shown in Figure IV-1) into the selected line in the program grid. Double-clicking on a line in this list box also inserts the command into the grid shown in Figure IV-2.



Figure IV-1

The icons to the left of the command descriptions indicate the type of command:



A command to wait for a condition.



A command to set a program parameter.



A command to send information to an attached printer.

1	SSN	50.0
2	WTI	00:30
3	SPI	00:05
4	WPT	75.0
5	SSN	25.0
6	WTI	00:10
7	WPT	75.0
8	SSN	0.0
9		
10		
11		
12		
13		
14		
15		
16		
17		
18		
19		
20		
21		
22		
23		
24		
25		

Figure IV-2 shows the grid where the operator programs are created. It is used to view and edit the B.E.V.I.S. programs. When the software starts, an empty grid appears on the left of the screen. You can choose up to 25 commands for your program. Highlight each command in the list box to the right of this grid, then click on the Insert button to insert that same command into the highlighted line of the grid. This same insertion task can also be accomplished by double-clicking on the appropriate command in the list box to the right.



In the case of a speed command (SSN), the Speeds list box becomes enabled when the cursor is placed in the parameter column for an SSN command. Click on the down arrow to display a list of available speeds. Click on the desired speed, and it will be inserted into the appropriate parameter column in the program grid. The same applies to the spindle command (SSP).

**Figure IV-2**

The buttons shown on the main screen are explained below.

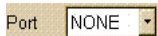

Select the COM (RS-232) port the Programmable DV-II+Pro Viscometer is connected to from the COM Port drop down list.

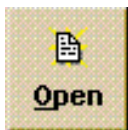

Click the Open File button to load existing B.E.V.I.S. programs.



Click the Save File button to save the B.E.V.I.S. program displayed in the grid.



Click the Print button to print the B.E.V.I.S. program displayed in the grid.



Click the Insert button to insert the B.E.V.I.S. command selected in the Commands box into the selected row in the program grid.



Click the Delete button to delete the B.E.V.I.S. command in the selected row of the program grid.



Click the Up button to move the B.E.V.I.S. command in the selected row of the program grid up one row.



Click the Down button to move the B.E.V.I.S. command in the selected row of the program grid down one row.



Click the Clear button to clear the grid of all B.E.V.I.S. commands. Once cleared, the commands cannot be retrieved.



Downloads a B.E.V.I.S. program from the PC to the DV-II+Pro



Exits the DVLOADER software program and returns the user to the WINDOWS Program Manager.

#### V.4 Downloading a B.E.V.I.S. Program

Before down loading a B.E.V.I.S. program to the viscometer, ensure the following have been checked:

- The appropriate cable (BEL Part# DVP-80) is connected between the selected COM port of the PC and the viscometer.
- The DV-II+Pro motor must be OFF.
- Set **PC PROG** to “OFF.”
- The Programmable DV-II+Pro is at the down load screen: **OPTIONS|DOWNLOAD A PROG|LOAD TO SLOT#x** where x is slot 1,2,3, or 4. See Section III.6.

With the **LOAD TO SLOT#x** screen displayed, choose a storage slot using the DV-II+Pro arrow keys then press the **ENTER/AUTO RANGE** key on the viscometer. If after 5 seconds, the viscometer cannot communicate with the DVLoader program, the **B.E.V.I.S. ERROR NO PC ATTACHED** message is displayed and a beeping sound is heard. If a connection is established, the Down Load button on the PC software becomes enabled , and the DV-II+Pro screen displays **DOWNLOAD PROG TO STORAGE SLOT #1**. Click on this button to download the displayed program to the DV-II+Pro. When the down load is complete, the DV-II+Pro displays **DOWNLOAD DONE TO EXIT PRESS A KEY**.

At this point, the program in the DV-II+Pro can be printed and/or run from the viscometer.



Click on this button to exit the DVLOADER software.

*Note:* This is an important final step because it allows the RS232 port to be used for output from the DV-II+Pro to a serial printer or PC.

## V.5 Example Programs

The following example programs can also be found on the DVLoader disk that was included with the DV-II+Pro Programmable Viscometer:

### Program 1: Pre-Shear

Command	Command Description	Parameter	Comments
PLN	Print text now	Preshearing now	print user message
SSN	Set viscometer speed	50.0	run at 50 RPM
WPT	Wait for % torque	90.0	wait until 90% torque is reached
PLN	Print text now	Collecting data	print user message
SPI	Set print interval	00:10	begin printing data at 10 second intervals
SSN	Set viscometer speed	10.0	run at 10 RPM
WTI	Wait for time interval	01:40	wait at this step for 1 minute and 40 seconds, effectively printing 10 data lines

### Program 2: For use with an external temperature controller

Command	Command Description	Parameter	Comments
WTP	Wait for temperature	40.0	wait until temperature = 40°C (as an example, a Thermosel/Controller can be used for temperature control)
WTI	Wait for time interval	05:00	soak time; allow temperature to settle
SSN	Set viscometer speed	25.0	run at 25 RPM
SPI	Set print interval	00:30	begin printing data at 30 second intervals
WTI	Wait for time interval	06:00	wait at this step for 6 minutes, effectively printing 12 data lines

### Program 3: Wait for cure (time to torque measurement)

Command	Command Description	Parameter	Comments
SSP	Set spindle	31	set to a number 31 spindle
SSN	Set viscometer speed	100.0	run at 100 RPM
SPI	Set print interval	00:05	begin printing data at 5 second intervals

<b>Command</b>	<b>Command Description</b>	<b>Parameter</b>	<b>Comments</b>
WPT	Wait for % torque	85.0	wait until % torque = 85; a curing cycle

Program 4: Spring relax

<b>Command</b>	<b>Command Description</b>	<b>Parameter</b>	<b>Comments</b>
WKY	Wait for a key press	Wind to 100%	tell operator to wind spindle until 100% torque is reached
WPT	Wait for % torque	100.0	wait until 100% torque is reached
WKY	Wait for a keypress	Release spindle	tell operator to release the spindle
SPI	Set print interval	00:01	begin printing data at 1 second intervals
WPT	Wait for % torque	0.0	wait for spindle to completely unwind to 0% torque

Program 5: Variable speed

<b>Command</b>	<b>Command Description</b>	<b>Parameter</b>	<b>Comments</b>
SSN	Set viscometer speed	5.0	run at 50 RPM
WTI	Wait for time interval	00:10	wait for 10 seconds
PDN	Print data point now		print one data point
SSN	Set viscometer speed	10	run at 10 RPM
WTI	Wait for time interval	00:10	wait for 10 seconds
PDN	Print data point now		print one data point
SSN	Set viscometer speed	20	run at 20 RPM
WTI	Wait for time interval	00:10	wait for 10 seconds
PDN	Print data point now		print one data point
SSN	Set viscometer speed	5.0	run at 50 RPM
WTI	Wait for time interval	00:10	wait for 10 seconds
PDN	Print data point now		print one data point



## VI. AUTOMATED DATA GATHERING & ANALYSIS

There are two choices of applications software that can be purchased from Brookfield or an authorized dealer for this purpose:

1. WINGATHER is a data gathering program which collects data output from the DV-II+Pro and provides the capability to perform graphical analysis and data file management.
2. Rheocalc is a control program which operates the DV-II+Pro in external control via a PC as well as a data gathering program for the purpose stated above in the WINGATHER description.

### V1.1 WINGATHER

Important features and benefits in WINGATHER which enhance operator versatility in performing viscosity tests include the following:

- 32-bit operation for rapid performance
- Wingather version 3.0 is compatible with Windows™ 2000, NT, XP, Vista, and Windows™ 7 operating systems for flexible operation.
- Brookfield's DV Loader software (for setting up test programs) is integrated into WINGATHER. DV Loader is an easy-to-use, structured command language which makes detailed viscosity tests simple to program (see Section V).
- Easy-to-use data gather modes including automatic follow up events (save data, analyze data, print data)
- Manual scaling of plot axes
- Auto range feature which shows in screen display the complete viscosity range which can be measured at any shear rate for a specific spindle geometry
- Concurrent plotting of six data sets on one graph

The following figures show the principal screens associated with WINGATHER:

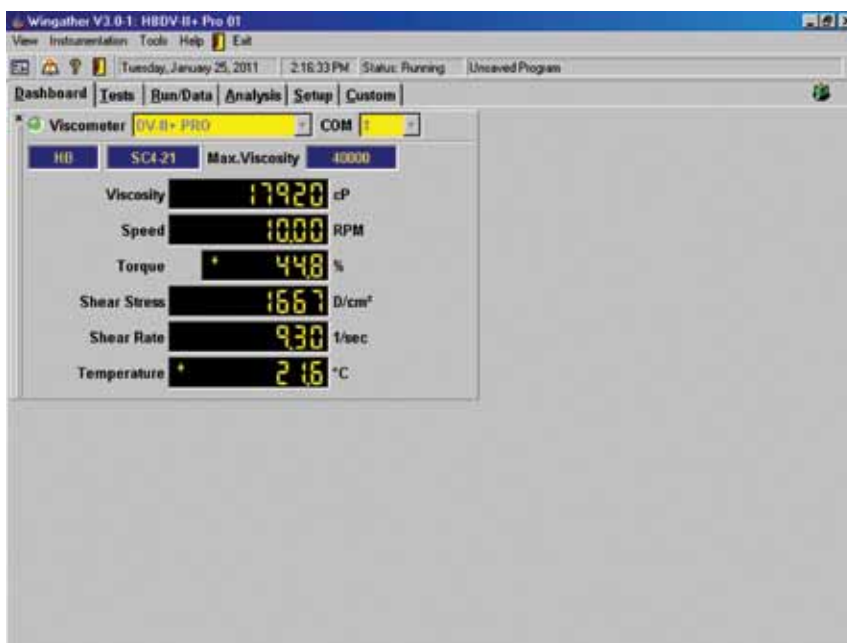

Figure V1-1: Dashboard Screen

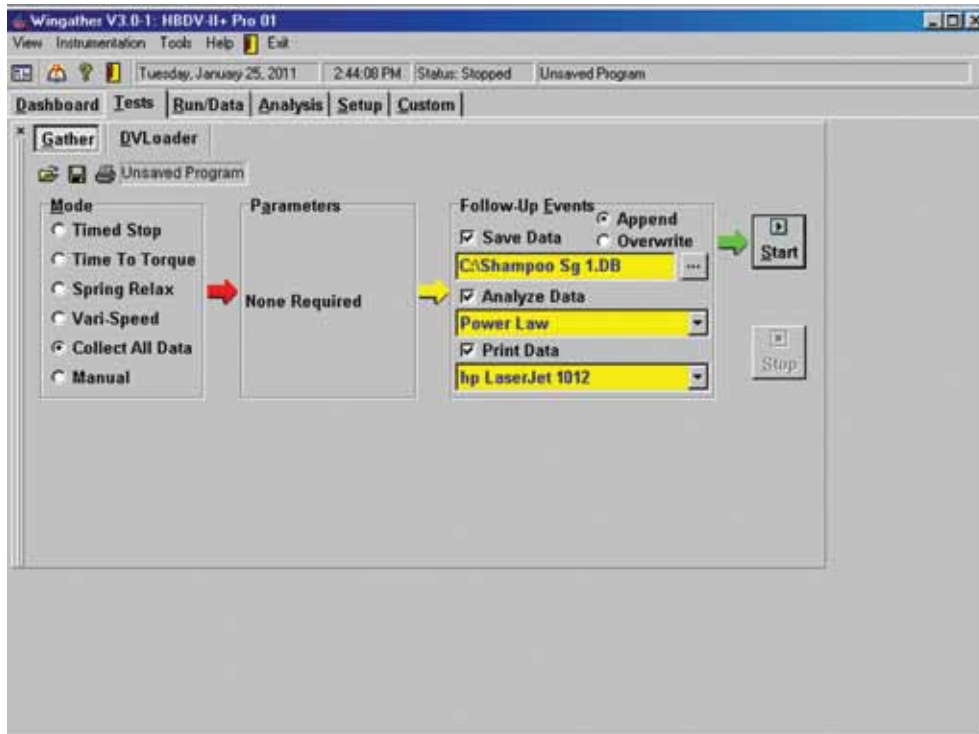

Figure VI-2: Gather Screen

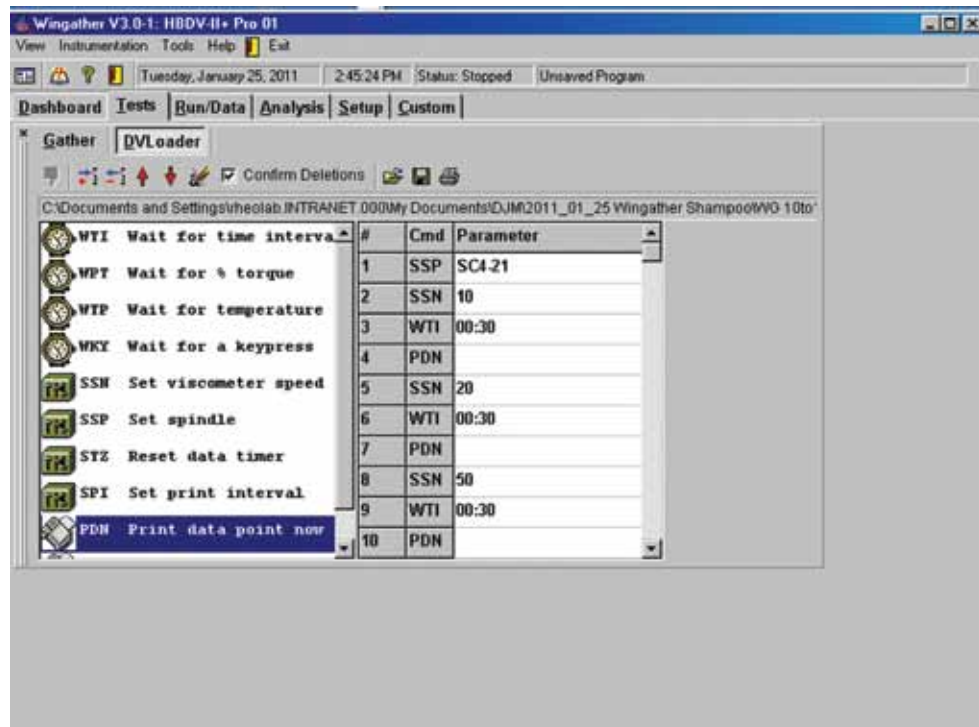

Figure VI-3: DV Loader Screen

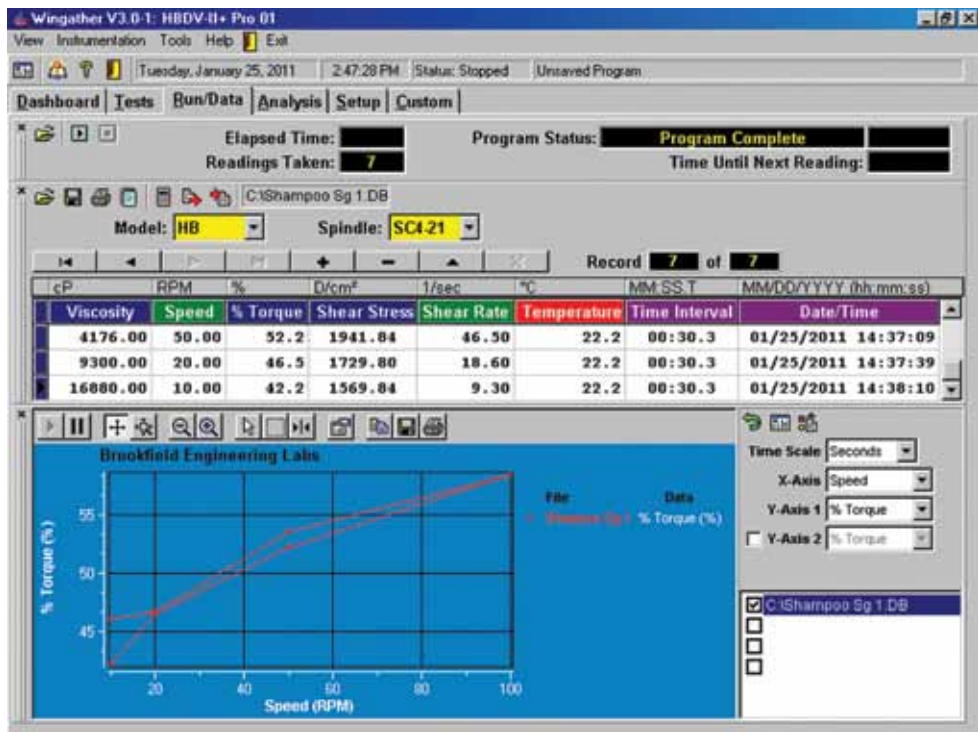

Figure VI-4: Run/Data Screen

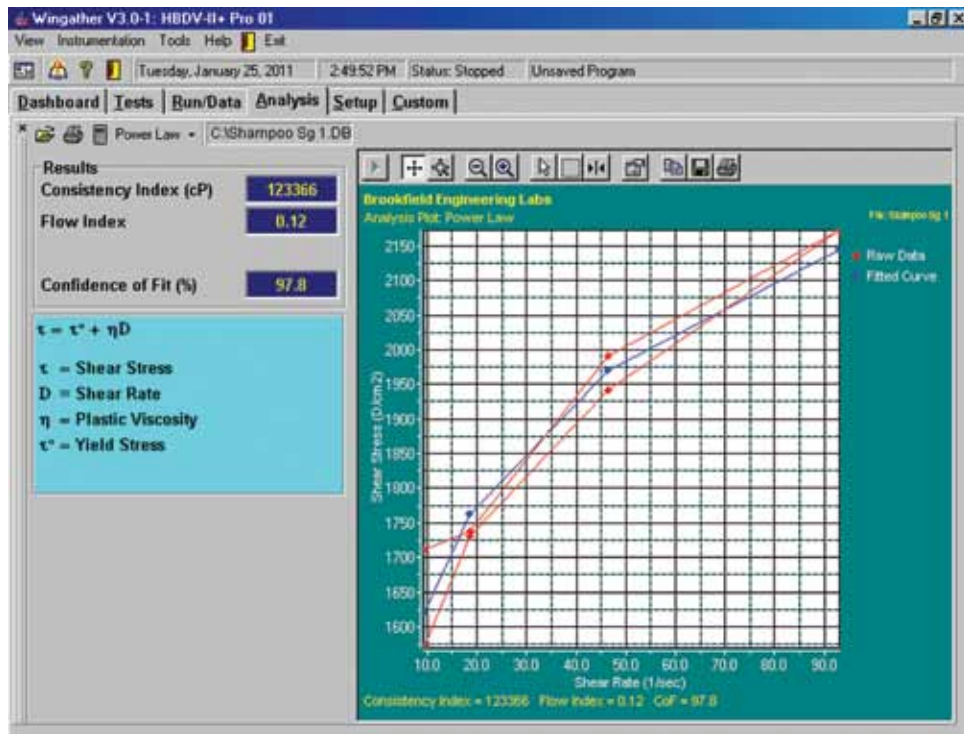

Figure VI-5: Analysis Screen

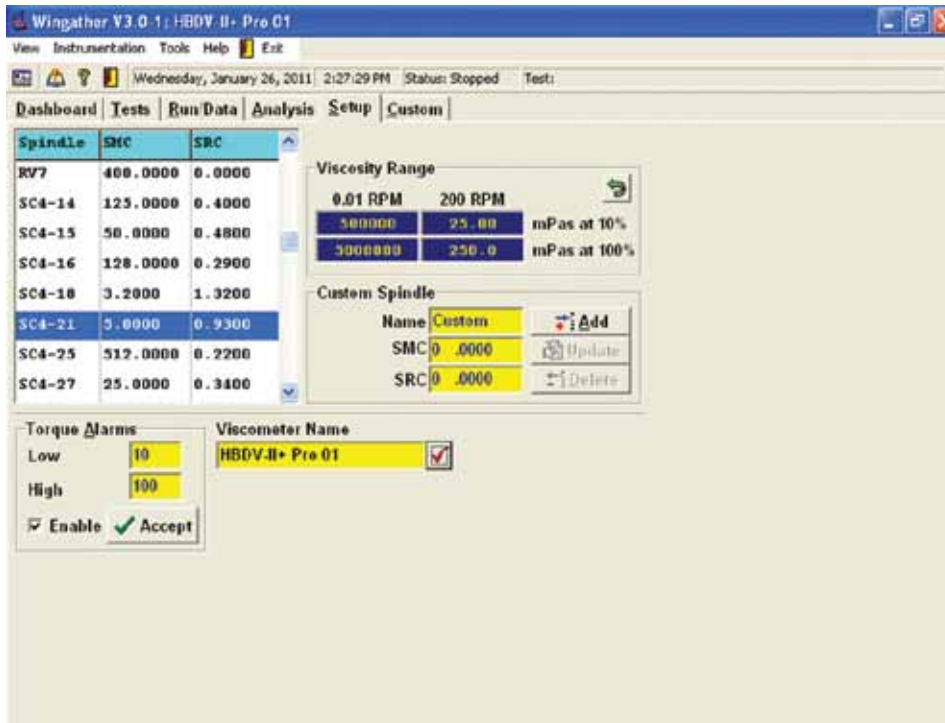

Figure VI-6: Setup Screen

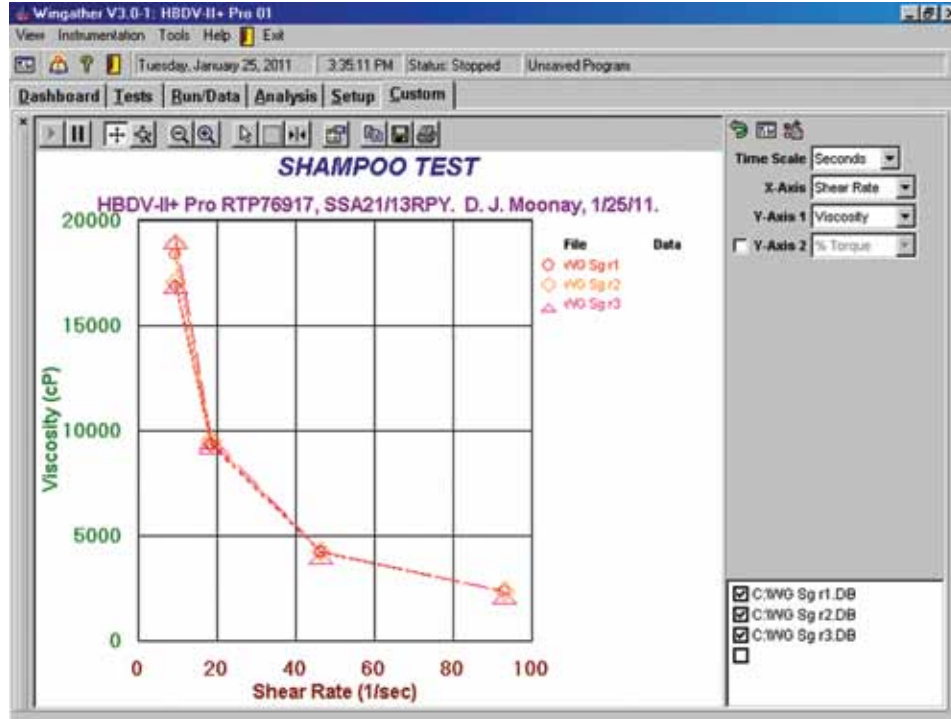

Figure VI-7: Custom Screen

## V1.2 Rheocalc

Important features and benefits in Rheocalc which enhance operator versatility in performing viscosity tests include the following:

- Rheocalc version 3.0 and higher are compatible with Windows™ 2000, NT, XP, Vista and Windows™ 7 operating systems for flexible operation
- Easy-to-use, structured command language to make viscosity tests easier to program
- Display of current temperature set point
- Concurrent plotting of four data sets on one graph
- Various mathematical models for data analysis
- Auto range feature which shows in screen display the complete viscosity range which can be measured at any shear rate for a specific spindle geometry

The following figures show the principal screens associated with Rheocalc:

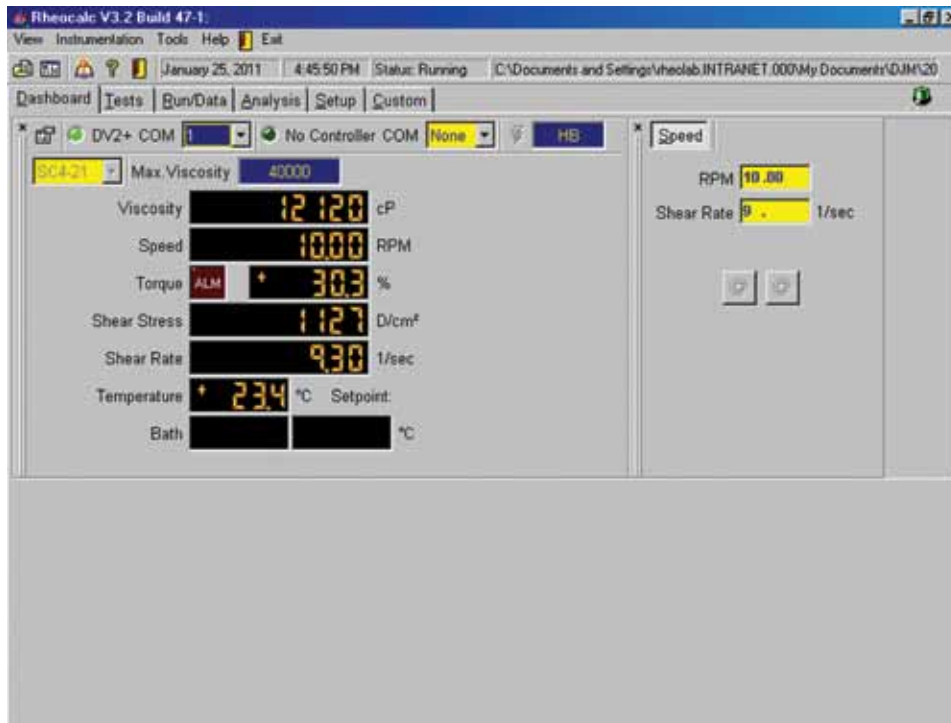

*Figure V1-8: Dashboard Screen*

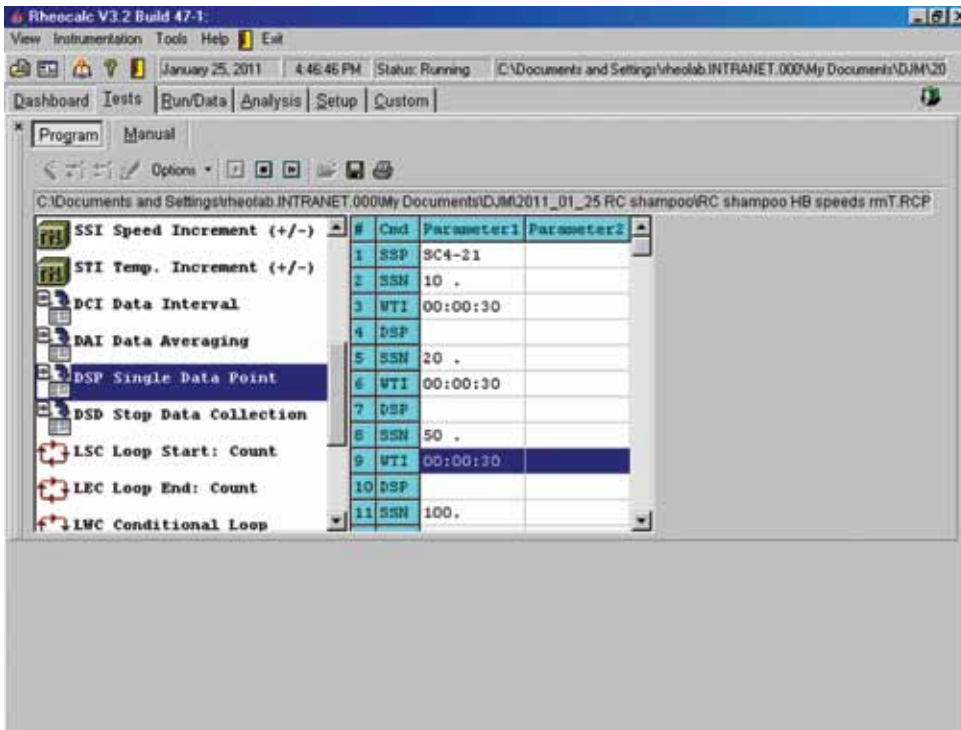

Figure V1-9: Test Screen

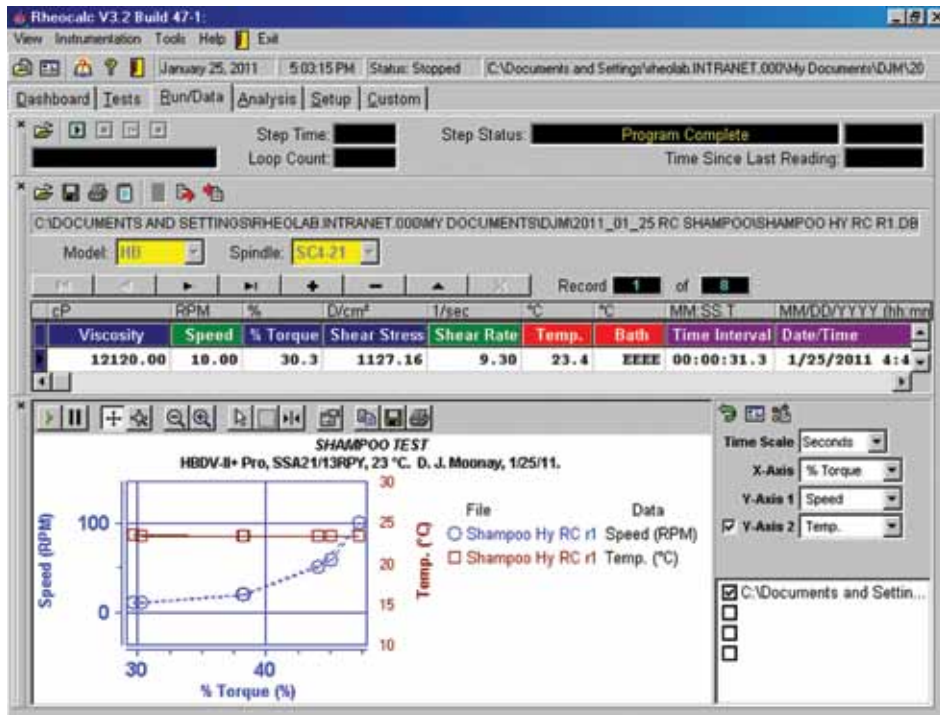

Figure V1-10: Run/Data Screen

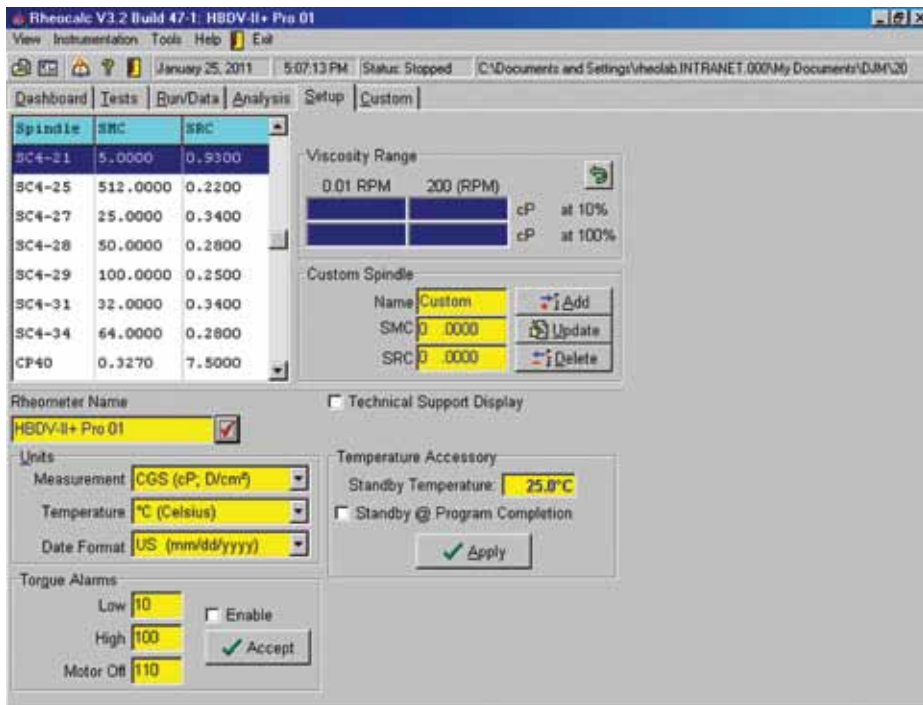

Figure V1-11: Setup Screen

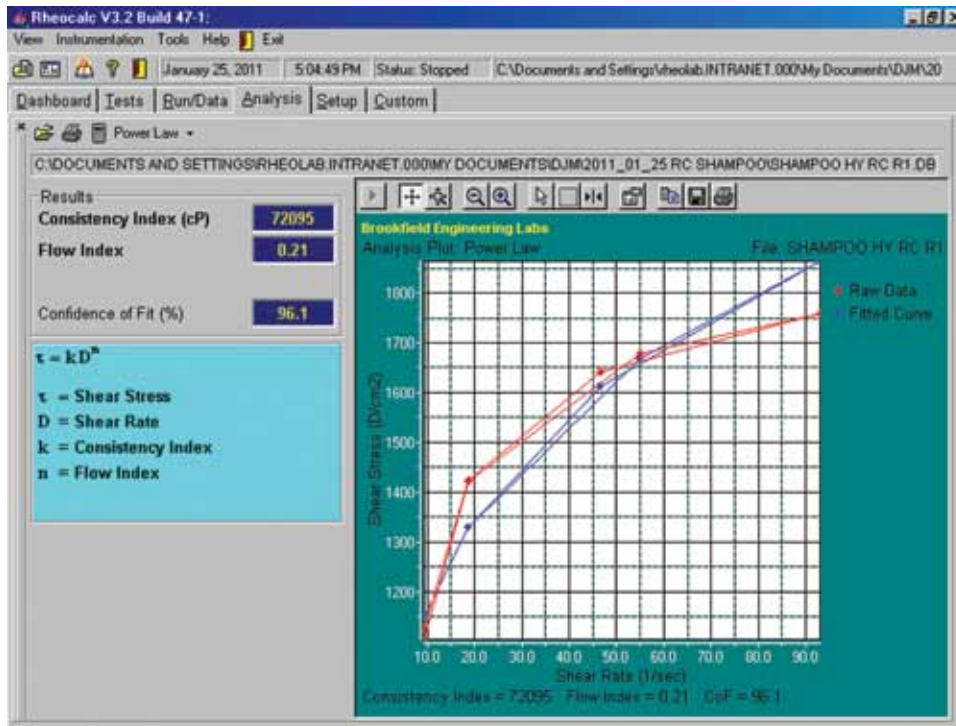
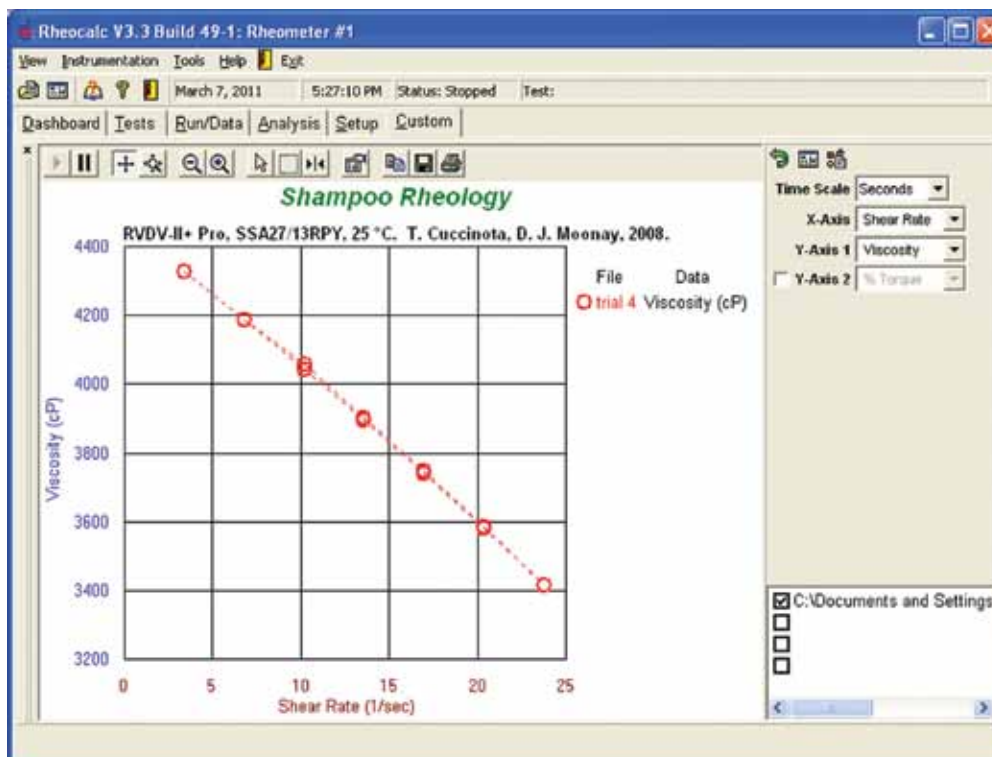

Figure V1-12: Analysis Screen



*Figure VI-13: Custom Screen*

### V1.3 Math Models

Note: Some or all of these models are available in Wingather or Rheocalc.

Math models provide parameters that indicate how materials will behave in various circumstances where shear stress and shear rate vary. The data and calculated model parameters can be used to help QC and R&D characterize how a product will behave for the customer and how it will behave during processing.

When selecting a math model, it is important to take into consideration the parameters that need to be measured, as well as, the confidence of fit (CoF). A CoF above 98 is recommended. This appendix discusses the parameters of the following four models, what kinds of materials they should be used with, and provides an example of each. All models discussed are available with Brookfield's Rheocalc™, Wingather™, and RHEO 3000™ software.

- Power Law (Ostwald)
- Herschel-Bulkley
- Bingham
- Casson

In addition to the above models, this appendix also briefly covers the NCA/CMA Casson model and the IPC Paste Model. These can be found at the end of this section.



### V1.3.1 The Power Law (Ostwald) Model

$$\tau = k\dot{\gamma}^n \quad (\tau = \text{shear stress, } k = \text{consistency index, } \dot{\gamma} = \text{shear rate, and } n = \text{flow index})$$

#### What does it tell you?

The Power Law model provides a consistency index,  $k$ , which is a product's viscosity at one reciprocal second. (Reciprocal seconds are the units of measurement for shear rate.) It also provides a flow index,  $n$ , which indicates the degree with which a material exhibits non-Newtonian flow behavior. Since Newtonian materials have linear shear stress vs. shear rate behavior and  $n$  describes the degree of non-Newtonian flow, the flow index essentially indicates how “non-linear” a material is.

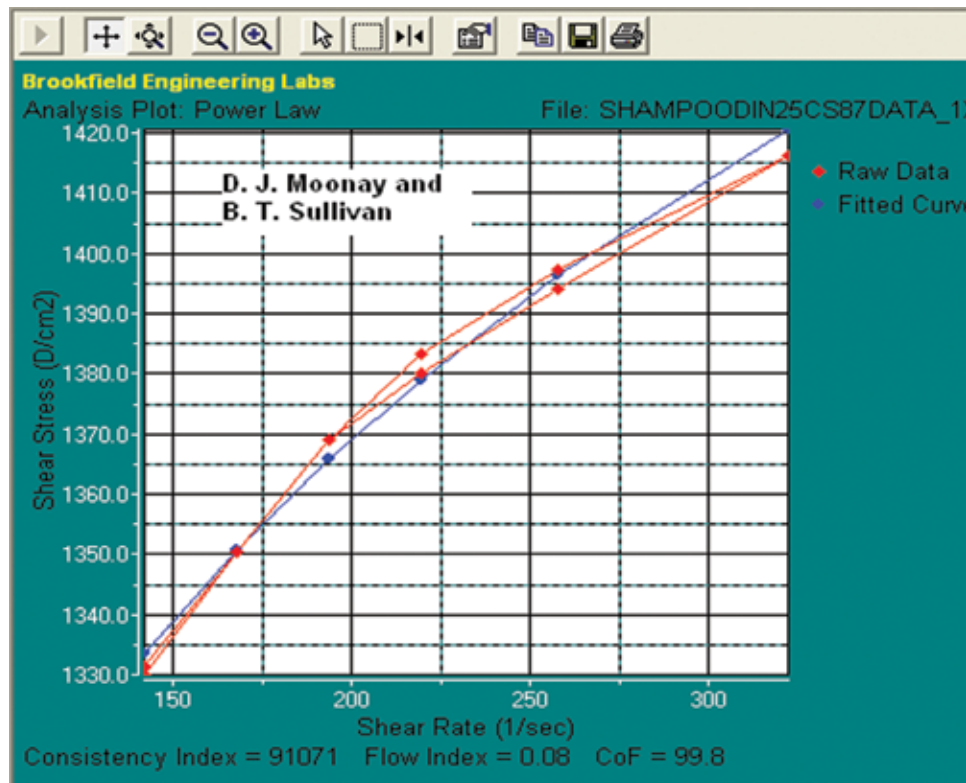

Figure V1-14

When  $n < 1$  the product is shear-thinning or Pseudoplastic. This means the apparent viscosity decreases as shear rate increases. The closer  $n$  is to 0, the more shear thinning the material is.

When  $n > 1$  the product is shear-thickening or Dilatant. Their apparent viscosity increases as shear rate increases.

#### When should you use it?

This model should be used with non-Newtonian, time-independent fluids that do not have a yield stress. These fluids will begin to flow under any amount of shear stress. Graphs of such material generally intersect the y-axis at 0.

### An Example of the Power Law Model at Work

Formulators at a personal care company would like to use a substitute ingredient to decrease cost. They use the Power Law model to evaluate the effect the new ingredient will have on the behavior of their shampoo. They need to know how it will behave during processing and how it will behave when it is being used by the consumer.

#### Shampoo

Flow Index ( $n$ ) = 0.08  
Consistency Index ( $k$ ) = 91071 cP

With the new ingredient the shampoo has a flow index ( $n$ ) of 0.08. This indicates that the shampoo is shear-thinning enough to flow properly during processing and that it will flow properly for the end-user. The consistency index,  $k$ , indicates how the shampoo behaves when it experiences low shear rates. The power law values show that the shampoo becomes quite thin at process shear rates and therefore it can be easily pumped into filling equipment, hold tanks, etc. The consistency index of 91,071 cP shows that the shampoo is very viscous at low shear rates, and as a result, it will appear to customers to be “rich and creamy” while still being easy to apply.

### V1.3.2 The Herschel-Bulkley Model

$$\tau = \tau_o + k\dot{\gamma}^n \quad (\tau_o = \text{shear stress}, \tau_o = \text{yield stress}, k = \text{consistency index}, \dot{\gamma} = \text{shear rate}, \text{ and } n = \text{flow index})$$

#### What does it tell you?

The Herschel-Bulkley model is simply the Power Law model with the addition of  $\tau_o$  for yield stress. Yield stress,  $\tau_o$ , denotes how much shear stress is required to initiate flow. This model also provides a consistency index,  $k$ , which is a product's viscosity at 1 reciprocal second, and a flow index,  $n$ , which indicates the degree with which a material exhibits non-Newtonian flow behavior. Since Newtonian materials have linear shear stress vs. shear rate behavior and  $n$  describes the degree of non-Newtonian flow, the flow index essentially indicates how “non-linear” a material is. For Herschel-Bulkley fluids,  $n$  will always be greater than or less than 1.

When  $n < 1$  the product is shear-thinning or Pseudoplastic. This means the apparent viscosity decreases as shear rate increases. The closer  $n$  is to 0, the more shear thinning the material is.

When  $n > 1$  the product is shear-thickening or Dilatant. Its apparent viscosity increases as shear rate increases.

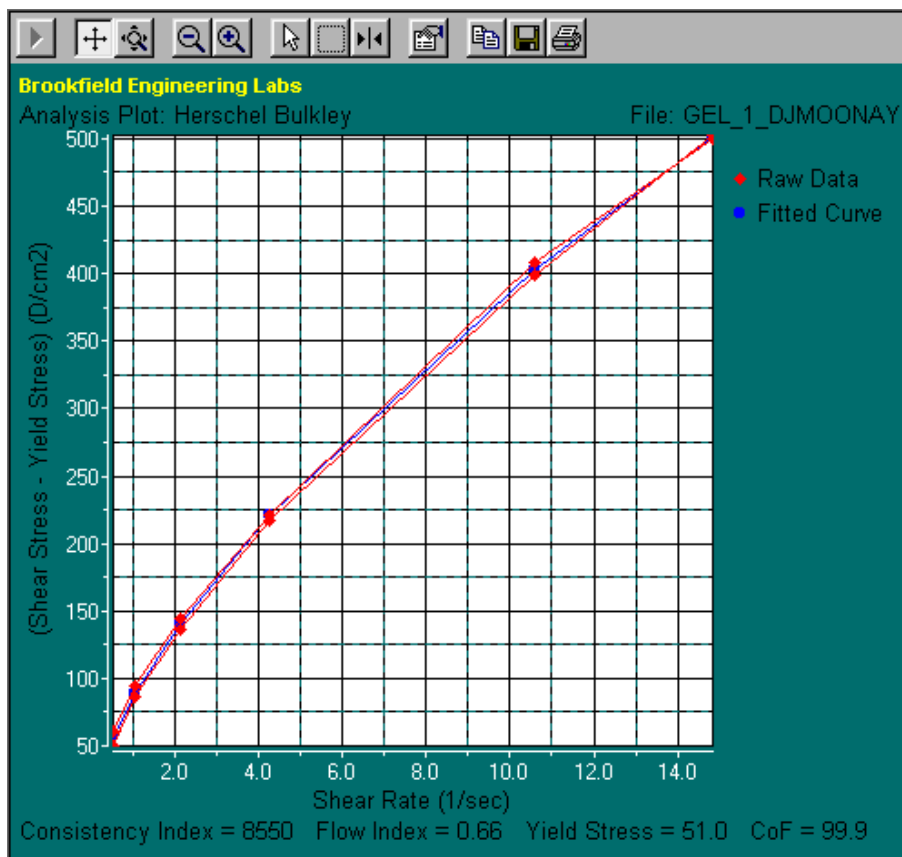

Figure VI-15

### When should you use it?

The Herschel-Bulkley model should be used with non-Newtonian, time-dependent materials that have a yield stress. Products with a yield stress only begin to flow after a certain amount of shear stress is applied. As a result, the flow curve intersects the y-axis at a point greater than 0. After yielding, the product creates a flow curve and behaves as a Power Law fluid so that  $n$  indicates where there is a shear-thinning or shear-thickening tendency. (In this case, if  $n = 1$ , the material is behaving as a Bingham fluid, which is discussed next.)

### An Example of the Herschel-Bulkley Model at Work

A company uses a gel-like substance as part of their production process. Upon arrival they test the material and apply the Herschel-Bulkley model to ensure it will perform correctly during process. The results in figure VI-2 show that the consistency index is 8,550 cP, the flow index is 0.66, and the yield stress is 51.0 dynes/cm<sup>2</sup>. These results indicate that this batch of gel does not quite meet specification. While the consistency index is within spec, the yield value is higher than normal so the fluid will not begin to flow as easily. With a flow index of 0.66, this batch is also less shear thinning than normal. Pump and mixer speeds must be adjusted before using this material.

#### Gel-Like Substance

$$\begin{aligned}
 n &= 0.66 \\
 \tau_o &= 51.0 \text{ dynes/cm}^2 \\
 k &= 8550 \text{ cP}
 \end{aligned}$$

### V1.3.3 The Bingham Model

$$\tau = \tau_0 + \eta D \quad (\tau = \text{shear stress, } \tau_0 = \text{yield stress, } \eta = \text{plastic viscosity, and } D = \text{shear rate})$$

#### What does it tell you?

The Bingham model indicates a product's yield stress,  $\tau_0$ , which is the amount of shear stress required to initiate flow. It also provides the plastic viscosity,  $\eta$ , which is the viscosity after a product yields.

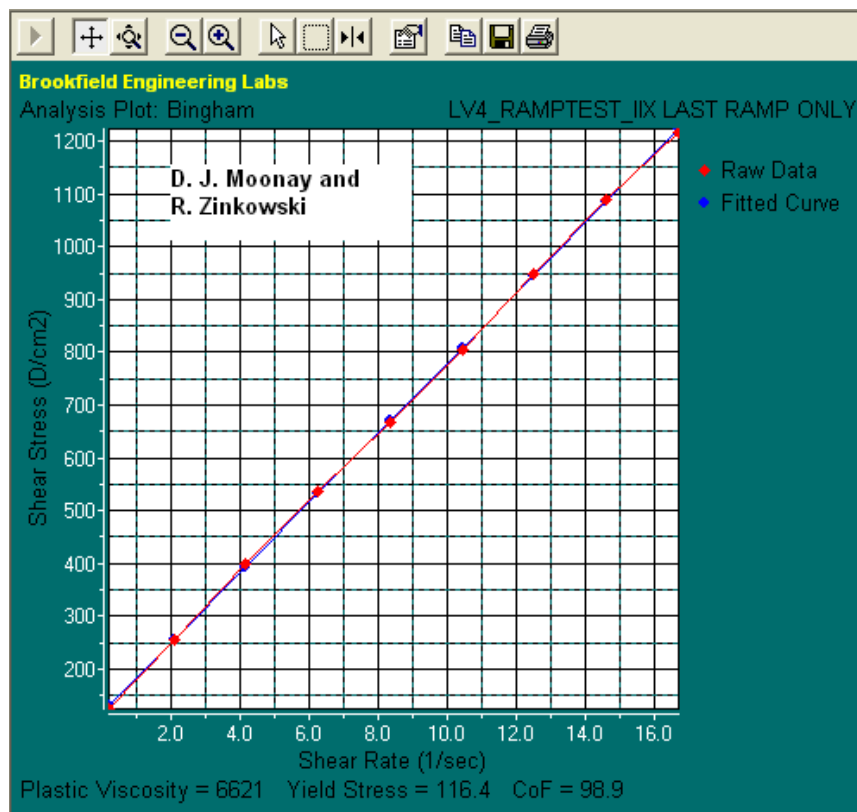

Figure V1-16

#### When should you use it?

This model should be used with non-Newtonian materials that have a yield stress and then behave in a Newtonian fashion once they begin to flow. As a result, the shear stress-shear rate plot forms a straight line after yielding. (Products that have a yield stress only begin to flow after a certain amount of shear stress is applied. They are also called “viscoplastic”. Their shear stress vs. shear rate graphs intersect the y-axis at a point greater than 0.)

### An Example of the Bingham Model at Work

A manufacturer of drilling fluid applies the Bingham Model to ensure the quality of their product. Results from a recent batch, shown in Figure VI-3, showed that the yield stress and plastic viscosity were both below the pass/fail criteria, which would cause the fluid to insufficiently hold-up the cuttings. The shipment was cancelled and the root-cause of the problem was identified.

#### Drilling Fluid

Plastic Viscosity ( $\eta$ ) = 6621 cP  
Yield Stress ( $\tau_o$ ) = 166.4 dynes/cm<sup>2</sup>

### V1.3.4 The Casson Model

$$\sqrt{\tau} = \sqrt{\tau_o} + \sqrt{\eta D} \quad (\tau = \text{shear stress, } \tau_o = \text{yield stress, } \eta = \text{plastic viscosity, and } D = \text{shear rate})$$

#### What does it tell you?

The Casson model provides parameters similar to that of the Bingham model. However, unlike the Bingham model, it was developed for materials that exhibit non-Newtonian flow after yielding. The Casson model indicates the product's yield stress ( $\tau_o$ ) which is the amount of shear stress required to initiate flow, and the product's plastic viscosity,  $n$ , which is the viscosity of the product after it yields.

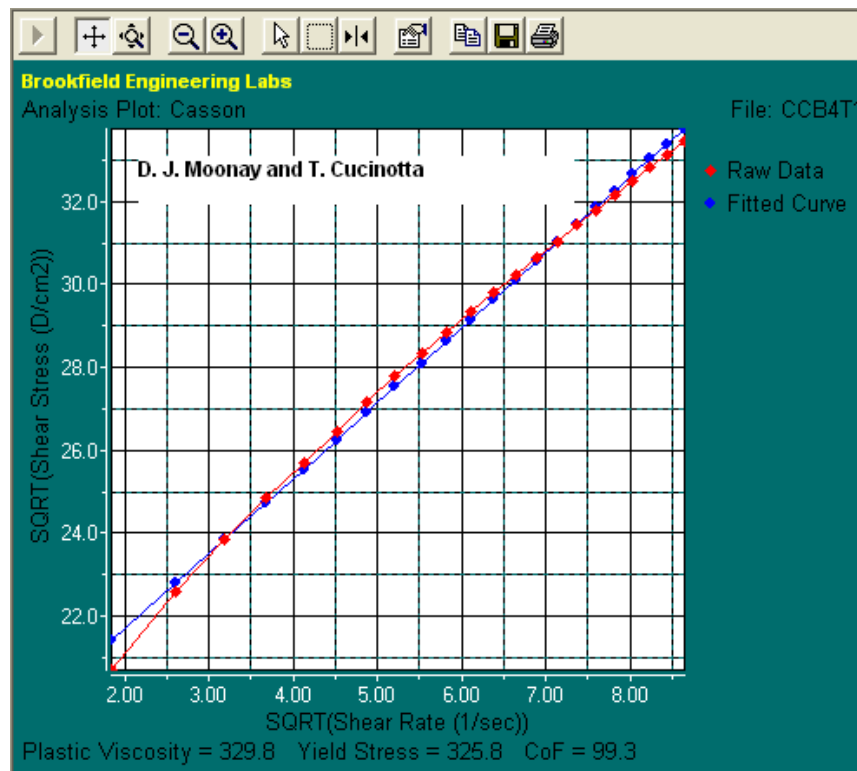

Figure V1-17

## When should you use it?

The Casson model should be used with non-Newtonian materials that have a yield stress and that do not exhibit a “Newtonian-like” behavior once they begin to flow. This model is most suitable for fluids that exhibit Pseudoplastic or shear thinning, flow behavior after yielding.

These fluids have a non-linear flow curve. The point at which it crosses the y-axis is the product’s yield stress ( $\tau_o$ ). To protect the point at which the curve will intersect with the y-axis, the Casson model linearizes or straightens the plot by taking the square root of the data. To ensure accurate extrapolation to yield stress it is best to take some data at low shear rates.

### An Example of the Casson Model at Work

Before releasing a new over the counter gel, a pharmaceutical company needs to learn how it will behave which it is being used by the end consumer. They perform a full viscosity profile and apply the Casson model. From the results, shown in Figure VI-4, they learn that their ointment has a higher yield stress,  $\tau_o$ , and lower plastic viscosity,  $n$ , than they originally intended.

As a result it is difficult or dispense from its container (due to the high yield stress) and it does not hold it shape very well (due to the low plastic viscosity), making it difficult to apply a small amount to the affected area of the skin. Based on this data, formulators are able to modify the ingredients accordingly. Once a formulation is established, multi-point tests and the Casson model are performed as a QC tool to check batches before and after processing.

#### Pharmaceutical Gel

Plastic Viscosity ( $\eta$ ) = 329.8 cP  
Yield Stress ( $\tau_o$ ) = 325.8 dynes/cm<sup>2</sup>

### V1.3.5 Other Common Rheological Models

#### The NCA/CMA Casson Model

$$(1 + a) \sqrt{\tau} = 2\sqrt{\tau_o} + (1 + a) \sqrt{\eta\dot{\gamma}} \quad (\tau = \text{shear stress, } \tau_o = \text{yield stress, } \eta = \text{plastic viscosity, and } \dot{\gamma} = \text{shear rate})$$

The NCA/CMA Casson model is designed by the National Confectioners Association and the Chocolate Manufacturers Association as the standard rheological model for the industry. This model determines yield and flow properties under specified conditions and closely approximates the plastic behavior of chocolate before final processing.

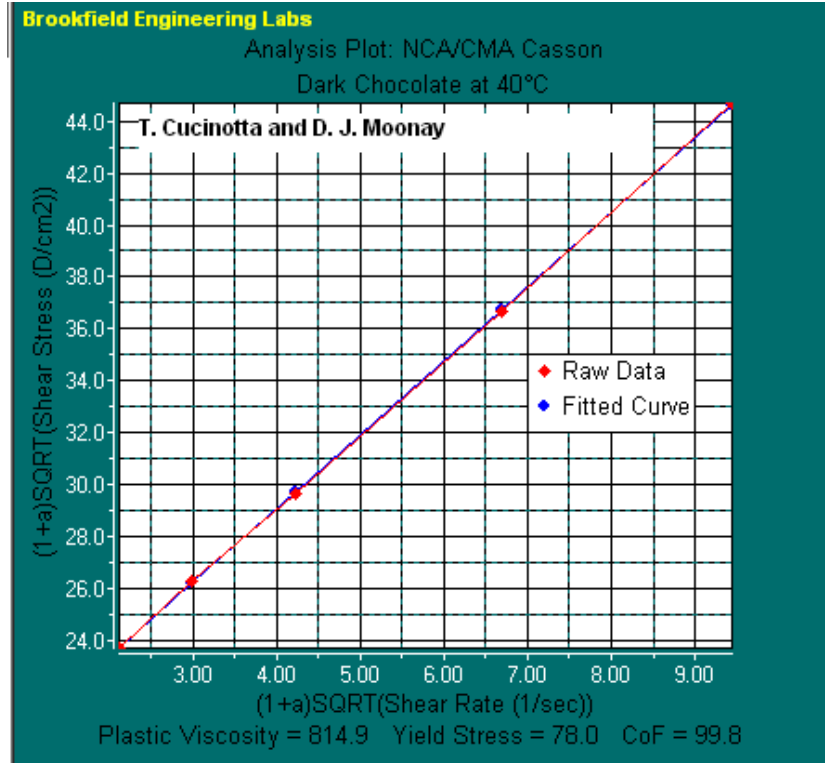

Figure VI-18

When chocolate is used for enrobing, it must have a yield stress high enough to stay in place once it enrobes the filling. In the case of decorating chocolate, the yield stress must be high enough so it can keep its shape once it has been squeezed into place through a nozzle. For molding chocolate, the plastic viscosity must be low enough to completely fill the mold.

(The NCA/CMA lists Brookfield's HA-spring range viscometer with a Small Sample Adapter, SC4-27 spindle and SC4-13R sample chamber as the approved apparatus.)

#### The IPC Paste Model

$$\eta = kR^n$$

The IPC Paste Model was developed for solder pastes. It calculates the viscosity of solder pastes at 10rpm. The IPC Paste Model requires that the product be tested with a Brookfield Spiral Adapter at multiple speeds. More details can be found in the IPC-TM-650 Test Methods Manual (methods 2.4.34.2 and 2.4.3).

This model is a variation of the Power Law Model. Unlike the Power Law Model, which relates apparent viscosity to shear rate, the IPC Paste Model relates apparent viscosity to the testing speed (rpm).

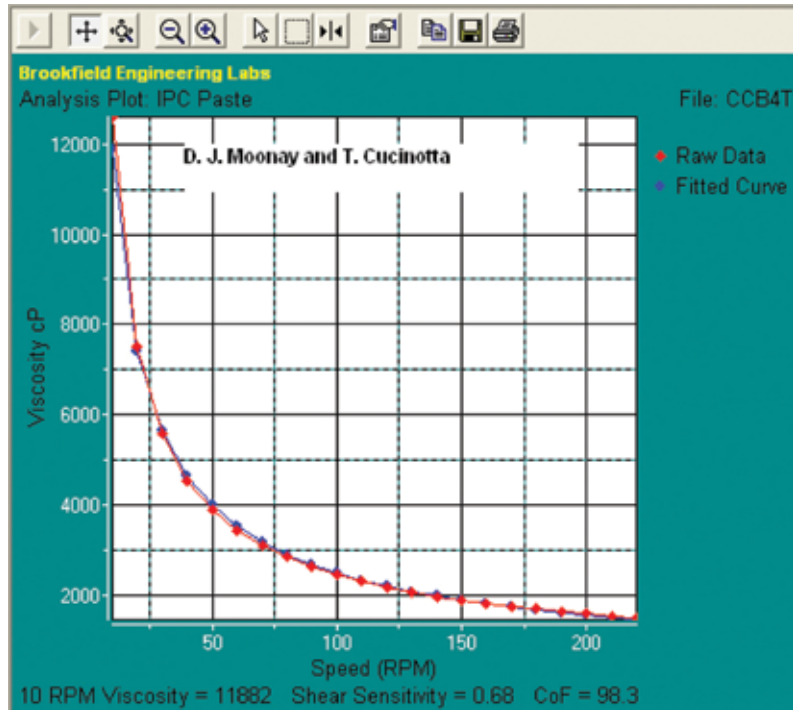

Figure VI-20

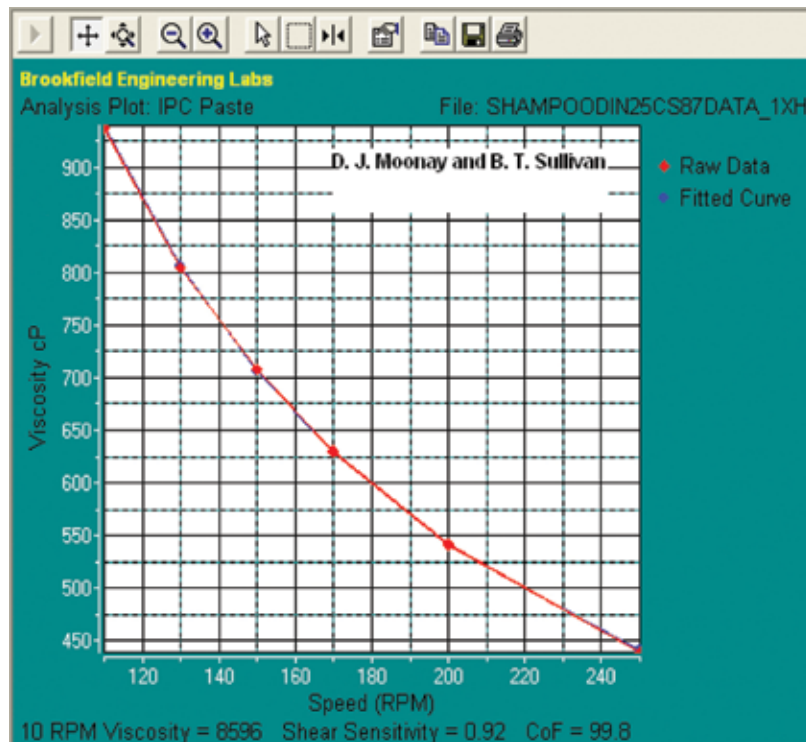

Figure VI-21



## Appendix A - Cone/Plate Viscometer Set-Up

This Cone/Plate version of the DV-II+Pro uses the same operating instruction procedures as described in this manual. However, the “gap” between the cone and the plate must be verified/adjusted before measurements are made. This is done by moving the plate (built into the sample cup) up towards the cone until the pin in the center of the cone touches the surface of the plate, and then by separating (lowering) the plate 0.0005 inch (0.013mm).

When operating the Cone/Plate at elevated temperature, the gap must be set with the cup and spindle equilibrated at the temperature recommended. Maximum temperature for Cone/Plate operation is 80°C. Maximum operational temperature of sample cup is 100°C. Personal protection is recommended when controlling to temperatures above 80°C.



*Note:* Mic ring will become hot when controlling sample cup at temperatures above 50°C.

Programmable DV-II+Pro Cone/Plate Viscometers, S/N 50969 and higher, have an Electronic Gap Setting feature. This feature enables the user to easily find the 0.0005 inch gap setting that was established at Brookfield prior to shipment.

The following information explains how to set the Electronic Gap and verify calibration of the DV-II+Pro Viscometer.

### A.1 Electronic Gap Setting Features

**TOGGLE SWITCH** allows you to enable/disable the Electronic Gap Setting Feature: left position is OFF (disabled), right position is ON (enabled).

**PILOT LIGHT** is the red (LED) light; when illuminated, it means the Electronic Setting Function is sensing (enabled).



*Note:* Be sure the light is off before introducing the test sample.

**CONTACT LIGHT** is the yellow (LED) light; when it first turns on, the “hit point” has been found.

**SLIDING REFERENCE MARKER** is used after finding the “hit point;” it is the reference for establishing the 0.0005 inch gap.

**MICROMETER ADJUSTMENT RING** is used to move the cup up or down in relation to the cone spindle. Turning the ring left (clockwise) lowers the cup; turning it right (counterclockwise) raises the cup. Each line on the ring represents one scale division and is equivalent to 0.0005 inch movement of the plate relative to the cone.

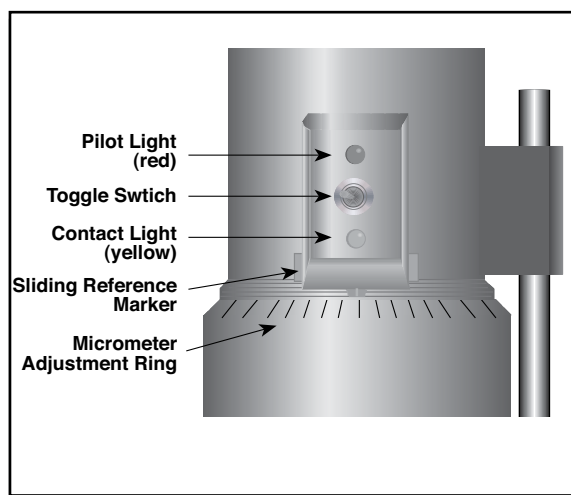
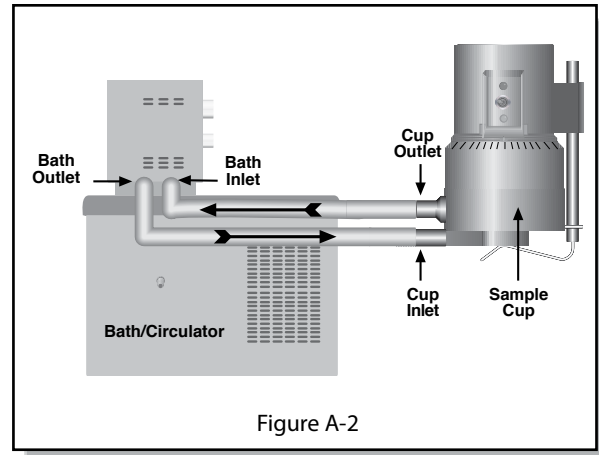

Figure A-1

## A.2 Setup

1. Be sure that the Viscometer is securely mounted to the Laboratory Stand, leveled and zeroed with no cone or cup attached and 0% torque is displayed.
2. **Figure A-2** shows a typical water bath setup. Connect the sample cup inlet/outlet ports to the water bath inlet and outlet and set the bath to the desired test temperature. Allow sufficient time for the bath to reach the test temperature.



3. The Viscometer has been supplied with a special cone spindle(s) which contains the Electronic Gap Setting feature. The “CPE” or “CPA” part number designation on the cone spindle verifies the Electronic Gap Setting feature.

*Note:* The “CPE” or “CPA” cone or cup cannot be used with earlier DV-II+ cone/plate Viscometers (below S/ N50969) which do not have the electronic gap setting feature.

4. With the motor off, thread the cone spindle by using the spindle wrench to secure the viscometer coupling nut (see **Figure A-3**); gently push up on the coupling nut and hold this securely with the wrench. Thread the cone spindle by hand.

*Note:* Left Hand Threads.

5. Attach the cup, taking care not to hit the cone with the cup (**Figure A-4**), by positioning the cup against the mic ring and swinging the tension bar under the cup. The tension bar should have plastic tubing in place.

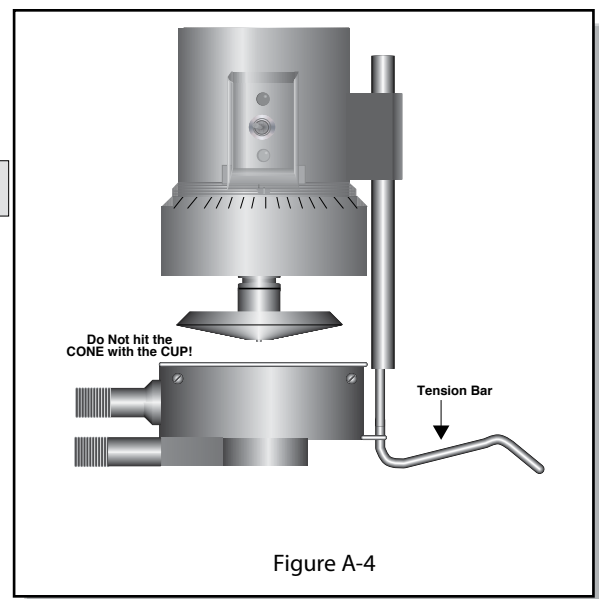
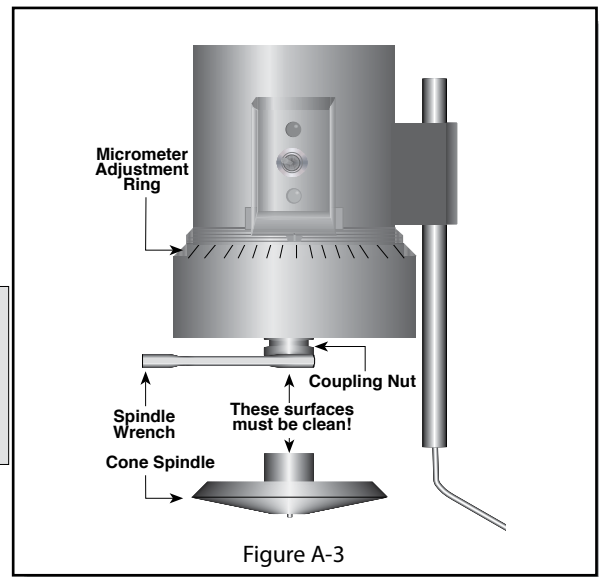

### A.3 Setting the Gap

1. Move the toggle switch to the right; this will turn on (enable) the Gap Setting Feature. The Pilot (red) light will be illuminated.  
**Note: The motor should be OFF.**
2. If the contact light (yellow) is illuminated, turn the micrometer adjustment ring clockwise (as you look down on the instrument) until the light is no longer illuminated (see **Figure A-5**).
3. If the yellow contact light is not illuminated, *slowly* turn the micrometer adjustment ring in small increments (one or two scale divisions) counter-clockwise.

Continue moving the micrometer adjustment ring *slowly* counter-clockwise until the contact light (yellow) first turns on. **THIS IS THE “HIT POINT.”**

4. Adjust the sliding reference marker, right or left, to the closest full scale division mark (see **Figure A-6**).
5. Turn the micrometer adjustment ring one scale division to the left to meet the line on the sliding reference marker. **THE YELLOW CONTACT LIGHT SHOULD GO OFF.**
6. You have established the gap space needed for measurement. Now turn the toggle switch OFF (left); the red pilot light should go off.

The viscosity of electrically conductive fluids may be affected if readings are taken with the Electronic Gap Setting feature “on”. Be sure to shut the feature “off” before taking readings!

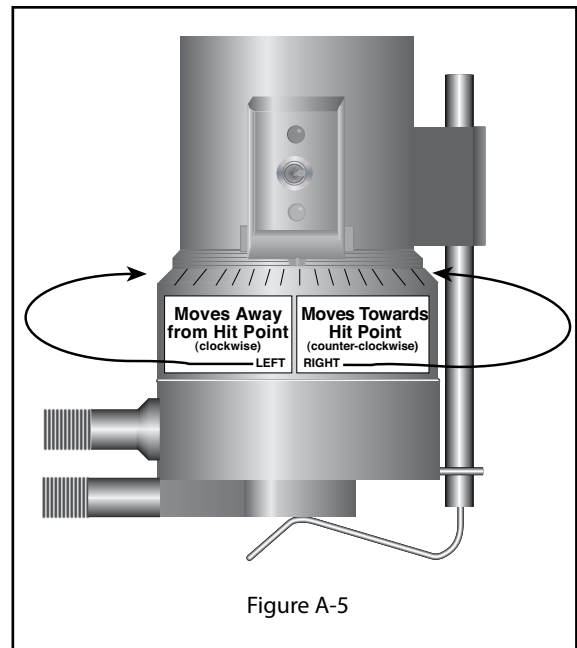

Figure A-5

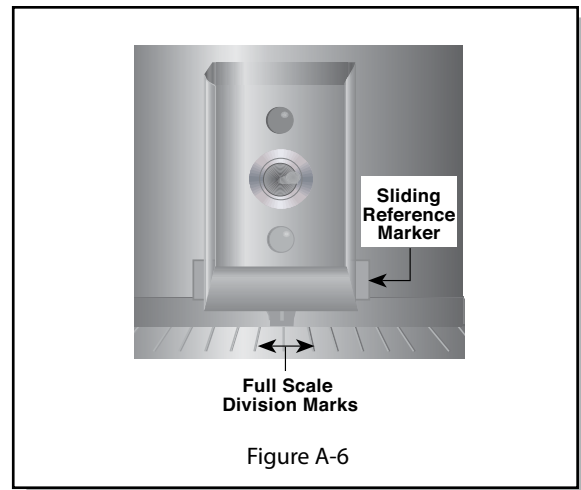

Figure A-6

7. Carefully remove the sample cup.

*Note:*

1. The cup may be removed and replaced without resetting the gap if the micrometer adjustment ring has not been moved.
2. Remove the spindle from the viscometer when cleaning.
3. Re-establish the hit point every time the spindle is attached/detached.

## A.4 Verifying Calibration

1. Determine the appropriate sample volume. Refer to Table A-1 to determine the correct sample volume required for the spindle to be utilized.
2. Select a Brookfield Viscosity Standard fluid that will give viscosity readings between 10% and 100% of full scale range. Refer to **Appendix B** for viscosity ranges of cone spindles.

Brookfield uses mineral oil viscosity standard fluids to calibrate Wells Brookfield Cone/Plate Viscometers at the factory. Brookfield recommends that customers use mineral oil viscosity standard fluids when you perform a calibration check.

If you decide to use a silicone viscosity standard fluid, do not use a fluid with a viscosity value greater than 5000 cP with a Cone/Plate. Brookfield offers a complete range of mineral oil viscosity standards suitable for use with Cone/Plates for viscosities above 5,000 cP or shear rates above 500 sec<sup>-1</sup>; see Table E-2 in Appendix E for a list of available fluids.

It is best to use a viscosity standard fluid that will be close to the maximum viscosity for a given cone spindle/speed combination.

**Example:** LVDV-II+ Pro Viscometer, Cone Spindle CPA-42Z, Brookfield Silicone Viscosity Standard having a viscosity of 9.7 cP at 25°C

At 60 RPM, the full scale viscosity range is 10.0 cP. Thus, the Viscometer reading should be 97% torque and 9.7 cP viscosity  $\pm 0.197$  cP. The allowable error ( $\pm 0.197$  cP) is a combination of Viscometer accuracy and fluid tolerance (refer to **Interpretation of Calibration Test Results** in Appendix E).

3. With the motor off, remove the sample cup and place the viscosity standard fluid into the cup.

Cone Part No.	Sample Volume
CPA-40Z, CPE-40, CP-40	0.5 mL
CPA-41Z, CPE-41, CP-41	2.0 mL
CPA-42Z, CPE-42, CP-42	1.0 mL
CPA-51Z, CPE-51, CP-51	0.5 mL
CPA-52Z, CPE-52, CP-52	0.5 mL

4. Attach the sample cup to the Viscometer and allow sufficient time for the sample, cup and cone to reach temperature equilibrium.
5. Turn the motor on. Set the desired speed(s). Measure the viscosity and record the reading in both % torque and centipoise (cP).
6. Verify that the viscosity reading is within the allowable 1% deviation, as explained earlier, for the specific viscosity standard fluid(s) that you are using.

The CPE or CPA designation on the cone spindle indicates use with Electronic Gap Setting Cone/Plate Viscometers/Rheometers **only**.

## Appendix B - Viscosity Ranges

### Viscosity Range Tables

Viscosity ranges shown are for operational speeds 0.1 through 200 rpm.

#### LV Viscometer with LV spindles #1-4 and RV/HA/HB Viscometers with spindles #1-7

Viscosity Range (cP)		
Viscometer	Minimum	Maximum
LVDV-II+	15	6,000,000
RVDV-II+	100	40,000,000
HADV-II+	200	80,000,000
HBDV-II+	800	320,000,000

#### Small Sample Adapter and Thermosel

SSA and Thermosel Spindle	Viscosity (cP)				Shear Rate sec <sup>-1</sup> ↺
	LVDV-II+	RVDV-II+	HADV-II+	HBDV-II+	
Ⓢ SC4-14	58.6 - 1,171.00	625 -12,500,000	1,250 - 25,000,000	5,000 - 100,000,000	.40N
Ⓢ SC4-15	23.4 - 468,650	250 - 5,000,000	500 - 10,000,000	2,000 - 40,000,000	.48N
Ⓢ SC4-16	60 - 1,199,700	640 -12,800,000	1,280 - 25,600,000	5,120 - 102,400,000	.29N
SC4-18	1.5 - 30,000	16 - 320,000	32 - 640,000	128 - 2,560,000	1.32N
SC4-21	2.4 - 46,865	25 - 500,000	50 - 1,000,000	200 - 4,000,000	.93N
SC4-25	240 - 4,790,000	2,560 -51,200,000	5,120 -102,400,000	20,480 -409,600,000	.22N
SC4-27	11.7 - 234,325	125 - 2,500,000	250 - 5,000,000	1,000 - 20,000,000	.34N
SC4-28	23.4 - 468,650	250 - 5,000,000	500 - 10,000,000	2,000 - 40,000,000	.28N
SC4-29	46.9 - 937,300	500 -10,000,000	1,000 - 20,000,000	4,000 - 80,000,000	.25N
SC4-31	15 - 300,000	160 - 3,200,000	320 - 6,400,000	1,280 - 25,600,000	.34N
SC4-34	30 - 600,000	320 - 6,400,000	640 - 12,800,000	2,560 - 51,200,000	.28N
Ⓣ HT-DIN-81	3.4 - 10,000	36.5 - 10,000	73 - 10,000	292 - 10,000	1.29N
Ⓢ SC4-DIN-82	3.4 - 10,000	36.5 - 10,000	73 - 10,000	292 - 10,000	1.29N
Ⓢ SC4-DIN-83	11.3 - 37,898	121.3 - 50,000	242.6 - 50,000	970.4 - 50,000	1.29N

Ⓣ This spindle used with Thermosel only

Ⓢ This spindle used with Small Sample Adapter only

↺ N represents speed in RPM. For example, spindle SC4-14 operated at 5 rpm has a shear rate of  $0.40 \times 5 = 2.0 \text{ sec}^{-1}$

## UL Adapter

UL Spindle	Viscosity (cP)				Shear Rate sec-1
	LVDV-II+	RVDV-II+	HADV-II+	HBDV-II+	
YULA-15 or 15Z	1 - 2,000	3.2 - 2,000	6.4 - 2,000	25.6 - 2,000	1.22N

## DIN Adapter Accessory

DAA Spindle	Viscosity (cP)				Shear Rate sec-1
	LVDV-II+	RVDV-II+	HADV-II+	HBDV-II+	
85	0.6 - 5,000	6.1 - 5,000	12.2 - 5,000	48.8 - 5,000	1.29N
86	1.8 - 10,000	18.2 - 10,000	36.5 - 10,000	146 - 10,000	1.29N
87	5.7 - 50,000	61 - 50,000	121 - 50,000	485 - 50,000	1.29N

## Spiral Adapter

Spiral Spindle	Viscosity (cP)				Shear Rate sec-1
	LVDV-II+	RVDV-II+	HADV-II+	HBDV-II+	
SA-70	98 - 98,500	1,050 - 1,050,000	2,100 - 2,100,000	8,400 - 8,400,000	0.667N

## Cone/Plate Viscometer

Cone Spindle	Viscosity (cP)				Shear Rate sec-1
	LVDV-II+	RVDV-II+	HADV-II+	HBDV-II+	
CPA-40Z	.15 - 3,065	1.7 - 32,700	3.3 - 65,400	13.1 - 261,000	7.5N
CPA-41Z	.58 - 11,510	6.2 - 122,800	12.3 - 245,600	49.1 - 982,400	2.0N
CPA-42Z	.3 - 6,000	3.2 - 64,000	6.4 - 128,000	25.6 - 512,000	3.84N
CPA-51Z	2.4 - 47,990	25.6 - 512,000	51.7 - 1,024,000	205 - 4,096,000	3.84N
CPA-52Z	4.6 - 92,130	49.2 - 983,000	99.2 - 1,966,000	393 - 7,864,000	2.0N

## Helipath with T-Bar Spindle

T-Bar Spindle	Viscosity (cP)				Shear Rate sec-1
	LVDV-II+	RVDV-II+	HADV-II+	HBDV-II+	
T-A	156 - 187,460	2,000 - 2,000,000	4,000 - 4,000,000	16,000 - 16,000,000	
T-B	312 - 374,920	4,000 - 4,000,000	8,000 - 8,000,000	32,000 - 32,000,000	
T-C	780 - 937,300	10,000 - 10,000,000	20,000 - 20,000,000	80,000 - 80,000,000	
T-D	1,560 - 1,874,600	20,000 - 20,000,000	40,000 - 40,000,000	160,000 - 160,000,000	
T-E	3,900 - 4,686,500	50,000 - 50,000,000	100,000 - 100,000,000	400,000 - 400,000,000	
T-F	7,800 - 9,373,000	100,000 - 100,000,000	200,000 - 200,000,000	800,000 - 800,000,000	

## Vane Spindles

Spindle	Torque Range	Shear Stress Range (Pa)	Viscosity Range cP (mPa•s)
V-71	NOT RECOMMENDED FOR USE ON LV TORQUE		
V-72	LV	.188-1.88	104.04-1.04K
V-73	LV	.938-9.38	502-5.02K
V-74	LV	9.38-93.8	5.09K-50.9K
V-75	LV	3.75-37.5	1.996K-19.96K
V-71	RV	.5-5	262-2.62K
V-72	RV	2-20	1.11K-11.1K
V-73	RV	10-100	5.35K-53.5K
V-74	RV	100-1K	54.3K-543K
V-75	RV	40-400	21.3K-213K
V-71	HA	1-10	524-5.24K
V-72	HA	4-40	2.22K-22.2K
V-73	HA	20-200	10.7K-107K
V-74	HA	200-2K	108.6K-1.086M
V-75	HA	80-800	42.6K-426K
V-71	HB	4-40	2.096K-20.96K
V-72	HB	16-160	8.88K-88.8K
V-73	HB	80-800	42.8K-428K
V-74	HB	800-8K	434.4K-4.344M
V-75	HB	320-3.2K	170.4K-1.704M
V-71	5XHB	20-200	10.48K-104.8K
V-72	5xHB	80-800	44.4K-444K
V-73	5XHB	400-4000	214K-2.14M
V-74	5xHB	4K-40K	2.172M-21.72M
V-75	5xHB	1.6K-16K	852K-8.52M

- Note:**
- 1 Pa = 10 dyne/cm<sup>2</sup>
  - Viscosity Range is given at rotational speed of 10 RPM
  - 5xHB is the highest torque range available
  - Not for use with DV-E Viscometers

M = 1 million  
 K = 1 thousand  
 Pa = Pascal  
 cP = Centipoise  
 mPa•s = Millipascal•seconds

## Special Considerations

In taking viscosity measurements with the DV-II+Pro Viscometer there are two considerations which pertain to the low viscosity limit of effective measurement.

- 1) Viscosity measurements should be accepted within the equivalent % Torque Range from 10% to 100% for any combination of spindle/speed rotation.
- 2) Viscosity measurements should be taken under laminar flow conditions, not under turbulent flow conditions.

The first consideration has to do with the precision of the instrument. All DV-II+Pro Viscometers have an accuracy of +/- 1% of the range in use for any standard spindle or cone/plate spindle. (Note that accuracy values may be higher than 1% when using accessory devices with the DV-II+Pro). We discourage taking readings below 10% of range because the potential viscosity error of +/- 1% is a relatively high number compared to the instrument reading.

The second consideration involves the mechanics of fluid flow. All rheological measurements of fluid flow properties should be made under laminar flow conditions. Laminar flow is flow wherein all particle movement is in layers directed by the shearing force. For rotational systems, this means all fluid movement must be circumferential. When the inertial forces on the fluid become too great, the fluid can break into turbulent flow wherein the movement of fluid particles becomes random and the flow can not be analyzed with standard math models. This turbulence creates a falsely high Viscometer reading with the degree of non-linear increase in reading being directly related to the degree of turbulence in the fluid.

For the following geometries, we have found that an approximate transition point to turbulent flow occurs:

- |                      |                   |
|----------------------|-------------------|
| 1) No. 1 LV Spindle: | 15 cP at 60 RPM   |
| 2) No. 2 LV Spindle: | 100 cP at 200 RPM |
| 3) No. 1 RV Spindle: | 100 cP at 50 RPM  |
| 4) UL Adapter:       | 0.85 cP at 60 RPM |

Turbulent conditions will exist in these situations whenever the RPM/cP ratio exceeds the values listed above.

## Effect on accuracy when using accessory devices

The Brookfield viscometer has a stated accuracy of +/- 1% of the range in use. This stated accuracy applies when the viscometer is used in accordance with the operating instructions detailed in the instrument instruction manual and the calibration test fluid is used in accordance with the instructions provided by the fluid supplier (including the critical parameters of temperature control and stated fluid accuracy). Brookfield's accuracy statement of +/- 1% of the range in use applies to the Brookfield rotational viscometer when used with the standard spindles supplied with the instrument, including LV spindles 1 through 4 (supplied with LV series viscometers), RV spindles 2 through 7 (supplied with RV series viscometers), and HV series spindles 2 through 7 (supplied with HA series viscometers and HB series viscometers) in a 600 ML low form Griffin beaker.

Brookfield offers a range of accessories for use with the Brookfield viscometer to accommodate special measurement circumstances. These accessories, while offering added capability to the user, also contribute to an expanded measurement tolerance beyond the instrument accuracy of +/- 1% of the range in use. This expanded measurement tolerance is a function of many parameters including spindle geometry, accessory alignment accuracy, sample volume requirement, and



sample introduction techniques. The effect of these elements on measurement tolerance must be considered when verifying the calibration of your Brookfield viscometer. Sample temperature in all test circumstances is very important, and will also add an additional expanded tolerance depending on the temperature control system and the calibration verification tests begin with the standard viscometer spindles as detailed above. Once the calibration of the viscometer itself is confirmed, the expanded tolerance of the measurement system may be determined using accessory devices. In many cases this additional tolerance will be very minimal, but as a general statement, the addition of +/- 1% of the range in use is reasonable for accessories.

## Appendix C - Variables in Viscosity Measurements

As with any instrument measurement, there are variables that can affect a Viscometer measurement. These variables may be related to the instrument (Viscometer), or the test fluid. Variables related to the test fluid deal with the rheological properties of the fluid, while instrument variables would include the Viscometer design and the spindle geometry system utilized.

### Rheological Properties

Fluids have different rheological characteristics that can be described by Viscometer measurements. We can then work with these fluids to suit our lab or process conditions.

There are two categories of fluids:

#### Newtonian

- These fluids have the same viscosity at different Shear Rates (different RPMs) and are called Newtonian over the Shear Rate range they are measured.

#### Non-Newtonian

- These fluids have different viscosities at different shear rates (different RPMs). They fall into two groups:
  - 1) Time Independent non-Newtonian
  - 2) Time Dependent non-Newtonian

#### Time Independent

##### Pseudoplastic

- A pseudoplastic material displays a decrease in viscosity with an increase in shear rate, and is also known as “shear thinning”. If you take Viscometer readings from a low to a high RPM and then back to the low RPM, and the readings fall upon themselves, the material is time independent pseudoplastic (shear thinning).

#### Time Dependent

##### Thixotropic

- A thixotropic material has decreasing viscosity under constant shear rate. If you set a Viscometer at a constant speed recording cP values over time and find that the cP values decrease with time, the material is thixotropic.
- If you take viscometer readings from a low RPM to a high RPM and then back to the low RPM, and the readings are lower for the descending step, the material is time dependant, thixotropic.

Brookfield publication, “*More Solutions to Sticky Problems*” includes a more detailed discussion of rheological properties and non-Newtonian behavior.

### Viscometer Related Variables

Most fluid viscosities are found to be non-Newtonian. They are dependent on Shear Rate, time of test and the spindle geometry conditions. The specifications of the Viscometer spindle and chamber geometry will affect the viscosity readings. If one reading is taken at 2.5 rpm, and a second at 50 rpm, the two cP values produced will be different because the readings were made at different shear rates. The faster the spindle speed, the higher the shear rate.

The shear rate of a given measurement is determined by: the rotational speed of the spindle, the size and shape of the spindle, the size and shape of the container used and therefore the distance between the container wall and the spindle surface.

A repeatable viscosity test should control or specify the following:

- 1) Test temperature
- 2) Sample container size (or spindle/chamber geometry)
- 3) Sample volume
- 4) Viscometer model
- 5) Spindle used
- 6) Whether or not to attach the guard leg
- 7) Test speed or speeds (or the shear rate)
- 8) Length of time or number of spindle revolutions to record viscosity.
- 9) How sample was prepared and/or loaded into container.

## Appendix D - Spindle and Model Codes

Each spindle has a two digit entry code which is entered via the keypad on the DV-II+Pro. The entry code allows the DV-II+Pro to calculate Viscosity, Shear Rate and Shear Stress values.

Each spindle has two constants which are used in these calculations. The Spindle Multiplier Constant (SMC) used for viscosity and shear stress calculations, and the Shear Rate Constant (SRC), used for shear rate and shear stress calculations. Note that where  $SRC = 0$ , no shear rate/shear stress calculations are done and the data displayed is zero (0) for these functions.

*Table D-1 (Continued)*

SPINDLE	ENTRY CODE	SMC	SRC
RV1	01	1	0
RV2	02	4	0
RV3	03	10	0
RV4	04	20	0
RV5	05	40	0
RV6	06	100	0
RV7	07	400	0
HA1	01	1	0
HA2	02	4	0
HA3	03	10	0
HA4	04	20	0
HA5	05	40	0
HA6	06	100	0
HA7	07	400	0
HB1	01	1	0
HB2	02	4	0
HB3	03	10	0
HB4	04	20	0
HB5	05	40	0
HB6	06	100	0
HB7	07	400	0
LV1	61	6.4	0
LV2	62	32	0
LV3	63	128	0
LV4 or 4B2	64	640	0
LV5	65	1280	0
LV-2C	66	32	0.212
LV-3C	67	128	0.210
Spiral	70	105	0.677
T-A	91	20	0
T-B	92	40	0
T-C	93	100	0

SPINDLE	ENTRY CODE	SMC	SRC
T-D	94	200	0
T-E	95	500	0
T-F	96	1000	0
ULA	00	0.64	1.223
DIN-81	81	3.7	1.29
DIN-82	82	3.75	1.29
DIN-83	83	12.09	1.29
DIN-85	85	1.22	1.29
DIN-86	86	3.65	1.29
DIN-87	87	12.13	1.29
SC4-14	14	125	0.4
SC4-15	15	50	0.48
SC4-16	16	128	0.29
SC4-18	18	3.2	1.32
SC4-21	21	5	0.93
SC4-25	25	512	0.22
SC4-27	27	25	0.34
SC4-28	28	50	0.28
SC4-29	29	100	0.25
SC4-31	31	32	0.34
SC4-34	34	64	0.28
CPE-40 or CPA-40Z	40	0.327	7.5
CPE-41 or CPA-41Z	41	1.228	2
CPE-42 or CPA-42Z	42	0.64	3.8
CPE-51 or CPA-51Z	51	5.178	3.84
CPE-52 or CPA-52Z	52	9.922	2
V-71	71	2.62	0
V-72	72	11.1	0
V-73	73	53.5	0
V-74	74	543	0
V-75	75	213	0

*Table D-1*

Table D-2 lists the model codes and spring torque constants for each Viscometer model.

Table D-2

MODEL	TK	MODEL CODE ON DV-II+ SCREEN
LVDV-II+	0.09373	LV
2.5LVDV-II+	0.2343	2.5 LV
5LVDV-II+	0.4686	5 LV
1/4 RVDV-II+	0.25	0.25 RV
1/2 RVDV-II+	0.5	0.5 RV
RVDV-II+	1	RV
HADV-II+	2	HA
2HADV-II+	4	2 HA
2.5HADV-II+	5	2.5 HA
HBDV-II+	8	HB
2HBDV-II+	16	2 HB
2.5HBDV-II+	20	2.5 HB

The full scale viscosity range for any DV-II+Pro model and spindle may be calculated using the equation:

$$\text{Full Scale Viscosity Range [cP]} = \text{TK} * \text{SMC} * \frac{10,000}{\text{RPM}}$$

where:

TK = DV-II+Pro Torque Constant from Table D-2

SMC = Spindle Multiplier Constant from Table D-1

The Shear Rate calculation is:

$$\begin{aligned} (\text{Shear Stress (D/cm}^2)) &= \text{Viscosity (P)} * \text{Shear Rate (1/sec)} \\ &= \text{TK} * \text{SMC} * \text{SRC} * \text{TORQ} \end{aligned}$$

## Appendix E - Calibration Procedures

The accuracy of the DV-II+Pro is verified using viscosity standard fluids which are available from Brookfield Engineering Laboratories or your local Brookfield agent. Viscosity standards are Newtonian, and therefore, have the same viscosity regardless of spindle speed (or shear rate). Viscosity standards, calibrated at 25°C, are shown in **Table E-1** (Silicone Oils) and **Table E-2** (Mineral Oils).

For more help you can go to the website,  
[www.brookfieldengineering.com](http://www.brookfieldengineering.com), and download the video.

**Container size:** For Viscosity Standards < 30,000 cP, use a 600 ml Low Form Griffin Beaker having a working volume of 500 ml.

For Viscosity Standards ≥ 30,000 cP, use the fluid container.

Inside Diameter: 3.25”(8.25cm)

Height: 4.75”(12.1cm)

Note: Container may be larger, but may not be smaller.

**Temperature:** As stated on the fluid standard label: (+/-) 0.1°C

**Conditions:** The DV-II+Pro should be set according to the operating instructions. The water bath must be stabilized at test temperature. Viscometers with the letters “LV” or “RV” in the model designation must have the guard leg attached (see page 65 for more information on the guard leg).

Normal 25°C Standard Fluids		High Temperature Standard Fluids
Viscosity (cP)	Viscosity (cP)	Three Viscosity/Temperatures**
5	5,000	HT-30,000
10	12,500	HT-60,000
50	30,000	HT-100,000
100	60,000	
500	100,000	**25°C, 93.3°C, 149°C
1,000		Refer to Brookfield catalog for more information

Table E-1

MINERAL OIL VISCOSITY STANDARD FLUIDS	
BEL Part No.	Viscosity (cP) 25°C
B29	29
B200	200
B600	600
B1060	1,060
B2000	2,000
B10200	10,200
B21000	21,000
B73000	73,000
B200000	200,000
B360000	360,000

Table E-2

## Brookfield Viscosity Standard Fluid General Information

We recommend that Brookfield Viscosity Standard Fluids be replaced on an annual basis, one year from date of initial use. These fluids are pure silicone and are not subject to change over time. However, exposure to outside contaminants through normal use requires replacement on an annual basis. Contamination may occur by the introduction of solvent, standard of different viscosity or other foreign material.

Viscosity Standard Fluids may be stored under normal laboratory conditions. Disposal should be in accordance with state, local and federal regulations as specified on the material safety data sheet.

Brookfield Engineering Laboratories does not recertify Viscosity Standard Fluids. We will issue duplicate copies of the Certificate of Calibration for any fluid within two years of the purchase date. Brookfield Viscosity Standard Fluids are reusable provided they are not contaminated. Normal practice for usage in a 600 ml beaker is to return the material from the beaker back into the bottle. When using smaller volumes in accessories such as Small Sample Adapter, UL Adapter or Thermosel, the fluid is normally discarded.

## Calibration Procedure for LV #1-3 (#61-63) and RV, HA, HB #1-6 Brookfield Spindles

**Please note that the LV #4 (64) and RV, HA, HB #7 (07) spindles have been omitted from this procedure. Brookfield does not recommend the use of these spindles to perform a calibration check on your instrument. Reasons pertain to the small amount of spindle surface that makes contact with the viscosity standard, the difficulty of establishing the immersion mark precisely and the need for precise temperature control at 25°C in the immediate vicinity of the spindle.**

Follow these steps using one of the recommended spindles to verify calibration on your instrument:

- 1) Place the viscosity standard fluid (in the proper container) into the water bath.
- 2) Lower the DV-II+Pro into measurement position (with guard leg if LV or RV series Viscometer is used).
- 3) Attach the spindle to the Viscometer. If you are using a disk-shaped spindle, avoid trapping air bubbles beneath the disk by first immersing the spindle at an angle, and then connecting it to the Viscometer.
- 4) The viscosity standard fluid, together with the spindle, should be immersed in the bath for a minimum of 1 hour, stirring the fluid periodically, prior to taking measurements.
- 5) After 1 hour, check the temperature of the viscosity standard fluid with an accurate thermometer.
- 6) If the fluid is at test temperature ( $\pm 0.1^\circ\text{C}$  of the specified temperature, normally  $25^\circ\text{C}$ ), measure the viscosity and record the Viscometer reading. **Note: The spindle must rotate at least five (5) times before readings are taken.**
- 7) The viscosity reading should equal the **cP** value on the fluid standard to within the combined accuracies of the Viscometer and the viscosity standard (as discussed in the section entitled, Interpretation of Calibration Test Results) which appears later in this section.



## Calibration Procedure for a Small Sample Adapter

Brookfield recommends a two step check. First verify the calibration of the viscometer using the standard viscometer spindles (LV #1-3, RV #2-6, HA #2-6 and HB #2-6 or cone/plate spindles) as detailed in this appendix. Second verify the calibration of the viscometer using the Small Sample Adapter. The use of an accessory device may increase the accuracy of measurement associated with the DV-II+Pro.

When a Small Sample Adapter is used, the water jacket is connected to the water bath and the water is stabilized at the proper temperature:

- 1) Put the proper amount of viscosity standard fluid into the sample chamber. The amount varies with each spindle/chamber combination. (Refer to the Small Sample Adapter instruction manual).
- 2) Place the sample chamber into the water jacket.
- 3) Put the spindle into the test fluid and attach the extension link, coupling nut and free hanging spindle (or directly attach the solid shaft spindle) to the DV-II+Pro.
- 4) Allow 30 minutes for the viscosity standard, sample chamber and spindle to reach test temperature.
- 5) Measure the viscosity and record the Viscometer reading. **Note: The spindle must rotate at least five (5) times before readings are taken.**

## Calibration Procedure for a Thermosel System

Brookfield recommends a two step check. First verify the calibration of the viscometer using the standard viscometer spindles (LV #1-3, RV #2-6, HA #2-6 and HB #2-6 or cone/plate spindles) as detailed in this appendix. Second verify the calibration of the viscometer using the Thermosel. The use of an accessory device may increase the accuracy of measurement associated with the DV-II+Pro.

When a Thermosel System is used, the controller stabilizes the Thermo Container at the test temperature.

- 1) Put the proper amount of HT viscosity standard fluid into the HT-2 sample chamber. The amount varies with the spindle used. (Refer to the Thermosel instruction manual).
- 2) Place the sample chamber into the Thermo Container.
- 3) Put the spindle into the test fluid and attach the extension link, coupling nut and free hanging spindle (or directly attach the solid shaft spindle) to the DV-II+Pro.
- 4) Allow 30 minutes for the viscosity standard, sample chamber and spindle to reach test temperature.
- 5) Measure the viscosity and record the Viscometer reading. **Note: The spindle must rotate at least five (5) times before readings are taken.**

## Calibration Procedure using UL or DIN Adapters

Brookfield recommends a two step check. First verify the calibration of the viscometer using the standard viscometer spindles (LV #1-3, RV #2-6, HA #2-6 and HB #2-6 or cone/plate spindles) as detailed in this appendix. Second verify the calibration of the viscometer using the UL or DIN Adapters. The use of an accessory device may increase the accuracy of measurement associated with the DV-II+Pro.

When a UL or DIN UL Adapter is used, the water bath is stabilized at the proper temperature:

- 1) Put the proper amount of viscosity standard fluid into the UL Tube. (Refer to the UL Adapter instruction manual).
- 2) Attach the spindle (with extension link and coupling nut) onto the DV-II+Pro.
- 3) Attach the tube to the mounting channel.
- 4) Lower the tube into the water bath reservoir, or if using the ULA-40Y water jacket, connect the inlet/outlets to the bath external circulating pump.
- 5) Allow 30 minutes for the viscosity standard, sample chamber and spindle to reach test temperature.
- 6) Measure the viscosity and record the Viscometer reading. **Note: The spindle must rotate at least five (5) times before readings are taken.**

### Calibration Procedure using a Helipath Stand and T-Bar Spindles

When a Helipath Stand and T-Bar spindles are used:

- 1) Remove the T-bar spindle and select a standard LV (#1-3) or RV, HA, HB (#1-6) spindle. Follow the procedures for LV (#1-3) and RV, HA, HB (#1-6) Brookfield spindles outlined above.
- 2) **T-Bar spindles should not be used for verifying calibration of the DV-II+Pro Viscometer.**

### Calibration Procedure for Spiral Adapter

Brookfield recommends a two step check. First verify the calibration of the viscometer using the standard viscometer spindles (LV #1-3, RV #2-6, HA #2-6 and HB #2-6 or cone/plate spindles) as detailed in this appendix. Second verify the calibration of the viscometer using the Spiral Adapter. The use of an accessory device may increase the accuracy of measurement associated with the DV-II+Pro.

- 1) Place the viscosity standard fluid (in the proper container) into the water bath.
- 2) Attach the spindle to the viscometer. Attach chamber (SA-1Y) and clamp to the viscometer.
- 3) Lower the DV-II+Pro into measurement position. Operate the viscometer at 50 or 60 RPM until the chamber is fully flooded.
- 4) The viscosity standard fluid, together with the spindle, should be immersed in the bath for a minimum of 1 hour, stirring the fluid periodically (operate at 50 or 60 RPM periodically), prior to taking measurements.
- 5) After 1 hour, check the temperature of the viscosity standard fluid with an accurate thermometer.
- 6) If the fluid is at test temperature (+/- 0.1°C of the specified temperature, normally 25°C), measure the viscosity and record the viscometer reading. **Note: The spindle must rotate at least five (5) times for one minute, whichever is greater before readings are taken.**
- 7) The viscosity reading should equal the cP value on the viscosity fluid standard to within the combined accuracies of the viscometer and the standard (as discussed in the section entitled, Interpretation of Calibration Test Results). However, instrument accuracy is ±2% of the maximum viscosity range and not the standard 1%.

## Calibration Procedure for Cone/Plate Viscometers

- 1) Follow the above procedures for mechanically adjusting the setting of the cone spindle to the plate.
- 2) Refer to Appendix A, Table A-1, and determine the correct sample volume required for the selected spindle.
- 3) Select a viscosity standard fluid that will give viscosity readings between 10% and 100% of full scale range. Refer to Appendix B for viscosity ranges of cone spindles. Consult with Brookfield or an authorized dealer to determine which fluid is appropriate.

It is best to use a viscosity standard fluid that will be close to the maximum viscosity for a given cone spindle/speed combination.

### Example:

LVDV-II+Pro Viscometer, Cone CP-42, Fluid 10  
Having a viscosity of 9.7 cP at 25°C

At 60 RPM, the full scale viscosity range is 10.0 cP. Thus, the Viscometer reading should be 97% torque and 9.7 cP viscosity  $\pm 0.197$  cP (0.1 cP for the viscometer plus 0.097 cP for the fluid). The accuracy is a combination of Viscometer and fluid tolerance (refer to Interpretation of Calibration Test Results).

- 4) With the viscometer stopped, remove the sample cup and place the viscosity standard fluid into the cup, waiting 10 minutes for temperature equilibrium.
- 5) Connect the sample cup to the Viscometer. Allow sufficient time for temperature to reach equilibrium. Typically 15 minutes is the maximum time that you must wait. Less time is required if spindle and cup are already at test temperature.
- 6) Measure the viscosity and record the Viscometer reading in both % torque and centipoise (cP).

**Notes:** 1) **The spindle must rotate at least five (5) times before a viscosity reading is taken.**

- 2) The use of Brookfield Viscosity Standard fluids in the range of 5 cP to 5000 cP is recommended for cone/plate instruments. Please contact Brookfield Engineering Laboratories or an authorized dealer if your calibration procedure requires more viscous standards.
- 3) Select a viscosity standard fluid that will give viscosity readings between 10% and 100% of full scale range. Refer to Appendix B for viscosity ranges of cone spindles. Do not use a silicone viscosity standard fluid with a viscosity value greater than 5000 cP with a Cone/Plate Viscometer. Brookfield offers a complete range of mineral oil viscosity standards suitable for use with Cone/Plate Viscometers as shown in Table E-2. Consult with Brookfield or an authorized dealer to determine which fluid is appropriate.

## Interpretation of Calibration Test Results:

When verifying the calibration of the DV-II+Pro, the instrument and viscosity standard fluid error must be combined to calculate the total allowable error.

The DV-II+Pro is accurate to (+/-) 1% of the range in use when using spindles LV #1-3, RV #2-6, HA #2-6 and HB #2-6. When using an accessory device with the DV-II+Pro such as Small

Sample Adapter, UL Adapter, Thermosel, Spiral Adapter, and DIN Adapter the accuracy value may be increased. In general the increase in accuracy will be minimal, however, it could be as much as 1% for a total accuracy of +/- 2% of the range in use.

Brookfield Viscosity Standards Fluids are accurate to (+/-) 1% of their stated value.

**Example:** Calculate the acceptable range of viscosity using RVDV-II+Pro with RV-3 Spindle at 2 RPM; Brookfield Standard Fluid 12,500 with a viscosity of 12,257 cP at 25°C:

- 1) Calculate full scale viscosity range using the equation:

$$\text{Full Scale Viscosity Range [cP]} = \text{TK} * \text{SMC} * \frac{10,000}{\text{RPM}}$$

Where:

TK - 1.0 from **Table D-2**

SMC = 10 from **Table D-1**

$$\text{Full Scale Viscosity Range} = \frac{1 * 10 * 10,000}{2} = 50,000 \text{ cP}$$

The viscosity is accurate to (+/-) 500 cP (which is 1% of 50,000)

- 2) The viscosity standard fluid is 12,257 cP. Its accuracy is (+/-)1% of 12,257 or (+/-)122.57 cP.
- 3) Total allowable error is (122.57 + 500) cP = (+/-) 622.57 cP.
- 4) Therefore, any viscosity reading between 11,634.4 and 12,879.6 cP indicates that the Viscometer is operating correctly. Any reading outside these limits may indicate a Viscometer problem. Contact the Brookfield technical sales department or your local Brookfield dealer/distributor with test results to determine the nature of the problem.

**Example:** Calculate the acceptable accuracy for viscosity measurement using LVDV-II+ Pro with SC4-21 spindle in Small Sample Adapter at 6, 12, and 30 RPM. Brookfield viscosity standard fluid 100 cPs has an actual value of 101.5 cP at 25°C.

- 1) Calculate the full scale viscosity range either by using the Spindle Range Coefficient in Appendix B of More Solutions to Sticky Problems or by using the Auto Range button on your viscometer.

The Spindle Range Coefficient for the 21 spindle on an LV Torque instrument is 4,688.

At 6 RPM, the Full Scale Range (FSR) viscosity is 781 cP. Allow +/- 1% for the viscometer and +/- 1% for the Small Sample Adapter. Total allowable accuracy is:

$$\pm 2\% \times 781 \text{ cP} = \pm 15.6 \text{ cP}$$

A similar calculation at 12 RPM gives FSR = 391 cP:  $\pm 2\% \times 391 \text{ cP} = \pm 7.8 \text{ cP}$

A similar calculation at 30 RPM gives FSR = 156 cP:  $\pm 2\% \times 156 \text{ cP} = \pm 3.1 \text{ cP}$

2) The Viscosity Standard Fluid is 101.5 cP. Its accuracy is:

$$\pm 1\% \times 101.5 \text{ cP} = \pm 1.015 \text{ cP} \text{ or roughly } \pm 1.0 \text{ cP} \text{ for further calculations.}$$

3) Total accuracy is the sum of the values n (1) and (2):

$$\text{At 6 RPM, accuracy is: } 15.6 \text{ cP} + 1.0 \text{ cP} = \pm 16.6 \text{ cP}$$

$$\text{At 12 RPM, accuracy is: } 7.8 \text{ cP} + 1.0 \text{ cP} = \pm 9.8 \text{ cP}$$

$$\text{At 30 RPM, accuracy is: } 3.1 \text{ cP} + 1.0 \text{ cP} = \pm 4.1 \text{ cP}$$

4) Therefore, at each speed, the acceptable windows within which the measured viscosity value must lie is calculated relative to the viscosity value of the standard:

$$\text{At 6 RPM: } 84.9 \text{ cP to } 118.1 \text{ cP}$$

$$\text{At 12 RPM: } 91.7 \text{ cP to } 111.3 \text{ cP}$$

$$\text{At 30 RPM: } 97.4 \text{ cP to } 105.6 \text{ cP}$$

If your measured values fall outside of these windows, contact Brookfield or your authorized dealer to discuss your results and determine whether your instrument is out of calibration.

## Appendix F - The Brookfield Guardleg

The guard leg was originally designed to protect the spindle during use. The first applications of the Brookfield Viscometer included hand held operation while measuring fluids in a 55-gallon drum. It is clear that under those conditions the potential for damage to the spindle was great. Original construction included a sleeve that protected the spindle from side impact. Early RV guard legs attached to the dial housing and LV guard legs attached to the bottom of the pivot cup with a twist and lock mechanism.

The current guard leg is a band of metal in the shape of the letter U with a bracket at the top that attaches to the pivot cup of a Brookfield Viscometer/Rheometer. Because it must attach to the pivot cup, the guard leg cannot be used with a Cone/Plate instrument. A guard leg is supplied with all LV and RV series instruments, but not with the HA or HB series. Its shape (shown in Figure F-1) is designed to accommodate the spindles of the appropriate spindle set; therefore, the RV guard leg is wider than the LV due to the large diameter of the RV #2 spindle. They are not interchangeable.

The calibration of the Brookfield Viscometer/Rheometer is determined using a 600 mL Low Form Griffin Beaker. The calibration of LV and RV series instruments includes the guard leg. The beaker wall (for HA/HB instruments) or the guard leg (for LV/RV instruments) define what is called the “outer boundary” of the measurement. The spindle factors for the LV, RV, and HA/HB spindles were developed with the above boundary conditions. The spindle factors are used to convert the instrument torque (expressed as the dial reading or %Torque value) into centipoise. Theoretically, if measurements are made with different boundary conditions, e.g., without the guard leg or in a container other than 600 ml beaker, then the spindle factors found on the Factor Finder cannot be used to accurately calculate an absolute viscosity. Changing the boundary conditions does not change the viscosity of the fluid, but it does change how the instrument torque is converted to centipoise. Without changing the spindle factor to suit the new boundary conditions, the calculation from instrument torque to viscosity will be incorrect.

Practically speaking, the guard leg has the greatest effect when used with the #1 & #2 spindles of the LV and RV spindle sets (Note: RV/HA/HB #1 spindle is not included in standard spindle set). Any other LV (#3 & #4) or RV (#3 - #7) spindle can be used in a 600 mL beaker with or without the guard leg to produce correct results. The HA and HB series Viscometers/Rheometers are not supplied with guard legs in order to reduce the potential problems when measuring high viscosity materials. HA/HB spindles #3 through #7 are identical to those spindle numbers in the RV spindle set. The HA/HB #1 & #2 have slightly different dimensions than the corresponding RV spindles. This dimensional difference allows the factors between the RV and HA/HB #1&#2 spindles to follow the same ratios as the instrument torque even though the boundary conditions are different.

The recommended procedures of using a 600 mL beaker and the guard leg are difficult for some customers to follow. The guard leg is one more item to clean. In some applications the 500 ml of test fluid required to immerse the spindles in a 600 mL beaker is not available. In practice, a smaller vessel may be used and the guard leg is removed. The Brookfield Viscometer/Rheometer will produce an accurate and repeatable torque reading under any measurement circumstance. However, the conversion of this torque reading to centipoise will only be correct if the factor used was developed for those specific conditions. Brookfield has outlined a method for recalibrating a Brookfield Viscometer/Rheometer to any measurement circumstance in More Solutions to Sticky Problems. It is important to note that for many viscometer users the true viscosity is not as important as a repeatable day to day value. This repeatable value can be obtained without any special effort for any measurement circumstance. But, it

should be known that this type of torque reading will not convert into a correct centipoise value when using a Brookfield factor if the boundary conditions are not those specified by Brookfield.

The guard leg is a part of the calibration check of the Brookfield LV and RV series Viscometer/Rheometer. Our customers should be aware of its existence, its purpose and the effect that it may have on data. With this knowledge, the viscometer user may make modifications to the recommended method of operation to suit their needs.

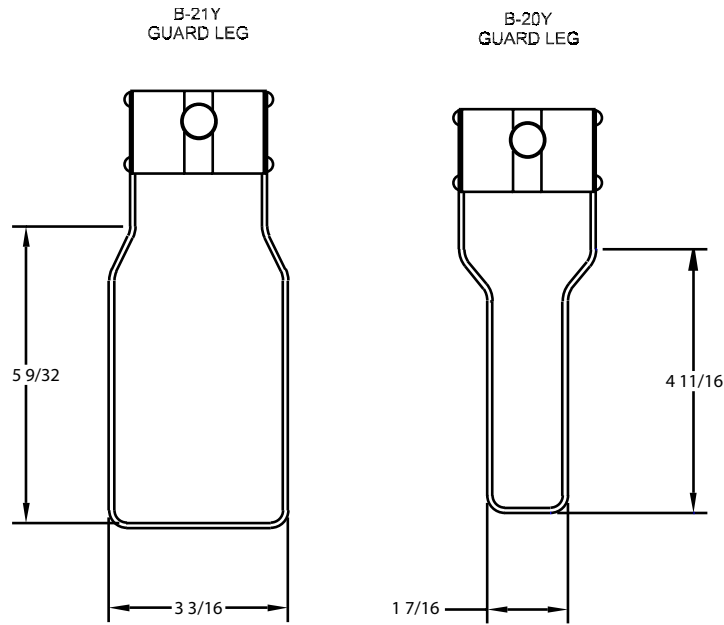

Figure F-1 - Brookfield Guard Leg

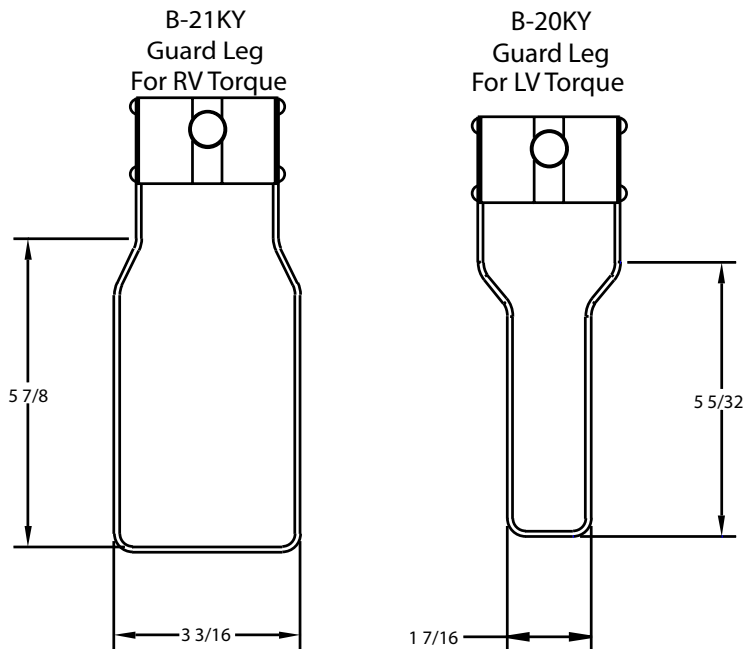

Figure F-2 - Brookfield EZ-Lock Guard Leg

## Appendix G - Speed Sets

The following speed sets and custom speeds are selectable from the SETUP menu option. All speeds are in units of RPM.

Interleave	
Speed	From
0.0	
0.3	LVT
0.5	RVT
0.6	LVT
1.0	RVT
1.5	LVT
2.0	RVF
2.5	RVT
3.0	LVT
4.0	RVF
5.0	RVT
6.0	LVT
10.0	RVT
12.0	LVT
20.0	RVT
30.0	LVT
50.0	RVT
60.0	LVT
100.0	RVT

OR

Sequential	
Speed	From
0.0	
0.3	LVT
0.6	LVT
1.5	LVT
3.0	LVT
6.0	LVT
12.0	LVT
30.0	LVT
60.0	LVT
0.0	
0.5	RVT
1.0	RVT
2.0	RVF
2.5	RVT
4.0	RVF
5.0	RVT
10.0	RVT
20.0	RVT
50.0	RVT
100.0	RVT

OR

Custom		
Speed	Speed	Speed
0.0	→ 3.0	→ 100.0
0.01	4.0	105.0
0.03	5.0	120.0
0.05	6.0	135.0
0.07	7.5	140.0
0.09	8.0	150.0
0.1	10.0	160.0
0.2	12.0	180.0
0.3	15.0	200.0
0.4	17.0	
0.5	20.0	
0.6	22.0	
0.7	25.0	
0.8	30.0	
0.9	35.0	
1.0	40.0	
1.1	45.0	
1.2	50.0	
1.4	60.0	
1.5	70.0	
1.8	75.0	
2.0	80.0	
2.5	90.0	

The DV-II+Pro has the sequential speed set installed at Brookfield prior to shipment.

The DV-II+Pro can be programmed to select up to 18 of the above speeds for use at any one time. Speed 0.0 is automatically included as the 19th speed.

*Note:* Additional speeds are available when using Rheocalc Software (DV-II+Pro in external mode - see **section II.9**).



## Appendix H - Communications

When using the Brookfield Computer Cable (Brookfield part # DVP-80), the DV-II+Pro will output a data string at a rate of approximately 3 times per second. When using the Brookfield Printer Cable (Brookfield Part No. DVP-81), the output rate is 1.0 times per second. The DV-II+Pro uses the following RS-232 parameters to output these strings:

Baud Rate	9600
Data Bits	8
Stop Bits	1
Parity	None
Handshake	None

The following formulas should be used to calculate and display the Viscometer data after each packet of data is obtained from the DV-II+Pro.

$$\text{Viscosity (cP)} = \frac{100}{\text{RPM}} * \text{TK} * \text{SMC} * \text{Torque}$$

$$\text{Shear Rate (} \frac{1}{\text{Sec}} \text{)} = \text{RPM} * \text{SRC}$$

$$\text{Shear Stress (} \frac{\text{Dynes}}{\text{Cm}^2} \text{)} = \text{TK} * \text{SMC} * \text{SRC} * \text{Torque}$$

Where:

RPM = Current Viscometer spindle speed in RPM

TK = Viscometer torque constant from Appendix D, Table D-2.

SMC = Current spindle multiplier constant from Appendix D, Table D-1.

SRC = Current spindle shear rate constant from Appendix D, Table D-1.

Torque = Current Viscometer torque (%) expressed as a number between 0 and 100.

As an example, consider an LV Viscometer using an SC4-31 spindle, running at 30 RPM and currently displaying a Torque of 62.3 (%). First we list all of the given data and include model and spindle constants from Appendix D, Tables D-1 and D-2:

RPM = **30** from the example statement.

TK = **0.09373** from Appendix D for an LV Viscometer.

SMC = **32.0** from Appendix D for a type SC4-31 spindle.

SRC = **0.34** from Appendix D for a type SC4-31 spindle.

Torque = **62.3** from the example statement.

Applying this data to the above equations yields:

$$\text{Viscosity (cP)} = \frac{100}{\text{RPM}} * \text{TK} * \text{SMC} * \text{Torque}$$

$$= \frac{100}{30} * 0.09373 * 32.0 * 62.3$$

$$= 622.9 \text{ cP}$$

$$\text{Shear Rate (} \frac{1}{\text{Sec}} \text{)} = \text{RPM} * \text{SRC}$$

$$= 30 * 0.34$$

$$= 10.2 \frac{1}{\text{Sec}}$$

$$\text{Shear Stress (} \frac{\text{Dynes}}{\text{Cm}^2} \text{)} = \text{TK} * \text{SMC} * \text{SRC} * \text{Torque}$$

$$= 0.09373 * 32.0 * 0.34 * 62.3$$

$$= 63.5 \frac{\text{Dynes}}{\text{Cm}^2}$$

## DV-II+ Serial and Analog Outputs

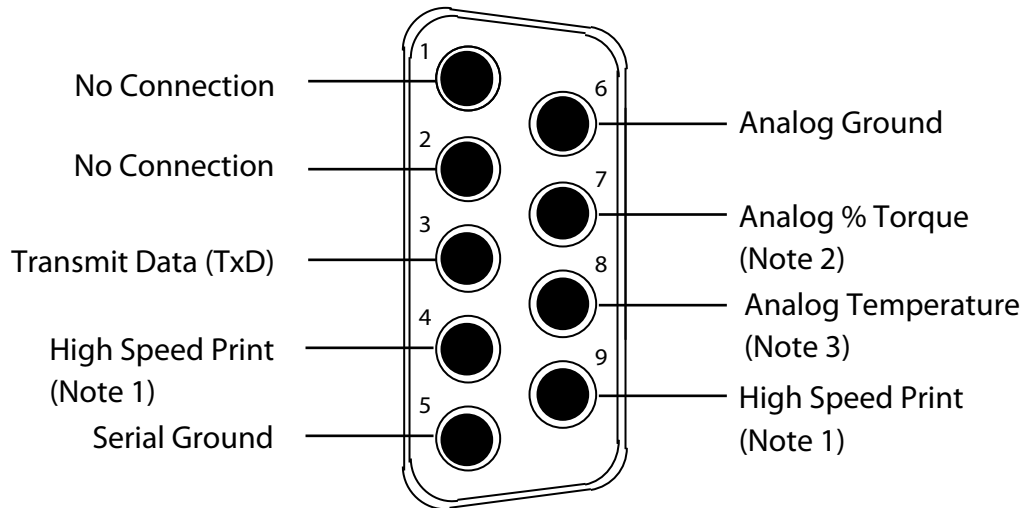

Figure H-1

### Notes:

1. Placing a jumper across pins 4 and 9 causes the DV- II+ to output computer data at a 3 line-per-second rate. No jumper across pins 4 and 9 retains the once-per-second printer output rate.
2. This is a 0-1 volt d.c. output where 0 volts corresponds to 0% torque and 1 volt corresponds to 100 % torque with a resolution of 1 millivolt (0.1%).
3. This is a 0-3.75 volt d.c. output where 0 volts corresponds to -100°C and 3.75 volts corresponds to +275°C with a resolution of 1 millivolt (0.1°C).

### Analog Output:

The analog outputs for temperature and % torque are accessed from the 9-pin connector located on the rear panel of the DV-II+Pro. The pin connections are shown in Figure H-1.

The output cable (Part No. DVP-96Y) connections are:

<b>Red Wire:</b>	Temperature Output
<b>Black Wire:</b>	Temperature Ground
<b>White Wire:</b>	% Torque Output
<b>Green Wire:</b>	% Torque Ground

*Note:* Please contact Brookfield Engineering Laboratories or your local dealer/distributor for purchase of the DVP-96Y analog output cable.

## Appendix I - Model S Laboratory Stands

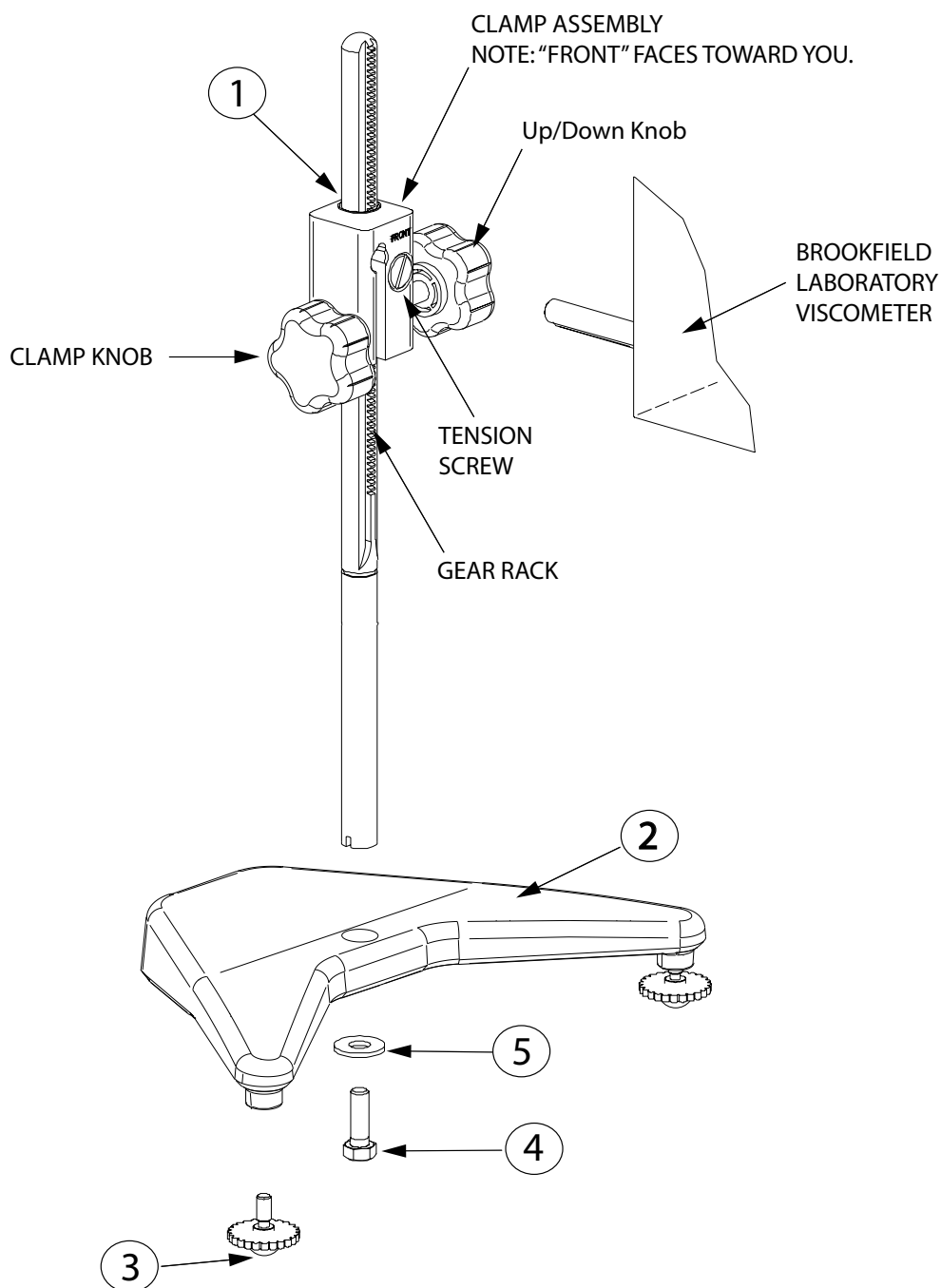

ITEM	PART #	DESCRIPTION	QTY.
1	VS-CRA-14S VS-CRA-18S	14" UPRIGHT ROD AND CLAMP ASSEMBLY 18" UPRIGHT ROD AND CLAMP ASSEMBLY	1 Optional
2	VS-2Y	BASE, includes 2 VS-3 leveling screws	1
3	VS-3	LEVELING SCREW available separately or in assembly above	2
4	50S311832S01B	SCREW 5/16 X 1" Hex Head	1
5	502028071S33B	FLAT WASHER 5/16 X 7/8 X .071	1

Figure I-1

## Unpacking

Check carefully to see that all the components are received with no concealed damage.

- 1 Base, VS-2, with 2 Leveling Screws, VS-3, packed in a cardboard carton
- 1 Upright Rod with attached Clamp Assembly in the instrument case

## Assembly (Refer to Figure I-1)

1. Remove the base assembly from the carton.
2. Remove the screw and washer from the upright rod. Place the rod and clamp assembly into the hole in the top of the base.

**Note:** The “Front” designation on the clamp assembly should face toward you.

3. Rotate the rod/clamp assembly slightly until the slot on the bottom of the rod intersects the pin located in the base.
4. While holding the rod and base together, insert the slotted screw and washer as shown and tighten securely.

## Viscometer Mounting

Insert the Viscometer mounting rod into the hole (with the cut-away slot) in the clamp assembly. Adjust the instrument level until the bubble is centered from right to left and tighten the clamp knob (clockwise). Use the leveling screws to “fine” adjust the viscometer level.

**Note:** If the Digital Viscometer cannot be leveled, check to insure that the rod is installed with the gear rack facing forward.



**Caution:** Do not tighten the clamp knob unless the viscometer mounting rod is inserted in the clamp assembly.

## Operation

Rotate the UP/DOWN knob to raise or lower the viscometer. Adjust the tension screw if the UP/DOWN movement of the viscometer head is not acceptable, i.e. too easy or too difficult.

## Appendix J - DVE-50A Probe Clip

Probe Clip DVE-50A is supplied with all model DV-II+Pro Viscometers, DV-III Rheometers, and Digital Temperature Indicators. It is used to attach the RTD temperature probe to the LV Guard Leg (Part No. B-20Y) or 600 ml low form Griffin beaker. Figure J-1 is a view of the Probe Clip, showing the hole into which the RTD probe is inserted, and the slot which fits onto the LV guard leg. When inserting the RTD probe into the Probe Clip, the upper part of the Clip is compressed by squeezing the points shown in Figure J-1.

*Note:* All Viscometer/Rheometer models — except LV — use the Probe Clip as shown in Figure J-3.

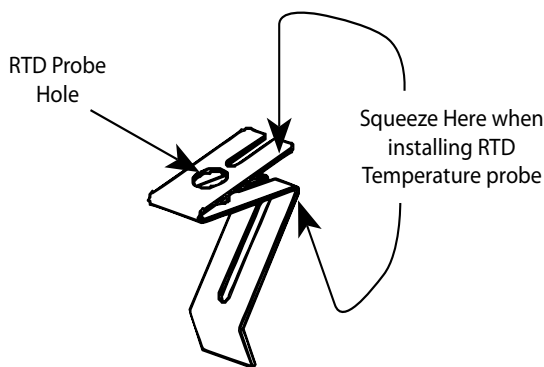

Figure J-1

Figure J-2 shows the Probe Clip (with RTD temperature probe installed) mounted on the LV guard leg.

Figure J-3 shows the Probe Clip mounted in a 600 ml low form Griffin beaker. This mounting may be used with LV, RV, HA and HB series instruments.



**Caution:** Temperature probe must not contact the spindle during measurement.

*Note:* The RTD probe must be parallel to the beaker wall so as not to interfere with the viscosity measurement.

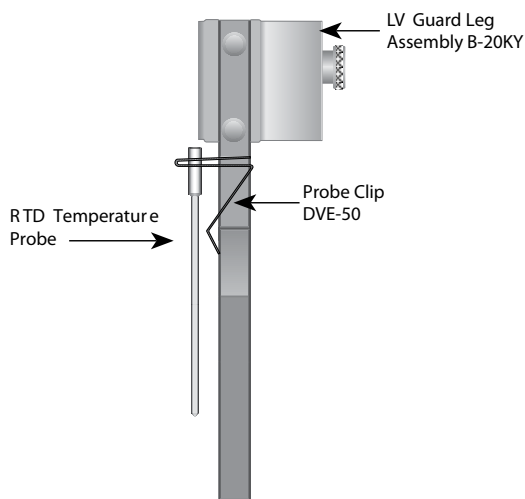

Figure J-2

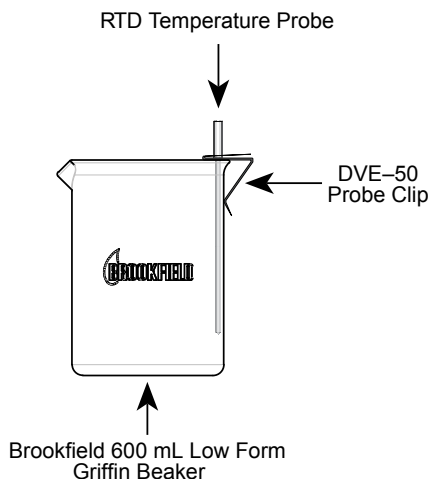

Figure J-3

## Appendix K -Fault Diagnosis and Troubleshooting

Listed are some of the more common problems that you may encounter while using your Viscometer.

### ❑ Spindle Does Not Rotate

- ✓ Make sure the viscometer is plugged in.
- ✓ Check the voltage rating on your viscometer (115, 220V); it must match the wall voltage.
- ✓ Make sure the motor is ON and the desired rpm is selected.

### ❑ Zero RPM is the Only Available Speed

- ✓ Check speed set selection (section IV.2.3). If custom speed is selected, make sure that additional speeds, other than zero, have an Asterisk (\*).

### ❑ Spindle Wobbles When Rotating or Looks Bent

- ✓ Make sure the spindle is tightened securely to the viscometer coupling.
- ✓ Check the straightness of all other spindles; replace if bent.
- ✓ Inspect viscometer coupling and spindle coupling mating areas and threads for dirt; clean threads on spindle coupling with a 3/56 left-hand tap.
- ✓ Inspect threads for wear; if the threads are worn, the unit needs service (see Appendix M). Check to see if spindles rotate eccentrically or wobble. There is an allowable runout of 1/32-inch in each direction (1/16-inch total) when measured from the bottom of the spindle rotating in air.
- ✓ Check to see if the viscometer coupling appears bent; if so, the unit is in need of service (see Appendix N, “Warranty Repair and Service”).

### ❑ Inaccurate Readings

- ✓ Verify spindle, speed and model selection.
- ✓ Verify spindle selection is correct on DV-II+Pro.
- ✓ If % readings are under-range (less than 10%), the display will flash; change spindle and/or speed.
- ✓ “EEEE” on the digital display means the unit is over-range (greater than 100%); reduce speed and/or change spindle.
- ✓ Verify test parameters: temperature, container, volume, method. Refer to:
  - “More Solutions to Sticky Problems”, Section III
  - “DV-II+Pro Viscometer Operating Instructions, Appendix C, “Variables in Viscosity Measurements.
- ✓ Perform a calibration check; follow the instructions in Appendix E.
- ✓ Verify tolerances are calculated correctly.
- ✓ Verify the calibration check procedures were followed exactly.

If the unit is found to be out of tolerance, the unit may be in need of service. See Appendix N for details on “Warranty Repair and Service”.

### ❑ Viscometer Will Not Return to Zero

- ✓ Viscometer is not level
    - Check with spindle out of the sample
    - Adjust the laboratory stand
  - ✓ Pivot point or jewel bearing faulty
    - Perform an Oscillation Check\*
      - ✓ Remove the spindle and turn the motor OFF; select display to % torque mode.
      - ✓ Gently push up on the viscometer coupling.
      - ✓ Turn the coupling until the digital display reads 10-15 on the % display.
      - ✓ Gently let go of the coupling.
      - ✓ Watch the digital display; you should see a “run” of numbers next to the %; the “run” of numbers should ultimately stop at 0.0 (+/- 0.1).
- If the digital display does not return to ZERO, the unit most likely is in need of service.
- Perform calibration check (See Appendix E)
  - Contact Brookfield Engineering Laboratories, Inc. or your Brookfield dealer for repair (See Appendix N).

\* This procedure does not apply to instruments with ball bearing suspension. (See section I.3)

### ❑ Display Reading Will Not Stabilize

- ✓ Special characteristic of sample fluid. There is no problem with the viscometer.
  - Refer to Appendix C
- ✓ Check for erratic spindle rotation.
  - Verify power supply
  - Contact Brookfield Engineering Laboratories, Inc. or your Brookfield dealer for repair.
- ✓ Bent spindle or spindle coupling.
  - Contact Brookfield Engineering Laboratories, Inc. or your Brookfield dealer for repair.
- ✓ Temperature fluctuation in sample fluid.
  - Use temperature bath for control

### ❑ No Recorder Response

- ✓ Be Sure the viscometer is not at ZERO reading.
- ✓ Be sure the recorder is ON and not on STANDBY.
- ✓ Verify the range settings.
- ✓ Check cable leads for clean connection.
- ✓ Verify cable connections (see Appendix H).

## ❑ Recorder Pen Moves in Wrong Direction

- ✓ Output polarity reversed
  - Reverse leads

## ❑ Viscometer Wil Not Communicate with PC

- ✓ Check the comm port and make sure the correct port is being utilized.
- ✓ Check the interconnecting cable for proper installation
- ✓ Check the Options menu and make sure the PC PROG is set to either “ON” or “OFF” in accordance with the operating instructions for the program/procedure in use.

If the above do not rectify the problem, do the following:

- ✓ Shut off viscometer
- ✓ Attach printer.
- ✓ Press and hold the MOTOR ON/OFF and ENTER/AUTORANGE keys simultaneously while turning the viscometer power on. Figure K-1 appears on the viscometer display.



*Figure K-1*

- ✓ Press ENTER/AUTORANGE key and Figure J-2 appears.

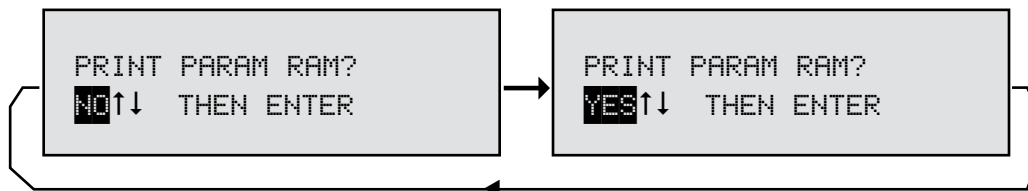

*Figure K-2*

- ✓ Scroll to YES and press the ENTER/AUTORANGE key. Figure K-3 appears.

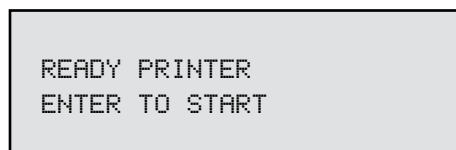

*Figure K-3*

- ✓ Press ENTER/AUTORANGE. Information similar to Figure K-4 will appear on your printer output.



Timed Stop	Minutes		01
	Seconds		30
	RPM		50
Time to Torque	Torque %		60
	RPM		50
Print Interval	Minutes		00
	Seconds		05
Printer Port	Parallel or Serial		Parallel
Last Spindle used			05
Special Spindle	AA	SMC	0000.000
Special Spindle	AA	SRC	00.000
Special Spindle	BB	SMC	0000.000
Special Spindle	BB	SRC	00.000
Special Spindle	CC	SMC	0000.000
Special Spindle	CC	SRC	00.000
Special Spindle	DD	SMC	0000.000
Special Spindle	DD	SRC	00.000
Display Units			CGS
Temperature Scale			C
Speed Set			INTERLEAVE
Viscometer Model			RV
Last BEVIS Program			1
Raw Temps			2E0C 00FE
Torque Scale			E19F

*Figure K-4*

- ✓ Call Brookfield to review the information on your printer output.
- ✓ Figure K-5 next appears on the viscometer display. Turn the viscometer power off.

SETUP COMPLETE  
TURN POWER OFF

*Figure K-5*

# Appendix L - Instrument Dimensions

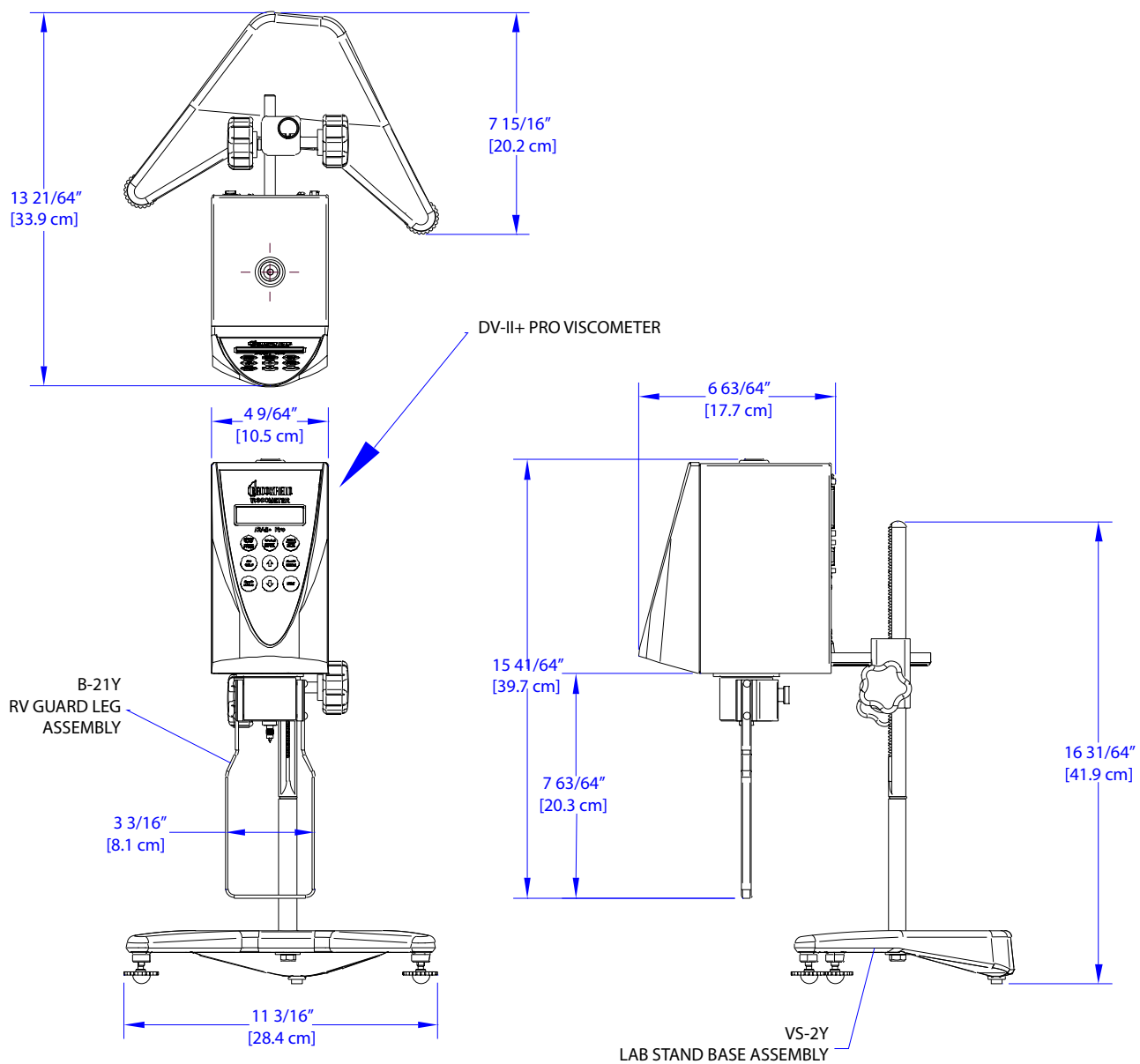

### **www.brookfieldengineering.com\*\***

The Brookfield website is a good resource for additional and self-help whenever you need it. Our website offers a selection of “how-to” videos, application notes, conversion tables, instructional manuals, material safety data sheets, calibration templates and other technical resources.

### **<http://www.youtube.com/user/BrookfieldEng>**

Brookfield has its own YouTube channel. Videos posted to our website can be found here as well as other “home-made” videos made by our own technical sales group.

### **Viscosityjournal.com**

Brookfield is involved with a satellite website that should be your first stop in viscosity research. This site serves as a library of interviews with experts in the viscosity field as well as Brookfield technical articles and conversion charts. Registration is required, so that you can be notified of upcoming interviews and events, however, this information will not be shared with other vendors, institutions, etc..

### **Article Reprints**

- **Available in Print Only**
- Brookfield has an extensive library of published articles relating to viscosity, texture and powder testing. Due to copyright restrictions, these articles cannot be emailed. Please request your hardcopy of articles by calling our customer service department directly or by emailing: [marketing@brookfieldengineering.com](mailto:marketing@brookfieldengineering.com)
- **Available Online**
- Brookfield has a growing number of published articles that can be downloaded directly from the Brookfield website. These articles can be found on our main site by following this path: [http://www.brookfieldengineering.com/support/documentation/article reprints](http://www.brookfieldengineering.com/support/documentation/article%20reprints)

### **More Solutions to Sticky Problems**

Learn more about viscosity and rheology with our most popular publication. This informative booklet will provide you with measurement techniques, advice and much more. It's a must-have for any Brookfield Viscometer or Rheometer operator. More Solutions is available in print and also as a downloadable pdf on the Brookfield website by following this path:

<http://www.brookfieldengineering.com/support/documentation>

### **Training/Courses**

Whether it is instrument-specific courses, training to help you better prepare for auditing concerns, or just a better understanding of your methods, who better to learn from than the worldwide leaders of viscosity measuring equipment? Visit our Services section on our website to learn more about training.

\*\* Downloads will require you to register your name, company and email address. We respect your privacy and will not share this information outside of Brookfield.

## Appendix N - Warranty Repair and Service

### Warranty

Brookfield Viscometers are guaranteed for one year from date of purchase against defects in materials and workmanship. They are certified against primary viscosity standards traceable to the National Institute of Standards and Technology (NIST). The Viscometer must be returned to **Brookfield Engineering Laboratories, Inc.** or the Brookfield dealer from whom it was purchased for no charge warranty service. Transportation is at the purchaser's expense. The Viscometer should be shipped in its carrying case together with all spindles originally provided with the instrument. If returning to Brookfield please contact us for a return authorization number prior to shipping.

For a copy of the Repair Return Form, go to the Brookfield website,  
[www.brookfieldengineering.com](http://www.brookfieldengineering.com)

For repair or service in the **United States** return to:

Brookfield Engineering Laboratories, Inc.  
11 Commerce Boulevard  
Middleboro, MA 02346 U.S.A.  
Telephone: (508) 946-6200 FAX: (508) 946-6262  
[www.brookfieldengineering.com](http://www.brookfieldengineering.com)

For repair or service outside the United States consult Brookfield Engineering Laboratories, Inc. or the dealer from whom you purchased the instrument.

For repair or service in the **United Kingdom** return to:

Brookfield Viscometers Limited  
Brookfield Technical Centre  
Stadium Way  
Harlow, Essex CM19 5GX, England  
Telephone: (44) 1279/451774 FAX: (44) 1279/451775  
[www.brookfield.co.uk](http://www.brookfield.co.uk)

For repair or service in **Germany** return to:

Brookfield Engineering Laboratories Vertriebs GmbH  
Hauptstrasse 18  
D-73547 Lorch, Germany  
Telephone: (49) 7172/927100 FAX: (49) 7172/927105  
[www.brookfield-gmbh.de](http://www.brookfield-gmbh.de)

For repair or service in **China** return to:

Guangzhou Brookfield Viscometers and Texture Instruments Service Company Ltd.  
Suite 905, South Tower, Xindacheng Plaza  
193 Guangzhou Da Dao Bei, Yuexiu District  
Guangzhou, 510075 P. R. China  
Telephone: (86) 20/3760-0548 FAX: (86) 20/3760-0548  
[www.brookfield.com.cn](http://www.brookfield.com.cn)

*On-site service at your facility is also available from Brookfield. Please contact our Service Department in the United States, United Kingdom, Germany or China for details.*

This tear-off sheet is a typical example of recorded test data. Please photocopy and retain this template so that additional copies may be made as needed.

<b>VISCOSITY TEST REPORT</b>		DATE:	FOR:
		BY:	
TEST INFORMATION:			
CONCLUSIONS:			