

United States Department of Commerce
Technology Administration
National Institute of Standards and Technology

NIST Special Publication 821

*Wavenumber Calibration Tables From
Heterodyne Frequency Measurements*

Arthur G. Maki and Joseph S. Wells



A11103 693551

NATIONAL INSTITUTE OF STANDARDS &
TECHNOLOGY
Research Information Center
Gaithersburg, MD 20899



NIST Special Publication 821

Wavenumber Calibration Tables From Heterodyne Frequency Measurements

Arthur G. Maki¹
Molecular Physics Division
Physics Laboratory
National Institute of Standards and Technology
Gaithersburg, MD 20899

and

Joseph S. Wells²
Time and Frequency Division
Physics Laboratory
National Institute of Standards and Technology
Boulder, CO 80303

Current Addresses:

¹ 15012 24th Ave. S.E.
Mill Creek, WA 98012

² Phlatirons Photonics, Inc.
2385 Kohler Dr.
Boulder, CO 80303

Sponsored in part by
NASA Upper Atmospheric Research Program
Washington, DC 20548

December 1991



U.S. Department of Commerce
Robert A. Mosbacher, Secretary
Technology Administration
Robert M. White, Under Secretary for Technology
National Institute of Standards and Technology
John W. Lyons, Director

National Institute of Standards
and Technology
Special Publication 821
Natl. Inst. Stand. Technol.
Spec. Publ. 821
645 pages (Dec. 1991)
CODEN: NSPUE2

U.S. Government Printing Office
Washington: 1991

For sale by the Superintendent
of Documents
U.S. Government Printing Office
Washington, DC 20402

CONTENTS

	page
Preface	v
Chapter I	
Introduction	1
References	3
Chapter II	
Techniques Used for Infrared Heterodyne Frequency Measurements	5
Preliminary Considerations	5
CO ₂ Laser Standard Frequencies	6
Heterodyne Frequency Measurements with the TDL and CO ₂ Laser (860 to 1120 cm ⁻¹)	8
TDL Locking Procedure and Minimization of Error	14
Measurement of the Difference Frequency between the TDL and Gas (CO ₂ or CO) Laser	15
Minimization of the Difference Frequency Uncertainties	16
Measurements with a CO Laser Transfer Oscillator and CO ₂ Laser Synthesizer	17
Measurements with the Color Center Laser	20
References	22
Chapter III	
Formulas and Data Sources Used to Prepare the Tables	23
Expressions Used for Fitting the Frequency Data and for Calculating the Transition Wavenumbers	23
Data Sources Used for Fitting the Frequency Data and for Calculating the Transition Wavenumbers	25
OCS	25
N ₂ O	28
CS ₂	30
CO	31
NO	32
Intensity Calculations	32
Calculation of the strength factors	34
Herman-Wallis terms	37
Data Sources for Intensity Calculations	37
OCS	37
N ₂ O	39
CS ₂	41
CO	41
fundamental band	41
first overtone	42
NO	42
Other Line Parameters	42
Lineshape and pressure broadening	42
lifetime broadening	43
Doppler broadening	43
pressure broadening	44

	Voigt profile	44
	collisional narrowing	45
	Estimating peak intensities	45
	Pressure-induced lineshifts	46
	References	47
Chapter IV		
	Error Analysis	49
	Accuracy of the Calibration Source	49
	Uncertainty in Locating the Line center	49
	Accuracy of Transferring the Calibration to the Line Center Measurement	50
	Errors Caused by Environmental Effects	51
	Uncertainties in the Application of Least-squares Techniques	51
	Summary	52
Chapter V		
	Bibliography	53
	Intensity and Pressure Broadening Bibliographies	53
	Microwave Tables and Bibliographies	53
	OCS	53
	N ₂ O	60
	CO	65
	NO	69
	CS ₂	71
Chapter VI		
	Atlas and Wavenumber Tables	73
	Description	73
	Diskettes with Detailed Linelist	74
	CO Atlas - 1948 to 2275 cm ⁻¹ and 4071 to 4352 cm ⁻¹	75
	Energy Level Diagram for OCS	132
	OCS Atlas - 486 to 567 cm ⁻¹	133
	OCS Atlas - 812 to 890 cm ⁻¹	159
	OCS Atlas - 1000 to 1095 cm ⁻¹	185
	OCS Atlas - 1650 to 1739 cm ⁻¹	213
	OCS Atlas - 1832 to 1934 cm ⁻¹	241
	OCS Atlas - 1970 to 2141 cm ⁻¹	271
	OCS Atlas - 2510 to 2600 cm ⁻¹	315
	OCS Atlas - 2693 to 2763 cm ⁻¹	335
	OCS Atlas - 2862 to 2970 cm ⁻¹	349
	OCS Atlas - 3065 to 3120 cm ⁻¹	379
	Energy Level Diagram for N ₂ O	390
	N ₂ O Atlas - 523 to 659 cm ⁻¹	391
	N ₂ O Atlas - 880 to 1087 cm ⁻¹	423
	N ₂ O Atlas - 1105 to 1345 cm ⁻¹	446
	N ₂ O Atlas - 1820 to 1925 cm ⁻¹	503
	N ₂ O Atlas - 2140 to 2269 cm ⁻¹	525
	N ₂ O Atlas - 2400 to 2607 cm ⁻¹	558
	N ₂ O Atlas - 2725 to 2842 cm ⁻¹	595
	CS ₂ Atlas - 1460 to 1551 cm ⁻¹	621
	NO Atlas - 1741 to 1940 cm ⁻¹	639
APPENDIX	Useful equations and formulas	654

PREFACE

We dedicate this volume to the memory of the late F. Russell Petersen, who was one of three original members of the project and who made invaluable contributions until his untimely demise in 1983. Russ was known for his CO₂ laser expertise, but his contributions and knowledge of physics extended over a much wider range. His dedication to manuscripts was meticulous, his wry humor was uplifting, and his presence tended to put things in the proper perspective. On occasion when debating whether a measurement was of sufficient accuracy, he would remark, "All we can do is the best we can." We have attempted to carry the work forward with this attitude. He left a legacy not only of his CO₂ lasers which are still in use, but also a sense of inspiration to those of us in the Time and Frequency Division of the National Institute of Standards and Technology (NIST).

We are grateful to our colleague of many years, D. A. Jennings, for his contributions which included writing the frequency synthesis programs, collaboration on some TDL measurements and some experiments with nonlinear crystals, as well as various discussions in general. M. D. Vanek has also been an especially valuable coworker in the past few years. We gratefully acknowledge the contributions of various visiting physicists who worked on the tunable diode laser (TDL) heterodyne measurements. The first was D. J. Suple of Front Range Community College in Westminster, Colo. More recently guest researchers, A. Hinz and M. Schneider, from Prof. W. Urban's group in the Institut für Angewandte Physik of the Univ. of Bonn, have made especially valuable contributions in experiments with the liquid-nitrogen-cooled CO laser. L. Zink was also an important contributor following completion of his Ph.D. at the Univ. of Colorado. It was a pleasure working with every one of these Time and Frequency Division visiting scientists.

Of special value were the contributions by our friend, C. R. Pollock, during his tenure as a post doctoral fellow at NIST. These included not only his color center expertise in improving CO₂ frequencies, but also measurements at 2.3 μm on CO, and N₂O.

The results of other types of measurements were used in conjunction with the heterodyne measurements. We thank W. B. Olson, formerly of the NIST Molecular Physics Division, especially for his Fourier transform spectroscopy (FTS) measurements. Other major contributors to the accumulation of data upon which we also drew include A. Fayt, G. Guelachvili, J. W. C. Johns, and J. Kauppinen.

We are also very appreciative of the long term support of the measurement program and the encouragement to aggregate the results in book form by the chiefs of our organizational units, D. B. Sullivan of the Time and Frequency Division and A. Weber of the Molecular Physics Division. We thank J. Burkholder of NOAA and D. A. Jennings and M. Young of NIST for helpful comments regarding the manuscript. We gratefully acknowledge the partial support of this program over the past decade by the Upper Atmospheric Research Office of the National Aeronautics and Space Agency.

ABSTRACT

This new calibration atlas is based on frequency rather than wavelength calibration techniques for absolute references. Since a limited number of absolute frequency measurements is possible, additional data from alternate methodology are used for difference frequency measurements within each band investigated by frequency measurement techniques. Data from these complementary techniques include the best Fourier transform measurements available. Included in the text portion of the atlas are a description of the heterodyne frequency measurement techniques, details of the analysis including the Hamiltonians and least-squares-fitting and calculation procedures. Also included are other relevant considerations such as intensities and lineshape parameters. A 350-entry bibliography which contains all data sources used and a subsequent section on errors conclude the text portion.

The larger portion of the atlas consists of several hundred spectral-maps/facing-tables pages for the various calibration molecules. The spectral maps (as well as the facing tables) are calculated from the molecular constants derived for the work. The primary calibration molecules are the linear triatomics, carbonyl sulfide and nitrous oxide, which cover portions of the infrared spectrum ranging from 488 to 3120 cm^{-1} . Some gaps in the coverage afforded by OCS and N_2O are partially covered by NO, CO, and CS_2 . An additional region from 4000 to 4400 cm^{-1} based on CO is also included.

Key words: calibration atlas; carbonyl sulfide; carbon monoxide; carbon disulfide; IR frequency calibrations; IR wavenumber calibrations; nitric oxide; nitrous oxide; wavenumber tables.

Chapter I

INTRODUCTION

The primary purpose of this book is to provide an atlas of molecular spectra and associated tables of wavenumbers to be used for the calibration of infrared spectrometers. A secondary purpose is to furnish a detailed description of the infrared heterodyne frequency measurement techniques developed for this work. Additionally, we provide a bibliography of all the measurements used in producing these tables, as well as to provide a description of how those measurements were combined to calculate energy levels, transitions and uncertainties. We also provide useful related information such as line intensities, pressure broadening coefficients, and estimates of pressure shifts of spectral lines. This book does not include an exhaustive list of all the weaker transition frequencies currently available, especially for the less abundant molecular species. Such a list, containing over 10 000 transitions for OCS, is available, however, in floppy disk form from the authors. To put this book in proper perspective, some background, philosophy, and the status of existing atlases are discussed in the following sections.

Over the last 35 years (since the work of Downie *et al.* [1.1]) several compilations of infrared absorption spectra intended for the calibration of infrared spectrometers have appeared. Two compilations have been published by the International Union of Pure and Applied Chemistry (IUPAC) [1.2,1.3] and contain sections pertaining to the calibration of fairly low resolution (0.5 cm^{-1}) instruments. Other compilations [1.4-1.7] and other sections of the IUPAC compilations [1.2,1.3] were devoted to data intended for the calibration of high resolution instruments (resolution better than 0.5 cm^{-1}). This book falls into the latter category. Of the earlier compilations, only the work of Guelachvili and Rao [1.7] provides calibration data that are consistently more accurate than $\pm 0.01\text{ cm}^{-1}$.

A number of commercially available infrared spectrometers are capable of recording spectra with a resolution of 0.06 cm^{-1} or better. For the calibration of such spectrometers, one needs calibration data with an uncertainty smaller than 1/30th of the spectral linewidth. For a resolution of 0.06 cm^{-1} this means an accuracy of 0.002 cm^{-1} . For Doppler-limited resolution at room temperatures, a calibration accuracy of 0.0002 cm^{-1} or better would be desirable. The present work responds to these needs, even though it was recognized that state-of-the-art instrumentation (for sub-Doppler measurements, for example) could use even more accurate calibration data.

Most high resolution spectrometers are not capable of broad frequency scans. For the most accurate measurements the calibration should be applied to each spectral scan. This requires that at least one and preferably several calibration points be available within the scanning range of the spectrometer. For tunable diode laser spectrometers, a single scan may cover only 0.5 cm^{-1} , while for a Fourier transform spectrometer (FTS) a high resolution scan may cover hundreds of wavenumbers. This means that for many purposes calibration standards should be no more than 100 cm^{-1} apart, while for other purposes standards no more than 0.5 cm^{-1} apart are required throughout the infrared region of interest. Our work here presents a compromise between these two requirements.

In our opinion, all previous compilations of infrared wavenumber standards have suffered from the lack of a consistent effort to draw together a number of experimental measurements to arrive at a well determined set of molecular energy levels which could be used to determine frequency (or wavenumber) standards for a number of bands throughout the infrared spectral region. The present compilation provides a model for producing such frequency or wavenumber calibration data.

It is appropriate at this point to define some of the terminology used in this book clarifying an important distinction: in some places emphasis is placed on the difference between frequency measurements and wavelength measurements. All measurements that can be reduced to counting frequencies or frequency differences are frequency measurements, while all measurements that are

really comparisons of wavelengths (or wavenumbers), including counting fringes, are wavelength measurements. Fourier transform measurements, for instance are truly wavelength measurements even though counting (of fringes of a laser beam passed through the spectrometer for, example) may be involved.

Most measurements of infrared absorption spectra are made using grating or Fourier transform spectrometers. These measurements are truly wavelength measurements. They rely for calibration on measuring the difference in wavelength of some calibration feature and the feature of the spectrum to be determined. For FTS instruments, the position of the moveable mirror must be determined, while for grating instruments one is essentially calibrating the grating angle and the spacing of the grooves of the grating. Very often these instruments use more than one beam and compare the wavelength of a calibration beam with the beam carrying the spectra of interest. With FTS instruments a helium-neon laser beam is often used to monitor the mirror position. In other cases a single beam is used, but one cannot be certain that the beam properties are independent of wavelength. With all wavelength measuring instruments, it is extremely important that the calibration light beam follow precisely the same path through the spectrometer as the beam of light being measured. Problems of wavelength-dependent diffraction effects become very important for measurements intended to approach or exceed one part in 10^7 . One of the most insidious problems with wavelength measurements is the risk (or ease) of incurring systematic errors and the virtual impossibility of detecting them.

The great advantage of frequency measurements is that they simply depend on frequency counting techniques. Over the years considerable attention has been given to electronic techniques of frequency counting, and simple, accurate, well calibrated devices are readily available. The accuracy of frequency techniques does not depend on whether or not the beams are perfectly collinear or have parallel wavefronts. If a countable signal (25 dB signal-to-noise ratio) is obtained, it will be correct. The frequency of light does not depend on the medium, nor does it depend on the angle from which it is viewed.

Over the past decade we have striven to provide infrared heterodyne frequency measurements on the transitions and energy levels of several simple molecules, which are good candidates for frequency calibration standards. OCS, CO, and N_2O were chosen because they are stable, safe to handle, easily obtainable, and well documented in terms of good measurements reported in existing literature. Furthermore, they are particularly amenable to the accurate calculation of energy levels from a relatively simple Hamiltonian.

For these molecules a least-squares fit of many transitions (over 3000 OCS lines for example) has permitted the determination of all of the lower energy separations, using frequency differences referred to the primary cesium frequency standard. Due to statistical improvements from a large data base, transition frequencies between these energy levels can be calculated with greater accuracy than any single measurement with its attendant random errors.

Although we have had to use some FTS (wavelength) measurements to help define certain higher order rotational constants, for the most part the energy levels were determined from *frequency* measurements because they are less susceptible to unknown systematic errors than are wavelength measurements. Particular importance was attached to estimating the uncertainties in the transition wavenumbers; see the discussion in the chapter on errors (Chapter IV).

As with any good calibration standard, a number of different measurements were used in determining the energy levels and transition frequencies. However, only a few laboratories have used frequency measurement techniques in the infrared region and very few of the more accurate sub-Doppler frequency measurements have been made, so it is somewhat premature to claim the level of accuracy that we desire for infrared standards. Nevertheless we are encouraged by the convergence of different FTS measurements on the same values for the band centers as frequency measurements. Our publication of this atlas at this time is dictated by the need to provide good calibration data now, rather than await the arrival of a perfect atlas.

Of course the combination of OCS, CO, and N₂O gases is insufficient to provide calibration data everywhere within the infrared, so we have had to provide heterodyne measurements on other molecular species, such as CS₂ and NO in order to fill some of the gaps. The user will still note that many gaps remain in the coverage appearing by these tables. To some extent these gaps may be filled by using the data provided by the compilation of Guelachvili and Rao [1.6]. We also expect that future measurements will provide calibration data where none are currently available.

Since most workers are more comfortable with calibration data given in wavenumber units, the tables in this book are given in wavenumbers (cm⁻¹) even though the values were primarily determined from frequency measurements. The conversion from frequency units to wavenumber units was made by using the defined value of the velocity of light, $c = 299\,792\,458$ m/s. Since the tables are given in wavenumbers, we often use the terms wavenumber and frequency interchangeably in the text, but the term wavelength is reserved for quantities determined by wavelength measurements and must not be confused with frequency measurements.

References

- [1.1] A. R. Downie, M. C. Magoon, T. Purcell, and B. Crawford, Jr., "The calibration of infrared prism spectrometers," *J. Opt. Soc. Am.* **43**, 941-951 (1953).
- [1.2] "*Tables of Wavenumbers for the Calibration of Infrared Spectrometers*," prepared by the Commission on Molecular Structure and Spectroscopy of IUPAC, Butterworths, Washington (1961).
- [1.3] A. R. H Cole, "*Tables of Wavenumbers for the Calibration of Infrared Spectrometers*," 2nd edition, prepared by the Commission on Molecular Structure and Spectroscopy of IUPAC, Pergamon Press, New York (1977).
- [1.4] E. K. Plyler, A. Danti, L. R. Blaine, and E. D. Tidwell, "Vibration-rotation structure in absorption bands for the calibration of spectrometers from 2 to 16 microns," *J. Res. NBS* **64A**, 29-48 (1960).
- [1.5] K. Narahari Rao, R. V. deVore, and Earle K. Plyler, "Wavelength Calculations in the Far infrared (30 to 1000 microns)," *J. Res. NBS* **67A**, 351-358 (1963).
- [1.6] K. Narahari Rao, C. J. Humphreys, and D. H. Rank, "*Wavelength Standards in the Infrared*," Academic Press, New York (1966).
- [1.7] G. Guelachvili, and K. Narahari Rao, "*Handbook of Infrared Standards*," Academic Press, Inc., San Diego (1986).

Chapter II

TECHNIQUES USED FOR INFRARED HETERODYNE FREQUENCY MEASUREMENTS

Preliminary Considerations

At the present time the only frequency measurements that have been made on infrared absorption spectra of molecules treated in this book are those made in the NIST Boulder Laboratories [5.73]¹, the Harry Diamond Laboratories [5.88], the University of Lille [5.126], and University of Bonn [5.321]. The measurements of the N₂O laser transition frequencies made at the National Research Council of Canada [5.183] were also used here. This chapter describes the techniques that have been used in the NIST Boulder frequency measurements in order to familiarize the reader with the techniques that have evolved. We hope that such familiarity will give greater confidence in the accuracy of the results.

The first heterodyne frequency measurements on carbonyl sulfide (OCS) were made in the NIST Boulder Labs. A frequency-stabilized CO₂ laser served as the local oscillator for these heterodyne measurements. For this chapter, the term local oscillator is reserved for the fixed-frequency oscillator which carries the reference frequency information (near the frequency of the molecular transition to be measured) to the mixer or heterodyne detector. For each OCS measurement, the frequency of a tunable diode laser (TDL) was locked to the peak of a selected (OCS) absorption line with an assigned uncertainty, $\delta\nu_{\text{lock}}$, given by $\pm \frac{1}{2}\Delta\nu_{\text{Dopp}}/\text{SNR}$, where $\Delta\nu_{\text{Dopp}}$ is the full Doppler width at half maximum and SNR is the signal-to-noise ratio of the first derivative lock signal. The frequency of the locked TDL was compared with the frequency of the CO₂ laser frequency standard by mixing the TDL and CO₂ laser radiation in a fast (1 GHz, 3 dB bandwidth) HgCdTe detector. The resulting difference-frequency beatnote was measured with the aid of a spectrum analyzer and a marker oscillator (a conventional oscillator whose frequency was tuned to the center of the beatnote). The frequency of the OCS transition was the sum of the CO₂ laser frequency and the appropriately signed beatnote frequency.

Similar sets of measurements have also been made in which the TDL was heterodyned against a CO laser local oscillator (or transfer oscillator). In these cases the frequency of the CO laser was simultaneously measured relative to a frequency synthesized from combinations of CO₂ laser standard frequencies [5.94]. In a third type of measurement, a tunable color center laser (CCL) was the local oscillator. In this case, the CCL (which was locked to the transition of interest) was heterodyned directly with a frequency synthesized from CO₂ laser standards [5.304]. All three techniques are discussed in detail later in this chapter.

The determination of the spectroscopic constants for a particular band of a selected molecule was based on a number of measurements such as those described above. Some preliminary considerations for selection of the particular transitions to be measured were as follows. A review of the set of transitions of a particular band of interest served as a starting point. This set was reduced immediately to those transitions whose frequencies were within 10 GHz (the approximate combined bandpass limit of the HgCdTe detector-rf-amplifier that was used) of the frequency of a CO₂ laser or a CO laser transition frequency. Those transitions which were blended with nearby transitions from other bands or isotopic species of the molecule of interest were deleted from this subset. An attempt was then made to select (from the candidates available at this point) and measure those transitions which permitted the best determination of the constants. As a minimal set, these included low-*J* transitions in both the *P*- and *R*-branches in order to determine the band center, intermediate-*J*

¹ Rather than repeat references given in the bibliography (Chapter V), they are referenced as [5.XX]. The references at the end of Chapter II are referenced as [2.XX], *etc.*

transitions for determining the B -value, and high- J (60 to 100 depending on the particular band strength) transitions for the centrifugal distortion constants. If possible, additional measurements were made in order to cover the entire band with the smallest gaps possible. This served to increase the redundancy and to minimize extrapolated values in the calculated frequencies.

In some instances, it was not possible to realize the above goals. The region of interest often covered 100 cm^{-1} or so and typical TDL frequency coverage (guaranteed by the vendor) was 15 cm^{-1} , although many times the coverage turned out to be larger. Within the 15 cm^{-1} region, there were usually holes in coverage and it was necessary to buy the TDLs in pairs. An additional factor which was not within the experimenter's control concerned frequency holes (regions where the beatnote was not discernible) in the bandpass of the combination of the HgCdTe detector and the rf amplifiers which follow it. These two factors were the final restrictions on the set of measurements which were used to determine the spectroscopic constants for the band.

CO₂ Laser Standard Frequencies

The 1.25 m long CO₂ lasers used in these measurements were constructed by the late F. R. Petersen [2.1]. These had gratings for line selection and output mirrors typically coated for 85% transmission. In order to render the output beams nearly parallel, compensated output coupling mirrors were utilized. By compensated, we mean that the anti-reflection coated surface of the mirror was formed with a smaller radius of curvature than the reflecting concave surface. Irises at both ends were available for mode discrimination and control of the power output, which was 1 to 3 W. These lasers were equipped with internal absorption cells (filled to a pressure of 5.3 Pa (40 mTorr) of carbon dioxide) to provide frequency stabilization by the Freed-Javan technique [2.2]. Although some seven isotopic combinations of CO₂ have been the object of extensive frequency measurements, only three isotopes have been used for the NIST heterodyne frequency measurements. These were ¹²C¹⁶O₂ (626), ¹³C¹⁶O₂ (636) and ¹²C¹⁸O₂ (828). [The shorthand notation used here involves the last digits in the rounded nuclear masses for the three atoms, O, C, and O. For example, the ¹⁶O¹²C¹⁶O laser is designated (626).] In addition to the 1.25 m lasers, a 2 m laser with a similar grating and compensated output mirror (but with an external absorption cell for stabilization) was used for high- J and hot band transitions. This longer laser has been operated with the three different isotopic gases.

The frequencies of the CO₂ transitions were initially related to the cesium standard in an NBS experiment published in 1973 (Evenson *et al.* [2.1]). This was an experiment in which the frequency of the methane stabilized HeNe laser was measured. A new wavelength measurement (Barger and Hall [2.3]) of the same methane transition was concurrently completed. The combination of these two quantities led to a new (at that time) value for the speed of light, 299 792 456.2(1.1) m/s [2.4].

Figure 1a shows a block diagram of the frequency chain used in the methane frequency measurement. For the sake of brevity, the values of the offset frequencies in that experiment are not discussed here; the interested reader is referred to the original paper [2.1]. The essential details of the chain are as follows. An X-band klystron was phase-locked to a quartz crystal oscillator and the X-band frequency was accurately measured by a counter which was referred to the cesium standard. The seventh harmonic of the X-band frequency was used to phase-lock a 74 GHz klystron. The twelfth harmonic of the 74 GHz oscillator was used as a reference to frequency lock an HCN laser. The twelfth harmonic of the HCN laser frequency was close enough to the frequency of the 28 μm water vapor laser for the difference to be made up by the frequency from a phase-locked klystron. Three harmonics of the water vapor laser and another phase-locked klystron frequency moved the chain up to the CO₂ laser region, to the transition R₁₁(10). Another frequency from a phase-locked klystron moved the chain from the 9.3 μm band to the 10.6 μm band, to R₁(30) in particular. Three harmonics of the frequency of the R₁(30) transition brought the chain up near the frequency of the methane-stabilized HeNe laser. (The measured values for these transitions are indicated in the boxes in Fig. 1a and the values are given in terahertz.) Petersen *et al.* [2.5] subsequently used the measured

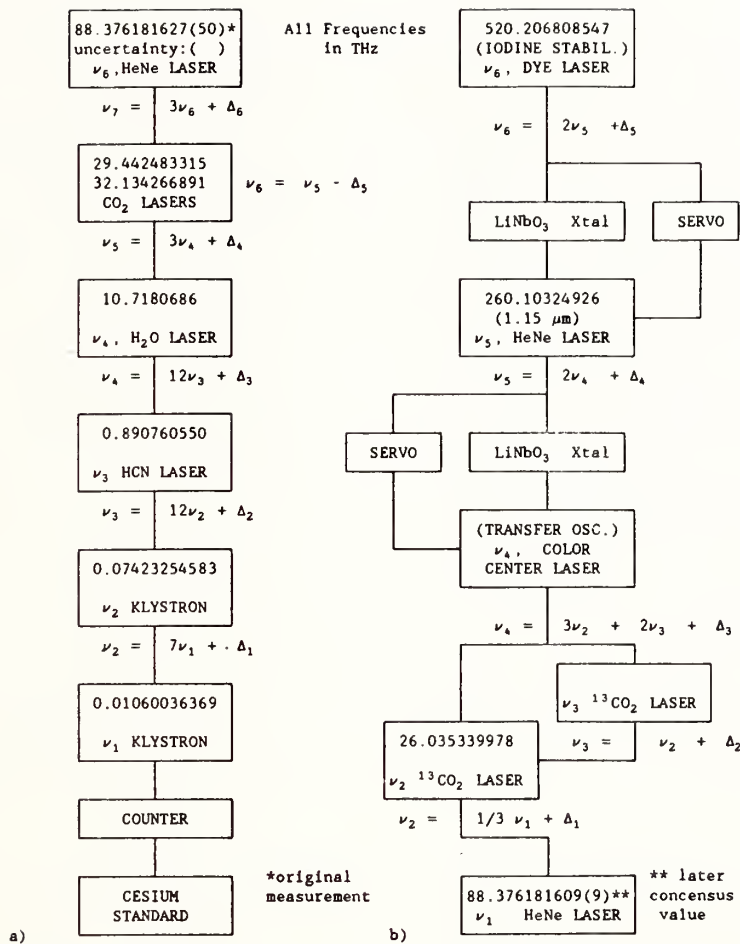

Fig. 1. Diagrams of Schemes Relating CO₂ Frequencies to the Cesium Standard.

values for these two transitions to make additional CO₂ laser frequency measurements and to generate tables of transitions for both the I and II branches.

Since 1973 several different international laboratories have repeated this frequency measurement experiment with minor variations and confirmative measurements have led to a new value for the speed of light which is now defined to be 299 792 458 m/s [2.6]. The proposal and expected acceptance of this new definition provided impetus to extend frequency measurements to the visible portion of the spectrum. Major efforts at NIST-Boulder accomplished this objective and experiments were published in 1983 by Pollock *et al.* [2.7], and by Jennings *et al.* [2.8].

Figure 1b shows a diagram of the chain used to measure the iodine transition at 520 THz (576 nm) [2.7]. The details of this chain are of secondary importance for purposes here, but a sketch will be provided. The starting point was the stabilized HeNe laser at 3.39 μ m. A best value for this transition was determined from the most accurate results of the international measurements. The P₁(50) transition of a stabilized ¹³CO₂ laser was measured relative to the stabilized HeNe laser, which was assumed to oscillate at the frequency 88 376 181.609 ± 0.009 MHz. The frequency resettability of the CO₂ laser was reported to be within 5 parts in 10¹¹, which is better than the 1 part in 10¹⁰ uncertainty in the frequency of the HeNe laser. (Petersen *et al.* [2.9] later used this accurately measured P₁(50) transition to measure other CO₂ transitions and to generate improved calibration tables.)

To continue with the sketch, we note that a second $^{13}\text{CO}_2$ transition $P_1(52)$ was phase-locked to $P_1(50)$ by means of a stabilized 62 GHz klystron. The synthesis scheme used to arrive at the CCL frequency is indicated in Fig. 1b. The remainder of the chain was locked from the top down. That is, the second harmonic of the $1.15\ \mu\text{m}$ HeNe laser frequency was locked to the frequency of the dye laser, which was in turn locked to the frequency of the "o" hyperfine component of the visible (576 nm) $^{127}\text{I}_2$ 17-1 P(62) transition. The CCL was in turn locked to the frequency of the $1.15\ \mu\text{m}$ HeNe laser. Both the HeNe and the CCL served as transfer oscillators in this scheme. The comparison was made at the CCL- CO_2 laser point of the chain. In a separate experiment, the HeNe laser was locked to its Lamb dip and that frequency was determined. The $^{13}\text{CO}_2$ frequency listed in Fig. 1b is the frequency used in the 520 THz determination (it was frequency-offset-locked from a stabilized CO_2 laser to remove the dither) and is not the frequency of the center of the transition. The values for the two higher frequencies are given in Fig. 1b. Additional details may be found in Ref. [2.7].

The frequencies currently used for the $^{12}\text{C}^{16}\text{O}_2$ isotope are based on the most recent values (which made use of the above results) which were published in 1983 by Petersen *et al.* [2.9]. The stated 1 sigma uncertainties for the calculated tables based on these measurements are smaller than 5 kHz for the CO_2 transitions ($J < 40$) which were used in the infrared heterodyne measurements. Subsequent CO_2 measurements relative to the values of Petersen were made by Freed and coworkers at MIT [2.10]. The uncertainties in the MIT values are also less than 5 kHz for the $^{13}\text{C}^{16}\text{O}_2$ transitions (and less than 10 kHz for the $^{12}\text{C}^{18}\text{O}_2$ transitions) used here. Note that the 1.25 m CO_2 lasers used in the TDL measurements were first generation lasers and that the numbers given in Tables 1, 2, and 3 were obtained using second generation lasers. Even if the reproducibility in the laser lock for the older lasers were somewhat poorer (an uncertainty of about 50 kHz was allowed for the realization of the frequencies) it would be of negligible consequence for the results presented here. The transition frequency values (for the three carbon dioxide isotopes) which were used are given in Tables 1, 2, and 3.

Listed in Table 4 are the frequencies and wavenumbers for some transitions of the $^{13}\text{CO}_2$ hot band (01¹1-[11⁰0,03¹0]₁) which extend the useful range of standard reference frequencies. These frequencies were determined from NIST measurements in which the 2 m CO_2 laser and an external reference cell were used. While measurements were made on both the 636 and 626 isotopes [2.11, 2.12], only the 636 frequencies were used for subsequent TDL measurements. The two sigma uncertainties for the transitions used for OCS measurements were less than 80 kHz.

For the measurements in the CO_2 laser region, the CO_2 frequencies given in some of our papers were rounded to the nearest 0.1 MHz. However, the full accuracy of the CO_2 frequencies was retained for calculating or synthesizing the CO frequencies and the CO frequency was then rounded to the nearest 0.1 MHz.

Heterodyne Frequency Measurements with the TDL and CO_2 Laser (860 to 1120 cm^{-1})

The measurement procedure has evolved over the course of this work [5.73, 5.83, 5.87, 5.221, 5.230, 5.243]. A brief history of the TDL refrigeration evolution and the details of the apparatus and procedure currently in use will be described here. For considerations involving the TDL, refer to Fig. 2, which is a block diagram of the measurement scheme recently used for some N_2O measurements [5.243].

The first commercially available TDL spectrometers featured liquid helium Dewars as the refrigeration system. Our initial system used a 4 l helium Dewar. It was necessary to use an assortment of stainless steel shims between the Dewar's OFHC (oxygen free high conductivity) copper cold surface and the TDL in order to vary the temperature (and operating wavenumber) of the TDL. The use of liquid helium was inconvenient, changing shims was cumbersome, and the resulting temperature cycling of the TDLs was reputed to shorten their lifetime; nevertheless a narrow TDL linewidth was generally observed.

Table 1. Frequencies (MHz) for the 626 carbon dioxide laser.

P(50)	27 413 600.4112	P(50)	30 480 527.0432
P(48)	27 478 430.1483	P(48)	30 545 874.3287
P(46)	27 542 482.6299	P(46)	30 610 516.1385
P(44)	27 605 762.5803	P(44)	30 674 445.7649
P(42)	27 668 274.4491	P(42)	30 737 656.7009
P(40)	27 730 022.4165	P(40)	30 800 142.6462
P(38)	27 791 010.3989	P(38)	30 861 897.5131
P(36)	27 851 242.0547	P(36)	30 922 915.4319
P(34)	27 910 720.7882	P(34)	30 983 190.7566
P(32)	27 969 449.7554	P(32)	31 042 718.0701
P(30)	28 027 431.8676	P(30)	31 101 492.1893
P(28)	28 084 669.7958	P(28)	31 159 508.1695
P(26)	28 141 165.9746	P(26)	31 216 761.3094
P(24)	28 196 922.6060	P(24)	31 273 247.1550
P(22)	28 251 941.6621	P(22)	31 328 961.5037
P(20)	28 306 224.8891	P(20)	31 383 900.4083
P(18)	28 359 773.8096	P(18)	31 438 060.1801
P(16)	28 412 589.7252	P(16)	31 491 437.3923
P(14)	28 464 673.7190	P(14)	31 544 028.8828
P(12)	28 516 026.6578	P(12)	31 595 831.7569
P(10)	28 566 649.1936	P(10)	31 646 843.3897
P(8)	28 616 541.7658	P(8)	31 697 061.4282
P(6)	28 665 704.6019	P(6)	31 746 483.7926
P(4)	28 714 137.7193	P(4)	31 795 108.6785
P(2)	28 761 840.9258	P(2)	31 842 934.5572
R(0)	28 832 026.2179	R(0)	31 913 172.5750
R(2)	28 877 902.4362	R(2)	31 958 996.0676
R(4)	28 923 046.4283	R(4)	32 004 017.3874
R(6)	28 967 457.0638	R(6)	32 048 236.2545
R(8)	29 011 133.0037	R(8)	32 091 652.6661
R(10)	29 054 072.6995	R(10)	32 134 266.8957
R(12)	29 096 274.3924	R(12)	32 176 079.4916
R(14)	29 137 736.1122	R(14)	32 217 091.2759
R(16)	29 178 455.6756	R(16)	32 257 303.3427
R(18)	29 218 430.6853	R(18)	32 296 717.0558
R(20)	29 257 658.5273	R(20)	32 335 334.0465
R(22)	29 296 136.3697	R(22)	32 373 156.2114
R(24)	29 333 861.1596	R(24)	32 410 185.7086
R(26)	29 370 829.6209	R(26)	32 446 424.9556
R(28)	29 407 038.2514	R(28)	32 481 876.6251
R(30)	29 442 483.3197	R(30)	32 516 543.6414
R(32)	29 477 160.8619	R(32)	32 550 429.1766
R(34)	29 511 066.6779	R(34)	32 583 536.6463
R(36)	29 544 196.3277	R(36)	32 615 869.7049
R(38)	29 576 545.1272	R(38)	32 647 432.2414
R(40)	29 608 108.1437	R(40)	32 678 228.3735
R(42)	29 638 880.1914	R(42)	32 708 262.4432
R(44)	29 668 855.8266	R(44)	32 737 539.0112
R(46)	29 698 029.3421	R(46)	32 766 062.8508
R(48)	29 726 394.7621	R(48)	32 793 838.9426
R(50)	29 753 945.8362	R(50)	32 820 872.4682

Table 2. Frequencies (MHz) for the 636 carbon dioxide laser.

P(50)	26 035 339.9907	P(50)	29 076 007.9206
P(48)	26 096 450.6641	P(48)	29 143 127.3150
P(46)	26 156 946.4184	P(46)	29 209 472.6217
P(44)	26 216 830.6112	P(44)	29 275 036.8793
P(42)	26 276 106.3711	P(42)	29 339 813.3299
P(40)	26 334 776.6055	P(40)	29 403 795.4269
P(38)	26 392 844.0080	P(38)	29 466 976.8408
P(36)	26 450 311.0648	P(36)	29 529 351.4663
P(34)	26 507 180.0614	P(34)	29 590 913.4283
P(32)	26 563 453.0887	P(32)	29 651 657.0881
P(30)	26 619 132.0481	P(30)	29 711 577.0488
P(28)	26 674 218.6570	P(28)	29 770 668.1612
P(26)	26 728 714.4536	P(26)	29 828 925.5288
P(24)	26 782 620.8011	P(24)	29 886 344.5126
P(22)	26 835 938.8920	P(22)	29 942 920.7360
P(20)	26 888 669.7515	P(20)	29 998 650.0890
P(18)	26 940 814.2413	P(18)	30 053 528.7321
P(16)	26 992 373.0624	P(16)	30 107 553.1003
P(14)	27 043 346.7579	P(14)	30 160 719.9062
P(12)	27 093 735.7156	P(12)	30 213 026.1432
P(10)	27 143 540.1699	P(10)	30 264 469.0880
P(8)	27 192 760.2040	P(8)	30 315 046.3033
P(6)	27 241 395.7512	P(6)	30 364 755.6398
P(4)	27 289 446.5964	P(4)	30 413 595.2373
P(2)	27 336 912.3769	P(2)	30 461 563.5271
R(0)	27 407 012.8973	R(0)	30 531 879.5457
R(2)	27 453 013.4681	R(2)	30 577 664.6182
R(4)	27 498 426.5523	R(4)	30 622 575.1932
R(6)	27 543 251.1292	R(6)	30 666 611.0177
R(8)	27 587 486.0315	R(8)	30 709 772.1308
R(10)	27 631 129.9443	R(10)	30 752 058.8623
R(12)	27 674 181.4045	R(12)	30 793 471.8321
R(14)	27 716 638.7993	R(14)	30 834 011.9476
R(16)	27 758 500.3646	R(16)	30 873 680.4025
R(18)	27 799 764.1833	R(18)	30 912 478.6740
R(20)	27 840 428.1829	R(20)	30 950 408.5203
R(22)	27 880 490.1333	R(22)	30 987 471.9773
R(24)	27 919 947.6441	R(24)	31 023 671.3556
R(26)	27 958 798.1612	R(26)	31 059 009.2364
R(28)	27 997 038.9638	R(28)	31 093 488.4680
R(30)	28 034 667.1602	R(30)	31 127 112.1610
R(32)	28 071 679.6844	R(32)	31 159 883.6838
R(34)	28 108 073.2910	R(34)	31 191 806.6579
R(36)	28 143 844.5509	R(36)	31 222 884.9524
R(38)	28 178 989.8459	R(38)	31 253 122.6787
R(40)	28 213 505.3631	R(40)	31 282 524.1845
R(42)	28 247 387.0891	R(42)	31 311 094.0480
R(44)	28 280 630.8034	R(44)	31 338 837.0715
R(46)	28 313 232.0718	R(46)	31 365 758.2751
R(48)	28 345 186.2387	R(48)	31 391 862.8896
R(50)	28 376 488.4197	R(50)	31 417 156.3497

Table 3. Frequencies (MHz) for the 828 carbon dioxide laser.

P(50)	27 702 788.3340	P(50)	31 275 461.0484
P(48)	27 763 916.5271	P(48)	31 330 648.1933
P(46)	27 824 219.8818	P(46)	31 385 304.7512
P(44)	27 883 701.5085	P(44)	31 439 427.2029
P(42)	27 942 364.3439	P(42)	31 493 012.1188
P(40)	28 000 211.1532	P(40)	31 546 056.1633
P(38)	28 057 244.5316	P(38)	31 598 556.0988
P(36)	28 113 466.9070	P(36)	31 650 508.7885
P(34)	28 168 880.5416	P(34)	31 701 911.2012
P(32)	28 223 487.5337	P(32)	31 752 760.4139
P(30)	28 277 289.8196	P(30)	31 803 053.6153
P(28)	28 330 289.1753	P(28)	31 852 788.1092
P(26)	28 382 487.2180	P(26)	31 901 961.3173
P(24)	28 433 885.4075	P(24)	31 950 570.7820
P(22)	28 484 485.0477	P(22)	31 998 614.1692
P(20)	28 534 287.2879	P(20)	32 046 089.2707
P(18)	28 583 293.1240	P(18)	32 092 994.0069
P(16)	28 631 503.3995	P(16)	32 139 326.4282
P(14)	28 678 918.8066	P(14)	32 185 084.7176
P(12)	28 725 539.8870	P(12)	32 230 267.1924
P(10)	28 771 367.0327	P(10)	32 274 872.3053
P(8)	28 816 400.4870	P(8)	32 318 898.6464
P(6)	28 860 640.3445	P(6)	32 362 344.9440
P(4)	28 904 086.5522	P(4)	32 405 210.0657
P(2)	28 946 738.9095	P(2)	32 447 493.0190
R(0)	29 009 228.1753	R(0)	32 509 824.0588
R(2)	29 049 894.0639	R(2)	32 550 648.1734
R(4)	29 089 764.2422	R(4)	32 590 887.7557
R(6)	29 128 837.8481	R(6)	32 630 542.4476
R(8)	29 167 113.8723	R(8)	32 669 612.0318
R(10)	29 204 591.1583	R(10)	32 708 096.4309
R(12)	29 241 268.4016	R(12)	32 745 995.7070
R(14)	29 277 144.1494	R(14)	32 783 310.0604
R(16)	29 312 216.8002	R(16)	32 820 039.8289
R(18)	29 346 484.6028	R(18)	32 856 185.4857
R(20)	29 379 945.6557	R(20)	32 891 747.6385
R(22)	29 412 597.9061	R(22)	32 926 727.0276
R(24)	29 444 439.1492	R(24)	32 961 124.5238
R(26)	29 475 467.0268	R(26)	32 994 941.1261
R(28)	29 505 679.0261	R(28)	33 028 177.9601
R(30)	29 535 072.4788	R(30)	33 060 836.2746
R(32)	29 563 644.5594	R(32)	33 092 917.4396
R(34)	29 591 392.2837	R(34)	33 124 422.9433
R(36)	29 618 312.5075	R(36)	33 155 354.3890
R(38)	29 644 401.9248	R(38)	33 185 713.4920
R(40)	29 669 657.0662	R(40)	33 215 502.0763
R(42)	29 694 074.2966	R(42)	33 244 722.0715
R(44)	29 717 649.8141	R(44)	33 273 375.5085
R(46)	29 740 379.6471	R(46)	33 301 464.5166
R(48)	29 762 259.6531	R(48)	33 328 991.3192
R(50)	29 783 285.5157	R(50)	33 355 958.2301

Table 4. Frequencies and wavenumbers for the $01^1_1-[11^0_0,03^0_0]_1$ band of $^{13}\text{CO}_2$.

Rot. Trans.	Frequency (MHz) ^a	Rot. Trans.	Frequency (MHz) ^a
P(50)	25 110 914.276(1909)	R(1)	26 522 359.352(307)
P(49)	25 163 452.505(1658)	R(2)	26 545 384.349(356)
P(48)	25 173 184.219(1500)	R(3)	26 568 137.000(372)
P(47)	25 223 707.197(1300)	R(4)	26 590 844.300(435)
P(46)	25 234 801.135(1157)	R(5)	26 613 344.206(446)
P(45)	25 283 388.000(1001)	R(6)	26 635 672.514(520)
P(44)	25 295 767.670(874)	R(7)	26 657 980.003(528)
P(43)	25 342 496.069(755)	R(8)	26 679 867.807(608)
P(42)	25 356 086.324(643)	R(9)	26 702 043.339(622)
P(41)	25 401 032.476(555)	R(10)	26 723 428.851(700)
P(40)	25 415 759.456(459)	R(11)	26 745 533.080(728)
P(39)	25 458 998.211(395)	R(12)	26 766 354.173(792)
P(38)	25 474 789.277(315)	R(13)	26 788 448.007(850)
P(37)	25 516 394.177(271)	R(14)	26 808 642.157(885)
P(36)	25 533 177.855(206)	R(15)	26 830 786.820(992)
P(35)	25 573 221.199(177)	R(16)	26 850 291.041(979)
P(34)	25 590 927.113(127)	R(17)	26 872 548.133(1159)
P(33)	25 629 480.014(109)	R(18)	26 891 298.919(1072)
P(32)	25 648 038.830(72)	R(19)	26 913 730.480(1356)
P(31)	25 685 171.278(62)	R(20)	26 931 663.740(1167)
P(30)	25 704 514.640(39)	R(21)	26 954 332.308(1589)
P(29)	25 740 295.564(33)	R(22)	26 971 383.309(1267)
P(28)	25 760 356.034(24)	R(23)	26 994 351.983(1865)
P(27)	25 794 853.362(22)	R(24)	27 010 455.287(1377)
P(26)	25 815 564.357(21)	R(25)	27 033 787.788(2192)
P(25)	25 848 845.075(21)	R(26)	27 048 877.189(1503)
P(24)	25 870 140.808(21)	R(27)	27 072 637.922(2577)
P(23)	25 902 271.029(20)	R(28)	27 086 646.387(1656)
P(22)	25 924 086.446(20)	R(29)	27 110 900.501(3027)
P(21)	25 955 131.461(18)	R(30)	27 123 760.107(1847)
P(20)	25 977 402.180(20)	R(31)	27 148 573.557(3552)
P(19)	26 007 426.528(18)	R(32)	27 160 215.432(2089)
P(18)	26 030 088.780(21)	R(33)	27 185 655.039(4159)
P(17)	26 059 156.302(20)	R(34)	27 196 009.301(2394)
P(16)	26 082 146.866(21)	R(35)	27 222 142.814(4856)
P(15)	26 110 320.773(28)	R(36)	27 231 138.505(2775)
P(14)	26 133 576.918(20)	R(37)	27 258 034.663(5653)
P(13)	26 160 919.848(39)	R(38)	27 265 599.695(3242)
P(12)	26 184 379.270(22)	R(39)	27 293 328.288(6559)
P(11)	26 210 953.348(55)	R(40)	27 299 389.374(3806)
P(10)	26 234 554.110(33)	R(41)	27 328 021.302(7584)
P(9)	26 260 421.015(76)	R(42)	27 332 503.902(4475)
P(8)	26 284 101.484(57)	R(43)	27 362 111.241(8736)
P(7)	26 309 322.503(103)	R(44)	27 364 939.495(5260)
P(6)	26 333 021.291(91)	R(45)	27 395 595.552(****)
P(5)	26 357 657.387(136)	R(46)	27 396 692.223(6167)
P(4)	26 381 313.287(134)	R(47)	27 428 471.603(****)
P(3)	26 405 425.156(176)	R(48)	27 427 758.013(7208)
P(2)	26 428 977.084(187)	R(49)	27 460 736.676(****)
		R(50)	27 458 132.647(8390)

a) The number in parentheses is the estimated 1- σ uncertainty in the last digits.

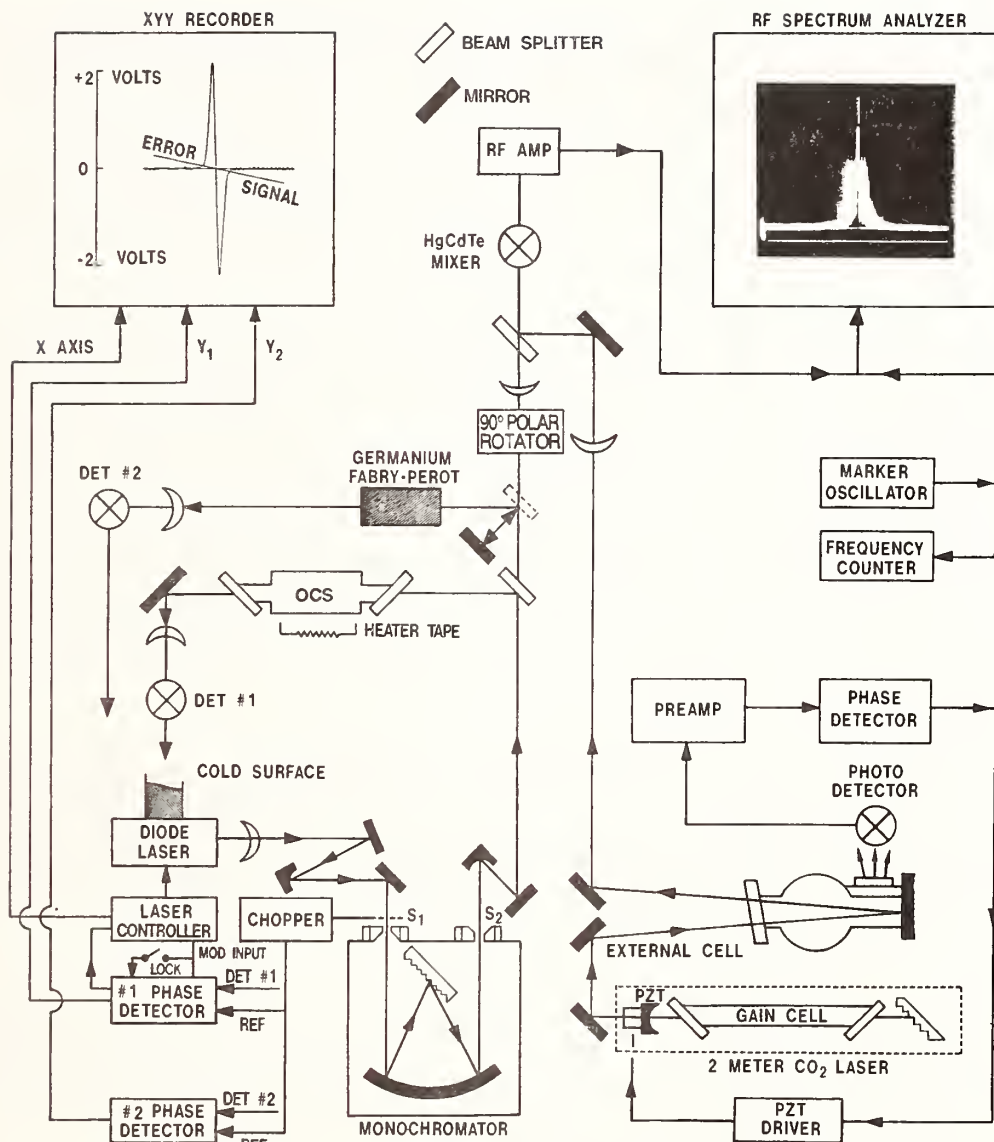

Fig. 2. Block diagram of scheme used for heterodyne measurements with a CO₂ laser.

As the demand for TDLs increased, vendors began experiencing difficulties in growing semiconductors that would meet the customers' specified frequency region while operating in the 4 to 10 K range. The materials problem became more tractable as the temperature constraint was removed by selling to the customers closed-cycle coolers with 10 to 70 K operating capabilities. Soon it became nearly impossible to obtain TDLs operable at helium temperatures. Most of our measurements were made using a closed-cycle cooler. This was an improvement in many areas, however in spite of an isolation scheme, some residual vibrations from the cooler's piston were transmitted to the TDL, resulting in the famous jitter linewidth which is familiar to all TDL users. The vendor has made two additional isolation improvement schemes available and while these appear worthwhile, they are still not the ultimate solution.

Currently, the NIST liquid helium Dewar has been modified to accommodate a four-laser mounting platform (including the heater coils and temperature sensing diodes) from a closed-cycle

cooler. While helium consumption is too high for most of the TDLs available to us, this does offer promise with the recent advent of the higher temperature MBE (molecular beam epitaxy) TDLs. A few of these are now available and operate in the temperature range accessible with liquid nitrogen (70 K to 120 K if a heater is available).

Both the Dewar and closed-cycle refrigerator are interchangeable in that they were compatible with the laser control module (current controller) and temperature control system. Both the control module and temperature controller have also been upgraded to reduce current noise and temperature instabilities; these upgrades have proved worthwhile. The particular type of refrigeration is not specified in Fig. 2.

After passing through the AR-coated ZnSe window of the refrigeration stage, the TDL radiation was collimated with an AR-coated $f/1$ lens and directed with a flat mirror and off-axis parabolic mirror into a 0.8 m Ebert-Fastie monochromator. A second off-axis parabolic mirror recollimated the TDL beam after it emerged from the monochromator. A portion of the beam was split off and passed through an absorption cell (containing the molecule of interest, N_2O in this case) to a detector which was used initially in recording the spectra and later for the TDL locking procedure. The monochromator and a solid three inch germanium etalon were used to help identify the particular molecular transition of interest. Once the transition had been identified, the kinematic mirror mount directing the TDL beam through the etalon was removed and the TDL beam was then focused on the HgCdTe mixer element. At this time, both the entrance and exit slits were removed from the monochromator, in order to eliminate the fringes or channel spectra which the slits may cause via feedback to the laser.

At this point in the procedure, it was useful to measure the TDL linewidth by heterodyning its output with that from a CO_2 laser (or CO laser as described in the next section). TDL linewidths of several hundred megahertz are not uncommon at higher currents (higher gains) when viewed for integration times of several seconds. Next, the current was reduced (while increasing the temperature to maintain frequency) until an acceptable (10 to 30 MHz), or at least the narrowest attainable, linewidth was achieved for a measurement.

TDL Locking Procedure and Minimization of Error

Assuming the best conditions, that is, a strong TDL (0.5 mW for example) with a single mode that has a flat power versus wavelength curve, a narrow TDL linewidth, and a well isolated and intense line for a locking reference, we could likely make a measurement with an uncertainty of less than 1 MHz. While these conditions sometimes prevail, more often, they do not.

It is germane to discuss here the TDL locking procedure and some of the ways we have minimized errors that can creep into a measurement. After the chopper was removed from the TDL beam path, the TDL was frequency-modulated at 4.5 kHz and a first derivative scheme was used to lock the TDL frequency. In this procedure, the frequency of the radiation output of the TDL was tuned from well below the molecular transition to well above it, and the resulting derivative signal (including the baseline and the absorption line) was traced by the recorder. (See derivative trace in the xyy recorder box in Fig. 2.) The frequency was returned to the low value and then the recorder signal monitored as the trace was followed to the derivative midpoint for locking. [Note: The derivative trace in Fig. 2 has a line labeled "error signal" superimposed on it. This error signal was recorded while scanning the TDL current both up and down while the laser was locked with moderate gain. For "infinite gain" the line becomes horizontal, or zero volts everywhere; for nearly zero gain, the line has a slope near that of the derivative signal. The slope of the error signal may be chosen (by adjusting the loop gain) to any value between these limits. By proper adjustments of the gain value and the TDL current the TDL may be "locked" (or stabilized) to nonzero values.] A low gain was used in the lock loop and the recorder pen position was monitored during the measurement. One of the reasons for this was that the TDL mode generally was not flat over the region of the line of

interest. Rather than locking the TDL to the zero-voltage point, the TDL frequency was locked to a point where the derivative signal crossed the existing baseline derivative. The sources of error to be avoided are not only sloping background (with resultant zero offset in the derivative signal), but also possible instrumental zero offsets from the lock-in amplifier. Both sources become magnified when dealing with weaker TDL modes or low level absorption and a very high sensitivity on the lock-in amplifier, and the procedure outlined above was essential.

Since the background slopes may have either sign and compensation for zero offsets may be either too large or too small, these errors are random when spread over measurements of several different lines. In the case of strong absorption lines and a powerful TDL mode, the difference between the lock point and 0 V was generally negligible compared to other sources of error.

Another obvious source of error in determining the location of the center of the molecular absorption line was noise. In addition to TDL amplitude fluctuations and detector noise, feedback fringes or channel spectra are also included, although some of amplitude noise can be attributable to feedback. Several techniques were used to minimize sources of error. The frequency of the TDL modulation was chosen to be higher than that of the TDL amplitude fluctuations and higher than the upper frequency of typical detector noise. The usual techniques for fringe reduction, including the monochromator slit removal alluded to earlier, tilting of various optical elements in the TDL beam path (particularly the detectors) were all employed. Cells of absorbing gases (for isolation) were placed in the TDL beam path in a few instances although it was not possible for most spectral regions.

Measurement of the Difference Frequency between the TDL and Gas (CO₂ or CO) Laser

The portion of the TDL beam passing through the first beam splitter in Fig. 2 has its polarization rotated by 90° to be parallel to the gas laser beam polarization. (The TDL polarization was assumed to be in the plane of the junction; however, a sizeable perpendicular component may also exist.) The TDL beam was then focused (typically, FL = 12.5 cm) through a second beam splitter onto the HgCdTe fast detector or mixer which had an element with an area of 0.1 mm². The 3 dB bandwidth of this detector was 1 GHz. Power from the gas laser was focused with a 40 cm focal length lens and then reflected off the beam splitter (NaCl was chosen to keep the local oscillator power below 10 mW) in such manner as to make the gas laser beam collinear with the TDL beam and to make the beam waists coincide.

After initial observation of the beatnote, the amplitude was maximized by fine adjustment of the focusing lenses. It was also necessary to ascertain that the beatnote observed on the spectrum analyzer was the one of interest. This was particularly relevant when using the CO laser. On some occasions, the first beatnote observed was due to the TDL radiation mixing with that from a nearby unintended CO transition which could not be prevented from lasing along with the CO transition of interest. Multimode TDLs are also the source of extraneous beatnotes.

Once we determined that the observed beatnote was the one of interest, the TDL frequency was scanned by changing the current and the beatnote was followed on the spectrum analyzer from zero frequency up (or down) to the molecular feature to be measured. The scan rate was reduced to a lower value and the progress of the beatnote carefully monitored relative to the derivative signal. The TDL frequency was then locked to the desired point on the derivative signal which was displayed on the recorder. The beatnote was then averaged with the persistent screen averaging feature of the spectrum analyzer, and a marker oscillator was adjusted to the center of this averaged display. (A representative beat note is shown in the right hand portion of Fig. 2. Here the frequency span of the spectrum analyzer display was 100 MHz.) The marker oscillator frequency was counted and the measurement repeated a number of times (10 to 20, depending on the reproducibility of the measurements).

Minimization of the Difference Frequency Uncertainties

Ideally, the best method to determine the difference frequency between the TDL and the gas laser would be to use an electronic counter. However, the signal-to-noise ratio (S/N) of the beatnote and the frequency modulation associated with the cold head and compressor generally precluded this approach. The next best approach is that described in the preceding paragraph.

The best measurements were those made with a liquid helium Dewar; the beatnote was essentially stationary on the spectrum analyzer. However, the rapid He consumption rates for higher temperature TDLs made this choice impractical as well as inconvenient. When the compressor was used, the beatnote had a jitter linewidth associated with it and its frequency fluctuations made determination of the beatnote center more difficult. A wide variation of jitter linewidths from many different TDLs has been observed over an extended period. The current tuning rates (60 to 1600 MHz/ma) and linewidths due to current noise vary widely from one TDL to another. In a similar fashion the jitter linewidth varies greatly from one laser to the next, due to varying sensitivity to vibrations associated with the compressor/coldhead. Sometimes an apparent jitter linewidth was due to feedback, however this was generally recognized and steps were taken to minimize it. Beatnotes ranging in width from a few megahertz (10 μm TDLs in a liquid helium Dewar) to 60 to 100 MHz (6 μm TDLs in a closed-cycle cooler) were observed during the measurements. However the larger values (in the 5 to 6 μm region) were observed prior to the currently implemented improvements in the vibration isolation system. The most recent approach was to adjust the current modulation for the derivative lock such that the beatnote linewidth was not broadened beyond the jitter linewidth. (This was subject to retention of a suitable S/N for the lock signal.)

The frequency-modulated beatnote was observed at a repetitive rate on the spectrum analyzer.

The pulse rate of the closed-cycle cooler was asynchronous with both the modulation rate and the spectrum analyzer sweep rate. As a result, the beatnote observed on the spectrum analyzer made small and slowly varying excursions about an average value. This led to some scatter in the measured value for the beatnote center frequency. Some experiments were conducted to check the compressor-induced fluctuations as a source of systematic error. Typically, 20 measurements were made with the compressor on, and the marker oscillator frequency was adjusted to the resultant average value. The TDL lock point was then rechecked and the compressor was turned off (eliminating the jitter from the beatnote) momentarily. The jitter-free beatnote was observed for a few seconds in this configuration. To date no appreciable deviation of the jitter-free beatnote from the marker oscillator has been observed.

On some occasions, the beatnote envelope was slightly asymmetric. Generally, two different operators have determined the center value and some subjective disagreement was apparent. In a recent set of measurements of 20 transitions the average value of 10 measurements each from two operators varied by 2.5 MHz. This was well within the assigned uncertainty of 7 MHz for the measurement. More often, the average values from different operators agree within a fraction of 1 MHz.

Another difficulty in these measurements was the presence of "holes" in the frequency coverage of the detector-rf-amplifier combination. In some instances, these frequency holes were associated with connector lengths and their effect could be minimized (by moving the hole to another frequency) by using line stretchers or by changing cables. Some holes were associated with lengths of connecting elements in the detector, and for practical purposes could not be eliminated. In other cases, holes were associated with amplifiers themselves; sometimes they precluded making measurements. In a few instances shallow holes have led to systematic errors. This occurred when only very weak TDL modes were available and the S/N for the beatnote was small (3 to 4 dB for example). Often the beatnote envelope was fairly wide (50 MHz or greater). In cases like these, one side of the beatnote envelope can overlap a hole and the apparent line center will be shifted. This has happened in a few instances but the error was apparent in the fitting process. In these cases, a repetition of the measurement with

a different TDL and a much stronger beatnote gave a different and better fitting result. Such holes generally remain at the same frequency and experience has shown which frequency regions to avoid.

Measurements with a CO Laser Transfer Oscillator and CO₂ Laser Synthesizer

Near the inception of this program, a CO laser stabilization scheme on low pressure CO laser discharges had been demonstrated by Freed [2.13]. More recently, a stabilization scheme using optogalvanic detection has been reported by Schneider *et al.* [2.14]; neither of these schemes was operable over the entire range required for our measurements. Some values of CO frequencies in the literature (available when the measurements in this region began) were in error by over 50 MHz. Since the goal of this measurement program was to be able to make measurements with a 3 MHz uncertainty, it was necessary to measure the frequency of the CO laser at the same time that the CO laser-TDL difference frequency measurements were made on N₂O and OCS transitions. This process required the use of the CO laser as a transfer oscillator, and the CO laser frequency was measured relative to a frequency generated by a CO₂ laser synthesizer [5.94, 5.221, 2.15].

Two different CO lasers were used in this manner. One was a sealed-off laser which was cooled by flowing alcohol through dry ice and then through a jacket around the discharge tube. This operated over the frequency range from 1600 to 1900 cm⁻¹ (corresponding to lower vibrational quantum numbers ranging from $v'' = 20$ to $v'' = 6$). The second CO laser was a flowing gas laser which was cooled by liquid-nitrogen and operated from 1220 to 1600 cm⁻¹ ($v'' = 36$ to $v'' = 20$). After installation of a shorter wavelength grating and an appropriate output mirror, operation was extended to the 1900 to 2080 cm⁻¹ region ($v'' = 6$ to $v'' = 1$). Additional details regarding the liquid-nitrogen cooled CO laser may be found in the literature [5.125, 5.224, 5.231].

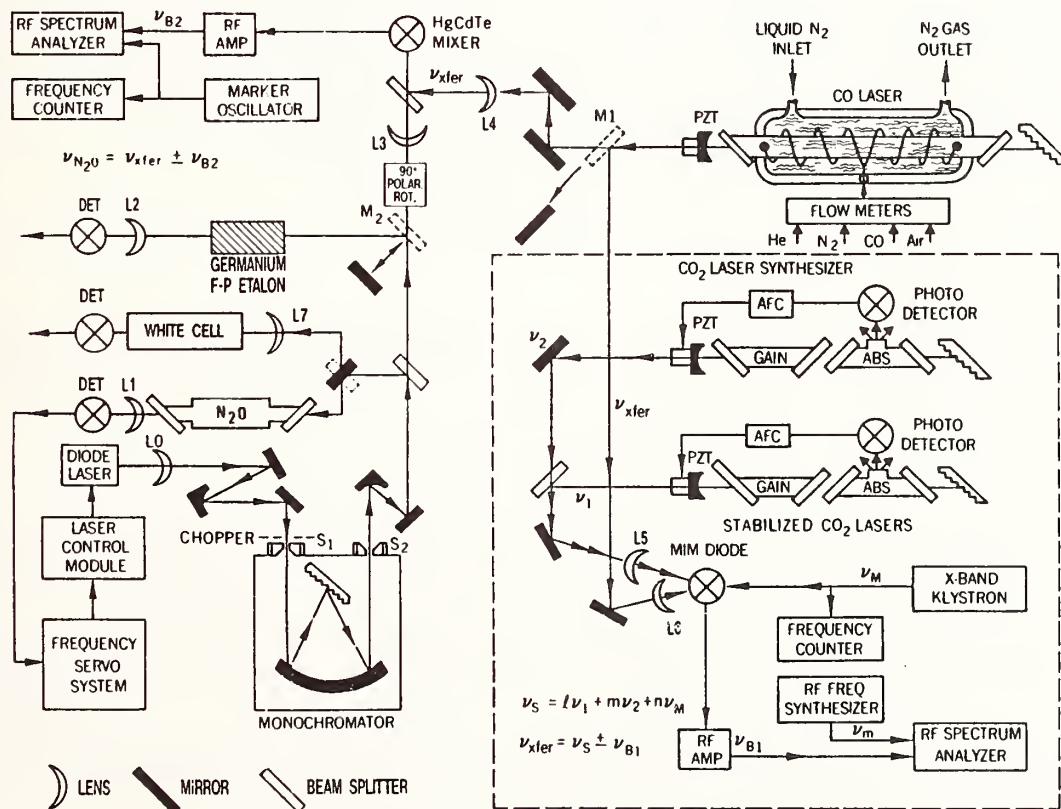

Fig. 3. Block diagram of scheme used to make heterodyne frequency measurements with a CO laser. The CO₂ laser synthesizer is shown in the dashed box.

Figure 3 shows a block diagram for making frequency measurements with the CO laser. The dashed outline shows the kinematically mounted mirror, M_1 , in position for measuring the CO laser frequency relative to the CO_2 synthesizer, which is shown enclosed in the large dashed box. The synthesizer consists of two stabilized CO_2 lasers, a phase-locked microwave oscillator and frequency counter, a metal-insulator-metal (MIM) diode, and a combination of an rf amplifier, rf spectrum analyzer, and a 0 to 1.0 GHz rf frequency synthesizer. When radiation from the two CO_2 lasers and the microwave oscillator were coupled to the MIM diode, currents were generated at a synthesized frequency, ν_s , given by

$$\nu_s = \ell\nu_1 + m\nu_2 + n\nu_M,$$

where ν_1 and ν_2 were the frequencies of the CO_2 laser frequency standards, and ν_M was a microwave frequency. The quantities ℓ , m , and n are integers which are allowed both positive and negative values. The quantity $[1 + |\ell| + |m| + |n|]$ is called the mixing order; the synthesized currents generally become weaker as the mixing order is increased. Mixing orders vary from 3 or 4 near 50 THz to 7 or 8 near 38 THz, the frequency at the longest wavelength operation of the CO laser used in these measurements. Typical values might be $\ell = 3$ or 4, $m = -2$ or -3 , and (with the use of an X-band klystron) n was restricted to 0, ± 1 , or ± 2 .

When the CO laser radiation was focused on the MIM diode, an additional current at the CO laser frequency, ν_{CO} , was generated in the diode and it combined with the synthesized frequency, ν_s , to produce a difference frequency beatnote at a frequency, ν_{B1} . (The microwave frequency was chosen so that this beatnote was within the 1.2 GHz range of the spectrum analyzer in use.) The beatnote was amplified, displayed on the spectrum analyzer, and its excursion was noted as the CO laser was tuned through its gain bandwidth. The beatnote was positioned at the center of this excursion (a determination of the frequency of the CO transition was a secondary objective) and a marker signal from the rf synthesizer was used to mark this frequency point on the spectrum analyzer. The rf synthesizer reading was then used as the value for ν_{B1} and the CO laser (which was not locked) was periodically readjusted to return the beatnote to the assigned frequency.

The frequency of the CO laser (transfer oscillator) was then

$$\nu_{\text{CO}} = \nu_{\text{transfer}} = \nu_s \pm \nu_{\text{B1}}.$$

The full accuracy of CO_2 frequencies was used for the ν_s calculation. An uncertainty of 0.3 MHz (which includes allowance for drift between readjustments) in the transfer oscillator was included in the measurement uncertainty of the molecular transition, which was given by

$$\nu_{\text{mol}} = \nu_{\text{transfer}} \pm \nu_{\text{B2}},$$

where ν_{B2} was the beatnote between the TDL and the transfer oscillator. The transfer oscillator frequency and beatnote frequency are both rounded to the nearest 0.1 MHz. The main uncertainty was again due to the TDL linewidth which was discussed in the early part of the chapter.

The most recent advance in making heterodyne frequency measurements with TDL's involves a computer-controlled, frequency offset-locking (CCFOL) scheme. Freed *et al.* [2.16] demonstrated the use of a frequency offset lock combined with a frequency synthesizer to control the output frequency of the TDL. We have combined that technique with the scanning and data-logging technology used in this laboratory for other measurements [2.17-2.19] to obtain accurate data on $d\nu/dP$, the pressure-induced frequency shifts, in the rovibrational spectrum of OCS. The potential for better absolute frequency measurements was also demonstrated.

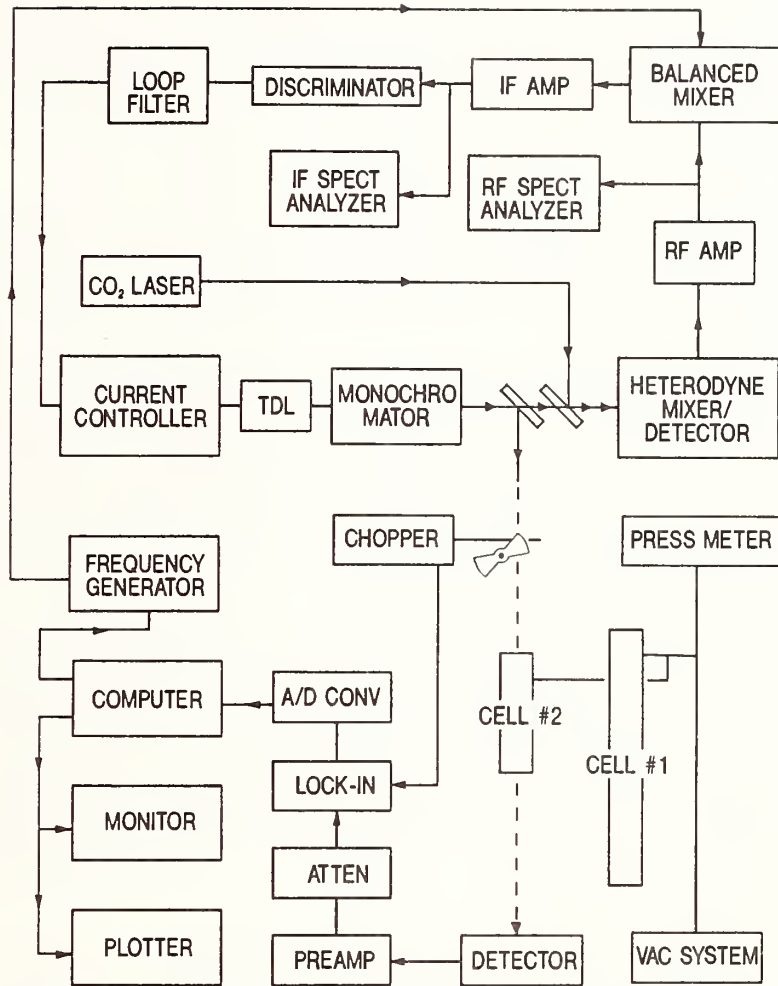

Fig. 4. Block diagram of a computer controlled frequency offset-locked spectrometer.

Figure 4 shows a block diagram of the apparatus used for this type of measurement. The output beams from a TDL and a CO₂ laser frequency standard were focused with separate lenses and then combined with a ZnSe beam splitter and directed to a HgCdTe heterodyne mixer/detector which produced a beatnote at the difference frequency, ν_B , between the two lasers. The beatnote was amplified in an rf amplifier and displayed on an rf spectrum analyzer. A balanced mixer was used to down-convert the beatnote at frequency ν_B to a nominal 160 MHz, the region of operation of the IF amplifier and discriminator. The beatnote was fed to one input arm of the balanced mixer, and the output of the sweepable frequency generator, at frequency ν_{sw} , was fed to the other input arm (the local oscillator arm). The frequency ν_{sw} was adjusted such that $|\nu_{sw} - \nu_B|$ was nominally 160 MHz, and this resulting output signal was fed to the discriminator which had a sensitivity of 0.1 V/MHz and an 80 MHz bandwidth.

After the switch in the loop filter was closed, the discriminator-based locking loop adjusted the TDL frequency to insure that the beatnote ν_B was locked at a frequency ν_{DO} away from ν_{sw} . That is,

$$\nu_{DO} = |\nu_{sw} - \nu_B|,$$

where ν_{DO} is close but (due to the presence of various zero offsets in the locking loop) not necessarily equal to 160 MHz. For frequency shift and lineshape measurements, the important point is that the frequency ν_{DO} must remain fixed, whatever value it assumes. If a frequency measurement is the objective, it becomes necessary to measure ν_{DO} . Frequency of the CCFOL TDL is then given by

$$\nu_{\text{TDL}} = \nu_{\text{CO}_2} \pm \nu_{\text{sw}} \pm \nu_{\text{DO}}.$$

Two frequency measurements were made with an uncertainty of ± 2 MHz, which was almost entirely due to the TDL linewidth. By narrowing the TDL linewidth with a faster loop filter, one should be able to use an electronic counter to measure ν_{DO} and make measurements with uncertainties the order of 0.2 MHz.

We have restricted our initial experiments to those OCS transitions which lie within 2000 MHz of a CO_2 laser transition because the lock loop requires a beatnote with a good S/N and the beatnote signal decreases with increasing frequency. This is also the band limit of our most convenient rf amplifier. We chose from the available TDLs those with sufficient power to give a beatnote with a S/N of about 30 dB. For the present measurements a 400 ms integration time was used and 640 points were recorded in each direction. Recording in both directions is a good way to cancel certain types of systematic errors. Generally only one round trip pass was made per measurement but as many passes could be made as required to give a good S/N.

A large number of measurements have been made with the older technique and these have been combined with FTS measurements, particularly the high quality measurements made recently. As the situation stands now good molecular constants exist, with the band centers currently having the largest uncertainties. The number of measurements left to be made is a relatively small number of high quality. The best approach is to make sub-Doppler or saturated measurements, however, the accidental overlaps required are rather infrequent. We believe the CCFOL approach is the next best option and several strategic overlaps occur in the 2 GHz range.

Measurements with the Color Center Laser

Pollock *et al.* [5.219] used a color center laser (CCL) to perform a set of experiments on N_2O . A brief description of their work and some related work concludes the summary of heterodyne techniques. It is of interest to compare and contrast some of the salient features of the TDL and the CCL. The tuning range of a TDL mode was 15 to 30 GHz; that of the CCL was less than 1 GHz. The linewidth of the TDL in the best instances was a few MHz, that of the CCL was 10 kHz. Perhaps the most important feature of the CCL was a large power output (in excess of 10 mW), which along with its beam quality permitted a direct coupling of the CCL output to the MIM diode, and subsequent synthesis measurements without a transfer oscillator. This relatively large power and narrow linewidth made it an ideal tool to use for some saturated absorption measurements by Pollock *et al.* on CO [5.304]. Sub-Doppler measurements could not be made on the N_2O band studied, and uncertainties of 4 to 8 MHz (at 130 to 140 THz) were reported. This uncertainty was due to the uncertainty in locating the center of the transition and was due in part to the small free spectral range of the tuning element of the CCL, which frequently prevented us from sweeping over the entire line and was also insufficient to sweep far enough on either side of an absorption line to determine a background slope.

Shown in Fig. 5 is a block diagram of the ring configuration color center laser developed by Pollock and Jennings [2.20]. The lasing entity in the lithium-doped potassium chloride crystal was an $(\text{F}^+)_A$ center. The centers were optically pumped with the 3 W power output from an Nd:YAG laser operating in a TEM_{00} mode at 1.3 μm . These color centers were continuously replenished by uv radiation from a Hg lamp.

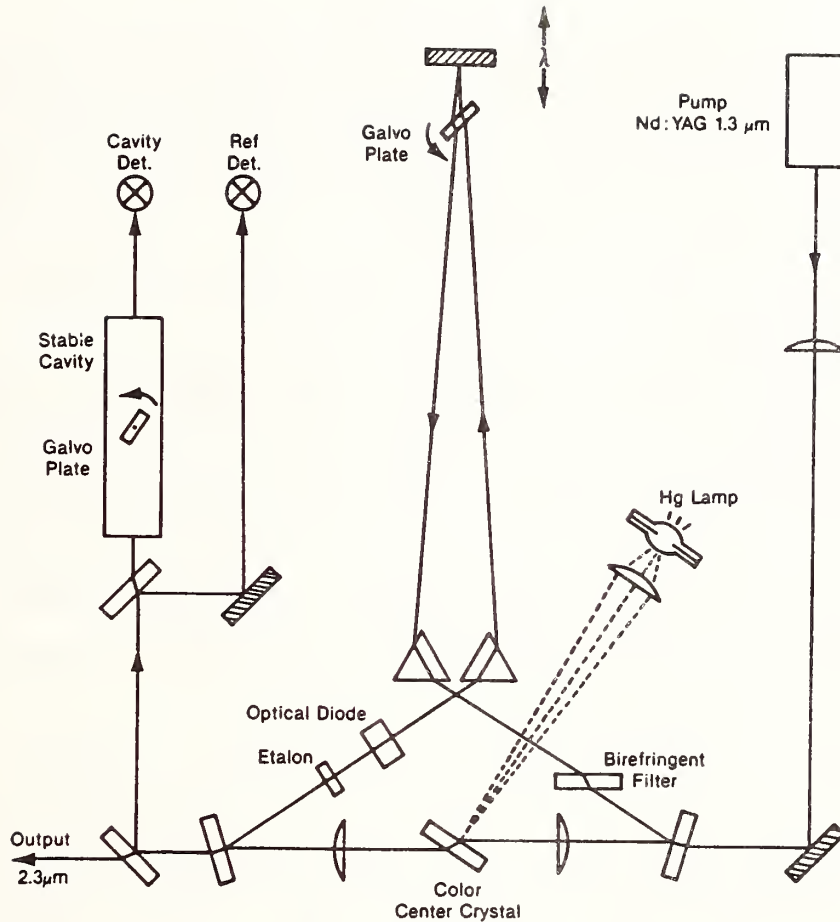

COLOR CENTER RING LASER

Fig. 5. Block diagram of color center laser in ring configuration.

Two Brewster's angle sapphire prisms, a single plate birefringent filter and one etalon comprised the tuning elements. The ring was constrained to operate in a unidirectional manner by an optical diode consisting of an AR-coated YIG plate in a 0.1 tesla magnetic field and a Brewster-cut quartz plate reciprocal rotator. One portion of the output radiation was used for stabilization to the side of a fringe in a passively stabilized optical cavity. The cavity was scanned by tuning a Galvo plate inside this reference cavity. Corrections were applied to the Galvo plate (slow) and to the PZT driving the tuning mirror (fast) in the laser resonator; this narrowed the CCL linewidth to 10 kHz. A second portion of the beam was split off and sent through a cell containing CO. The Galvo plate in the reference cavity was modulated at 7 kHz and slowly scanned to observe the first derivative signal, which was used to lock the CCL to the CO lines of interest.

A third portion of the CCL radiation was directed to the CO₂ synthesizer (more specifically the MIM diode portion) for a simultaneous measurement of the CO frequency. Typical synthesis schemes used $5\nu_1$, $4\nu_1 + \nu_2$, or $3\nu_1 + \nu_2$, where ν_1 and ν_2 are different CO₂ laser frequencies. No microwave oscillators were required, and the ν_{B1} type beatnotes fell within 2 GHz. In contrast to the TDL measurements, the measurement uncertainty was entirely the uncertainty in locating the center of the absorption line.

References

- [2.1] K. M. Evenson, J. S. Wells, F. R. Petersen, B. L. Danielson, and G. W. Day, "Accurate frequencies of molecular transitions used in laser stabilization: the 3.39- μm transition in CH_4 and the 9.33- and 10.18- μm transitions in CO_2 ," *Appl. Phys. Lett.* **22**, 192-196 (1973).
- [2.2] C. Freed and A. Javan, "Standing-wave saturation resonances in the CO_2 10.6- μm transitions observed in a low pressure room temperature absorber gas," *Appl. Phys. Lett.* **17**, 53-56 (1970).
- [2.3] R. L. Barger and J. L. Hall, "Wavelength of the 3.39- μm laser saturated absorption line of methane," *Appl. Phys. Lett.* **22**, 196-199 (1973).
- [2.4] K. M. Evenson, J. S. Wells, F. R. Petersen, B. L. Danielson, G. W. Day, R. L. Barger, and J. L. Hall, "Speed of light from direct frequency and wavelength measurements of the methane-stabilized laser," *Phys. Rev. Lett.* **29**, 1346-1349 (1972).
- [2.5] F. R. Petersen, D. G. McDonald, J. D. Cupp, and B. L. Danielson, "Accurate rotational constants, frequencies and wavelengths from $^{12}\text{C}^{16}\text{O}_2$ lasers stabilized by saturated absorption," *Laser Spectroscopy*, (ed. Brewer and Mooradian) Plenum Press, pp. 555-569 (1974).
- [2.6] D. A. Jennings, R. E. Drullinger, K. M. Evenson, C. R. Pollock, and J. S. Wells, "The continuity of the meter: the redefinition of the meter and the speed of light," *J. Res. NBS* **92**, 11-16 (1987).
- [2.7] C. R. Pollock, D. A. Jennings, F. R. Petersen, J. S. Wells, R. E. Drullinger, E. C. Beaty, and K. M. Evenson, "Direct frequency measurements of transitions at 520 THz (576 nm) in iodine and 260 THz (1.15 μm) in neon," *Opt. Lett.* **3**, 133-135 (1983).
- [2.8] D. A. Jennings, C. R. Pollock, F. R. Petersen, R. E. Drullinger, K. M. Evenson, J. S. Wells, J. L. Hall, and H. P. Layer, "Direct measurement of the I_2 stabilized He-Ne 473 THz (633 nm) laser," *Opt. Lett.* **3**, 136-138 (1983).
- [2.9] F. R. Petersen, E. C. Beaty, and C. R. Pollock, "Improved rovibrational constants and frequency tables for the normal laser bands of $^{12}\text{C}^{16}\text{O}_2$," *J. Mol. Spectrosc.* **102**, 112-122 (1983).
- [2.10] L. C. Bradley, K. L. Soohoo, and C. Freed, "Absolute frequencies of lasing transitions in nine CO_2 isotopic species," *IEEE J. Quant. Elect.* **QE-22**, 234-267 (1986).
- [2.11] F. R. Petersen, J. S. Wells, A. G. Maki, and K. J. Siemsen, "Heterodyne frequency measurements of $^{13}\text{CO}_2$ laser hot band transitions," *Appl. Opt.* **20**, 3635-3640 (1981).
- [2.12] F. R. Petersen, J. S. Wells, K. J. Siemsen, A. M. Robinson, and A. G. Maki, "Heterodyne frequency measurements and analysis of $^{12}\text{C}^{16}\text{O}_2$ laser hot band transitions," *J. Mol. Spectrosc.* **105**, 324-330 (1984).
- [2.13] C. Freed and H. A. Haus, "Lamb dip in CO lasers," *IEEE J. Quant. Elect.* **QE-9**, 219-226 (1973).
- [2.14] M. Schneider, A. Hinz, A. Groh, K. M. Evenson, and W. Urban, "CO laser stabilization using the optogalvanic Lamb-dip," *Appl. Phys.* **B44**, 241-245 (1987).
- [2.15] J. S. Wells, D. A. Jennings, and A. G. Maki, "Improved deuterium bromide 1-0 band molecular constants from heterodyne frequency measurements," *J. Mol. Spectrosc.* **107**, 48-61 (1984).
- [2.16] C. Freed, J. W. Bielinski, and W. Lo, "Programable secondary frequency standard based infrared synthesizer using tunable lead-salt lasers," *Proc. SPIE* **438**, 119-124 (1984).
- [2.17] K. M. Evenson, D. A. Jennings, and F. R. Petersen, "Tunable far-infrared spectroscopy," *Appl. Phys. Lett.* **44**, 576-578 (1984).
- [2.18] D. A. Jennings, "The generation of coherent tunable far infrared radiation," *Appl. Phys.* **B48**, 311-313 (1989).
- [2.19] D. A. Jennings, K. M. Evenson, M. D. Vanek, I. G. Nolt, J. V. Radostitz, and K. V. Chance, "Air- and oxygen-broadening coefficients for the O_2 rotational line at 60.46 cm^{-1} ," *Geophys. Res. Lett.* **14**, 722-725 (1987) and "Correction: Air- and oxygen-broadening coefficients for the O_2 rotational line at 60.46 cm^{-1} ," *Geophys. Res. Lett.* **14**, 981 (1987).
- [2.20] C. R. Pollock and D. A. Jennings, "High Power cw Laser Operation Using $(\text{F}^+)_A$ Color Centers," *Appl. Phys.* **B28**, 308-309 (1982).

CHAPTER III

FORMULAS AND DATA SOURCES USED TO PREPARE THE TABLES

Expressions Used for Fitting the Frequency Data and for Calculating the Transition Wavenumbers

For diatomic molecules and for linear triatomic molecules in ${}^1\Sigma$ electronic states the energy levels are generally given by

$$E_{vJl} = G_v + B_v J(J+1) - D_v [J(J+1) - l^2]^2 + H_v [J(J+1) - l^2]^3 + L_v [J(J+1) - l^2]^4 + \text{higher terms}, \quad (3.1)$$

where J is the quantum number for overall rotational angular momentum and l is the quantum number for vibrational angular momentum. Diatomic molecules have no vibrational angular momentum; that is, $l = 0$. In this work no higher order terms were needed and even the H_v and L_v terms were either poorly determined or not determinable.

For diatomic molecules, an alternative formulation is often given for the energy levels,

$$E_{vJ} = \sum_{ij} Y_{ij} (v + 1/2)^i [J(J+1)]^j. \quad (3.2)$$

Dunham [3.1] has related the Y_{ij} constants to the potential function of a diatomic molecule in a ${}^1\Sigma$ state. Most of the papers reporting constants for CO use Eq. (3.2). The ground state of the NO molecule is a ${}^2\Pi$ state and is treated differently [5.371].

Transitional frequencies, ν_{calc} , are calculated as differences between energy levels

$$\nu_{\text{calc}} = E_{vJl'} - E_{vJl''}. \quad (3.3)$$

In this book the band centers, ν_0 , are defined by

$$\nu_0 = G_v' - G_v''. \quad (3.4)$$

For linear triatomic molecules two types of perturbations are commonly encountered that affect the importance of higher order terms in Eq. (3.1), l -type resonance and Fermi resonance. Because it has a large effect on the centrifugal distortion constants, l -type resonance was treated explicitly in the analysis of the OCS and N_2O spectra. Both l -type doubling and l -type resonance are manifestations of the same matrix element that couples levels that differ only in the value of the l quantum number, where l is treated as a signed quantum number. In this book, both effects are treated under the general title of l -type resonance. If the bending vibrational quantum number, ν_2 , is greater than zero, l -type resonance will be present and is usually noticeable.

When $\nu_2 \neq 0$, the l -type resonance was taken into account by diagonalizing the energy matrix which includes the matrix elements coupling l levels with $l \pm 2$ levels. The form of these matrices has been described in Refs. [5.120] and [3.2] but we shall repeat that description for a specific case.

For $\nu_2 = 3$, there are four possible values of l , $l = 3$, $l = 1$, $l = -1$, and $l = -3$. The l -doubling constant, q_v , represented by

$$q_v = q_v^0 - q_{vJ} J(J+1) + q_{vJJ} J^2 (J+1)^2, \quad (3.5)$$

couples these levels through the matrix element

$$W_{l-2,l} = W_{l,l-2} = \langle v,l | H | v,l-2 \rangle = \frac{1}{4} q_v \{ [v_2+l] [v_2-l+2] \\ \times [J(J+1) - l(l-1)] [J(J+1) - (l-1)(l-2)] \}^{1/2}. \quad (3.6)$$

For each J level the form of the energy matrix for $v_2 = 3$ is

$$\begin{vmatrix} E^0(v,l=3) & W_{3,1} & 0 & 0 \\ W_{1,3} & E^0(v,l=1) & W_{1,-1} & 0 \\ 0 & W_{-1,1} & E^0(v,l=-1) & W_{-1,-3} \\ 0 & 0 & W_{-3,-1} & E^0(v,l=-3) \end{vmatrix}. \quad (3.7)$$

Here, the matrix elements are given by Eq. (3.1) (where $E_{v,l} \equiv E^0$) and Eq. (3.6). $J = 0$ is not allowed and for $J < 3$ only the central two-by-two matrix is allowed. Higher order terms coupling l and $l \pm 4$ levels are sometimes important but were not necessary for the present calculations.

In general the l -type resonance calculation requires the use of a matrix of dimension v_2+1 by v_2+1 . Since this is a nonlinear system, a nonlinear least-squares fitting technique was needed to fit the experimental data to determine the best constants, as explained later.

Most other workers have only used Eq. (3.1) to fit the data of OCS and N_2O . That has the effect of absorbing the l -type resonance into the effective B_v , D_v , and H_v values. While such a treatment is quite reasonable, the effective values of the higher order constants are quite different from the ground state values, and the level at which Eq. (3.1) is truncated has an important effect on both interpolation and extrapolation. By treating the l -type resonance explicitly, we bring the effective values for D_v and H_v much closer to the ground state values. This model gives a better approximation to the true Hamiltonian than the model that only uses Eq. (3.1). This improvement in the model used for fitting the data improves the reliability of the least-squares fits and gives more accurate uncertainties for the calculated transition frequencies.

For each value of $|l|$ (except $l = 0$) the states with $v_2 > 0$ are split into e and f components. For OCS and N_2O the $l = 0$ states ($^1\Sigma^+$ states) always have the same symmetry (or parity) as the e states. These e and f components have been assigned in accordance with the convention established by Brown *et al.* [3.3]. That convention leads to the selection rules:

$$\Delta J = 0, e \leftrightarrow f$$

$$\Delta J = \pm 1, e \leftrightarrow e, \text{ and } f \leftrightarrow f$$

for electric dipole transitions. These selection rules are obeyed even when the normal rule, $\Delta l = 0, \pm 1$, is broken because perturbations always connect e to e and f to f .

All of the l -type resonance energy matrices, like Eq. (3.7), may be factored into two submatrices which represent the e levels in one case and the f levels in the other case. We have used the full matrix, as indicated by Eq. (3.7), rather than a factored form, because it is more convenient for obtaining the eigenvectors needed to calculate the intensities of the transitions.

The present analysis ignores the Fermi resonance that couples the levels $(v_1, v_2 + 2, l, v_3 - 1, J)$ and (v_1, v_2, l, v_3, J) of OCS and N_2O . In OCS the unperturbed Fermi resonance levels are far apart, so there is very little change in the resonance across a band. This results in only small changes in the effective values of D_v , H_v , and L_v . Such small changes can be accommodated by Eq. (3.1) without affecting either the accuracy of the least-squares fits or the accuracy of the calculated values. In N_2O the Fermi resonance is expected to be more important but again the effective values of D_v , H_v , and L_v are only slightly changed from the unperturbed values.

Since the Fermi resonance coupling is different for different values of $|l|$, it gives rise to different effective values of the constants q_v , B_v , etc. for levels that differ only in the value of $|l|$. Consequently, in Eq. (3.7) one must use two values for B_v , one for the $|l|=1$ states and one for the $|l|=3$ states. Similarly, two values are needed for D_v , H_v , and L_v . There will also be two different off-diagonal coupling constants, q_v , in Eq. (3.7), one for the $W_{3,1}$, $W_{1,3}$, $W_{-1,-3}$, and $W_{-3,-1}$ terms and a slightly different one for the $W_{1,-1}$ and $W_{-1,1}$ terms. However, these small differences in q_v are difficult to separate from the differences in B_v and D_v . Consequently, we have been forced to use a single value of q_v for a given vibrational state irrespective of differences in the value of the l quantum number.

In analyzing the spectral data to get the rovibrational constants for calculating the most accurate transition frequencies of OCS and N_2O , a large body of data on many different types of transitions was fit. Because of the form of the energy matrix for l -type resonance, it was not possible to use a linear least-squares technique to fit the data. Instead, an iterative nonlinear least-squares fitting procedure was used. In this procedure it was necessary to approximate the derivative of the transition frequency with respect to each constant by applying the technique described by Rowe and Wilson [3.4].

A similar nonlinear least-squares fitting procedure was used for NO but the energy matrix was somewhat different from Eq. (3.7). For a complete description of the energy matrix for NO one should refer to the work of Hinz *et al.* [5.371].

In order to calculate the statistical uncertainties in the calculated wavenumbers given in these tables it was necessary to use the variance-covariance matrix, given by the least-squares analysis, and the derivative of the transition frequency with respect to each constant. The uncertainty, or estimated standard error, given by $\sigma(\nu)$ was then determined by the double summation,

$$\sigma(\nu) = \sum_i \sum_j V_{ij} (\partial\nu/\partial c_i)(\partial\nu/\partial c_j), \quad (3.8)$$

where V_{ij} is a particular element of the variance-covariance matrix and $\partial\nu/\partial c_i$ and $\partial\nu/\partial c_j$ are the derivatives of the transition frequency with respect to the rovibrational constants c_i and c_j respectively.

Data Sources Used for Fitting the Frequency Data and for Calculating the Transition Wavenumbers

OCS

All of the OCS transitions to be used for calibration (shown with an asterisk in the atlas) were calculated by means of constants and a variance-covariance matrix given by a single least-squares fit that included all of the frequency measurements given in the literature. The equations used in this fit were described in the preceding section. In this section we indicate what references provided the data that went into that fit and give a few more details about the fit and the selection of data.

The rotational spectrum of OCS has been extensively studied by microwave and sub-millimeter wave techniques. These measurements use frequency techniques for calibration and have uncertainties on the order of ± 0.05 MHz and in some cases even smaller uncertainties. Such measurements are blessed with small line widths and are made at low pressures which contribute to the accuracy of the

measurements. The three most abundant isotopic species of OCS have no fine structure due to quadrupole effects.

Some microwave measurements [5.43, 5.79] extend to fairly high J values so they are able to give accurate values for B_v and D_v . In addition, the heterodyne measurements made by Vanek *et al.* [5.124] on high- J transitions were used in the analysis. Although there are a great many measurements of rotational transitions for the lower vibrational states, Bogey and Bauer [5.78] and Tanaka *et al.* [5.98] have given measurements of rotational transitions for fairly high vibrational states, up to 4100 cm^{-1} . Some transitions show the splitting due to l -type resonance and for a few vibrational states, 01¹0 [5.32, 5.47], 02²0 [5.54], and 03³0 [5.54], the transitions between split levels have been observed.

Altogether 333 frequency measurements of rotational transitions, taken from the above references as well as from Refs. [5.5, 5.29, 5.30, 5.37, 5.41, 5.48, 5.55, 5.66, 5.119], were included in the least-squares fit that determined the rovibrational constants given in Tables 5 and 6. When possible these measurements were given uncertainties suggested in the original papers. In some cases the uncertainty was estimated by us, based on other work from that time or from that laboratory, or based on the goodness of the fit.

With three exceptions, all of the infrared heterodyne frequency measurements came from a series of papers from the same laboratory at the National Institute of Standards and Technology in Boulder, Colorado [5.73, 5.83, 5.87, 5.94, 5.107, 5.120-5.122, 5.125, 5.129]. The exceptions are the measurements on the 02⁰0-00⁰0 band and accompanying hot bands made in the Harry Diamond Laboratory by Sattler *et al.* [5.88], the measurements in the same frequency region made at the University of Lille by Fayt *et al.* [5.126], and the preliminary measurements from the University of Bonn [5.137a]. From the root-mean-square (rms) deviations of the NIST measurements it was obvious that their assigned uncertainties were too large by approximately a factor of two. This reflected caution in allowing for systematic errors which would not be revealed by the least-squares analysis.

An extensive set of laser-Stark resonance measurements have been made by Fayt and others [5.105, 5.106, 5.111, 5.112] and by Tanaka *et al.* [5.71, 5.97]. This is a type of frequency measurement that should be quite accurate but we have not included those data in this least-squares fit as they would introduce the additional complications of determining dipole-moment functions and assessing the accuracy of the electric field measurements. In the case of measurements using CO laser transitions there is an additional uncertainty in the laser frequency.

In order to determine the most accurate centrifugal distortion constants, some of the better diode laser and FTS measurements were included in the least-squares fits. For the most part the diode laser measurements given in Refs. [5.83, 5.88, 5.94] were calibrated with the heterodyne measurements and probably had systematic errors much smaller than the dispersion shown by the least-squares fit.

Except for the weakest transitions, the FTS measurements were more precise than any of the other infrared measurements. The high precision, however, does not necessarily imply high accuracy. The FTS data used in the analysis for these tables were taken from Refs. [5.75, 5.101, 5.102, 5.120, 5.122, 5.128, 5.132, 5.135, 5.136] or from private communication with the authors of those papers in the cases where the original data were not published.

The FTS measurements were given uncertainties equal to the rms deviations of the fits on a band-by-band basis. In order to keep the FTS measurements from affecting the determination of the vibrational energy levels, they were fitted to the same rotational constants as the other data, but to different band centers. All of the recommended calibration data were based on vibrational energy levels determined only from frequency measurements, not from FTS or ordinary diode-laser measurements.

For the less abundant isotopomers of OCS many of the above papers plus a few additional papers [5.5, 5.52, 5.82, 5.84] give microwave and sub-millimeter wave measurements of rotational transitions. Some of the infrared heterodyne measurements also included transitions for the less abundant isotopomers of OCS [5.73, 5.87, 5.94, 5.120, 5.122, 5.125]. A few transitions of ¹⁶O¹³C³²S

Table 5. Rovibrational constants (in cm^{-1}) used for $^{16}\text{O}^{12}\text{C}^{32}\text{S}$.

Vib. State	ν_0	B_v	$D_v \times 10^8$	$H_v \times 10^{14}$	$L_v \times 10^{17}$
00 ⁰	0.0	0.202 856 740 8(8) ^a	4.340 64(25)	-0.329(30)	
01 ¹ 0	520.422 055(147)	0.203 209 834 8(21)	4.411 48(31)	-0.260(38)	
00 ⁰ 1	858.966 932(48)	0.202 251 831 6(60)	4.433 50(36)	0.045(45)	
02 ² 0	1041.293 318(239)	0.203 559 482 1(89)	4.483 28(93)	-0.135(80)	
02 ⁰ 0	1047.042 048(11)	0.203 480 485(12)	4.419 64(63)	-0.712(73)	
01 ¹ 1	1372.459 242(136)	0.202 657 042(22)	4.542 71(63)	[0.1] ^b	
03 ³ 0	[1562.611 159]	0.203 905 589 7(148)	4.550 22(80)	[-0.3]	
03 ¹ 0	1573.366 413(158)	0.203 762 735 1(132)	4.453 60(113)	-0.801(206)	
00 ⁰ 2	1710.976 247(76)	0.201 635 352(32)	4.533 64(111)	0.396(102)	
02 ² 1	1886.947 787(135)	0.203 048 230 7(117)	4.639 14(113)	[0.1]	
02 ⁰ 1	1892.230 557(91)	0.202 953 496 6(220)	4.554 09(123)	[-0.3]	
10 ⁰ 0	2062.200 841(121)	0.201 641 530 0(477)	4.409 80(260)	4.551(470)	-0.1155(267)
04 ⁴ 0	[2084.378 374]	0.204 248 031 9(608)	4.592 0(296)	[-0.3]	
04 ² 0	2099.524 648(251)	0.204 051 914 6(232)	4.494 89(828)	[-0.6]	
04 ⁰ 0	2104.827 673(87)	0.203 968 086 4(171)	4.306 15(970)	-32.73(814)	
01 ¹ 2	2218.028 446(175)	0.202 091 366 5(527)	4.682 71(123)	[0.6]	
03 ³ 1	[2402.340 630]	0.203 428 111(148)	4.734 93(580)	[0.1]	
03 ¹ 1	2412.122 352(193)	0.203 259 077 6(203)	4.599 03(43)	[-0.3]	
00 ⁰ 3	2555.991 217(126)	0.201 006 219(100)	4.647 60(514)	1.61(70)	
11 ¹ 0	2575.307 586(181)	0.202 015 427(45)	4.473 84(210)	2.86(28)	
05 ⁵ 0	[2606.596 100]	[0.204 589 3]	[4.55]	[-0.3]	
05 ³ 0	2625.607 054(200)	0.204 345 249(246)	4.583 7(402)	[-0.7]	
05 ¹ 0	2635.589 700(206)	0.204 198 969(125)	4.387 40(643)	[-0.9]	
02 ² 2	[2726.564 984]	[0.202 523 2]	[4.804 7]	[0.1]	
02 ⁰ 2	2731.399 122(245)	0.202 414 701(227)	4.707(109)	[-0.3]	
10 ⁰ 1	2918.104 865(255)	0.201 102 979(109)	5.071 51(681)	54.42(147)	-1.988(95)
04 ⁴ 1	[2918.572 190]	[0.203 799 95]	[4.34]	[-0.3]	
04 ² 1	2932.216 820(310)	0.203 569 074(81)	4.668 2(13)	[-0.3]	
04 ⁰ 1	2937.146 843(207)	0.203 436 472(357)	3.943 2(255)	-52.44(634)	1.71(50)
01 ¹ 3	3057.093 032(518)	0.201 510 88(145)	4.824(81)	[2.2]	
12 ² 0	[3088.908 46]	0.202 382 585(146)	4.531 9(48)	[2.2]	
12 ⁰ 0	3095.554 42(9)	0.202 311 240(147)	4.500 9(56)	[2.2]	
03 ³ 2	[3236.415 907]	[0.202 936 096]	[4.776 6]	[-0.2416]	
03 ¹ 2	3245.260 572(251)	0.202 744 75(42)	4.771 0(128)	[-0.2416]	
00 ⁰ 4	3393.969 128(594)	0.200 363 45(173)	4.792(96)	[2.5]	
11 ¹ 1	3424.139 675(235)	0.201 515 951(235)	4.757 4(105)	8.78(125)	
02 ² 3	[3560.106 489]	[0.201 981 318]	[4.983 28]	[2.397]	
02 ⁰ 3	3564.479 808(987)	0.201 863 71(335)	4.989(220)	[2.397]	
13 ³ 0	[3603.006 802]	[0.202 745 521]	[4.41]	[-1.948]	
13 ¹ 0	3615.345 30(20)	0.202 617 950(637)	4.569(66)	6.7(189)	
04 ⁰ 2 ^c	3762.825 61(83)	0.202 601 23(931)	15.06(323)	-5459.(4814)	160.(3450)
10 ⁰ 2 ^d	3768.497 40(22)	0.200 840 86(229)	-14.315(842)	-3551.(1249)	9138.(864)
12 ² 1	3931.301 568(234)	0.201 923 654(440)	4.782 5(153)	[6.00]	
12 ⁰ 1	3937.427 356(330)	0.201 835 302(539)	4.745 3(180)	[6.00]	
11 ¹ 2	4266.325 10(53)	0.201 069 31(120)	6.539 9(551)	[240.0]	

a) The uncertainty in the last digits (twice the estimated standard error) is given in parentheses.

b) The values enclosed in square brackets were fixed during the analysis.

c) Additional terms needed in the analysis were: $M = -1.03(118) \times 10^{-17}$ and $N = 4.26(153) \times 10^{-21}$.

See Ref. [5.132] for discussion of analysis beyond $J=50$.

d) Additional terms needed in the analysis were: $M = -3.21(28) \times 10^{-17}$ and $N = 3.34(33) \times 10^{-21}$.

Table 6. *l*-type resonance constants (in cm⁻¹) for ¹⁶O¹²C³²S.

Vib. State $\nu_1\nu_2\nu_3$	$q_v^0 \times 10^4$	$q_{vj} \times 10^{10}$
0 1 0	2.121 938 68(53) ^a	1.424 13(102) ^b
0 2 0	2.086 287(47)	0.659(35)
0 1 1	2.285 201(291)	3.593(114)
0 3 0	2.064 232(39)	0.252(22)
0 2 1	2.222 23(145)	1.898(64)
0 4 0	2.018 56(408)	-12.49(345)
0 1 2	2.447 445(564)	6.146(177)
0 3 1	2.183 365(144)	1.475 6(245)
1 1 0	2.155 327(274)	3.764(70)
0 5 0	2.019 577(583)	-1.318(375)
0 2 2	2.365(100)	2.76(137)
0 4 1	2.127 48(95)	-1.168(169)
0 1 3	2.596 1(162)	3.2(120)
1 2 0	2.130 1(102)	6.6(28)
0 3 2	2.302 77(231)	2.93(90)
1 1 1	2.373 76(132)	8.57(31)
0 2 3	[2.42]	[0.6587] ^c
1 3 0	2.100 35(154)	2.06(87)
1 2 1	[2.255 63]	[3.7]
1 1 2	2.709 0(144)	47.6(85)

a) The uncertainty in the last digits (twice the estimated standard error) is given in parentheses.

b) Also included in the fit was a higher order term $q_{vjj} = 0.574(44) \times 10^{-15}$.

c) The values enclosed in square brackets were fixed during the analysis.

and ¹⁶O¹²C³⁴S have enough frequency measurements to warrant being considered as possible calibration transitions. In most cases, however, transitions of the rarer isotopomers are only included in the atlas to help in identifying the other, more useful transitions.

A good many wavelength measurements have been made on the less abundant isotopomers, and they can be found in the bibliography, Chapter V. The most important sources of information on infrared measurements of the less abundant species are Refs. [5.45, 5.65, 5.76, 5.101, 5.109, 5.111, 5.128].

*N*₂O

The microwave data on N₂O are not so extensive as for OCS but a great many measurements are still available. The early work of Pearson *et al.* [5.161] and of Lafferty and Lide [5.156] were very useful as were other early measurements given in the review by Lovas [5.5], namely the data given in Refs. [5.138, 5.139, 5.146, 5.148, 5.159, 5.162]. The ν_1 rotational transitions given by Bogey [5.186] and the high-*J* transitions given by Andreev *et al.* [5.194], by Burenin *et al.* [5.179], and by Vanek *et al.* [5.242] were of particular value for better determining the centrifugal distortion contribution to the line positions.

All of the heterodyne measurements involving N₂O have come from two laboratories, NRC in Canada, and NIST in the U.S. The only saturated absorption measurements were those of Whitford *et al.* [5.183] on the laser transitions, 10⁰0-00⁰1, near 930 cm⁻¹. The other infrared heterodyne measurements were made by Wells and co-workers in a series of papers, Refs. [5.219, 5.221, 5.224, 5.230, 5.231, 5.241, 5.243].

There have been a great many measurements on infrared bands of N₂O using either grating instruments or, more recently, FTS instruments. Some of the more important measurements which were used in the least squares refinement of the constants, but did not contribute to the band centers for the recommended calibration lines, were given in Refs. [5.191-5.193, 5.213, 5.215, 5.220, 5.225, 5.229].

All these data were fit in the same way as was done for OCS. The constants given by the least-squares fit are given in Tables 7 and 8.

For N₂O the Fermi resonance is much more important than for OCS; nevertheless, the Fermi resonance was ignored in the fits and only the *l*-type resonance was included in the analysis. For some levels the Fermi resonance causes an effective centrifugal distortion quite different from that of the ground state.

Table 7. Rovibrational constants (in cm⁻¹) used for ¹⁴N¹⁴N¹⁶O.

Vib. State	ν_0	B_v	$D_v \times 10^7$	$H_v \times 10^{14}$	$L_v \times 10^{17}$
00 ⁰ 0	0.0	0.419 011 006(15) ^a	1.760 91(19)	-1.66(21)	
01 ¹ 0	588.767 741(163)	0.419 573 590(23)	1.788 70(33)	-0.82(46)	
02 ⁰ 0	1168.132 418(198)	0.419 919 855(52)	1.871 21(85)	-8.18(368)	
02 ² 0	1177.744 555(85)	0.420 124 817(41)	1.816 72(78)	5.25(504)	-2.14(69)
00 ⁰ 1	1284.903 289(124)	0.417 255 066(20)	1.725 67(24)	11.30(42)	0.444(27)
03 ¹ 0	1749.064 972(166)	0.420 331 191(67)	1.911 42(80)	-11.89(205)	
03 ³ 0	1766.911 896(161)	0.420 664 523(346)	1.852 1(64)	17.4(405)	
01 ¹ 1	1880.265 695(150)	0.417 918 446(50)	1.733 61(53)	14.15(126)	0.288(102)
10 ⁰ 0	2223.756 693(124)	0.415 559 512(18)	1.754 67(20)	-1.359(218)	
04 ⁰ 0	2322.572 934(211)	0.420 618 036(216)	1.943 02(155)	-384.4(164)	
04 ² 0	2331.121 460(124)	0.420 768 166(253)	1.990 06(230)	321.2(158)	
04 ⁴ 0	[2356.251 397] ^b	[0.421 193 718]	[1.90]	[0.0]	
02 ⁰ 1	2461.996 447(242)	0.418 147 317(318)	1.892 76(175)	[0.0]	
02 ² 1	2474.798 428(324)	0.418 530 238(655)	1.750 31(257)	[0.0]	
00 ⁰ 2	2563.339 334(169)	0.415 605 588(268)	1.639 20(152)	64.40(224)	
11 ¹ 0	2798.292 466(200)	0.416 159 111(81)	1.782 02(46)	-0.47(58)	
03 ¹ 1	3046.212 560(931)	0.418 567 39(164)	1.904 70(539)	[0.0]	
03 ³ 1	[3068.720 525]	[0.419 107]	[1.818]	[0.0]	
01 ¹ 2	3165.853 959(214)	0.416 382 245(410)	1.632 92(294)	48.70(571)	
13 ¹ 0	3931.248 302(341)	0.416 994 90(118)	1.909 53(549)	[0.0]	
13 ³ 0	3948.285 330(370)	0.417 327 81(195)	1.835 5(123)	[0.0]	

a) The uncertainty in the last digits (twice the estimated standard error) is given in parentheses.

b) The values enclosed in square brackets were fixed during the analysis.

Table 8. *l*-type resonance constants (in cm⁻¹) for ¹⁴N¹⁴N¹⁶O.

Vib. State v ₁ v ₂ v ₃	q _v ⁰ × 10 ⁴	q _{v,j} × 10 ⁹
0 1 0	7.920 055 2(83) ^a	1.002 0(155)
0 2 0	7.607 30(98)	2.766(108) ^b
0 3 0	7.472 506(257)	2.889(49) ^c
0 1 1	9.083 842(493)	-2.877(32) ^d
0 4 0	7.481 95(567)	12.379(424)
0 2 1	8.206 5(118)	1.405(305)
1 1 0	7.771 651(471)	1.199 1(185)
0 3 1	8.086 4(103)	2.292(416)
0 1 2	10.722 70(197)	-10.713(76)
1 3 0	7.326 0(111)	3.062(567)

a) The uncertainty in the last digits (twice the estimated standard error) is given in parentheses.

b) Also included in the fit was a higher order term
 $q_{v,jj} = 0.123(315) \times 10^{-13}$.

c) Also included in the fit was a higher order term
 $q_{v,jj} = -0.224(102) \times 10^{-13}$.

d) Also included in the fit was a higher order term
 $q_{v,jj} = 1.109(32) \times 10^{-13}$.

In order to show the position of some of the hot band lines in the spectra, it was necessary to use constants for some levels not included in Tables 7 and 8. The wavenumbers for those lines were calculated by taking the constants for the upper state reported in Refs. [5.191, 5.213, 5.215, 5.229].

For the less abundant isotopic species, the microwave data given in Refs. [5.194, 5.227] were used in preparing these tables. One paper has reported heterodyne frequency measurements in the infrared for ¹⁵N¹⁴N¹⁶O and ¹⁴N¹⁵N¹⁶O [5.231]. For the most part the data for the rarer isotopic species were taken from Refs. [1.7, 5.173, 5.184, 5.192, 5.193, 5.213, 5.215, 5.225, 5.229].

CS₂

Since carbon disulfide (CS₂) is a symmetric linear molecule, it is nonpolar and has no microwave spectrum. There are, however, several high resolution infrared studies of its spectrum in the 1450 to 1550 cm⁻¹ region [5.383, 5.386, 5.389] in addition to the heterodyne measurements made by Wells *et al.* [5.390]. A number of other measurements have been made on CS₂ so that the ground state constants, *B*₀ and *D*₀, are quite well determined for both the ¹²C³²S₂ and ¹³C³²S₂ isotopic species.

The analysis of the ν₃ band of CS₂ is uncomplicated by either Fermi resonance or *l*-type resonance. The analysis used Eqs. (3.1)-(3.3) as described in detail by Wells *et al.* [5.390]. The recommended calibration frequencies are based on the constants given in their paper. Only the 00⁰1-00⁰0 transitions of ¹²C³²S₂ and ¹³C³²S₂ should be used for calibration. The other line wavenumbers given in the tables are for identification purposes and to show how close some weaker lines may be to the calibration lines. The wavenumbers of the other lines were calculated from the constants given by Winther *et al.* [5.389] and may be in error by as much as 0.01 cm⁻¹. In the spectral maps some lines may not be shown in the region below 1505 cm⁻¹ because they arise from transitions not included in the data base.

CO

The carbon monoxide (CO) wavenumbers for the calibration lines given in the atlas were calculated from the constants given in Table 9 and based on Eqs. (3.2) and (3.3). Only the wavenumbers given for the $^{12}\text{C}^{16}\text{O}$ molecule were determined adequately by frequency measurements and so they are the only wavenumbers that should be used for frequency (wavenumber) calibration. There are a few frequency measurements for the other isotopomers, but not enough to provide good calibration.

For the $^{12}\text{C}^{16}\text{O}$ molecule the ground state constants are primarily based on the sub-millimeter wave measurements given by Gordy and Cowan [5.250], Rosenblum *et al.* [5.253], and Helminger *et al.* [5.266] and on the far-infrared heterodyne measurements of Nolt *et al.* [5.309] and Varberg and Evenson [5.320]. Also included in the fit were microwave measurements of the $J = 1 \leftarrow 0$ transitions in the first two vibrationally excited states as reported by Dixon [5.288]. Aside from these two measurements the upper state constants are based primarily on the heterodyne measurements of the 1-0 band given by Schneider *et al.* [5.314] and by Maki *et al.* [5.316] and the 2-0 band given by Pollock *et al.* [5.304]. Also used was one sub-Doppler measurement of the 1-0 band communicated to us by Urban [5.321].

Other data included in the analysis to determine the best constants were some heterodyne laser measurements given by Schneider *et al.* [5.313] and some FTS measurements from Guelachvili *et al.* [5.289, 5.301, 5.307] and Brown and Toth [5.306]. The FTS measurements were used to help

Table 9. Constants used to calculate the $\nu=1 \leftarrow 0$, $\nu=2 \leftarrow 0$, and $\nu=2 \leftarrow 1$ transition wavenumbers for $^{12}\text{C}^{16}\text{O}$.

constant ^a	Wavenumber ^b (cm^{-1})
Y_{10}	2169.812 615(26) ^c
Y_{20}	-13.287 812 0(87)
Y_{30}	0.010 383 46(980)
$Y_{40} \times 10^4$	0.740 03(1300)
$Y_{50} \times 10^6$	-0.137 37(5913)
Y_{01}	1.931 280 858 2(555)
Y_{11}	-0.017 504 036 7(1302)
$Y_{21} \times 10^6$	0.486 50(4041)
$Y_{31} \times 10^7$	0.333 87(2754)
$Y_{02} \times 10^5$	-0.612 159 11(230)
$Y_{12} \times 10^8$	0.100 669(3765)
$Y_{22} \times 10^9$	-0.177 14(2551)
$Y_{03} \times 10^{11}$	0.589 265(709)
$Y_{13} \times 10^{12}$	-0.145 467(300)
$Y_{04} \times 10^{16}$	-0.360 976(20)
$Y_{14} \times 10^{18}$	-0.684 5(47)
$Y_{05} \times 10^{22}$	-0.471 36(167)

a) Dunham coefficients defined by Eq. (3.2).

b) To convert to frequency units multiply by 29 979.2458 MHz/ cm^{-1} .

c) The uncertainty (twice the estimated standard error) in the last digits is given in parentheses. Excess digits are given to avoid round-off errors.

determine the best centrifugal distortion constants for the $v = 1, 2,$ and 3 states. Only heterodyne frequency measurements were used to determine the vibrational frequencies.

The analysis of the CO data was carried out in the same way as described by Maki *et al.* [5.316] except that new data have been included [5.320, 5.321]. In order to avoid the possibility of problems with the potential function model, the lowest order constants, $Y_{10}, Y_{20}, Y_{01}, Y_{11}, Y_{21}, Y_{02}, Y_{12},$ and Y_{03} were fit to data for only the $v = 0, 1,$ and 2 states. The other constants were constrained to values given by earlier fits which included data for higher vibrational states, as described by Schneider *et al.* [5.314].

The uncertainties given for the calibration wavenumbers are based on the variance-covariance matrix given by the least-squares fit with the higher order constants constrained.

The wavenumbers for the other isotopic species of CO were calculated from constants given by Guelachvili *et al.* [5.301], but corrected to agree with the offset observed in the wavenumbers for the $^{12}\text{C}^{16}\text{O}$ species. The wavenumbers for the rarer isotopic species are given to help in correctly identifying the calibration lines.

NO

The wavenumbers of the line positions used to produce the NO atlas were calculated using the constants given by Hinz *et al.* [5.371] for the $^{14}\text{N}^{16}\text{O}$ species. The constants given by Amiot and Guelachvili [5.355] were used for $^{15}\text{N}^{16}\text{O}$ and those given by Amiot *et al.* [5.350] were used for $^{14}\text{N}^{18}\text{O}$. Those were the only transitions strong enough to show on the spectral plots. The uncertainties given in the tables are only estimates based on the accuracy of other heterodyne measurements and an estimate of the accuracy of the Hamiltonian used to fit the data.

The tables only give the wavenumber values for lines of $^{14}\text{N}^{16}\text{O}$. Because only one paper [5.371] reports infrared frequency measurements for NO, the NO lines are not recommended for calibration in those regions where either OCS or N_2O transitions are available for calibration. For many spectrometers most of the NO transitions are unresolved doublets. At low pressures the doublets will have equal intensities and widths so that no appreciable errors will be incurred by using the average frequency of the doublet. A few of the low- J transitions, especially for the Q -branch lines, will have additional structure due to the interaction of the nuclear electric quadrupole moment of the nitrogen atom with the surrounding charge distribution. Such small splittings will be no larger than a few megahertz and the average line positions given in the tables will not be affected.

Intensity Calculations

This section is intended to show how the transition intensities were calculated and how the intensity was defined. This will enable users to determine the intensity to be expected for conditions other than those used to prepare the atlas. In order to estimate the appearance of the spectrum under conditions of pressure broadening and spectrometer resolution different from that used to produce the atlas figures, it is also necessary to consider the line shapes and the effect of finite slit functions. Such effects are discussed in Chapter IV.

The integrated intensity of an individual line representing a single rovibrational transition is independent of the line shape. For this atlas we take the integrated line intensity, S , to mean

$$S = \int_{-\infty}^{+\infty} k(\nu) d\nu = (1/pl) \int_{-\infty}^{+\infty} \ln(I_0/I)_{\nu} d\nu, \quad (3.9)$$

where $k(\nu)$ is the absorption coefficient at frequency ν , p is the partial pressure of the gas, l is the length of the absorption path, I_0 is the intensity of radiation without absorption from the line in

question, and I is the intensity of radiation after absorption by the line. Note that Eq. (3.9) is only concerned with the absorption due to a particular transition.

The integrated intensities, as given in this atlas, were calculated by using the equation

$$S = \exp(-E''/kT) [1 - \exp(-\nu/0.69504T)] [N_i / Q_v Q_r] \times \nu C |R_{\nu''j''j''}^{\nu'j'j'}|^2 S_v^2 S_r^2, \quad (3.10)$$

where C is a proportionality constant that includes the factors $8\pi^3/3hc$ and other factors, such as the Loschmidt constant ($2.686\ 763 \times 10^{25}$ molecules/m³), required to give S in appropriate units. If S is in units of cm/molecule at STP, C is $4.162\ 38 \times 10^{-19}$ cm²D⁻²/molecule. If S is in units of cm⁻²atm⁻¹ at temperature T , C would be $3054.7262/T$ cm⁻¹D⁻²atm⁻¹. In Eq. (3.10) $|R_{\nu''j''j''}^{\nu'j'j'}|$ is the vibrational transition moment or dipole derivative in debye units (1 debye = $3.335\ 64 \times 10^{-30}$ C m), ν is the transition wavenumber in units of cm⁻¹, T is the temperature in kelvin, N_i is the concentration of the isotopic species under consideration, Q_v and Q_r are the vibrational and rotational partition functions respectively, and S_v and S_r are vibrational and rotational strength factors that should be included in the intensity. Some workers prefer to include S_v in the transition moment but we prefer to express it separately so the transition moment can be seen to be nearly the same for the ground state transitions and the accompanying hot bands. S_r is also called the direction cosine matrix element. The intensities given in these tables were calculated for a temperature of 296 K.

In Eq (3.10) the term $N_i / Q_v Q_r$ compensates for the fact that the pressure used in Eq. (3.9) is the total pressure of the gas being measured, including all isotopic species. That is to say, the pressure does not take into account the isotopic concentration or the number of molecules in different states.

Table 10. Percent isotopic abundances.

¹² C	98.90
¹³ C	1.10
¹⁴ N	99.634
¹⁵ N	0.366
¹⁶ O	99.762
¹⁷ O	0.038
¹⁸ O	0.200
³² S	95.02
³³ S	0.75
³⁴ S	4.21
³⁶ S	0.02

The values of N_i were calculated from the isotopic abundances given in Table 10 and taken from Refs. [3.5, 3.6]. The vibrational partition function was calculated by summing the Boltzmann population of the vibrational energy levels. The vibrational partition functions are given in Table 11.

The rotational partition functions were calculated from the equations given by McDowell [3.7]. A different rotational partition function was calculated for each vibrational energy level and for each isotopomer.

Some workers like to use $S^0 = S/N_i$ for S because S^0 seems to be a more appropriate molecular property. On the other hand, S is more useful for analytical purposes, such as the determination of the amount of CO in the atmosphere. Actually, it is $|R|$ or $|R|^2$, rather than S , that is the true molecular property in Eq. (3.10), and, as suggested by Toth [5.218], all intensity measurements should

Table 11. Vibrational partition function and natural abundance for the various isotopic species found in the calibration atlas.

molecule	$Q_v(296\text{ K})$	N_i	molecule	$Q_v(296\text{ K})$	N_i
$^{16}\text{O}^{12}\text{C}^{32}\text{S}$	1.199	0.937 5	$^{12}\text{C}^{16}\text{O}$	1.000	0.986 6
$^{16}\text{O}^{12}\text{C}^{34}\text{S}$	1.203	0.041 63	$^{13}\text{C}^{16}\text{O}$	1.000	0.010 97
$^{16}\text{O}^{13}\text{C}^{32}\text{S}$	1.216	0.010 50	$^{12}\text{C}^{18}\text{O}$	1.000	0.001 98
$^{16}\text{O}^{12}\text{C}^{33}\text{S}$	1.201	0.007 40	$^{12}\text{C}^{17}\text{O}$	1.000	0.000 38
$^{18}\text{O}^{12}\text{C}^{32}\text{S}$	1.207	0.001 92	$^{13}\text{C}^{18}\text{O}$	1.000	0.000 022
$^{14}\text{N}^{14}\text{N}^{16}\text{O}$	1.1273	0.990 3	$^{13}\text{C}^{17}\text{O}$	1.000	0.000 004
$^{14}\text{N}^{15}\text{N}^{16}\text{O}$	1.1364	0.003 64	$^{12}\text{C}^{32}\text{S}_2$	1.424	0.892 95
$^{15}\text{N}^{14}\text{N}^{16}\text{O}$	1.1298	0.003 64	$^{13}\text{C}^{32}\text{S}_2$	1.452	0.009 93
$^{14}\text{N}^{14}\text{N}^{18}\text{O}$	1.1308	0.001 99	$^{12}\text{C}^{34}\text{S}^{32}\text{S}$	1.430	0.079 13
$^{14}\text{N}^{16}\text{O}$	1.000	0.994 0	$^{12}\text{C}^{33}\text{S}^{32}\text{S}$	1.428	0.014 10
$^{15}\text{N}^{16}\text{O}$	1.000	0.003 7			
$^{14}\text{N}^{18}\text{O}$	1.000	0.002 0			
$^{14}\text{N}^{17}\text{O}$	1.000	0.000 38			

report the value of $|R|$, or $|R|^2$. Unfortunately, some authors have left out the N_i term and report values of $|R|$ that are not true molecular properties relatable to the electron distribution in the molecule.

In the infancy of infrared spectroscopy the instrumentation was unable to resolve individual rovibrational transitions, so many early papers measured the intensity of entire vibrational bands. Those papers measured band intensities by using a modification of Eq. (3.9) in which the integration was over the entire band rather than over a single line. The fine points of isotopic concentration and vibrational hot bands were ignored. Even today integrated band intensities are often measured for heavier molecules for which the density of lines is very high.

From those early measurements the term *band intensity* came to mean the intensity of all the lines in a band including all isotopes present in a normal sample and all hot bands. As a first approximation such a band intensity can be calculated from Eq. (3.10) if the terms S_v^2 , S_R^2 , and $N_i/Q_v Q_R$ are all omitted and ν is set equal to the center of the band. This band intensity will generally be within a few percent of the intensity obtained by adding all the line intensities for the band. To be faithful to the original meaning, the true band intensity should be the sum of the intensities of all the lines in the band, including all isotopes and all hot bands.

Calculation of the strength factors

The vibrational strength factors were slightly different for even and odd values of Δv_2 . For simplicity the strength factor was broken into two factors such that

$$S_v^2 = S_{13}^2 S_2^2 \quad (3.11)$$

with

$$S_{13}^2 = (v_1 + \Delta v_1)! (v_3 + \Delta v_3)! / (v_1! v_3! \Delta v_1! \Delta v_3!) \quad (3.12)$$

and for Δv_2 even (or zero)

$$S_2^2 = [1/2(v_2 + l + \Delta v_2)]! [1/2(v_2 - l + \Delta v_2)]! / \{ [1/2(v_2 + l)]! [1/2(v_2 - l)]! \times \{ [1/2(\Delta v_2)]! \}^2 \}, \quad (3.13)$$

while for Δv_2 odd

$$S_2^2 = [^{1/2}(v_2+l+\Delta v_2-1)]! [^{1/2}(v_2-l+\Delta v_2-1)]! (v_2+l\Delta l+\Delta v_2+1) / \left\{ [^{1/2}(v_2+l)]! [^{1/2}(v_2-l)]! \left\{ [^{1/2}(\Delta v_2-1)]! \right\}^2 (\Delta v_2+1) \right\}. \quad (3.14)$$

In both cases $S_2 = 0$ if $|\Delta l| > 1$. In Eqs. (3.12)-(3.14) the smaller of v' and v'' is used for v , $\Delta v = |v'-v''|$, $l = l''$, and $\Delta l = l' - l''$. For the present calculations, S_2 can be taken as the positive square-root of Eqs. (3.13) and (3.14).

Equation (3.12) was derived from the properties of harmonic oscillator wave functions such as can be found, among other places, in Appendix III of Ref. [3.8]. Equations (3.13) and (3.14) were derived from the properties of the two-dimensional harmonic oscillator wave functions given by Moffitt and Liehr [3.9].

Note that S_v^2 is normalized so that transitions from the ground state always have $S_v^2 = 1$. For certain hot bands, such as $2\nu_1 - \nu_1$, $S_v^2 = 2$, while for the hot band $3\nu_1 - \nu_1$, $S_v^2 = 3$. Other authors sometimes include S_v in the transition moment, $|R|$, in which case the transition moment for certain hot bands will be very different from the transition moment for the ground state transitions.

For transitions for which $v_2 = 0$ (and $l = 0$) the rotational strength factors are given by

$$S_R^2 = |m| \text{ for } \Delta J = \pm 1$$

and

$$S_R^2 = 0 \text{ for } \Delta J = 0,$$

where m has the usual meaning of $-J''$ for $\Delta J = -1$ and $J''+1$ for $\Delta J = +1$.

If $v_2 \neq 0$, the l -type resonance energy matrix was used and the intensity was obtained by multiplying each term of the eigenvector, for the appropriate eigenvalue, by the appropriate intensity factor given by $S_v S_R$ where S_R was determined from Table 2.1 of Gordy and Cook [3.11], or Table 4-4 of Townes and Schawlow [3.12]. Di Lauro and Mills [3.13] describe a similar procedure for determining intensities of transitions in Coriolis coupled levels of a symmetric rotor. For the specific cases of l -type resonance, this procedure was described by Maki *et al.* [3.14] although they dealt with the symmetry factored matrix whereas the present calculations used the unfactored matrix, such as Eq. (3.7).

To understand this intensity calculation let us consider a transition from an unperturbed lower state (v_1, v_2, l, v_3, J) to an upper state that is involved in l -type resonance, $(v_1', v_2', l', v_3', J') = (v_1 + \Delta v_1, v_2 + \Delta v_2, l + \Delta l, v_3 + \Delta v_3, J')$. The upper state energy is given by a particular eigenvalue, E_1 . The eigenvector for this eigenvalue gives the mixing coefficients a_{11} , a_{12} , a_{13} , *etc.* that measure the contribution of each unperturbed state to the perturbed state. The transition intensity is given by

$$\begin{aligned} & | \langle v_1 + \Delta v_1, v_2 + \Delta v_2, l + \Delta l, v_3 + \Delta v_3, J + \Delta J | \mu | v_1, v_2, l, v_3, J \rangle |^2 = \\ & | a_{11} \langle v_1 + \Delta v_1, v_2 + \Delta v_2, l' = v_2 + \Delta v_2, v_3 + \Delta v_3, J + \Delta J | \mu | v_1, v_2, l, v_3, J \rangle \\ & + a_{12} \langle v_1 + \Delta v_1, v_2 + \Delta v_2, l' = v_2 + \Delta v_2 - 2, v_3 + \Delta v_3, J + \Delta J | \mu | v_1, v_2, l, v_3, J \rangle \\ & + a_{13} \langle v_1 + \Delta v_1, v_2 + \Delta v_2, l' = v_2 + \Delta v_2 - 4, v_3 + \Delta v_3, J + \Delta J | \mu | v_1, v_2, l, v_3, J \rangle \\ & \dots |^2. \end{aligned} \quad (3.15)$$

All the upper state quantum numbers on the left side of Eq. (3.15) are the same as those on the right side except the l' values. The l -type resonance mixes levels that differ only in the value of l .

If one assumes that the transition moment, or dipole derivative, is the same for all values of l , then Eq. (3.15) can be rewritten

$$\begin{aligned}
|\mathbf{R}|^2 S_{\nu}^2 S_{\mathbf{R}}^2 = & |\mathbf{R}|^2 S_{13}^2 \{ a_{11} S_2 S_{\mathbf{R}}(v_2 + \Delta v_2, l = v_2 + \Delta v_2, J' \leftarrow v_2, l'', J'') \\
& + a_{12} S_2 S_{\mathbf{R}}(v_2 + \Delta v_2, l = v_2 + \Delta v_2 - 2, J' \leftarrow v_2, l'', J'') \\
& + a_{13} \dots \}^2.
\end{aligned} \tag{3.16}$$

Each term within the curly brackets on the right side of Eq. (3.16) has a different value for S_2 and $S_{\mathbf{R}}$ depending on the unperturbed transition to which they apply. In many cases they will be zero because they apply to $|\Delta l| > 1$. In Eqs. (3.12)-(3.14) we have already given the formulas for the values of S_{13}^2 and S_2^2 .

The only nonzero values of $S_{\mathbf{R}}$ are given below.

For $\Delta l = 0$, the $\Delta J = 0$ transitions have

$$S_{\mathbf{R}} = [(2J+1)l^2/J(J+1)]^{1/2} \tag{3.17}$$

and the $\Delta J = \pm 1$ transitions have

$$S_{\mathbf{R}} = [(|m|^2 - l^2)/|m|]^{1/2}. \tag{3.18}$$

For $\Delta l = \pm 1$, the expressions for $\Delta J = 0$ were

$$S_{\mathbf{R}} = 1/2[(2J+1)(J+l)(J-l+1)/J(J+1)]^{1/2}, \tag{3.19}$$

where l is the larger of l' and l'' . For $\Delta l = +1$ and $\Delta J = +1$,

$$S_{\mathbf{R}} = -1/2[(J+l)(J+l+1)/J]^{1/2}; \tag{3.20}$$

for $\Delta l = +1$ and $\Delta J = -1$,

$$S_{\mathbf{R}} = 1/2[(-J+l)(-J+l+1)/J]^{1/2}; \tag{3.21}$$

for $\Delta l = -1$ and $\Delta J = +1$,

$$S_{\mathbf{R}} = 1/2[(J-l)(J-l+1)/J]^{1/2}; \tag{3.22}$$

and for $\Delta l = -1$ and $\Delta J = -1$,

$$S_{\mathbf{R}} = -1/2[(-J-l)(-J-l+1)/J]^{1/2}. \tag{3.23}$$

In Eqs. (3.19)-(3.23) J is the larger of J' and J'' but l is always l'' .

When both the upper and lower states are involved in l -type resonance, Eqs. (3.15) and (3.16) must be modified to include the eigenvectors for both the upper and lower states, otherwise the treatment is the same.

Herman-Wallis terms

Sometimes it is necessary to divide $|R_{v''j''}^{v'j'}|$ into two terms such that

$$|R_{v''j''}^{v'j'}|^2 = |R_{v''j''}^{v'j'}|^2 F_{j''}^{j'}, \quad (3.24)$$

where $F_{j''}^{j'}$ is similar to the Herman-Wallis term [3.15, 3.16]. There are several forms that have been used for the $F_{j''}^{j'}$ term. For the overtone of CO the form used was

$$F_{j''}^{j'} = 1 + C_1 m + C_2 m^2. \quad (3.25)$$

Toth [5.218], in his extensive intensity measurements for N₂O, has given the values for the Herman-Wallis constants for several bands. Toth has used several formulations such as Eq. (3.25) above and also

$$F_{j''}^{j'} = [1 + aJ(J+1) + bJ^2(J+1)^2] \quad (3.26)$$

$$F_{j''}^{j'} = [1 + a_1 m + a_2 J'(J'+1)]^2 \quad (3.27)$$

$$F_{j''}^{j'} = [1 + \xi_1 m + \xi_2 m^2]^2. \quad (3.28)$$

In the case of OCS, Dang-Nhu and Guelachvili [5.104] used the form of Eq. (3.25) for the 11⁰-00⁰ band. The same constant was also used to calculate the intensities of the hot bands for which $\Delta v_1 = 1$ and $\Delta v_2 = 1$. The same form and, coincidentally, almost the same value for the Herman-Wallis term was used for the ν_2 band system. As recommended by Maki *et al.* [5.132], we used

$$F_{j''}^{j'} = [1 + a_3 J'(J'+1)] \quad (3.29)$$

for the hot bands 10⁰-00⁰1 and 04⁰-00⁰1 in order to allow for the resonance interaction of the upper states. For the other transitions, there seemed to be no need for using a Herman-Wallis term in the intensity calculations.

For the 03¹-01¹0 band of OCS, Depannemaecker and Lemaire [5.118] found that the first term, C_1 , in Eq. (3.25) was needed although no Herman-Wallis term was needed for the 02⁰-00⁰ band. On the other hand, the more extensive measurements of Blanquet *et al.* [5.134] showed that a Herman-Wallis term would improve the intensity fit for 02⁰-00⁰.

Data Sources for Intensity Calculations

OCS

Only a small number of intensity measurements have been published for OCS. Most of them are measurements of integrated band intensities including transitions from the ground state as well as from other low energy states populated at room temperature, hot bands. The most thorough studies of band intensities are those of Foord and Whiffen [5.49] and Kagann [5.89] where references to earlier work may be found. Kagann's values were consistently smaller by 11 to 15 percent except for the strongest band near 2062 cm⁻¹ for which Kagann found an intensity that was 18 percent *larger*.

There have been only 9 papers reporting intensity measurements of individual rovibrational transitions [5.73, 5.74, 5.83, 5.85, 5.103, 5.104, 5.118, 5.127, 5.134] and the first three of those papers are considerably less thorough than the others. In addition, there are two papers that give information on the relative intensities of well resolved rovibrational transitions without making absolute intensity measurements [5.101, 5.132].

Table 12 Integrated intensities and transition moments for OCS.

Band	Frequency Interval (cm ⁻¹)	Measured Integrated Intensity (cm ⁻² atm ⁻¹) ^c at 296 K	[REF.]	Used in Atlas Calculation		Transition Moment ^a $ R_{v''v'}^{y'z'} ^b$ (debye) ^d
				Integrated Intensity (cm ⁻² atm ⁻¹) at 296 K	(cm/molecule) $\times 10^{19}$	
ν_2	494-567	11.9(8) ^e 12.0(8)	[5.28] [5.89]	11.85	4.78	0.047
ν_3	812-890	41.(4) 35.4(16) 35.5(23) 36.3(10) 36.3(1)	[5.49] [5.85] [5.89] [5.103] [5.127]	36.3	14.64	0.064
$2\nu_2$	1000-1095	14.9(15) 13.3(9) 12.9 ^f 12.7 ^f	[5.49] [5.89] [5.118] [5.134]	13.8 ^f	5.57	0.0333
$2\nu_3$	1650-1739	7.6(16) 6.71(47)	[5.49] [5.89]	6.9	2.78	0.0195
$2\nu_2 + \nu_3$	1832-1934	12.4(25) 10.9(8)	[5.49] [5.89]	11.2	4.52	0.022
ν_1	1970-2091	2520.(250) 2980.(220)	[5.49] [5.89]	2533.	1021.7	0.345
$4\nu_2$	2080-2141	19.5(49) 9.6 ^f	[5.49] [5.101]	10.4 ^f	4.19	0.024
$3\nu_3$	2510-2574		[5.132]	0.35	0.14	0.00367
$\nu_1 + \nu_2$	2550-2600	0.147(6) ^f	[5.104]	0.149 ^f	0.060	0.00257
$2\nu_2 + 2\nu_3$	2693-2763	0.52(8)	[5.49]	0.52	0.21	0.004
$\nu_1 + \nu_3$	2862-2941	37.6(40) 33.6(22)	[5.49] [5.89]	35.5	14.3	0.034
$4\nu_2 + \nu_3$	2910-2970	0.32 ^f	[5.132]	0.32 ^f	0.13	0.0036
$\nu_1 + 2\nu_2$	3065-3120	3.01(30) 2.25(16)	[5.49] [5.89]	2.43	0.98	0.008

- a) See the key page for each band region for transition moments of hot bands that are not the same as for the ground state transitions.
b) See Eq. (3.24) for definition of $|R_{v''v'}^{y'z'}|^b$.
c) $1 \text{ cm}^2\text{atm}^{-1} \text{ at } 296 \text{ K} = 4.0335 \times 10^{-20} \text{ cm/molecule}$
d) $1 \text{ debye} = 3.336 \times 10^{-30} \text{ C m}$.
e) The uncertainties in the last digits are given in parentheses.
f) Hot band intensities were not included.

Several papers [5.49, 5.97, 5.100, 5.106, 5.112] have used intensity and/or dipole moment measurements to derive a dipole moment function for OCS. At the present time the dipole function of OCS can be used to predict the dipole moment of OCS in different vibrational states, but it is not very useful for predicting transition intensities. The accuracy of the dipole moment function for predicting dipole moments is due largely to the fact that it is based on very accurate laser-Stark measurements involving many vibrational states.

Table 12 summarizes the intensity measurements reported in the literature. Table 12 also gives the transition moments used in the calculations for this atlas and the integrated intensity of each

band as obtained by actually summing all of the transitions within each band, including all hot bands and all isotopic species. In a few cases, where indicated by a footnote, the integrated intensity given in the literature and reported in Table 12 does not include the hot band intensity. In those cases Table 12 gives the intensity calculated without including the contribution from hot bands in order to more easily compare the intensity used in this atlas with what was reported in the literature.

Only a few bands of OCS show any need for Herman-Wallis terms. As is usually the case, the two perpendicular bands, ν_2 and $\nu_1 + \nu_2$, required a small Herman-Wallis term, $C_1 = 0.0045$ and 0.00463 for the two bands, respectively. The Herman-Wallis term is defined by Eqs. (3.24) and (3.25). For ν_2 it was estimated by us from inspection of the experimental spectrum and is not a very accurate value. The H.-W. term for $\nu_1 + \nu_2$ was measured by Dang-Nhu and Guelachvili [5.104]. Although the Herman-Wallis term is likely to be somewhat different for different isotopes and for hot bands, the same term was used for all bands involving the same quantum number changes unless indicated in the key that accompanies the tables.

The only other bands that were given nonzero Herman-Wallis constants were some of the hot bands that go with $2\nu_2$ and the hot bands 04^02-00^01 and 10^02-00^01 which involve resonance coupled upper states. Depannemaecker and Lemaire [5.118] determined that $C_1 = 0.0019$ gives the best fit to their intensity data for 03^10-01^10 transitions. We have used the same H.-W. term for most of the other hot bands accompanying $2\nu_2$; see the descriptive key accompanying the 1000 cm^{-1} to 1095 cm^{-1} tables. Maki *et al.* [5.132] have given effective constants $a_3 = 0.00105$ and $a_3 = -0.00034$, respectively, to the resonance coupled transitions. The latter constants are based on Eqs. (3.24) and (3.29).

After the tables were prepared the new intensity measurements of Blanquet *et al.* [5.134] became available and it leads us to believe that the intensity values in the tables are too high by about 7 percent because we assumed that the dipole derivative given by Depannemaecker and Lemaire took into account the isotopic abundance. Any revised intensity calculations for the $2\nu_2$ band should also include the Herman-Wallis constant measured by Blanquet *et al.* [5.134].

N_2O

A great many intensity measurements have been made on the various bands of N_2O given in this atlas. Not all the measurements are given in Table 13, but the most important or most recent measurements are given there.

As was the case for OCS, the earlier measurements were of the intensity of the unresolved bands. Such measurements included all hot bands and all isotopic species present in a normal sample. One of the more complete sets of measurements is that reported by Kagann [5.214]. Many earlier measurements are summarized in that paper. Kobayashi and Suzuki [5.228] have fit the available data on intensities to a dipole moment function from which they calculate transition moments and Herman-Wallis constants. More measurements are needed to evaluate the accuracy of the constants calculated from their dipole moment function.

Because of the interest in N_2O as an atmospheric gas, the more recent intensity measurements involve spectra with resolved rotational structure and individual rovibrational lines have been measured. In many places in Table 13 we give both the intensity of the transitions from the ground state and the intensity of all transitions with the same change of quantum numbers regardless of the lower state. That allows one to compare our intensities with those reported in the literature.

For most of the transitions we have tried to use what we judge to be the best measurements for the intensity but in a few cases we have departed from the literature values in order to give a more realistic appearance to the spectrum. For example, we have used the transition moment given by Toth [5.218] for the ν_3 band near 1270 cm^{-1} , but the transition moment given for the $2\nu_2$ band did not give a calculated spectrum that matched the observed spectrum where the two bands overlap. This mismatch caused us to use a slightly smaller value for the transition moment for $2\nu_2$ than that given by Toth. It is possible that either the Herman-Wallis constants or the intensity of the ν_3 band should

Table 13 Integrated intensities and transition moments for N₂O.

Band	Frequency Interval (cm ⁻¹)	Measured Integrated Intensity (cm ⁻² atm ⁻¹) ^c at 296 K	[REF.]	Used in Atlas Calculation		Transition Moment ^a $ R_{v''v'}^{x''} ^b$ (debye) ^d
				Integrated Intensity (cm ⁻² atm ⁻¹)	(cm/molecule) × 10 ¹⁹ at 296 K	
ν_2	520-660	28.9(15) ^{ef}	[5.214]	24.5	9.88	0.0692
		30.4(40) ^f	[5.151]	29.2 ^f		
		31.4(40) ^f	[5.157]			
$\nu_1-\nu_3$	880-990	0.0524	[5.209]	0.052	0.021	0.056
		0.055	[5.172]			
$\nu_1-2\nu_2$	990-1090	---	---	0.01	0.004	0.018
$2\nu_2$	1110-1225	7.00(3)	[5.218]	6.66	2.69	0.0247
		7.36(7)	[5.216]	8.30 ^f		
		6.98	[5.237]			
		8.27(43) ^f	[5.214]			
		8.49(9) ^f	[5.234]			
ν_3	1200-1340	207.(1)	[5.218]	206.	83.1	0.1326
		225.(12) ^f	[5.214]	232.5 ^f		
		226.(2) ^f	[5.234]			
		229.8(45)	[5.216]			
$\nu_2+\nu_3$	1835-1925	0.52(3)	[5.212]	0.52	0.21	0.00548
		0.58(10) ^f	[5.214]	0.60 ^f		
		0.437(20)	[5.185]			
ν_1	2140-2269	1207.(22)	[5.226]	1206.	486.4	0.244
		1421.(76) ^f	[5.214]	1358. ^f		
		1189.(30)	[5.187]			
		1302.(50)	[5.171]			
		1301.(54) ^f	[5.198]			
$2\nu_2+\nu_3$	2410-2510	6.79(4)	[5.216]	6.7	2.7	0.017
		7.35(38) ^f	[5.214]	8.2 ^f		
$2\nu_3$	2490-2605	30.86(14)	[5.216]	32.1	12.9	0.037
		32.1(17) ^f	[5.214]	36.3 ^f		
$\nu_1+\nu_2$	2725-2840	2.24(13) ^f	[5.214]	1.895	0.764	0.0086
		2.11	[5.235]	2.26 ^f		

- a) Unless indicated otherwise (see footnote f), the integrated intensities are given only for the vibrational transition from the ground state.
b) See Eq. (3.24) for definition of $|R_{v''v'}^{x''}|$.
c) 1 cm⁻²atm⁻¹ at 296 K = 4.0335 × 10⁻²⁰ cm/molecule.
d) 1 debye = 3.336 × 10⁻³⁰ C m.
e) The uncertainties in the last digits are given in parentheses.
f) All hot bands and isotopes are included.

have been changed. The more reasonable thing seemed to be to change the intensity of the weaker band. We have also recognized that Toth has included the vibrational factors in the dipole moment matrix elements that he reported, whereas Eq. (3.10) treats that as a separate term that multiplies the transition moment.

The two bands $2\nu_2 + \nu_3$ and $2\nu_3$ also overlap and again there was some modification of the literature values for the intensities in order to get a good agreement between the calculated spectrum and that obtained experimentally.

We know of no intensity measurements for the $\nu_1 - 2\nu_2$ transitions between 990 and 1090 cm^{-1} ; consequently, we have estimated the intensity for that region. The true intensity could be quite different from what we have estimated, but the relative intensities of the lines in that region are probably good enough to recognize and assign the lines needed for calibration. That band is so weak that it is probably useless as a source of calibration for many workers, but it was included because it is based on frequency measurements. Since the lower energy level of the band is quite high, heating the absorption cell will make a large difference in the intensity.

Please see Eqs. (3.24) to (3.29) for the definition of the various Herman-Wallis constants used in this work. In his intensity studies [5.218, 5.185] Toth has given Herman-Wallis terms for all the bands. For the most part we have used those constants in the intensity calculations for the tables and figures. Several exceptions were made, however. For the $03^0 0 - 01^0 0$ hot band we have used the same Herman-Wallis terms as given by Toth for the $02^0 0 - 00^0 0$ band. For the other transitions involving $\Delta v_2 = 2$, we have estimated the intensity constants to be used for the calculations because they were not included in Toth's tables.

There seems to be no determination of a Herman-Wallis constant for the $\Delta v_2 = 1$ transitions, therefore, we used $a_1 = 0.0016$ which was estimated from the experimental spectrum. This value was estimated from laboratory spectra that were compared with the calculated spectrum. The intensities of the lines in the bands in the 1835-1925 cm^{-1} region were all calculated with $\xi_1 = -0.0107$ as measured by Toth and Farmer [5.185]. The two Herman-Wallis constants measured by Boissy *et al.* [5.187] for the ν_1 band, were used for all the $\Delta v_1 = 1$ transitions including hot bands and different isotopomers used in the tables. The $2\nu_2 + \nu_3$ band also seemed to require a Herman-Wallis term although the spectra were better matched with a value of $\xi_2 = 0.3 \times 10^{-4}$ rather than the term given by Levy *et al.* [5.216]. No Herman-Wallis terms were used in the intensity calculations for the $\nu_1 - \nu_3$, $\nu_1 - 2\nu_2$, $2\nu_3$, and $\nu_1 + \nu_2$ bands and the hot bands that accompany them.

CS₂

Only a few intensity measurements have been made on the ν_3 band of CS₂ [5.375, 5.377, 5.378, 5.379]. There seem to be no measurements of individually resolved rovibrational transitions, only integrated band intensities. For the purposes of this atlas we have calculated all hot band and isotopomer transitions with the same transition moment, 0.27 debye, and with no Herman-Wallis terms. The integrated intensity for the 1500 cm^{-1} band region of CS₂ is 9.309×10^{-17} $\text{cm}/\text{molecule}$ (2308 $\text{cm}^2\text{atm}^{-1}$ at 296 K) as determined from adding all the line intensities including hot bands and different isotopes. This may be compared to the value 9.55×10^{-17} $\text{cm}/\text{molecule}$ given by McKean *et al.* [5.378], 9.38×10^{-17} $\text{cm}/\text{molecule}$ given by Robinson [5.375], 9.23×10^{-17} $\text{cm}/\text{molecule}$ given by Kiyama and Ozawa [5.377], and 9.13×10^{-17} $\text{cm}/\text{molecule}$ given by Person and Hall [5.379].

CO

fundamental band

Because of the large spacing between lines, CO was one of the first molecules for which individual line intensities were measured [5.255]. More recent measurements are tabulated in the review article by Smith *et al.* [5.2]. For the fundamental band near 2143 cm^{-1} it is difficult to determine which measurements are best but most of the recent measurements give integrated band intensities close to 1.027×10^{-17} $\text{cm}/\text{molecule}$ (276 $\text{cm}^2\text{atm}^{-1}$ at 273.15 K). For this atlas we have used a dipole transition moment of 0.1073 D which gives a total band intensity of 1.03×10^{-17} $\text{cm}/\text{molecule}$ (276 $\text{cm}^2\text{atm}^{-1}$ at 273.15 K or 255 $\text{cm}^2\text{atm}^{-1}$ at 296 K). The changes in the matrix elements for the less abundant isotopic species were taken from the theoretical calculations of Chackerian and Tipping

[5.305]. The isotopic abundance was taken from Table 11. The uncertainty in the total band intensity seems to be about 3 percent. The intensity measurements of Chackerian *et al.* [5.300] (1.027×10^{-17} cm/molecule) are in agreement with other recent measurements for the main isotopic species and they also have studied the intensity of the weaker isotopic transitions. They gave transition intensities calculated from the electric dipole moment function given by Chackerian and Tipping [5.305]. Their calculated intensities seem to include a weak Herman-Wallis effect but they do not give any explicit constants for easily calculating that effect. A calculation that duplicates their temperature and dipole derivative agrees with their values to within one percent (for $J < 35$) even without including a Herman-Wallis effect.

In an earlier paper [5.282] Tipping gave calculated values for the Herman-Wallis constants but they were small enough to ignore for this atlas. Bouanich [5.310] has also given calculated values for the Herman-Wallis constants. Apparently there are only two experimental determinations of Herman-Wallis constants that have been reported for the fundamental band of CO [5.261, 5.318]. The earlier work is subject to question because of the sensitivity to temperature errors. The most recent measurement was reported after this work was done and would change the intensities by no more than one percent. The intensity calculations used for the atlas did not include a Herman-Wallis effect for the fundamental band.

first overtone

Fewer intensity measurements have been made on individual lines of the overtone band near 4260 cm^{-1} . A good average of the more recent values seems to give an integrated band intensity of 7.78×10^{-20} cm/molecule ($2.09 \text{ cm}^2 \text{ atm}^{-1}$ at 273.15 K) with an uncertainty of about six percent. This is equivalent to a transition dipole matrix element of 0.0066 D.

The Herman-Wallis effect is significant for the first overtone band and has been included in the intensity calculation for the atlas. The constants given by Tipping [5.282], $C_1 = 0.005$ and $C_2 = 0.000\ 034$ [see Eq. (3.25)], were used for the calculation of the intensities of the first overtone transitions. Those calculated Herman-Wallis constants were in agreement with three experimental determinations [5.265, 5.271, 5.295] as well as with the calculation of Toth *et al.* [5.265].

NO

A transition moment of 0.00412 debye was used to calculate the line intensities given in the tables. This gives an integrated band intensity of about 5.04×10^{-18} cm/molecule ($125 \text{ cm}^2 \text{ atm}^{-1}$ at 296 K) which agrees with the measurements of King and Crawford [5.330], Mandin *et al.* [5.359], and Holland *et al.* [5.368]. Some earlier measurements [5.326, 5.344, 5.347, 5.364, 5.367] and even some recent measurements [5.374] indicate that the intensity might be more like 4.44 to 4.64×10^{-18} cm/molecule (110 to $115 \text{ cm}^2 \text{ atm}^{-1}$ at 296 K) so the intensities given in the tables may be too large by about ten percent. We have taken the higher intensity value because NO is prone to having impurities that are hard to remove, thus giving low intensity readings.

Other Line Parameters

Lineshape and pressure broadening

Smith *et al.* [5.2] have given a good discussion of lineshapes and the determination of pressure broadening coefficients. We shall give here only a brief description to ensure that the reader understands the principal equations describing these effects. For a more complete understanding of the subject one should refer to the work of Smith *et al.* [5.2] and the papers to which they refer.

For a static gas in a field-free environment at pressures below one atmosphere, there are four major factors that might contribute to the shapes of infrared absorption lines, (1) lifetime broadening, (2) Doppler broadening, (3) pressure broadening, and (4) collisional narrowing.

lifetime broadening

The lifetime broadening of a state n is given by

$$\gamma_n = h/2\pi\tau_n,$$

where γ_n is the half-width of the state and τ_n is the lifetime of that state. For a transition $i \rightarrow j$ between two states, i and j , the transition linewidth will be given by the lifetime of both upper and lower states,

$$\gamma_{i \rightarrow j} = (1/\tau_i + 1/\tau_j)h/2\pi.$$

For most stable molecules in the ground electronic state the radiative lifetime in a given rovibrational state will be on the order of 1 ns or more which gives a linewidth of about $1 \times 10^8 \text{ cm}^{-1}$ (0.16 kHz) or less. This is much smaller than the Doppler width even at temperatures on the order of 5 K. For Doppler-free measurements the effect of lifetime broadening could be important even for stable molecules although various instrumental effects, such as beam width or beam collimation, usually limit the effective linewidth. Transit time broadening is a variation of lifetime broadening where the lifetime is the time that the molecule is in the lightbeam.

Doppler broadening

The Doppler width is the result of the random motion of the molecules in a gas sample and is given by

$$\gamma_D = 3.581 \times 10^{-7} \nu (T/M)^{1/2}, \quad (3.30)$$

where ν is the wavenumber or frequency of the transition, T is the temperature of the gas in kelvin, M is the relative molecular mass of the molecule in atomic mass units, and γ_D is half the width of the transition at half the intensity (half-width at half height or HWHH). Since spectrometer resolution is often expressed in terms of the full width at half the line height (FWHH), the Doppler width is sometimes given by $2\gamma_D$.

For most gases at ambient temperatures and pressures below 2 kPa (15 Torr), the true lineshape (that is, the lineshape that would be observed with an instrument with infinite resolution) is dominated by the Doppler effect. For some molecules the effect of collisional narrowing, see below, is also important in that pressure regime. The Doppler effect gives a Gaussian lineshape which is described by the function

$$f(\nu) = \{[(\ln 2)/\pi]^{1/2}/\gamma_D\} \exp\{-(\ln 2)[(\nu-\nu_0)/\gamma_D]^2\}, \quad (3.31)$$

where ν_0 is the frequency (or wavenumber) of the center of the line.

In Eq. (3.31) the Gaussian shape function $f(\nu)$ has been normalized so that

$$\int_{-\infty}^{+\infty} f(\nu) d\nu = 1. \quad (3.32)$$

Consequently, since

$$k(\nu) = S f(\nu), \quad (3.33)$$

integrating both sides of Eq. (3.33) over all frequency space gives

$$\int_{-\infty}^{+\infty} k(\nu) d\nu = \int_{-\infty}^{+\infty} S f(\nu) d\nu = S. \quad (3.34)$$

Here $k(\nu)$ is the absorption coefficient at frequency ν and S is the integrated line intensity given earlier in Eq. (3.9).

One important characteristic of the Gaussian lineshape is the small wing absorption due to the exponential reduction in absorption as one gets farther from the center of the line. As pointed out by Korb *et al.* [5.263], accurate intensity measurements are more easily made when the wing absorption is small. Another characteristic of the Gaussian shape is the bluntness at the center of the line.

pressure broadening

Pressure broadening gives rise to lines with a Lorentzian lineshape for which the normalized shape function has the form

$$f(\nu) = (\gamma_L/\pi) / [(\nu-\nu_0)^2 + \gamma_L^2], \quad (3.35)$$

where γ_L is half the width of the line at the half intensity point. When pressure broadening is the dominant effect determining the lineshape, then Eq. (3.35) must be used in Eqs. (3.33) and (3.34).

Pressure broadening is an additive effect, therefore, the broadening of each gas in a mixture depends only on the partial pressure, P_x , of that gas. The total broadening in a mixture is the sum of the broadening of each gas. Thus, for gases a and b with broadening coefficients c_a and c_b , the total pressure broadened width will be $\gamma_L = c_a P_a + c_b P_b$. The broadening coefficient is unique to each absorbing molecule and to each collision partner. The broadening coefficient is a function of the temperature as one might expect since the average collision velocity changes with temperature. The broadening coefficient is also different for each rotational transition although the changes are systematic with the rotational quantum numbers.

The pressure broadening coefficients generally have values in the range of 400 to 1300 MHz/Pa (3 to 10 MHz/Torr) and are greatest for molecules that have large dipole moments. The pressure broadening coefficients are generally smallest for those rotational energy levels that are at relatively high energy.

In contrast to Gaussian shaped lines, the Lorentzian shaped lines are sharper at the line center but have very extensive wings. For very strong lines it is possible to have significant absorption intensity twenty half-widths from the line center. This is noticeable in the CO atlas where there is only a small amount of pressure broadening and yet the strong lines have very noticeable wings. If there were no pressure broadening, the wings of the strong lines would not be so prominent.

Voigt profile

In many cases the lineshape is determined both by the Doppler effect and by the effects of pressure broadening. In such cases the lineshape is more accurately given by a Voigt profile which is a convolution of the Gaussian and Lorentzian profiles. There is no good single closed-form expression for the Voigt profile. Rather, the Voigt shape function is given by the integral expression

$$f(\nu) = (Bx/\pi) \int_{-\infty}^{+\infty} [\exp(-y^2)] / [x^2 + (z-y)^2] dy \quad (3.36)$$

and various approximations to that integral. Equation (3.36) has been simplified by using

$$B = (1/\gamma_D)[(\ln 2)/\pi]^{1/2},$$

$$x = (\gamma_L/\gamma_D)(\ln 2)^{1/2},$$

and

$$z = [(\nu - \nu_0)/\gamma_D](\ln 2)^{1/2}.$$

There are a number of good computer programs [3.17, 3.18] for evaluating the Voigt shape function.

collisional narrowing

Collisional narrowing or Dicke narrowing [3.19-3.21] has only recently been measured for a few molecules, but its effects have been observed for NO [5.370]. Collisional narrowing has the effect of reducing the size of the Gaussian linewidth γ_D . In other words, it makes the line appear to have a Doppler width that is smaller than that calculated by Eq. (3.30). For NO, the effective Gaussian width is about 9 percent smaller than the Doppler width at a pressure of 6.6 kPa (50 Torr). Since collisional narrowing is primarily a kinetic collisional effect (sometimes described in terms of hard and soft collision models), it is not expected to depend on the rotational or vibrational levels involved in the transition. There is, however, a weak dependence on the transition assignment as shown by Pine and Looney's work on HCl and HF [3.22].

Estimating peak intensities

From tables of line intensities, such as are given in this atlas, it is possible to estimate the pressure-pathlength product needed to obtain a spectrum with adequate intensity. For this purpose we consider the two limiting cases of Doppler (or Gaussian) shaped lines at low pressures and the pressure broadened Lorentzian lines for high pressures.

If the effect of pressure broadening is negligible and the lineshape is determined by the Doppler width rather than the spectrometer slit function, the percent transmission at the center of a line is given by

$$\% \text{ transmission} = 100 \exp(-CSlp/\gamma), \quad (3.37)$$

where C is 1.1494×10^{14} if S is the intensity given in the tables (in units of cm/molecule), γ is the Doppler width [given by Eq. (3.30)], l is the pathlength in centimeters, and p is the pressure in pascals (Pa). (If p is measured in Torr, then $C = 1.5324 \times 10^{16}$.) Note that C has been evaluated for a temperature of 296 K, which is the temperature for which the intensities have been calculated in this atlas.

If the lineshape is dominated by pressure broadening, the percent transmission is again given by Eq. (3.37), but γ should be the pressure-broadened linewidth, γ_L , and C will be 7.789×10^{13} if p is in Pa (1.038×10^{16} if p is in Torr).

For the same linewidth and integrated intensity a Doppler-broadened line will have a peak intensity 1.476 times greater than a pressure-broadened line, even though the pressure broadened line is sharper.

For intermediate pressures the peak intensity can be more accurately estimated by modifying Eq. (3.37) so as to add the approximate contribution of both shapes according to

$$\% \text{ transmission} = 100 \exp\{-Slp[(1.1494 \times 10^{14}\gamma_D + 7.789 \times 10^{13}\gamma_L)/(\gamma_D^2 + \gamma_L^2)]\}. \quad (3.38)$$

Equation (3.38) reduces to Eq. (3.37) when either γ_D or γ_L dominates the lineshape.

The peak intensity observed with an instrument that introduces any instrumental broadening will, of course, be smaller than that calculated with either Eq.(3.37) or (3.38). As a rule of thumb, the peak intensity will be diminished by more than the ratio γ/γ_s , where γ is the true linewidth and γ_s is the width of the instrumental resolution function. Thus, for an instrument with a resolution

function that is ten times greater than the "true" linewidth, an absorption line will appear at least ten times weaker than what is calculated by either Eq. (3.37) or Eq. (3.38), provided the line is not saturated.

Pressure induced lineshifts

A good frequency calibration standard is one whose frequency is not changed as the measurement conditions are varied. Some of the absorption lines given in this atlas are weak enough to require that either long pathlengths or moderate pressures, 0.3 to 1.3 Pa (2 to 10 Torr), be used. It is important that one recognize the additional calibration uncertainty introduced by using pressures that are too high. Although pressure induced shifts in the frequency of the absorption lines are poorly understood and measurements are few and not very accurate, it is possible to estimate the approximate effect of moderate pressures on the frequencies of these calibration standards.

As a general rule, pressure induced frequency shifts are at least an order of magnitude smaller than pressure induced broadening. For the overtone of CO, Pollock *et al.* [5.304] found a pressure shift (due to CO) on the order of -2 ± 1.5 kHz/Pa (-0.3 ± 0.2 MHz/Torr). Bouanich [5.302] found pressure shifts on the order of -1.2 ± 0.3 kHz/Pa (-0.16 ± 0.04 MHz/Torr). He seems to have observed a significant rotational dependence, but we only quote an average value. For the overtone of NO, Pine *et al.* [5.370] found a self-induced pressure shift of -1.1 ± 0.3 kHz/Pa (-0.15 ± 0.04 MHz/Torr). They found that there may be a weak rotational dependence but it was obscured by experimental error.

For N₂O an attempt to measure the self-induced pressure shift in the rotational spectrum resulted in an estimate of an upper limit of 0.75 kHz/Pa [5.201]. The pressure shift of several lines of N₂O were measured near 4500 cm⁻¹ and an average value of -1.2 ± 0.3 kHz/Pa (-0.16 ± 0.04 MHz/Torr) was found [5.219]. The pressure shift caused by N₂ and O₂ on the ν_3 band of N₂O near 1280 cm⁻¹ was measured by Varanasi and Chudamani [5.238]. Their diode laser measurements gave an average value of about -0.6 ± 0.15 kHz/Pa (-0.08 MHz/Torr) for several lines between 1250 and 1300 cm⁻¹.

More pressure shift measurements seem to have been made on OCS than on any of the other molecules in this atlas. The earlier measurements indicated that the pressure shift was on the order of 0.5 MHz/Torr or less [5.94]. Later this estimate was improved by new measurements that gave an average value of -0.4 ± 1.5 kHz/Pa (-0.05 ± 0.20 MHz/Torr) [5.120]. The most recent measurements at about 1000 cm⁻¹ [5.133] indicate that the self-shift is -0.37 ± 0.04 kHz/Pa (-0.049 ± 0.005 MHz/Torr). Recent measurements of the self-shift of microwave transitions [5.119] found that the shift was too small to measure, 0.000 ± 0.04 kHz/Pa or 0.000 ± 0.006 MHz/Torr.

Kou and Guelachvili [3.23] have recently measured the self-induced pressure shift for the CO₂ laser lines near 1000 cm⁻¹. They found the shift to be on the order of -1.05 ± 0.2 kHz/Pa (-0.14 ± 0.03 MHz/Torr) with no evidence of a *J*-dependence. One might expect that the self-induced pressure-shift of CO₂ would be similar to that of the molecules used in the present compilation.

Since the pressure shift is a shift in the energy levels, it is likely to be greater as one goes to higher energy levels. As a first approximation one can probably assume that the shift is proportional to the frequency. It is also possible that for polyatomic molecules, the pressure shift may depend, to a large extent, on the vibrational mode involved.

For purposes of estimating the maximum error that could be introduced in a calibration measurement using any of the data given in this atlas, one should treat the frequencies given in this book as applying for a pressure below 130 Pa (1 Torr). For each increase in pressure of 130 Pa (1 Torr) the uncertainty in the frequency for N₂O, NO, CO, and CS₂ should be increased by 0.3 MHz unless the pressure shift is added to the frequencies given in these tables or unless more accurate values for the pressure shift become available. For OCS the uncertainty should be increased by about 0.1 MHz/Torr. Note that the pressure shift seems to be negative for all the molecules in this atlas.

References

- [3.1] J. L. Dunham, "The energy levels of a rotating vibrator," *Phys. Rev.* **41**, 721-731 (1932).
- [3.2] A. G. Maki and D. R. Lide, "Microwave and infrared measurements on HCN and DCN: observations on *l*-type resonance doublets," *J. Chem. Phys.* **47**, 3206-3210 (1967).
- [3.3] J. M. Brown, J.T. Hougen, K.-P. Huber, J. W. C. Johns, I. Kopp, H. Lefebvre-Brion, A. M. Merer, D. A. Ramsay, J. Rostas, and R. N. Zare, "The labeling of parity doublet levels in linear molecules," *J. Mol. Spectrosc.* **55**, 500-503 (1975).
- [3.4] W. F. Rowe and E. B. Wilson, "An Application of the Hellmann-Feynman Theorem to vibration-rotation interactions," *J. Mol. Spectrosc.* **56**, 163-165 (1975).
- [3.5] H. S. Peiser, N. E. Holden, P. De Bievre, I. L. Barnes, R. Hagemann, J. R. DeLaeter, T. J. Murphy, E. Roth, M. Shima, and H. G. Thode, "Element by element review of their atomic weights," *Pure Appl. Chem.* **56**, 696-768 (1984).
- [3.6] P. De Bievre, M. Gallet, N. E. Holden, and I. L. Barnes, "Isotopic abundances and atomic weights of the elements," *J. Phys. Chem. Ref. Data* **13**, 809-891 (1984).
- [3.7] R. S. McDowell, "Rotational partition functions for linear molecules," *J. Chem. Phys.* **88**, 356-361 (1988).
- [3.8] E. B. Wilson, J. C. Decius, and P. C. Cross, "*Molecular Vibrations - The Theory of Infrared and Raman Vibrational Spectra*," McGraw-Hill Book Co, Inc., New York, 1955.
- [3.9] W. Moffitt and A. D. Liehr, "Configurational instability of degenerate electronic states," *Phys. Rev.* **106**, 1195-1200 (1957).
- [3.10] R. H. Tipping, "Vibration-rotation intensities for "Hot" bands," *J. Mol. Spectrosc.* **61**, 272-281 (1976).
- [3.11] W. Gordy and R. L. Cook, "*Microwave Molecular Spectra*," John Wiley and Sons, New York, 1970.
- [3.12] C. H. Townes and A. L. Schawlow, "*Microwave Spectroscopy*," McGraw-Hill Book Co., New York, 1955.
- [3.13] C. Di Lauro and I. M. Mills, "Coriolis interactions about X-Y axes in symmetric tops," *J. Mol. Spectrosc.* **21**, 386-413 (1966).
- [3.14] A. G. Maki, W. B. Olson, and R. L. Sams, "HCN rotational-vibrational energy levels and intensity anomalies determined from infrared measurements," *J. Mol. Spectrosc.* **36**, 433-447 (1970).
- [3.15] R. Herman and R. F. Wallis, "Influence of vibration-rotation interaction on line intensities in vibration-rotation bands of diatomic molecules," *J. Chem. Phys.* **23**, 637-646 (1955).
- [3.16] R. H. Tipping and R. M. Herman, "Line intensities in HBr vibration-rotation spectra," *J. Mol. Spectrosc.* **36**, 404-413 (1970).
- [3.17] C. Young, "Calibration of the absorption coefficient for lines with combined Doppler and Lorentz broadening," *J. Quant. Spectrosc. Radiat. Transfer* **5**, 549-552 (1965).
- [3.18] S. R. Drayson, "Rapid computation of the Voigt profile," *J. Quant. Spectrosc. Radiat. Transfer* **16**, 611-614 (1976).
- [3.19] R. H. Dicke, "The effect of collisions upon the Doppler width of spectral lines," *Phys. Rev.* **89**, 472-473 (1953); J. P. Wittke and R. H. Dicke, "Redetermination of the hyperfine splitting in the ground state of atomic hydrogen," *Phys. Rev.* **103**, 620-631 (1956).
- [3.20] L. Galatry, "Simultaneous effect of Doppler and foreign gas broadening on spectral lines," *Phys. Rev.* **122**, 1218-1223 (1961).
- [3.21] S. G. Rautian and I. I. Sobelman, "The effect of collisions on the Doppler broadening of spectral lines," *Sov. Phys. Usp.* **9**, 701-716 (1967).

- [3.22] A. S. Pine and J. P. Looney, "N₂ and air broadening in the fundamental bands of HF and HCl," *J. Mol. Spectrosc.* **122**, 41-55 (1987).
- [3.23] Q. Kou and G. Guelachvili, "Self-induced pressure shifts in the 9.4- and 10.4- μ m bands of CO₂ by Fourier transform spectroscopy," *J. Mol. Spectrosc.* **148**, 324-328 (1991).

Chapter IV

ERROR ANALYSIS

The standards presented in this book are based on data derived in large part from frequency measurements because such measurements are less prone to systematic errors. In assessing the uncertainties that should be assigned to the recommended calibration frequencies, we must consider five major factors that may contribute to error in the determination of the line frequencies.

1. The accuracy of the calibration source.
2. The uncertainty in locating the center of the absorption line.
3. The accuracy of transferring the calibration to the line center measurement.
4. Errors caused by environmental effects.
5. Model errors, or uncertainties in the application of least-squares techniques to obtain the best estimate of the correct line frequency.

In succeeding paragraphs of this section each of these factors will be examined in relation to the calibration frequencies recommended in this book.

Accuracy of the Calibration Source

Much of the primary infrared data used for these tables originated at the NIST laboratory in Boulder, Colorado. Two other laboratories have reported heterodyne frequency measurements on the $2\nu_2$ band of OCS, [5.88, 5.126]. The most important of these were two saturated absorption measurements made by Fayt *et al.* [5.126] which considerably reduce the uncertainty in the frequencies for $2\nu_2$. The measurement of the laser transitions of N₂O by Whitford *et al.* [5.183] gave accurate frequencies for the separation of the ν_1 and ν_3 states which were useful for the tables between 880 and 980 cm⁻¹. Recently frequency measurements have been made by Urban and co-workers [5.321, 5.137a].

The NIST measurements used well characterized CO₂ lasers that were virtually identical to the lasers used by Petersen *et al.* [2.9, 2.11, 2.12] in the last major determination of the CO₂ laser frequencies. Since much of the laser technology that went into the determination of the CO₂ laser frequencies was developed in the same laboratory where the heterodyne measurements were made, one can be sure of the accuracy of the calibration source. These lasers have been described in Chapter II. The CO₂ laser frequencies are good to at least ± 0.05 MHz and are not a significant source of error for the Doppler limited heterodyne measurements.

Uncertainty in Locating the Line Center

Two major factors contribute to errors in the location or determination of absorption line centers: the signal-to-noise ratio, and the slope or other irregularities in the background.

For the infrared measurements the slope or irregular background in the radiation being absorbed was only a minor contributor to error since its effect could be practically eliminated, as described in Chapter II.

In some cases imperfectly resolved or overlapping lines were measured. In cases where the lines are close doublets, the measurement represents the center of gravity of the doublets, and the least-squares analysis took that into account. If the lines were partially resolved, that was taken into account in assigning the uncertainty for the measurement. In most cases partially resolved lines that have unequal intensities should not be used unless a very generous allowance is made for the uncertainty since the resulting error is not random, but is in a particular direction. OCS, CO, and CS₂ are good molecules to use for standards because they have no quadrupole fine structure. N₂O is not as good

because all of its transitions have a small quadrupole splitting. Since the splitting for N₂O is never greater than 4 MHz and diminishes rapidly with increasing *J*-values and since the Doppler full-width of N₂O at 500 cm⁻¹ is 28 MHz, the splitting should not affect the use of N₂O for most infrared calibration purposes.

For each infrared heterodyne frequency measurement two line centers must be measured: the absorption line center, and the center of the difference frequency (between the TDL and the local oscillator). The location of the absorption line center is determined by the technique used to lock the TDL to the absorption line as described in Chapter II. The uncertainty assigned to the line-center lock is given by half the Doppler-width of the line divided by the signal-to-noise ratio of the derivative signal for the line. Because of modulation broadening the linewidth is slightly greater than the Doppler-width but this approximation to the lock uncertainty is adequate. The lock error is random and is reflected in the statistical analysis of the least-squares fit of many measurements.

More important than the uncertainty in locking to the line center is the uncertainty in the difference frequency measurements. That uncertainty is given by one-tenth the beat note linewidth, or by half the beat note width divided by the signal-to-noise ratio, whichever is larger. We believe this covers both random and residual systematic errors for a single measurement. In most of our measurements, this has been the predominant uncertainty and the lock uncertainty has been negligible by comparison.

One source of error in the heterodyne measurements that has no direct counterpart in wavelength measurements is due to frequency-dependent differences in the transmission or amplification components involved in the heterodyne frequency measurements. This frequency dependence sometimes presented an additional distortion to the heterodyne frequency lineshape as displayed by the spectrum analyzer. Fortunately this error, which would be systematic for all measurements of the same heterodyne frequency, becomes randomized if enough different lines are measured. In most cases this problem was recognized and was taken into account in estimating the uncertainty of each measurement.

Examination of our results over the past decade indicates that the procedure outlined above for assigning the uncertainty produced values which turned out to be close to a two sigma uncertainty.

For the microwave and sub-millimeter wave measurements used to prepare these tables, the uncertainties given in the literature are generally accurate enough although we have increased the uncertainties slightly in a few cases. There may be some systematic error due to incomplete modulation when Stark modulation was used, but this is compensated by the much smaller linewidths, and the smaller frequency dependent irregularities, compared to the infrared measurements.

Accuracy of Transferring the Calibration to the Line Center Measurement

The primary difference in the reliability of wavelength and frequency measurements is in the accuracy of transferring the calibration to the measurement. In frequency measurements the accuracy of the measurements is not affected by beam dimensions, by wavefront mismatch or other misalignments, or by refractive index effects. The frequency of the radiation is always the same no matter what the medium may be, or how it is measured. Modern electronics excel at counting, and that is how frequency is determined. With frequency measurements, if a measurement can be made at all, the uncertainty must come from the four other sources of error discussed in this chapter.

On the other hand, wavelength comparisons are susceptible to many different wavelength-dependent errors, errors due to misalignment, errors due to differences in the ratio of the dimensions of the optical elements (or of the optical beam), to the wavelength. The best wavelength measurements use a calibration that is nearly the same wavelength and intensity as the feature to be calibrated. Each type of wavelength measurement has its own peculiarities.

The present tables are based in part on higher order centrifugal distortion constants determined to some extent by FTS measurements which are essentially wavelength measurements. These

measurements were all internally calibrated by means of lines whose frequency could be determined by heterodyne frequency measurements. These calibration features were always within the approximately 120 cm^{-1} band-pass of the FTS measurements. For the FTS measurements there may be a phase error which is different for weak features and for strong features and that is one reason why greater emphasis was placed on the use of frequency measurements of pure rotational transitions to determine the rotational constants wherever possible. In no case were FTS measurements used to determine the band centers or vibrational levels for the lines recommended as frequency standards.

Errors Caused by Environmental Effects

For closed shell molecules the only significant environmental effects are due to pressure shifts and electric field effects such as either the *ac* or *dc* Stark effects. As long as the radiation field (for absorption spectra) is too low to give saturated absorption effects, the *ac* Stark effect can be ignored in its effect on the absorption line center. Even the *dc* Stark effect can be ignored for most work since stray electric fields are generally too small to give noticeable Stark shifts.

We believe that even in the case of the saturated absorption measurements on the 2-0 band of CO, the shift due to the *ac* Stark effect will be smaller than a tenth of the linewidth, or less than 0.2 MHz.

The *ac* Stark effect may have a small effect on the frequency of the CO₂ lasers but, since those lasers have the same characteristics as the lasers used in the original measurements against the cesium frequency standard, the effect of the shift will already be included in the frequency assigned to the laser lines. In the case of the CO transfer oscillators, the CO frequencies are measured at the same time as the beat note frequency measurement and any *ac* shift is included in the measurement.

On the other hand, the effect of pressure induced shifts is potentially significant and deserves serious consideration. Pressure-induced shifts in infrared spectra have not been extensively studied, so there is no experimentally confirmed theory that one can use to calculate the pressure shifts to be expected for much of the data given in the present tables. All of the pressure shift measurements seem to indicate that the shift for the transitions given in these tables may be on the order of -2.2 kHz/Pa (-0.3 MHz/Torr) or less. Only in the case of the measurements given by Vanek *et al.* [9.133] is the shift of $-0.37 \pm 0.04\text{ kHz/Pa}$ ($-49 \pm 5\text{ kHz/Torr}$) reliably given for the $2\nu_2$ band of OCS. Since neither the frequency dependence nor the rotational or vibrational dependence of the pressure shift is known, this remains one of the most important uncertainties in the application of these tables to real measurements.

Uncertainties in the Application of Least-squares Techniques

Because individual measurements of infrared absorption lines by heterodyne measurement techniques are not very precise (uncertainties of the order of 5 to 10 MHz for some regions) and only a small number of transitions can be measured, it is necessary to use least-squares techniques to combine all available measurements to yield calculated transitions that are considerably more accurate than any one measurement. Such fitting techniques can be no more accurate than the equations used to describe the transitions (the Hamiltonian). The molecules and the particular transitions in these tables were chosen in part because of the reliability of the Hamiltonian as shown by extensive studies reported in the literature. Although certain interactions, such as Fermi resonance, affect the constants used in the effective Hamiltonian, such resonances can be ignored, provided that measurements are available for a wide range of rotational levels for each vibrational state. In the analysis used in this book the effect of *l*-type resonance was included because it represents the largest resonance effect and it can be reliably estimated, thereby giving the correct functional form to the centrifugal distortion constants. The details of the fitting procedure and Hamiltonian are given in Chapter III.

The variance-covariance matrix determined by the least-squares fit gives a reliable estimate of the uncertainties of the transitions in the range of rotational levels for which there are good measurements. The calculated uncertainties get large quite rapidly for transitions extrapolated beyond the range of measured energy levels, but the reliability of those calculated uncertainties deteriorates even more quickly. For that reason we have terminated the recommended calibration standard indication at the highest J -value for which there are good measurements. Higher transitions are given in the tables but their accuracy is less certain.

Summary

Of the five sources of error identified above, the first (the accuracy of the calibration source) does not contribute significantly to the uncertainties in the calibration frequencies given in these tables. For frequency measurements the second and third source (uncertainty in locating the line center and accuracy of transferring the calibration) will appear as random errors and so will be given by the statistical analysis of the least-squares fit of the measurements. For the molecules and bands represented in these tables the uncertainties contributed by model errors are small and likely to show as deviations that are included in the statistical analysis.

In conclusion we think that the uncertainties given by the statistical analysis are adequate to describe the errors in the frequency measurements that might arise from all causes except errors due to pressure-induced frequency shifts. Most of the heterodyne measurements were made at low pressures but some measurements of weaker transitions were made at pressures as great as 1200 Pa (9 Torr). To allow an extra margin of error due to pressure shifts, the uncertainties assigned to the heterodyne frequency measurement data used in the fit were about twice as large as the rms deviation. Primarily, this had the effect of increasing the uncertainty in the vibrational energy levels.

Chapter V

BIBLIOGRAPHY

We attempt here to list all references to papers giving infrared or microwave frequency (or wavenumber) measurements, as well as lineshape and intensity measurements that are relevant to this atlas. Papers involving bands not included in this atlas may be missing from this bibliography. Some papers are not included if they involve foreign gas broadening measurements only. For a more complete listing of pressure broadening papers see the review given by Smith *et al.* [5.2]. When completely superseded, some of the older papers may not appear in this bibliography but they can be found referenced in the more recent papers. The references are grouped by molecule and arranged in chronological order for each molecule. At the end of each reference is a list of initials that indicate the subject matter covered by the reference as follows:

- F - frequency measurements,
- FB - foreign gas broadening measurements,
- I - intensity measurements,
- LS - laser-Stark measurements,
- PS - pressure shift measurements,
- SB - self-broadening measurements,
- T - theory, and
- W - wavenumber or wavelength measurements.

Intensity and Pressure Broadening Bibliographies

- [5.1] L. A. Pugh and K. Narahari Rao, in "*Molecular Spectroscopy: Modern Research*," Vol. II (K. Narahari Rao, ed.), pp. 165-227 Academic Press, New York (1976) I.
- [5.2] M. A. H. Smith, C. P. Rinsland, B. Fridovich, and K. Narahari Rao, in "*Molecular Spectroscopy: Modern Research*," Vol. III (K. Narahari Rao, ed.), pp. 111-248. Academic Press, San Diego (1985) I,FB,SB.

Microwave Tables and Bibliographies

- [5.3] A. G. Maki, "Microwave spectra of molecules of astrophysical interest VI. Carbonyl sulfide and hydrogen cyanide," *J. Phys. Chem. Ref. Data* **3**, 221-244 (1974) F.
- [5.4] F. J. Lovas, "Microwave spectral tables. I. Diatomic molecules," *J. Phys. Chem. Ref. Data* **3**, 609-770 (1974) F.
- [5.5] F. J. Lovas, "Microwave spectral tables. II. Triatomic molecules," *J. Phys. Chem. Ref. Data* **7**, 1445-1750 (1978) F.

OCS

- [5.6] A. Roberts, "Rotational spectrum of OC¹⁴S and the nuclear spin of C¹⁴," *Phys. Rev.* **73**, 1405 (1948) F.
- [5.7] C. H. Townes, A. N. Holden, and F. R. Merritt, "Microwave spectra of some linear XYZ molecules," *Phys. Rev.* **74**, 1113-1133 (1948) F.
- [5.8] M. W. P. Strandberg, T. Wentink, and R. L. Kyhl, "Rotational absorption spectrum of OCS," *Phys. Rev.* **75**, 270-278 (1949) F.
- [5.9] W. Low and C. H. Townes, "O¹⁷ and S³⁶ in the rotational spectrum of OCS," *Phys. Rev.* **529-530** (1949) F.
- [5.10] T. Wentink, W. S. Koski, and V. W. Cohen, "The Mass of S³⁵ from microwave spectroscopy," *Phys. Rev.* **81**, 948-951 (1951) F.

- [5.11] C. M. Johnson, R. Trambarulo, and W. Gordy, "Microwave spectroscopy in the region from two to three millimeters, part II," *Phys. Rev.* **84**, 1178-1180 (1951) F.
- [5.12] D. Z. Robinson, "The experimental determination of the intensities of infrared absorption bands. IV. Measurements of the stretching vibrations of OCS and CS₂," *J. Chem. Phys.* **19**, 881-886 (1951) I.
- [5.13] H. J. Callomon, D. C. McKean, and H. W. Thompson, "Intensities of vibration bands. IV. Carbonyl sulphide and acetylene," *Proc. Roy. Soc. (London)* **A208**, 341-351 (1951) I.
- [5.14] D. C. McKean, H. J. Callomon, and H. W. Thompson, "Intensities of vibration bands of carbonyl sulfide and carbon disulfide," *J. Chem. Phys.* **20**, 520 (1951) I.
- [5.15] S. Geschwind, G. R. Gunther-Mohr, and G. Silvey, "The spin and quadrupole moment of O¹⁷," *Phys. Rev.* **85**, 474-477 (1952) F.
- [5.16] J. R. Eshbach, R. E. Hillger, and M. W. P. Strandberg, "The nuclear magnetic moment of S³³ from microwave spectroscopy," *Phys. Rev.* **85**, 532-539 (1952) F.
- [5.17] S. J. Tetenbaum, "Six-millimeter spectra of OCS and N₂O," *Phys. Rev.* **88**, 772-774 (1952) F.
- [5.18] B. F. Burke, M. W. P. Strandberg, V. W. Cohen, and W. S. Koski, "The nuclear magnetic moment of S³⁵ by microwave spectroscopy," *Phys. Rev.* **93**, 193-194 (1954) F.
- [5.19] W. C. King and W. Gordy, "One-to-two millimeter wave spectroscopy. IV. Experimental methods and results for OCS, CH₃F, and H₂O," *Phys. Rev.* **93**, 407-412 (1954) F.
- [5.20] C. A. Burrus and W. Gordy, "Submillimeter wave spectroscopy," *Phys. Rev.* **93**, 897-898 (1954) F.
- [5.21] E. C. Wingfield and J. W. Straley, "Intensity of the bending mode in carbonyl sulfide," *J. Chem. Phys.* **22**, 1949-1950 (1954) I.
- [5.22] W. Low, "Fermi resonance in the microwave spectrum of linear XYZ molecules," *Phys. Rev.* **97**, 1664-1667 (1955) F.
- [5.23] H. C. Allen, E. K. Plyler, and L. R. Blaine, "Infrared spectrum of carbonyl sulfide," *J. Chem. Phys.* **26**, 400-403 (1957) W.
- [5.24] A. G. Maki, E. K. Plyler, and E. D. Tidwell, "Vibration-rotation bands of carbonyl sulfide," *J. Res. N.B.S.* **66A**, 163-167 (1962) W.
- [5.25] E. A. Triaille, "Spectres de vibration-rotation a haute resolution du ¹⁶O¹³C³²S entre 3650 cm⁻¹ et 7000 cm⁻¹," *Ann. Soc. Scient. Bruxelles* **79**, 193-221 (1965) W.
- [5.26] E. A. Triaille and C. P. Courtoy, "Further evidence for perturbations in the infrared spectra of carbonyl sulfide," *J. Mol. Spectrosc.* **18**, 118-128 (1965) W.
- [5.27] T. F. Deutsch, "OCS molecular laser," *Appl. Phys. Lett.* **8**, 334-335 (1966) W.
- [5.28] H. Yamada and W. B. Person, "Absolute infrared intensities of some linear triatomic molecules in the gas phase," *J. Chem. Phys.* **45**, 1861-1865 (1966) I.
- [5.29] Y. Morino and C. Matsumura, "Microwave spectra and equilibrium structure of carbonyl sulfide," *Bull. Chem. Soc. Japan* **40**, 1095-1100 (1967) F.
- [5.30] R. H. Hill, D. E. Kaplan, G. F. Herrmann, and S. K. Ichiki, "Emission microwave spectroscopy: OCS," *Phys. Rev. Lett.* **18**, 105-107 (1967) F.
- [5.31] L. H. Scharpen, J. S. Muentzer, and V. W. Laurie, "Determination of the polarizability anisotropy of OCS by microwave spectroscopy," *J. Chem. Phys.* **46**, 2431-2434 (1967) F.
- [5.32] A. G. Maki, "Measurement of the direct *l*-doublet transitions in carbonyl sulfide," *J. Mol. Spectrosc.* **23**, 110-111 (1967) F.
- [5.33] B. T. Berendts and A. Dymanus, "Evaluation of molecular quadrupole moments from broadening of microwave spectral lines. I. Measurements," *J. Chem. Phys.* **48**, 1361-1367 (1968) SB,FB.
- [5.34] A. Fayt, "Resonance anharmonique du troisieme ordre dans le OCS," *Ann. Soc. Scient. Bruxelles* **82**, 101-112 (1968) W.

- [5.35] Y. Morino and T. Nakagawa, "Least-squares determination of the anharmonic potential constants of carbonyl sulfide," *J. Mol. Spectrosc.* **26**, 496-523 (1968) T,F,W.
- [5.36] J. S. Murphy and J. E. Boggs, "Collision broadening of rotational absorption lines. III. Broadening by linear molecules and inert gases and the determination of molecular quadrupole moments," *J. Chem. Phys.* **49**, 3333-3343 (1968) SB,FB.
- [5.37] C. C. Costain, "The use of saturation dip absorption in microwave spectroscopy and in microwave frequency stabilization," *Can. J. Phys.* **47**, 2431-2433 (1969) F.
- [5.38] L. H. Sharpen, J. S. Muentner, and V. W. Laurie, "Electric polarizability anisotropies of nitrous oxide, propyne, and carbonyl sulfide by microwave spectroscopy," *J. Chem. Phys.* **53**, 2513-2519 (1970) F.
- [5.39] A. Fayt, "Spectres infrarouges de l'oxysulfure de carbone entre 2400 et 7000 cm^{-1} ," *Ann. Soc. Scient. Bruxelles* **84**, 69-106 (1970) W.
- [5.40] F. Meyer-Bourbonneux and C. Meyer, "Constantes vibrorotationnelles des trois especes isotopiques OCS^{32} , OCS^{33} , OCS^{34} ," *Compt. Rend.* **270**, 1224-1226 (1970) W.
- [5.41] R. S. Winton and W. Gordy, "High-precision millimeter-wave spectroscopy with the Lamb dip," *Phys. Lett.* **32A**, 219-220 (1970) F.
- [5.42] F. H. De Leeuw and A. Dymanus, "Electric and Magnetic Properties of OCS measured by molecular-beam electric-resonance spectroscopy," *Chem. Phys. Lett.* **7** 288-292 (1970) F.
- [5.43] P. Helminger, F. C. DeLucia, and W. Gordy, "Extension of microwave absorption spectroscopy to 0.37-mm wavelength," *Phys. Rev. Lett.* **25**, 1397-1399 (1970) F.
- [5.44] I. C. Story, V. I. Metchnik, and R. W. Parsons, "The measurement of the widths and pressure-induced shifts of microwave spectral lines," *J. Phys. B* **4**, 593-608 (1971) PS, SB, FB.
- [5.45] A. Fayt and R. Vandenhoute, "Spectres infrarouges et analyse vibro-rotationnelle du $^{16}\text{O}^{13}\text{C}^{32}\text{S}$," *Ann. Soc. Scient. Bruxelles* **85**, 105-116 (1971) W.
- [5.46] A. Fayt, "Molecular constants of carbonyl sulfide," *Ann. Soc. Scient. Bruxelles* **86**, 61-88 (1972) W.
- [5.47] J. M. L. J. Reinartz, W. L. Meerts, and A. Dymanus, "Electric and magnetic properties of OCS in the (01^10) vibrational state measured by molecular-beam electric-resonance spectroscopy," *Chem. Phys. Lett.* **16**, 576-580 (1972) F.
- [5.48] A. G. Maki and D. R. Johnson, "Microwave spectra of carbonyl sulfide: measurements of ground state and vibrationally excited $^{16}\text{O}^{13}\text{C}^{32}\text{S}$, $^{18}\text{O}^{12}\text{C}^{32}\text{S}$, and other isotopic species," *J. Mol. Spectrosc.* **47**, 226-233 (1973) F.
- [5.49] A. Foord and D. H. Whiffen, "Dipole moment function of carbonyl sulphide," *Mol. Phys.* **26**, 959-968 (1973) I.
- [5.50] H. Taft, P. Bhattacharyya, N. Smith, and B. P. Dailey, "High resolution microwave studies of the magnetic properties of OCS," *Chem Phys. Lett.* **22**, 113-117 (1973) F.
- [5.51] R. E. Davis and J. S. Muentner, "The rotational magnetic moment for the $J=1,2,3,4$ and 5 states of OCS," *Chem. Phys. Lett.* **24**, 343-345 (1974) F.
- [5.52] J. M. L. J. Reinartz and A. Dymanus, "Molecular constants of OCS isotopes in the (01^10) vibrational state measured by molecular-beam electric-resonance spectroscopy," *Chem. Phys. Lett.* **24**, 346-351 (1974) F.
- [5.53] M. Bogey, A. Bauer, and S. Maes, "Observation of rotational transitions in the ν_3 state of OCS through vibrational energy transfer from activated nitrogen," *Chem. Phys. Lett.* **24**, 516-519 (1974) F.
- [5.54] B. Fabricant and J. S. Muentner, "l-type doubling transitions in Δ and Φ states of OCS," *J. Mol. Spectrosc.* **53**, 57-61 (1974) F.
- [5.55] N. W. Larsen and B. P. Winnewisser, "Millimeter wave rotational transitions of $^{16}\text{O}^{12}\text{C}^{32}\text{S}$ and $^{16}\text{O}^{13}\text{C}^{32}\text{S}$," *Z. Naturforsch. A* **29**, 1213-1215 (1974) F.

- [5.56] M. Bogey, "Microwave absorption spectroscopy in the ν_3 states of OCS and N_2O through energy transfer from N_2^* ," *J. Phys. B* **8**, 1934-1938 (1975) F.
- [5.57] R. J. Butcher, R. B. Dennis, and S. D. Smith, "The tunable spin-flip Raman laser II. Continuous wave molecular spectroscopy," *Proc. Roy. Soc. (London) A* **344**, 541-561 (1975) W,SB.
- [5.58] R. A. Creswell, S. R. Brown, and R. H. Schwendeman, "Linewidths in OCS: isotope effects, vibrational effects, temperature dependence, and T_1/T_2 ," *J. Chem. Phys.* **64**, 1820-1827 (1976) SB.
- [5.59] K. A. Davis and J. Overend, "The general quartic valence force field of OCS," *Spectrochim. Acta A* **32**, 233-240 (1976) W,T.
- [5.60] A. G. Maki and S. M. Freund, "Laser Stark measurements on OCS including the observation of zero-field-forbidden $\Delta J=0, \pm 2$ transitions," *J. Mol. Spectrosc.* **62**, 90-98 (1976) LS.
- [5.61] F. Meyer-Bourbonneux, J. Dupre-Maquaire, and C. Meyer, "Molecular constants of some levels of the ν_2 mode of carbonyl sulfide," *J. Mol. Spectrosc.* **63**, 288-305 (1976) W.
- [5.62] K. Nakagawa, T. Nakagawa, Y. Ueda, and K. Kuchitsu, "Laser Stark spectroscopy of OCS in the $9.5 \mu\text{m}$ region," *J. Mol. Spectrosc.* **63**, 547-552 (1976) LS.
- [5.63] W. R. MacGillivray, "The measurement of widths and pressure-induced shifts of rotational lines in the microwave region," *J. Phys. B* **9**, 2511-2520 (1976) PS, SB.
- [5.64] D. H. Whiffen, "Computation of centrifugal distortion constants from the force field; example of carbonyl sulphide," *Mol. Phys.* **31**, 989-1000 (1976) T.
- [5.65] A. Fayt and R. Vandenhoute, "Infra-red spectra and rovibrational analysis of $^{18}\text{O}^{12}\text{C}^{32}\text{S}$," *Mol. Phys.* **31**, 1861-1873 (1976) W.
- [5.66] J. G. Smith, "Centrifugal distortion of carbonyl sulphide in excited vibrational states," *J. Chem. Soc. Faraday Trans. II* **72**, 2298-2300 (1976) F.
- [5.67] S. C. M. Luijendijk, "On the shape of pressure-broadened absorption lines in the microwave region II. Collision-induced width and shift of some rotational absorption lines as a function of temperature," *J. Phys. B* **10**, 1741-1747 (1977) PS, SB.
- [5.68] P. L. Hewitt, "Width and shift measurements in the microwave spectra of NH_3 , CH_3Cl , and OCS," *J. Quant. Spectrosc. Radiat. Transfer* **17**, 227-232 (1977) PS, SB.
- [5.69] A. Fayt, D. Van Lerberghe, J. P. Kupfer, H. Pascher, and H. G. Hafele, "Analysis of vibration-rotation bands of OCS in the $5.3 \mu\text{m}$ region using a tunable Q-switched spin-flip Raman laser," *Mol. Phys.* **33**, 603-610 (1977) W.
- [5.70] P. G. Buckley, J. H. Carpenter, A. McNeish, J. D. Muse, J. J. Turner, and D. H. Whiffen, "High resolution infrared spectroscopy using a spin-flip Raman laser: the bands of carbonyl sulphide near 1890cm^{-1} ," *J. Chem. Soc. Faraday Trans. II* **74**, 129-135 (1978) W.
- [5.71] K. Tanaka and T. Tanaka, "Laser microwave double resonance spectroscopy of OCS with a $9.4\text{-}\mu\text{m}$ CO_2 laser - Precise measurement of Dipole moment in the 03^10 vibrational state," *J. Mol. Spectrosc.* **69**, 335-340 (1978) F,LS.
- [5.72] F. Herlemont, M. Lyszyk, and J. Lemaire, "Infrared spectroscopy of OCS, SO_2 , O_3 with a CO_2 waveguide laser," *J. Mol. Spectrosc.* **77**, 69-75 (1979) F.
- [5.73] J. S. Wells, F. R. Petersen, and A. G. Maki, "Heterodyne frequency measurements with a tunable diode laser- CO_2 laser spectrometer: spectroscopic reference frequencies in the $9.5 \mu\text{m}$ band of carbonyl sulfide," *Appl. Opt.* **18**, 3567-3573 (1979) F,I.
- [5.74] W. G. Mankin, M. T. Coffey, D. W. T. Griffith, and S. R. Drayson, "Spectroscopic measurement of carbonyl sulfide (OCS) in the stratosphere," *Geophys. Res. Lett.* **6**, 853-856 (1979) I,FB.
- [5.75] G. Guelachvili, "Nombres d'ondes absolus de la bande ν_3 de $^{16}\text{O}^{12}\text{C}^{32}\text{S}$ par spectroscopie de Fourier," *Opt. Commun.* **30**, 361-363 (1979) W.

- [5.76] G. Blanquet, J. Walrand, and C. P. Courtoy, "The ν_3 band of $^{16}\text{O}^{12}\text{C}^{34}\text{S}$ and $^{16}\text{O}^{13}\text{C}^{34}\text{S}$," *J. Mol. Spectrosc.* **81**, 473-479 (1980) W.
- [5.77] B. M. Landsberg, "New optically pumped cw submillimeter emission lines from OCS CH_3OH and CH_3OD ," *IEEE J. Quant. Elect.* **QE-16**, 704-706 (1980) W.
- [5.78] M. Bogey and A. Bauer, "Microwave spectroscopy of OCS in highly excited vibrational states through energy transfer from N_2 ," *J. Mol. Spectrosc.* **84**, 170-178 (1980) F.
- [5.79] A. Dubrulle, J. Demaison, J. Burie, and D. Boucher, "The millimeter wave rotational spectra of carbonyl sulfide," *Z. Naturforsch. A* **35**, 471-474 (1980) F.
- [5.80] W. A. Wensink, C. Noorman, and H. A. Dijkerman, "Self-shifting of some rotational transitions of OCS and CH_3CCH (propyne). A survey of measurements on shifting of rotational absorption lines of molecules," *J. Phys. B* **14**, 2813-2821 (1981) F,PS.
- [5.81] M. Sergent-Rozey and Nguyen-Van-Thanh, "Pure rotational spectrum of carbonyl sulfide in the far-infrared," *Infrared Phys.* **21**, 221-224 (1981) W.
- [5.82] A. V. Burenin, E. N. Karyakin, A. F. Krupnov, S. M. Shapin, and A. N. Valdov, "Submillimeter microwave spectrum and spectroscopic constants of the OCS molecule," *J. Mol. Spectrosc.* **85**, 1-7 (1981) F.
- [5.83] J. S. Wells, F. R. Petersen, A. G. Maki, and D. J. Suckle, "Heterodyne frequency measurements on the 11.6- μm band of OCS: new frequency/wavelength calibration tables for 11.6- and 5.8- μm OCS bands," *Appl. Opt.* **20**, 1676-1684 (1981) and **20**, 2874 (1981) F,I.
- [5.84] A. V. Burenin, A. N. Val'dov, E. N. Karyakin, A. F. Krupnov, and S. M. Shapin, "Submillimeter microwave spectrum and spectroscopic constants of the OCS molecule," *J. Mol. Spectrosc.* **87**, 312-315 (1981) F.
- [5.85] V. Malathy Devi, P. P. Das, A. Bano, and K. Narahari Rao, "Diode laser measurements of strengths of $^{16}\text{O}^{12}\text{C}^{32}\text{S}$ lines at 12 μm ," *J. Mol. Spectrosc.* **87**, 578-581 (1981) I,SB.
- [5.86] Nguyen-van-Thanh, J.-P. Bouanich, I. Rossi, and H. Strapelias, "Intensity and dipole correlation functions for the ν_3 band of compressed OCS," *Can. J. Phys.* **59**, 1563-1568 (1981) I,SB.
- [5.87] J. S. Wells, F. R. Petersen, A. G. Maki, and D. J. Suckle, "Heterodyne frequency measurements (at 11.6 μm) on isotopic species of carbonyl sulfide, OC^{34}S , O^{13}CS , OC^{33}S , ^{18}OCS , and $\text{O}^{13}\text{C}^{34}\text{S}$," *J. Mol. Spectrosc.* **89**, 421-429 (1981) F,W.
- [5.88] J. P. Sattler, T. L. Worchesky, A. G. Maki, and W. J. Lafferty, "Heterodyne frequency measurements on carbonyl sulfide near 1050 cm^{-1} ," *J. Mol. Spectrosc.* **90**, 460-466 (1981) F,W.
- [5.89] R. H. Kagann, "Infrared absorption intensities for OCS," *J. Mol. Spectrosc.* **94**, 192-198 (1982) I.
- [5.90] J. Kauppinen, K. Jolma, and V.-M. Horneman, "New wave-number calibration tables for H_2O , CO_2 , and OCS lines between 500 and 900 cm^{-1} ," *Appl. Opt.* **21**, 3332-3336 (1982) W.
- [5.91] W. Klebsch, K. Yamada, and G. Winnewisser, "Diode laser spectrum of OCS: the ν_1 band at 2062 cm^{-1} ," *Z. Naturforsch. A* **38**, 157-162 (1983) W.
- [5.92] R. P. Leavitt and J. P. Sattler, "Pressure Broadening of OCS in the 10 μm region," *J. Quant. Spectrosc. Radiat. Transfer* **29**, 179-181 (1983) SB.
- [5.93] A. Picard-Bersellini, B. J. Whitaker, and Ph. Brechignac, "Rotational inelastic transitions in OCS using a tunable diode laser and a frequency doubled CO_2 laser," *J. Chem. Phys.* **79**, 1556-1557 (1983) SB.
- [5.94] J. S. Wells, F. R. Petersen, and A. G. Maki, "Heterodyne frequency measurements of carbonyl sulfide transitions at 26 and 51 THz. Improved OCS, O^{13}CS , and OC^{34}S molecular constants," *J. Mol. Spectrosc.* **98**, 404-412 (1983) F,W,PS.
- [5.95] W. Klebsch, K. Yamada, and G. Winnewisser, "Diode laser spectrum of OCS in a dc discharge," *J. Mol. Spectrosc.* **99**, 479-481 (1983) W.

- [5.96] K. Jolma, J. Kauppinen, and V.-M. Horneman, "Vibration-rotation bands of CO₂ and OCS in the region 540-890 cm⁻¹," *J. Mol. Spectrosc.* **101**, 300-305 (1983) W.
- [5.97] K. Tanaka, H. Ito, K. Harada, and T. Tanaka, "CO₂ and CO laser microwave double resonance spectroscopy of OCS: precise measurement of dipole moment and polarizability anisotropy," *J. Chem. Phys.* **80**, 5893-5905 (1984) LS,F.
- [5.98] K. Tanaka, H. Ito, and T. Tanaka, "Millimeter wave spectroscopy of OCS in vibrationally excited states," *J. Mol. Spectrosc.* **107**, 324-332 (1984) F.
- [5.99] S. C. Mehrotra and H. Mader, "Study of T₂ relaxation for *l*-doublet transitions of ¹³C¹⁶OCS," *Can. J. Phys.* **62**, 1280-1285 (1984) F,SB.
- [5.100] K. Tanaka, T. Tanaka, and I. Suzuki, "Dipole moment function of carbonyl sulfide from analysis of precise dipole moments and infrared intensities," *J. Chem. Phys.* **82**, 2835-2844 (1985) LS,I
- [5.101] N. Hunt, S. C. Foster, J. W. C. Johns, and A. R. W. McKellar, "High-resolution spectroscopy of 16 bands of OCS in the region 1975-2140 cm⁻¹ for diode laser calibration," *J. Mol. Spectrosc.* **111**, 42-53 (1985) W,I.
- [5.102] K. Jolma, V.-M. Horneman, J. Kauppinen, and A. G. Maki, "Absolute OCS wavenumbers and analysis of bands in the region of the lowest fundamental ν_2 ," *J. Mol. Spectrosc.* **113**, 167-174 (1985) W.
- [5.103] J.-P. Bouanich, G. Blanquet, J. Walrand, and C. P. Courtoy, "Diode laser measurements of line strengths and collisional half-widths in the ν_1 band of OCS at 298 and 200 K," *J. Quant. Spectrosc. Radiat. Transfer* **36**, 295-306 (1986) I,SB.
- [5.104] M. Dang-Nhu and G. Guelachvili, "Intensities des raies d'absorption dans la bande $\nu_2 + \nu_3$ de ¹⁶O¹²C³²S," *Mol. Phys.* **58**, 535-540 (1986) W,I.
- [5.105] A. Fayt, R. Vandenhoute, and J.-G. Lahaye, "Global rovibrational analysis of carbonyl sulfide," *J. Mol. Spectrosc.* **119**, 233-266 (1986) F,LS,W.
- [5.106] J.-G. Lahaye, R. Vandenhoute, and A. Fayt, "CO₂ laser saturation Stark spectra and global Stark analysis of carbonyl sulfide," *J. Mol. Spectrosc.* **119**, 267-279 (1986) LS.
- [5.107] A. G. Maki, J. S. Wells, and A. Hinz, "Heterodyne frequency measurements on the 12⁰-00⁰ band of OCS," *Int. J. Infrared Millimeter Waves* **7**, 909-917 (1986) F.
- [5.108] B. Lamalle, P. Suzeau, F. Truchetet, and J. Chanussot, "Utilisation d'un asservissement de frequence pour la determination precise des parametres de decalage et d'elargissement de la raie J:2→3 d'OCS en fonction de la pression," *Can. J. Phys.* **65**, 452-457 (1987) SB,PS.
- [5.109] G. Blanquet, F. Derie, and J. Walrand, "Diode-laser spectrum of isotopic carbonyl sulfide OC³⁴S in the region of 847 cm⁻¹," *J. Mol. Spectrosc.* **123**, 14-25 (1987) W.
- [5.110] J.-P. Bouanich, J. Walrand, S. Albery, and G. Blanquet, "Diode-laser measurements of oxygen-broadened linewidths in the ν_1 band of OCS," *J. Mol. Spectrosc.* **123**, 37-47 (1987) FB.
- [5.111] J.-G. Lahaye, R. Vandenhoute, and A. Fayt, "CO₂ laser saturation Stark spectra and global rovibrational analysis of the main isotopic species of carbonyl sulfide (OC³⁴S, O¹³CS, and ¹⁸OCS)," *J. Mol. Spectrosc.* **123**, 48-83 (1987) LS.
- [5.112] L. S. Masukidi, J.-G. Lahaye, B. Coveliers, and A. Fayt, "Intracavity CO-laser Stark spectrometer from 2063 to 1228 cm⁻¹," *J. Opt. Soc. Am. B* **4**, 1177-1180 (1987) LS.
- [5.113] I. Merke and H. Dreizler, "Determination of quadrupole and spin-rotation coupling in the rotational spectrum of carbonylsulfide-³³S and ⁻¹⁷O," *Z. Naturforsch. A* **42**, 1043-1044 (1987) F.
- [5.114] F. J. Lovas and R. D. Suenram, "Pulsed beam Fourier transform microwave measurements on OCS and rare gas complexes of OCS with Ne, Ar, and Kr," *J. Chem. Phys.* **87**, 2010-2020 (1987) F.

- [5.115] K. M. T. Yamada and W. Klebsch, "High-temperature spectrum of OCS in a dc discharge by diode laser spectroscopy," *J. Mol. Spectrosc.* **125**, 380-392 (1987) W.
- [5.116] J.-P. Bouanich, C. Campers, G. Blanquet, and J. Walrand, "Diode-laser measurements of Ar- and CO₂-broadened linewidths in the ν_1 band of OCS," *J. Quant. Spectrosc. Radiat. Transfer* **39**, 353-365 (1988) FB.
- [5.117] J.-P. Bouanich and G. Blanquet, "Pressure broadening of CO and OCS spectral lines," *J. Quant. Spectrosc. Radiat. Transfer* **40**, 205-220 (1988) T,SB,FB.
- [5.118] J. C. Depannemaecker and J. Lemaire, "Measurement with a double-beam spectrometer of strengths and half-widths of $2\nu_2$ and $3\nu_2-\nu_2$ OCS lines," *J. Mol. Spectrosc.* **128**, 350-359 (1988) I,SB.
- [5.119] J. P. M. De Vreede, M. P. W. Gillis, and H. A. Dijkerman, "Linewidth, lineshift, and lineshape measurements on rotational transitions of OCS using frequency modulation," *J. Mol. Spectrosc.* **128**, 509-520 (1988) F,SB,PS.
- [5.120] A. G. Maki, Wm. B. Olson, J. S. Wells, and M. D. Vanek, "Heterodyne and FTS measurements on the OCS hot bands near 1890 cm⁻¹," *J. Mol. Spectrosc.* **130**, 69-80 (1988) F,W,PS.
- [5.121] M. Schneider, A. G. Maki, M. D. Vanek, and J. S. Wells, "Heterodyne measurements on OCS near 1327 cm⁻¹," *J. Mol. Spectrosc.* **134**, 349-353 (1989) F.
- [5.122] J. S. Wells, M. D. Vanek, and A. G. Maki, "Heterodyne frequency and Fourier transform spectroscopy measurements on OCS near 1700 cm⁻¹," *J. Mol. Spectrosc.* **135**, 84-88 (1989) F,W.
- [5.123] J. P. Bouanich, "Diode laser measurements of He-broadened linewidths in the ν_1 band of OCS," *J. Quant. Spectrosc. Radiat. Transfer* **42**, 319-326 (1989) FB.
- [5.124] M. D. Vanek, D. A. Jennings, J. S. Wells, and A. G. Maki, "Frequency measurements of high-J rotational transitions of OCS and N₂O," *J. Mol. Spectrosc.* **138**, 79-83 (1989) F.
- [5.125] J. S. Wells, M. Schneider, and A. G. Maki, "Heterodyne frequency measurements on OCS near 61.76 THz (2060 cm⁻¹)," *J. Mol. Spectrosc.* **140**, 170-176 (1990) F.
- [5.126] A. Fayt, J.-G. Lahaye, J. Lemaire, F. Herlemont, and J. G. Bantegnie, "Waveguide and diode heterodyne measurements with CO₂ laser and assignment of the CW FIR laser emission of OCS," *J. Mol. Spectrosc.* **140**, 252-258 (1990) F.
- [5.127] G. Blanquet, J. Walrand, I. Hilgers, and D. Lambot, "Spectral intensities in the ν_1 band of carbonyl sulfide and its isotopic species," *J. Mol. Spectrosc.* **140**, 295-300 (1990) I.
- [5.128] A.-M. Tolonen, V.-M. Horneman, and S. Alanko, "Absolute OCS wavenumbers and analysis of bands in the region of the overtone $2\nu_2$," *J. Mol. Spectrosc.* **144**, 18-26 (1990) W.
- [5.129] A. G. Maki, J. S. Wells, and D. A. Jennings, "Heterodyne frequency measurements on CO and OCS beyond 2100 cm⁻¹," *J. Mol. Spectrosc.* **144**, 224-229 (1990) F.
- [5.130] G. Blanquet, J. Walrand, J.-P. Bouanich, and C. Boulet, "Line-mixing effects in Ar-broadened doublets of a hot band of OCS," *J. Chem. Phys.* **93**, 6962-6970 (1990) FB.
- [5.131] G. Blanquet, J. Walrand, and J.-P. Bouanich, "Diode laser measurements of Kr-broadened linewidths in the ν_1 band of OCS," *Appl. Opt.* **29**, 5366-5371 (1990) FB.
- [5.132] A. G. Maki, J. S. Wells, and J. B. Burkholder, "High resolution measurements of the bands of carbonyl sulfide between 2510 and 3150 cm⁻¹," *J. Mol. Spectrosc.* **147**, 173-181 (1991) W,I.
- [5.133] M. D. Vanek, J. S. Wells, and A. G. Maki, "Pressure dependent lineshift measurements on OCS," *J. Mol. Spectrosc.* **147**, 398-405 (1991) PS,PB,F.
- [5.134] G. Blanquet, P. Coupe, F. Derie, and J. Walrand, "Spectral intensities in the $2\nu_2^0$ band of carbonyl sulfide," *J. Mol. Spectrosc.* **147**, 543-545 (1991) I.
- [5.135] T. L. Tan and E. C. Looi, "FTIR measurements on the $3\nu_2-\nu_2$ band of carbonyl sulfide," *J. Mol. Spectrosc.* **148**, 262-264 (1991) W.

- [5.136] T. L. Tan, E. C. Looi, and K. T. Lua, "Hot-band spectrum of OCS near 850 cm⁻¹," *J. Mol. Spectrosc.* **148**, 265-269 (1991) W.
- [5.137] L. S. Masukidi, J. G. Lahaye, and A. Fayt, "Intracavity CO laser Stark spectroscopy of the ν_3 band of carbonyl sulfide," *J. Mol. Spectrosc.* **148**, 281-302 (1991) LS.
- [5.137a] A. Dax, M. Mürtz, M. Schaefer, M. Schneider, E. M. Bachem, W. Urban, J. S. Wells, and A. Maki, "Extension of Heterodyne measurements to 3.3 μm ," (to be published) F.

N₂O

- [5.138] D. K. Coles, E. S. Elyash, and J. G. Gorman, "Microwave absorption spectra of N₂O," *Phys. Rev.* **72**, 973 (1947) F.
- [5.139] D. K. Coles and R. H. Hughes, "Microwave spectra of nitrous oxide," *Phys. Rev.* **76**, 178A (1949) F.
- [5.140] R. G. Shulman, B. P. Dailey, and C. H. Townes, "Molecular dipole moments and Stark effects III. dipole moment determinations," *Phys. Rev.* **78**, 145-148 (1950) F.
- [5.141] H. W. Thompson and R. L. Williams, "Vibration-rotation bands of nitrous oxide," *Proc. Roy. Soc. (London) A* **208**, 326-331 (1951) W.
- [5.142] H. J. Callomon, D. C. McKean, and H. W. Thompson, "Intensities of vibration bands III. nitrous oxide," *Proc. Roy. Soc. (London) A* **208**, 332-341 (1951) I.
- [5.143] R. M. Goody and T. W. Wormell, "The quantitative determination of atmospheric gases by infra-red spectroscopic methods I. Laboratory determination of the absorption of 7.8 and 8.6 μ bands of nitrous oxide with dry air as a foreign gas," *Proc. Roy. Soc. (London) A* **209**, 178-196 (1951) I,FB.
- [5.144] D. F. Eggers and B. L. Crawford, "Vibrational intensities. III. Carbon dioxide and nitrous oxide," *J. Chem. Phys.* **19**, 1554-1561 (1951) I.
- [5.145] C. M. Johnson, R. Trambarulo, and W. Gordy, "Microwave spectroscopy in the region from two to three millimeters, part II," *Phys. Rev.* **84**, 1178-1180 (1951) F.
- [5.146] S. J. Tetenbaum, "Six-millimeter spectra of OCS and N₂O," *Phys. Rev.* **88**, 772-774 (1952) F.
- [5.147] K. Lakshmi, K. Narahari Rao, and H. H. Nielsen, "Molecular constants of nitrous oxide from measurements of ν_2 at 17 μ ," *J. Chem. Phys.* **24**, 811-813 (1956) W.
- [5.148] C. A. Burrus and W. Gordy, "Millimeter and submillimeter wave spectroscopy," *Phys. Rev.* **101**, 599-602 (1956) F.
- [5.149] K. Narahari Rao and H. H. Nielsen, "Fermi diad 10⁰ and 02⁰ of nitrous oxide," *Can. J. Phys.* **34**, 1147-1152 (1956) W.
- [5.150] E. D. Tidwell, E. K. Plyler, and W. S. Benedict, "Vibration-rotation bands of N₂O," *J. Opt. Soc. Am.* **50**, 1243-1263 (1960) W.
- [5.151] D. E. Burch and D. Williams, "Total absorptance of nitrous oxide bands in the infrared," *Appl. Opt.* **1**, 473-482 (1962) I.
- [5.152] P. E. Fraley, W. W. Brimm, and K. Narahari Rao, "Vibration-rotation bands of N₂¹⁴O¹⁶ at 4.5 μ ," *J. Mol. Spectrosc.* **9**, 487-493 (1962) W.
- [5.153] K. Narahari Rao, R. V. DeVore, and E. K. Plyler, "Wavelength calibrations in the far infrared (30 to 1000 microns)," *J. Res. NBS* **67A**, 351-358 (1963) W.
- [5.154] E. K. Plyler, E. D. Tidwell, and A. G. Maki, "Infrared absorption spectrum of nitrous oxide (N₂O) from 1830 cm⁻¹ to 2270 cm⁻¹," *J. Res. NBS* **68A**, 79-86 (1964) W.
- [5.155] R. P. Grosso and T. K. McCubbin, "The ν_1 -2 ν_2 Fermi diads of N₂¹⁴O¹⁶, N¹⁵N¹⁴O¹⁶, and N₂¹⁵O¹⁶," *J. Mol. Spectrosc.* **13**, 240-255 (1964) W.
- [5.156] W. J. Lafferty and D. R. Lide, "Rotational constants of excited states of ¹⁴N₂O," *J. Mol. Spectrosc.* **14**, 407-408 (1964) F.
- [5.157] H. Yamada and W. B. Person, "Absolute infrared intensities of some linear triatomic molecules in the gas phase," *J. Chem. Phys.* **45**, 1861-1865 (1966) I.

- [5.158] B. T. Berendts and A. Dymanus, "Evaluation of molecular quadrupole moments from broadening of microwave spectral lines. I. Measurements," *J. Chem. Phys.* **48**, 1361-1367 (1968) SB,FB.
- [5.159] I. P. French and T. E. Arnold, "Foreign-gas broadening of the $J=5 \rightarrow 6$ rotational transition of nitrous oxide," *J. Mol. Spectrosc.* **27**, 218-224 (1968) SB, FB.
- [5.160] J. S. Murphy and J. E. Boggs, "Collision broadening of rotational absorption lines. III. Broadening by linear molecules and inert gases and the determination of molecular quadrupole moments," *J. Chem. Phys.* **49**, 3333-3343 (1968) SB,FB.
- [5.161] R. Pearson, T. Sullivan, and L. Frenkel, "Microwave spectrum and molecular parameters for $^{14}\text{N}_2^{16}\text{O}$," *J. Mol. Spectrosc.* **34**, 440-449 (1970) F.
- [5.162] L. H. Sharpen, J. S. Muentner, and V. W. Laurie, "Electric polarizability anisotropies of nitrous oxide, propyne, and carbonyl sulfide by microwave spectroscopy," *J. Chem. Phys.* **53**, 2513-2519 (1970) F.
- [5.163] J. Lemaire, J. Houriez, J. Thibault, and B. Maillard, "Double irradiation des molecules de bromure de methyle et de protoxyde d'azote par rayonnements infrarouge et Hertzien," *J. Phys. (Paris)* **32**, 35-40 (1971) F.
- [5.164] L. D. Gray Young, "Calculation of the partition function for $^{14}\text{N}_2^{16}\text{O}$," *J. Quant. Spectrosc. Radiat. Transfer* **11**, 1265-1270 (1971) T.
- [5.165] G. D. T. Tejwani and P. Varanasi, "Theoretical line widths in $\text{N}_2\text{O}-\text{N}_2\text{O}$ and N_2O -air collisions," *J. Quant. Spectrosc. Radiat. Transfer* **11**, 1659-1664 (1971) T.
- [5.166] R. A. Toth, "Line strengths on N_2O in the 2.9 micron region," *J. Mol. Spectrosc.* **40**, 588-604 (1971) I.
- [5.167] R. A. Toth, "Self-broadened and N_2 broadened linewidths of N_2O ," *J. Mol. Spectrosc.* **40**, 605-615 (1971) SB,FB.
- [5.168] C. L. Tien, M. F. Modest, and C. R. McCreight, "Infrared radiation properties of nitrous oxide," *J. Quant. Spectrosc. Radiat. Transfer* **12**, 267-277 (1972) I.
- [5.169] L. D. Gray Young, "Relative intensity calculations for nitrous oxide," *J. Quant. Spectrosc. Radiat. Transfer* **12**, 307-322 (1972) I,T.
- [5.170] J. S. Margolis, "Intensity and half width measurements of the (00^2-00^0) band of N_2O ," *J. Quant. Spectrosc. Radiat. Transfer* **12**, 751-757 (1972) I,SB,FB.
- [5.171] J. E. Lowder, "Band intensity and line half-width measurements in N_2O near 4.5μ ," *J. Quant. Spectrosc. Radiat. Transfer* **12**, 873-880 (1972) I,FB.
- [5.172] N. Lacome, C. Boulet, and E. Arie, "Spectroscopie par source laser. III. Intensities et largeurs des raies de la transition 00^1-10^0 du protoxyde d'azote. Ecarts a la forme de Lorentz," *Can. J. Phys.* **51**, 302-310 (1973) I,SB.
- [5.173] J. Walrand, G. Blanquet, and C. P. Courtoy, "Spectres infrarouge a haute resolution du protoxyde d'azote $^{14}\text{N}^{15}\text{N}^{16}\text{O}$ etude de la band ν_3 ," *Ann. Soc. Scient. Bruxelles* **87**, 409-419 (1973) W.
- [5.174] L. D. Tubbs and D. Williams, "Broadening of infrared absorption lines at reduced temperatures, III. Nitrous oxide," *J. Opt. Soc. Am.* **63**, 859-863 (1973) I,SB.
- [5.175] R. Farrenq and J. Dupre-Maquaire, "Vibrational luminescence of N_2O excited by dc discharge - rotation-vibration constants," *J. Mol. Spectrosc.* **49**, 268-279 (1974) W.
- [5.176] R. Farrenq, D. Gaultier, and C. Rossetti, "Vibrational luminescence of N_2O excited by dc discharge - emission lines intensities and populations of rotational-vibrational levels," *J. Mol. Spectrosc.* **49**, 280-288 (1974) I.
- [5.177] N. Lacome, "Line shape in the 00^1-10^0 band of nitrous oxide and carbon dioxide: contribution of the "hot band" 01^1-11^0 to its determination," *Can. J. Phys.* **52**, 470-471 (1974) I,SB.

- [5.178] P. Varanase and B. P. Bangaru, "Measurement of line intensities of linear molecules under low resolution," *J. Quant. Spectrosc. Radiat. Transfer* **14**, 1253-1257 (1974) I.
- [5.179] A. V. Burenin, A. N. Valbov, L. I. Gershtein, E. N. Karyakin, A. F. Krupnov, A. V. Maslovskii, and S. M. Shchapin, "Submillimeter spectrum and intermolecular parameters," *Opt. Spectrosc.* **37**, 676-678 (1974) F.
- [5.180] C. Amiot and G. Guelachvili, "Vibration-rotation bands of $^{14}\text{N}_2\text{O}$: 1.2 micron-3.3 micron region," *J. Mol. Spectrosc.* **51**, 475-491 (1974) W.
- [5.181] J. M. Krell and R. L. Sams, "Vibration-rotation bands of nitrous oxide: 4.1 micron region," *J. Mol. Spectrosc.* **51**, 492-507 (1974) W.
- [5.182] K. H. Casleton and S. G. Kukolich, "Beam maser measurements of hyperfine structure in $^{14}\text{N}_2\text{O}$," *J. Chem. Phys.* **62**, 2696-2699 (1975) F.
- [5.183] B. G. Whitford, K. J. Siemsen, H. D. Riccius, and G. R. Hanes, "Absolute frequency measurements of N_2O laser transitions," *Opt. Commun.* **14**, 70-74 (1975) F.
- [5.184] G. Blanquet, J. Walrand, and C. P. Courtoy, "Bandes de vibration-rotation de formes isotopiques de N_2O dans la region de $4.5 \mu\text{m}$," *Ann. Soc. Scient. Bruxelles* **89**, 93-114 (1975) W.
- [5.185] R. A. Toth and C. B. Farmer, "Line strengths of H_2O and N_2O in the 1900 cm^{-1} region," *J. Mol. Spectrosc.* **55**, 182-191 (1975) I.
- [5.186] M. Bogey, "Microwave absorption spectroscopy in the ν_3 states of OCS and N_2O through energy transfer from N_2^* ," *J. Phys. B* **8**, 1934-1938 (1975) F.
- [5.187] J. P. Boissy, A. Valentin, P. Cardinet, M. L. Claude, and A. Henry, "Line intensities of the ν_3 fundamental band of nitrous oxide," *J. Mol. Spectrosc.* **57**, 391-396 (1975) I.
- [5.188] J. Perrizo, L. A. Pugh, and K. Narahari Rao, "Bands of nitrous oxide at $5.3 \mu\text{m}$," *J. Mol. Spectrosc.* **57**, 397-401 (1975) W.
- [5.189] J. Dupre-Maquaire and P. Pinson, "Emission spectrum of N_2O in the $8 \mu\text{m}$ range," *J. Mol. Spectrosc.* **58**, 239-249 (1975) W.
- [5.190] A. Valentin, M.-F. Le Moal, P. Cardinet, and J.-P. Boissy, "High precision spectrum of N_2O at $4.5 \mu\text{m}$ and determination of molecular constants for the ν_3 and the $(\nu_2 + \nu_3 - \nu_2)$ bands," *J. Mol. Spectrosc.* **59**, 96-102 (1976) W.
- [5.191] C. Amiot and G. Guelachvili, "Extension of the 10^6 samples Fourier spectrometry to the indium antimonide region: vibration-rotation bands of $^{14}\text{N}_2^{16}\text{O}$: $3.3\text{-}5.5 \mu\text{m}$ region," *J. Mol. Spectrosc.* **59**, 171-190 (1976) W.
- [5.192] C. Amiot, "Vibration-rotation bands of $^{14}\text{N}^{15}\text{N}^{16}\text{O}$ - $^{15}\text{N}^{14}\text{N}^{16}\text{O}$: $1.6\text{-}5.7 \mu\text{m}$ region," *J. Mol. Spectrosc.* **59**, 191-208 (1976) W.
- [5.193] C. Amiot, "Vibration-rotation bands of $^{15}\text{N}_2^{16}\text{O}$ - $^{14}\text{N}_2^{18}\text{O}$," *J. Mol. Spectrosc.* **59**, 380-395 (1976) W.
- [5.194] B. A. Andreev, A. V. Burenin, E. N. Karyakin, A. F. Krupnov, and S. M. Shapin, "Submillimeter wave spectrum and molecular constants of N_2O ," *J. Mol. Spectrosc.* **62**, 125-148 (1976) F.
- [5.195] A. Chedin, C. Amiot, and Z. Cihla, "The potential energy function of the nitrous oxide molecule using pure vibrational data," *J. Mol. Spectrosc.* **63**, 348-369 (1976) T.
- [5.196] K. Siemsen and J. Reid, "New N_2O laser band in the $10 \mu\text{m}$ wavelength region," *Opt. Commun.* **20**, 284-288 (1977) F.
- [5.197] T. Kunitomo, S. Ueoka, H. Masuzaki, K. Utsunomiya, and M. Osumi, "Emissivity and band-model parameters for infrared bands of nitrous oxide," *J. Quant. Spectrosc. Radiat. Transfer* **18**, 405-417 (1977) I.
- [5.198] P. Varanasi and F. K. Ko, "Intensity and transmission measurements in the ν_3 fundamental of N_2O at low temperatures," *J. Quant. Spectrosc. Radiat. Transfer* **18**, 465-470 (1977) I.

- [5.199] N. Lacombe and A. Levy, "A parametric deconvolution method: application to two bands of N₂O in the 1.9- μ m region," *J. Mol. Spectrosc.* **71**, 175-192 (1978) I,SB.
- [5.200] W. B. Person and K. C. Kim, "Measurements of some line positions and strengths in the ν_4 region of SF₆," *J. Chem. Phys.* **69**, 1764-1769 (1978) I.
- [5.201] W. A. Wensink, C. Noorman, and H. A. Dijkerman, "Self-broadening and self-shifting of some rotational transitions of CF₃H and N₂O," *J. Phys. B* **12**, 1687-1699 (1979) SB,PS.
- [5.202] K. G. P. Sulzmann, J. M. Kline, and S. S. Penner, "Empirical determinations of the effective absorption coefficients for the NO γ -bands at 2259 A and the ν_3 fundamental of N₂O at 4.52 μ ," *J. Quant. Spectrosc. Radiat. Transfer* **21**, 475-482 (1979) I.
- [5.203] M. J. Reisfeld and H. Flicker, "The ν_2 band of N₂O as a frequency standard in the 17- μ m region of the infrared," *Appl. Opt.* **18**, 1136-1138 (1979) W.
- [5.204] N. Lacombe and A. Levy, "High-pressure absorption spectrum of N₂O in the 2 μ m region," *Mol. Phys.* **39**, 1221-1232 (1980) I,SB,T.
- [5.205] I. Suzuki, "Dipole moment functions of carbon dioxide and nitrous oxide," *J. Mol. Spectrosc.* **80**, 12-22 (1980) I,T.
- [5.206] Nguyen-Van-Thanh, J.-P. Bouanich, and I. Rossi, "The ν_3 and $2\nu_3$ IR bandshapes and dipole correlation functions of compressed gaseous N₂O; intensity measurements of the $2\nu_3$ band," *Mol. Phys.* **40**, 869-881 (1980) I.
- [5.207] D. B. Braund, A. R. H. Cole, J. A. Cugley, F. R. Honey, R. E. Pulfrey, and G. D. Reece, "Precise measurements with a compact vacuum infrared spectrometer," *Appl. Opt.* **19**, 2146-2152 (1980) W.
- [5.208] N. Lacombe and A. Levy, "Line strengths and self-broadening linewidths of N₂O in the 2- μ m region - 24⁰0-00⁰ and 01¹2-00⁰ transitions," *J. Mol. Spectrosc.* **85**, 205-214 (1981) I,SB.
- [5.209] M. O. Bulanin, V. P. Bulychev, and E. B. Khodos, "Determination of the parameters of the vibrational-rotational lines of the 00⁰1-10⁰ band of nitrous oxide," *Opt. Spectrosc. (USSR)* **56**, 595-597 (1982) I,SB,FB.
- [5.210] W. B. Olson, A. G. Maki, and W. J. Lafferty, "Tables of N₂O absorption lines for the calibration of tunable infrared lasers from 522 cm⁻¹ to 657 cm⁻¹ and from 1115 cm⁻¹ to 1340 cm⁻¹," *J. Phys. Chem. Ref. Data* **10**, 1065-1084 (1981) W.
- [5.211] Da-Wun Chen, E. R. Niple, and S. K. Poultney, "Determining tunable diode laser spectrometer performance through measurement of N₂O line intensities and widths at 7.8 μ m," *Appl. Opt.* **21**, 2906-2911 (1982) I,SB,FB.
- [5.212] C. P. Rinsland, A. Goldman, F. J. Murcray, D. G. Murcray, M. A. H. Smith, R. K. Seals, J. C. Larsen, and P. L. Rinsland, "Stratospheric N₂O mixing ratio profile from high-resolution balloon-borne solar absorption spectra and laboratory spectra near 1880 cm⁻¹," *Appl. Opt.* **21**, 4351-4355 (1982) I.
- [5.213] G. Guelachvili, "Absolute N₂O wavenumbers between 1118 and 1343 cm⁻¹ by Fourier transform spectroscopy," *Can. J. Phys.* **60**, 1334-1347 (1982) W.
- [5.214] R. H. Kagann, "Infrared absorption intensities for N₂O," *J. Mol. Spectrosc.* **95**, 297-305 (1982) I.
- [5.215] K. Jolma, J. Kauppinen, and V.-M. Horneman, "Vibration-rotation spectrum of N₂O in the region of the lowest fundamental ν_2 ," *J. Mol. Spectrosc.* **101**, 278-284 (1983) W.
- [5.216] A. Levy, N. Lacombe, and G. Guelachvili, "Measurement of N₂O line strengths from high-resolution Fourier transform spectra," *J. Mol. Spectrosc.* **103**, 160-175 (1984) I.
- [5.217] N. Lacombe, A. Levy, and G. Guelachvili, "Fourier transform measurement of self-, N₂-, and O₂-broadening of N₂O lines: temperature dependence of linewidths," *Appl. Opt.* **23**, 425-435 (1984) SB,FB.
- [5.218] R. A. Toth, "Line strengths of N₂O in the 1120-1440 cm⁻¹ region," *Appl. opt.* **23**, 1825-1834 (1984) I.

- [5.219] C. R. Pollock, F. R. Petersen, D. A. Jennings, J. S. Wells, and A. G. Maki, "Absolute frequency measurements of the 00^02-00^00 , 20^01-00^00 , and 12^01-00^00 bands of N_2O by heterodyne spectroscopy," *J. Mol. Spectrosc.* **107**, 62-71 (1984) F,PS.
- [5.220] L. R. Brown and R. A. Toth, "Comparison of the frequencies of NH_3 , CO_2 , H_2O , N_2O , CO , and CH_4 as infrared calibration standards," *J. Opt. Soc. Am. B* **2**, 842-856 (1985) W.
- [5.221] J. S. Wells, D. A. Jennings, A. Hinz, J. S. Murray, and A. G. Maki, "Heterodyne frequency measurements on N_2O at 5.3 and 9.0 μm ," *J. Opt. Soc. Am. B* **2**, 857-861 (1985) F.
- [5.222] M. Margottin-Maclou, P. Dahoo, A. Henry, and L. Henry, "Self-broadening parameters in the ν_3 band of $^{14}N_2^{16}O$," *J. Mol. Spectrosc.* **111**, 275-290 (1985) I, SB.
- [5.223] A. Henry, M. Margottin-Maclou, and N. Lacome, " N_2 - and O_2 -Broadening parameters in the ν_3 band of $^{14}N_2^{16}O$," *J. Mol. Spectrosc.* **111**, 291-300 (1985) FB.
- [5.224] J. S. Wells, A. Hinz, and A. G. Maki, "Heterodyne frequency measurements on N_2O between 1257 and 1340 cm^{-1} ," *J. Mol. Spectrosc.* **114**, 84-96 (1985) F.
- [5.225] R. A. Toth, "Frequencies of N_2O in the 1100- to 1440- cm^{-1} region," *J. Opt. Soc. Am. B* **3**, 1263-1281 (1986) W.
- [5.226] M. Loewenstein, J. R. Podolske, T. E. Blackburn, and P. Varanasi, "Diode laser Measurements of line strengths and widths in the 4.5- μm bands of N_2O ," *J. Quant. Spectrosc. Radiat. Transfer* **35**, 231-235 (1986) I,FB.
- [5.227] A. Bauer, J. L. Teffo, A. Valentin, and T. K. McCubbin, "The ground state rotational constants of $^{15}N^{15}N^{16}O$," *J. Mol. Spectrosc.* **120**, 449-454 (1986) F,W.
- [5.228] M. Kobayashi and I. Suzuki, "Dipole moment function of nitrous oxide," *J. Mol. Spectrosc.* **122**, 157-170 (1987) I,T.
- [5.229] R. A. Toth, " N_2O vibration-rotation parameters derived from measurements in the 900-1090- and 1580-2380- cm^{-1} regions," *J. Opt. Soc. Am. B* **4**, 357-374 (1987) W.
- [5.230] L. R. Zink, J. S. Wells, and A. G. Maki, "Heterodyne frequency measurements on N_2O near 1060 cm^{-1} ," *J. Mol. Spectrosc.* **123**, 426-433 (1987) F.
- [5.231] A. Hinz, J. S. Wells, and A. G. Maki, "Heterodyne measurements of hot bands and isotopic transitions of N_2O near 7.8 μm ," *Z. Phys. D* **5**, 351-358 (1987) F.
- [5.232] J. M. Colmont and N. Semmoud-Monnanteuil, "Pressure broadening of the N_2O $J=9\leftarrow 8$ rotational transition by N_2O , N_2 , and O_2 ," *J. Mol. Spectrosc.* **126**, 240-242 (1987) SB,FB.
- [5.233] M. P. Esplin, W. M. Barowy, R. J. Huppi, and G. A. Vanasse, "High resolution Fourier spectroscopy of nitrous oxide at elevated temperatures," *Mikrochim. Acta (Wien)* **403-407** (1988) W.
- [5.234] P. Varanasi, "Measurement of the absolute intensities of the 7.8 and 8.6 μm band systems of N_2O ," *J. Quant. Spectrosc. Radiat. Transfer* **39**, 189-191 (1988) I.
- [5.235] L. L. Strow and A. S. Pine, "Q-branch line mixing in N_2O : Effects of l -type doubling," *J. Chem. Phys.* **89**, 1427-1434 (1988) I,SB,FB.
- [5.236] V. V. Zhurov, V. V. Kovtun, and N. N. Kudryavtsev, "Measurement of the intensities and collisional broadening of rotational lines of the 4.5 μm band of N_2O with the help of a tunable semiconductor laser," *J. Appl. Spectrosc.* **50**, 151-156 (1989) I,SB.
- [5.237] Lai-Wa Tang, S. Nadler, and S. J. Daunt, "Tunable diode laser measurements of absolute line strengths in the $2\nu_2$ band of N_2O near 8 μm ," *J. Quant. Spectrosc. Radiat. Transfer* **41**, 97-101 (1989) I.
- [5.238] P. Varanasi and S. Chudamani, "Measurement of pressure-induced shifts of infrared lines with a tunable diode laser," *J. Quant. Spectrosc. Radiat. Transfer* **41**, 173-176 (1989) PS.
- [5.239] P. Varanasi and S. Chudamani, "Tunable diode laser measurements of line widths in the ν_1 -fundamental band of $^{14}N_2^{16}O$ at atmospheric temperatures," *J. Quant. Spectrosc. Radiat. Transfer* **41**, 351-357 (1989) FB.

- [5.240] P. Varanasi and S. Chudamani, "Line strength measurements in the ν_1 -fundamental band of $^{14}\text{N}_2^{16}\text{O}$ using a tunable diode laser," *J. Quant. Spectrosc. Radiat. Transfer* **41**, 359-362 (1989) I.
- [5.241] M. D. Vanek, M. Schneider, J. S. Wells, and A. G. Maki, "Heterodyne measurements on N_2O near 1635 cm^{-1} ," *J. Mol. Spectrosc.* **134**, 154-158 (1989) F.
- [5.242] M. D. Vanek, D. A. Jennings, J. S. Wells, and A. G. Maki, "Frequency measurements of high-J rotational transitions of OCS and N_2O ," *J. Mol. Spectrosc.* **138**, 79-83 (1989) F.
- [5.243] A. G. Maki, J. S. Wells, and M. D. Vanek, "Heterodyne frequency measurements on N_2O near 930 cm^{-1} ," *J. Mol. Spectrosc.* **138**, 84-88 (1989) F.
- [5.244] M. Margottin-Maclou, A. Henry, and A. Valentin, "Line mixing effects in the self- and N_2 -broadened Q-branch of the $\nu_2+\nu_3$ band of N_2O ," *Appl. Opt.* **28**, 4920-4923 (1989) SB,FB.
- [5.245] K. M. T. Yamada, "Pure rotation spectrum of NNO in the far infrared region," *Z. Naturforsch.* **A45**, 837-838 (1990) W.

CO

- [5.246] O. R. Gilliam, C. M. Johnson, and W. Gordy, "Microwave spectroscopy in the region from two to three millimeters," *Phys. Rev.* **78**, 140-144 (1950) F.
- [5.247] C. M. Johnson, R. Trambarulo, and W. Gordy, "Microwave spectroscopy in the region from two to three millimeters, part II," *Phys. Rev.* **84**, 1178-1180 (1951) F.
- [5.248] I. M. Mills and H. W. Thompson, "The fundamental vibration-rotation bands of $^{13}\text{C}^{16}\text{O}$ and $^{12}\text{C}^{18}\text{O}$," *Trans. Faraday Soc.* **49**, 224-227 (1953) W.
- [5.249] E. K. Plyler, L. R. Blaine, and W. S. Connor, "Velocity of light from the molecular constants of carbon monoxide," *J. Opt. Soc. Am.* **45**, 102-106 (1955) W.
- [5.250] W. Gordy and M. J. Cowan, "Precision measurements of millimeter and submillimeter wave lines of CO," *Bull. Amer. Phys. Soc.* **2**, 212-213 (1957) F.
- [5.251] B. Rosenblum and A. H. Nethercot, "Quadrupole coupling constant and molecular structure of CO^{17} ," *J. Chem. Phys.* **27**, 828-829 (1957) F.
- [5.252] D. H. Rank, A. H. Guenther, G. D. Saksena, J. N. Shearer, and T. A. Wiggins, "Tertiary interferometric wavelength standards from measurements on lines of the 2-0 band of carbon monoxide and derived wavelength standards for some lines of the 1-0 band of carbon monoxide. The velocity of light derived from a band spectrum method. IV," *J. Opt. Soc. Am.* **47**, 686-689 (1957) W.
- [5.253] B. Rosenblum, A. H. Nethercot, and C. H. Townes, "Isotopic mass ratios, magnetic moments and sign of the electric dipole moment of carbon monoxide," *Phys. Rev.* **109**, 400-412 (1958) F.
- [5.254] C. A. Burrus, "Stark effect from 1.1 to 2.6 millimeters wavelength: PH_3 , PD_3 , DI, and CO," *J. Chem. Phys.* **28**, 427-429 (1958) F.
- [5.255] W. S. Benedict, R. Herman, G. E. Moore, and S. Silverman, "The strengths, widths, and shapes of lines in the vibration-rotation bands of CO," *Astrophys. J.* **135**, 277-297 (1962) I,SB,FB.
- [5.256] J. H. Shaw and J. T. Houghton, "Total band absorptance of CO near $4.7\ \mu$," *Appl. Opt.* **3**, 773-779 (1964) I,SB,FB.
- [5.257] D. H. Rank, A. G. St.Pierre, and T. A. Wiggins, "Rotational and vibration constants of CO," *J. Mol. Spectrosc.* **18**, 418-427 (1965) W.
- [5.258] J. M. Weinberg, E. S. Fishburne, and K. Narahari Rao, "'Hot' bands of CO at 4.7 microns measured to high J values," *J. Mol. Spectrosc.* **18**, 428-442 (1965) W.
- [5.259] L. A. Young and W. J. Eachus, "Dipole moment function and vibration-rotation matrix elements for CO," *J. Chem. Phys.* **44**, 4195-4206 (1966) I,T.

- [5.260] W. H. Flygare and V. W. Weiss, "¹³C spin-rotation interaction and magnetic shielding in the carbon and oxygen nuclei in formaldehyde," *J. Chem. Phys.* **45**, 2785-2792 (1966) F.
- [5.261] L. Hochard-Demolliere, "Mesure de la dispersion dans la bande fondamentale de l'oxyde de carbone," *J. Phys. (Paris)* **27**, 341-344 (1966) I.
- [5.262] J-P. Bouanich, A. Levy, and C. Haeusler, "Constantes Moleculaires de l'oxyde de carbone," *J. Phys. (Paris)* **29**, 641-645 (1968) W,SB,I.
- [5.263] C. L. Korb, R. H. Hunt, and E. K. Plyler, "Measurement of line strengths at low pressures-Application to the 2-0 band of CO," *J. Chem. Phys.* **48**, 4252-4260 (1968) I.
- [5.264] I. Ozier, L. M. Crapo, and N. F. Ramsey, "Spin rotation constant and rotational magnetic moment of ¹³C¹⁶O," *J. Chem. Phys.* **49**, 2314-2321 (1968) F.
- [5.265] R. A. Toth, R. H. Hunt, and E. K. Plyler, "Line intensities in the 3-0 band of CO and dipole moment matrix elements for the CO molecule," *J. Mol. Spectrosc.* **32**, 85-96 (1969) I,T.
- [5.266] P. Helminger, F. C. DeLucia, and W. Gordy, "Extension of microwave absorption spectroscopy to 0.37-mm wavelength," *Phys. Rev. Lett.* **25**, 1397-1399 (1970) F.
- [5.267] J.-P. Bouanich, "Determination experimental des largeurs et des déplacements des raies de la bande 0→2 de CO perturbe par les gaz rares (He, Ne, Ar, Kr, Xe)," *J. Quant. Spectrosc. Radiat. Transfer* **12**, 1609-1615 (1972) FB,PS.
- [5.268] J.-P. Bouanich and C. Brodbeck, "Mesure des largeurs et des déplacements des raies de la bande 0→2 de CO autoperturbe et perturbe par N₂, O₂, H₂, HCl, NO, et CO₂," *J. Quant. Spectrosc. Radiat. Transfer* **13**, 1-7 (1973) SB,FB,PS.
- [5.269] G. Guelachvili, "New near infrared wavenumber standards (2←0 band of ¹²C¹⁶O) by high resolution Fourier spectroscopy in vacuum," *Opt. Commun.* **8**, 171-175 (1973) W.
- [5.270] J.-P. Bouanich and C. Brodbeck, "Etalonnage et déplacement des raies de vibration-rotation des bands 0→2 et 0→3 de l'oxyde de carbone," *Rev. Phys. Appl.* **9**, 475-478 (1974) PS.
- [5.271] J.-P. Bouanich and C. Brodbeck, "Moments de transition vibrationnelle des molecules diatomiques. Intensite des raies rovibrationnelles des bandes 0→2 et 0→3 et fonction dipolaire de CO," *J. Quant. Spectrosc. Radiat. Transfer* **14**, 1199-1208 (1974) I,T.
- [5.272] A. W. Mantz and J.-P. Maillard, "Emission spectra with a high resolution Fourier transform spectrometer: CO spectra and their astrophysical importance," *J. Mol. Spectrosc.* **53**, 466-478 (1974) W.
- [5.273] M. Crance and J. Verges, "Measurements of line strengths in the 2-0 band of CO," *J. Phys. B* **8**, 3001-3006 (1975) I.
- [5.274] A. W. Mantz, J.-P. Maillard, W. B. Roh, and K. Narahari Rao, "Ground state molecular constants of ¹²C¹⁶O," *J. Mol. Spectrosc.* **57**, 155-159 (1975) W.
- [5.275] K. Tanabe, "Infrared intensity measurement of gas phase molecules," *J. Mol. Struct.* **29**, 319-327 (1975) I.
- [5.276] N. I. Moskalenko, "Measurement of intensities and half-widths of spectral absorption lines of the fundamental 0-1 band of CO," *Opt. Spectrosc. (USSR)* **38**, 382-384 (1975) I,SB,FB.
- [5.277] P. Varanasi and S. Sarangi, "Measurements of intensities and nitrogen-broadened linewidths in the CO fundamental at low temperature," *J. Quant. Spectrosc. Radiat. Transfer* **15**, 473-482 (1975) I,FB.
- [5.278] R. B. Nerf and M. A. Sonnenberg, "Pressure broadening of the J=1←0 transition of carbon monoxide," *J. Mol. Spectrosc.* **58**, 474-478 (1975) SB,FB,PS.
- [5.279] J. W. Fleming, "Line strength and halfwidth measurements from far infrared absorption spectra: carbon monoxide," *J. Quant. Spectrosc. Radiat. Transfer* **16**, 63-68 (1976) SB,I.
- [5.280] J. P. Bouanich and C. Brodbeck, "Vibration-rotation matrix elements for diatomic molecules; vibration-rotation interaction functions $F_v''(m)$ for CO," *J. Quant. Spectrosc. Radiat. Transfer* **16**, 153-163 (1976) I,T.

- [5.281] J. Bonamy and D. Robert, "Atom-atom potential in rotational line broadening for molecular gases: application to CO lines broadened by CO, N₂, O₂, and NO," *J. Quant. Spectrosc. Radiat. Transfer* **16**, 185-190 (1976) FB,SB,T.
- [5.282] R. H. Tipping, "Vibration-rotation intensities for "Hot" bands," *J. Mol. Spectrosc.* **61**, 272-281 (1976) I,T.
- [5.283] J. P. Bouanich, "High order vibrational matrix elements for diatomic molecules; dipole moment function and transition moments of CO," *J. Quant. Spectrosc. Radiat. Transfer.* **16**, 1119-1131 (1976) T,I.
- [5.284] T. R. Todd, C. M. Clayton, W. B. Telfair, T. K. McCubbin, and J. Pliva, "Infrared emission of ¹²C¹⁶O, ¹³C¹⁶O, and ¹²C¹⁸O," *J. Mol. Spectrosc.* **62**, 201-227 (1976) W.
- [5.285] G. Guelachvili, "Atomic Masses and Fundamental Constants," (J. H. Sanders and A. H. Wapstra, Eds.), Vol. 5, pp 424-430, Plenum Press, New York, 1976 W.
- [5.286] W. L. Meerts, F. H. DeLeeuw, and A. Dymanus, "Electric and magnetic properties of carbon monoxide by molecular-beam electric-resonance spectroscopy," *Chem. Phys.* **22**, 319-324 (1977) F.
- [5.287] J. P. Bouanich, "Fourth-order contributions to the rotational-vibrational matrix elements for diatomic molecules; application to the F_v'(m) functions for CO," *J. Quant. Spectrosc. Radiat. Transfer* **17**, 639-650 (1977) T,I.
- [5.288] T. A. Dixon, Ph.D. thesis, University of Wisconsin, 1977 F.
- [5.289] G. Guelachvili, "Absolute wavenumbers and molecular constants of the fundamental bands of ¹²C¹⁶O, ¹²C¹⁷O, ¹²C¹⁸O, ¹³C¹⁶O, ¹³C¹⁷O, ¹³C¹⁸O and of the 2-1 bands of ¹²C¹⁶O and ¹³C¹⁶O, around 5μm, by Fourier spectroscopy under vacuum," *J. Mol. Spectrosc.* **75**, 251-269 (1979) W.
- [5.290] P. L. Varghese and R. K. Hanson, "Tunable infrared diode laser measurements of line strengths and collision widths of ¹²C¹⁶O at room temperature," *J. Quant Spectrosc. Radiat. Transfer* **24**, 479-489 (1980) I,FB.
- [5.291] J. Mink, A. Ayoub, G. Kemeny, and F. Kling, "The 1-0 band and rotational-vibrational constants of ¹⁴C-labeled carbon monoxide," *J. Mol. Spectrosc.* **86**, 258-261 (1981) W.
- [5.292] J.-P. Bouanich, Nguyen-Van-Thanh, and H. Strapelias, "Intensity, bandshapes and dipole correlation functions for the first overtone of compressed CO," *J. Quant. Spectrosc. Radiat. Transfer* **26**, 53-63 (1981) I,SB.
- [5.293] J. N-P. Sun and P. R. Griffiths, "Temperature dependence of the self-broadening coefficients for the fundamental band of carbon monoxide," *Appl. Opt.* **20**, 1691-1695 (1981) SB.
- [5.294] G. Guelachvili, "Differential Fourier spectroscopy with simultaneous interferograms: application to extensive accurate pressure-shift measurements," *Appl. Opt.* **20**, 2121-2132 (1981) PS.
- [5.295] G. Chandraiah and G. R. Hebert, "Absorption intensity measurements of the first overtone band of CO," *Can. J. Phys.* **59**, 1367-1372 (1981) I.
- [5.296] J. J. BelBruno, J. Gelfand, W. Radigan, and K. Verges, "Helium and self-broadening in the first and second overtone bands of ¹²C¹⁶O," *J. Mol. Spectrosc.* **94**, 336-342 (1982) SB,FB.
- [5.297] H. S. Lowry and C. J. Fisher, "Line parameter measurements and calculations of CO broadened by nitrogen at elevated temperatures," *J. Quant. Spectrosc. Radiat. Transfer* **27**, 585-591 (1982) I,FB.
- [5.298] T. Nakazawa and M Tanaka, "Measurements of intensities and self- and foreign-gas-broadened half-widths of spectral lines in the CO fundamental band," *J. Quant. Spectrosc. Radiat. Transfer* **28**, 409-416 (1982) I,SB,FB.
- [5.299] T. Nakazawa and M. Tanaka, "Intensities, Half-widths and Shapes of Spectral Lines in the Fundamental Band of CO at Low Temperatures," *J. Quant. Spectrosc. Radiat. Transfer* **28**, 471-480 (1982) I,SB,FB.

- [5.300] C. Chackerian, G. Guelachvili, and R. H. Tipping, "CO 1-0 band isotopic lines as intensity standards," *J. Quant. Spectrosc. Radiat. Transfer* **30**, 107-112 (1983) I,T.
- [5.301] G. Guelachvili, D. de Villeneuve, R. Farrenq, W. Urban, and J. Verges, "Dunham coefficients for seven isotopic species of CO," *J. Mol. Spectrosc.* **98**, 64-79 (1983) W.
- [5.302] J.-P. Bouanich, "Lineshifts in the first overtone band of CO self-perturbed and perturbed by N₂ at 298, 193, and 133 K," *Can. J. Phys.* **61**, 919-921 (1983) PS,T.
- [5.303] K. Kim, "The integrated intensity of the carbon monoxide fundamental band," *J. Quant. Spectrosc. Radiat. Transfer* **30**, 413-416 (1983) I.
- [5.304] C. R. Pollock, F. R. Petersen, D. A. Jennings, J. S. Wells, and A. G. Maki, "Absolute frequency measurements of the 2-0 band of CO at 2.3 μm ; calibration standard frequencies from high resolution color center laser spectroscopy," *J. Mol. Spectrosc.* **99**, 357-368 (1983) F,PS.
- [5.305] C. Chackerian and R. H. Tipping, "Vibration-rotational and rotational intensities for CO isotopes," *J. Mol. Spectrosc.* **99**, 431-449 (1983) T.
- [5.306] L. R. Brown and R. A. Toth, "Comparison of the frequencies of NH₃, CO₂, H₂O, N₂O, CO, and CH₄ as infrared calibration standards," *J. Opt. Soc. Am. B* **2**, 842-856 (1985) W.
- [5.307] G. Guelachvili and K. Narahari Rao, "*Handbook of Infrared Standards*," Academic Press, San Diego, 1986 W.
- [5.308] J. M. Hartmann, M. Y. Perrin, J. Taine, and L. Rosenmann, "Diode-laser measurements and calculations of CO 1-0 P(4) line broadening in the 294- to 765-K temperature range," *J. Quant. Spectrosc. Radiat. Transfer* **35**, 357-363 (1986) I,FB.
- [5.309] I. G. Nolt, J. V. Radostitz, G. DiLonardo, K. M. Evenson, D. A. Jennings, K. R. Leopold, M. D. Vanek, L. R. Zink, A. Hinz, and K. V. Chance, "Accurate rotational constants of CO, HCl, and HF: spectral standards for the 0.3- to 6-THz (10- to 200-cm⁻¹) region," *J. Mol. Spectrosc.* **125**, 274-287 (1987) F.
- [5.310] J.-P. Bouanich, "Vibration-rotation matrix elements for infrared transitions of diatomic molecules," *J. Quant. Spectrosc. Radiat. Transfer* **37**, 17-46 (1987) I.
- [5.311] N. Semmoud-Monnanteuil and J. M. Colmont, "Pressure broadening of millimeter lines of carbon monoxide," *J. Mol. Spectrosc.* **126**, 210-219 (1987) SB,FB.
- [5.312] J.-P. Bouanich and G. Blanquet, "Pressure broadening of CO and OCS spectral lines," *J. Quant. Spectrosc. Radiat. Transfer* **40**, 205-220 (1988) T,SB,FB.
- [5.313] M. Schneider, K. M. Evenson, M. D. Vanek, D. A. Jennings, J. S. Wells, A. Stahn, and W. Urban, "Heterodyne frequency measurements of ¹²C¹⁶O laser transitions," *J. Mol. Spectrosc.* **135**, 197-206 (1989) F.
- [5.314] M. Schneider, J. S. Wells, and A. G. Maki, "Heterodyne frequency measurements of ¹²C¹⁶O laser transitions near 2050 cm⁻¹," *J. Mol. Spectrosc.* **139**, 432-438 (1990), and **141**, 351 (1990) F.
- [5.315] L. R. Zink, P. De Natale, F. S. Pavone, M. Prevedelli, K. M. Evenson, and M. Inguscio, "Rotational far infrared spectrum of ¹³CO," *J. Mol. Spectrosc.* **143**, 304-310 (1990) F,W.
- [5.316] A. G. Maki, J. S. Wells, and D. A. Jennings, "Heterodyne frequency measurements on CO and OCS beyond 2100 cm⁻¹," *J. Mol. Spectrosc.* **144**, 224-229 (1990) F.
- [5.317] A. LeFloch, "Revised molecular constants for the ground state of CO," *Mol. Phys.* **72**, 133-144 (1991) T.
- [5.318] D. Bailly, C. Rossetti, F. Thibault, and R. Le Doucen, "¹²C¹⁶O: Experimental determination of the linear coefficient of the Herman-Wallis factor," *J. Mol. Spectrosc.* **148**, 329-337 (1991) I.
- [5.319] R. Farrenq, G. Guelachvili, A. J. Sauval, N. Grevesse, and C. B. Farmer, "Improved Dunham coefficients for CO from infrared solar lines of high rotational excitation," *J. Mol. Spectrosc.* **149**, 375-390 (1991) W.

- [5.320] T. D. Varberg and K. M. Evenson, "Accurate far-infrared rotational frequencies of carbon monoxide," *Astrophys. J.* (in press) F.
- [5.321] T. George, B. Wu, A. Dax, M. Schneider, and W. Urban, "Saturation stabilization of the CO fundamental band laser," *Appl. Phys. B* (in press) F.

NO

- [5.322] K. Narahari Rao, R. V. deVore, and E. K. Plyler, "Wavelength calibrations in the far infrared (30 to 1000 microns)," *J. Res. NBS* **67A**, 351-358 (1963) W.
- [5.323] T. C. James, "Intensity of the forbidden $X^2\Pi_{3/2}$ - $X^2\Pi_{1/2}$ satellite bands in the infrared spectrum of nitric oxide," *J. Chem. Phys.* **40**, 762-771 (1964) I,T,SB.
- [5.324] T. C. James and R. J. Thibault, "Spin-orbit coupling constant of nitric oxide. Determination from fundamental and satellite band origins," *J. Chem. Phys.* **41**, 2806-2813 (1964) W.
- [5.325] R. L. Brown and H. E. Radford, "L-uncoupling effects on the electron-paramagnetic-resonance spectra of $N^{14}O^{16}$ and $N^{15}O^{16}$," *Phys. Rev.* **147**, 6-12 (1966) F.
- [5.326] L. L. Abels and J. H. Shaw, "Widths and strengths of vibration-rotation lines in the fundamental band of nitric oxide," *J. Mol. Spectrosc.* **20**, 11-28 (1966) I,SB.
- [5.327] C. Alamichel, "Etude de la dispersion dans la bande fondamentale de vibration-rotation de NO," *J. Phys. (Paris)* **27**, 345-352 (1966) I.
- [5.328] R. M. Neumann, "High-precision radiofrequency spectrum of $^{14}N^{16}O$," *Astrophys. J.* **161**, 779-784 (1970) F.
- [5.329] J. M. Brown, A. R. H. Cole, and F. R. Honey, "Magnetic dipole transitions in the far infrared spectrum of nitric oxide," *Mol. Phys.* **23**, 287-295 (1972) I,W.
- [5.330] W. T. King and B. Crawford, Jr., "The integrated intensity of the nitric oxide fundamental band," *J. Quant. Spectrosc. Radiat. Transfer* **12**, 443-447 (1972) I.
- [5.331] G. Chandraiah and C. W. Cho, "A study of the fundamental and first overtone bands of NO in NO-rare gas mixtures at pressures up to 10,000 psi," *J. Mol. Spectrosc.* **47**, 134-147 (1973) I.
- [5.332] K. Hakuta and H. Uehara, "Laser magnetic resonance for the $v=1\leftarrow 0$ transition of NO ($^2\Pi_{3/2}$) by CO laser," *J. Mol. Spectrosc.* **58**, 316-322 (1975) LS.
- [5.333] A. Goldman and S. C. Schmidt, "Infrared spectral line parameters and absorptance calculations of NO at atmospheric and elevated temperatures for the $\Delta v=1$ bands region," *J. Quant. Spectrosc. Radiat. Transfer* **15**, 127-138 (1975) T.
- [5.334] A. R. Hoy, J. W. C. Johns, and A. R. W. McKellar, "Stark spectroscopy with the CO laser: dipole moments, hyperfine structure, and level crossing effects in the fundamental band of NO," *Can. J. Phys.* **53**, 2029-2039 (1975) LS.
- [5.335] R. J. Butcher, R. B. Dennis, and S. D. Smith, "The tunable spin-flip Raman laser II. Continuous wave molecular spectroscopy," *Proc. Roy. Soc. (London) A* **344**, 541-561 (1975) W.
- [5.336] W. L. Meerts, "A theoretical reinvestigation of the rotational and hyperfine lambda doubling spectra of diatomic molecules with a $^2\Pi$ state: the spectrum of NO," *Chem. Phys.* **14**, 421-425 (1976) F,T.
- [5.337] R. E. Richton, "NO line parameters measured by CO laser transmittance," *Appl. Opt.* **15**, 1686-1687 (1976) FB,SB.
- [5.338] R. K. Hanson, J. P. Monat, and C. H. Kruger, "Absorption of CO laser radiation by NO," *J. Quant. Spectrosc. Radiat. Transfer* **16**, 705-713 (1976) I,SB,F.
- [5.339] G. D. T. Tejwani, B. M. Golden, and E. S. Yeung, "Pressure-broadened linewidths of nitric oxide," *J. Chem. Phys.* **65**, 5110-5114 (1976) FB,SB,T.
- [5.340] P. Rabache, "Far infrared spectral lines and absorptance calculation of NO," *J. Quant. Spectrosc. Radiat. Transfer* **17**, 673-678 (1977) I,W.

- [5.341] J. W. C. Johns, J. Reid, and D. W. Leppard, "The vibration-rotation fundamental of NO," *J. Mol. Spectrosc.* **65**, 155-162 (1977) W.
- [5.342] M. A. Guerra, A. Sanchez, and A. Javan, " $\nu=2\leftarrow 1$ absorption spectroscopy of vibrationally heated NO molecules using optical pumping in a wave guide," *Phys. Rev. Lett.* **38**, 482-484 (1977) F.
- [5.343] R. M. Dale, J. W. C. Johns, A. R. W. McKellar, and M. Rigglin, "High-resolution laser magnetic resonance and infrared-radiofrequency double-resonance spectroscopy of NO and its isotopes near $5.4\ \mu\text{m}$," *J. Mol. Spectrosc.* **67**, 440-458 (1977) LS.
- [5.344] B. K. Garside, E. A. Ballik, M. Elsherbiny, and J. Shewchun, "Resonance absorption measurements of NO with a line-tunable CO laser: spectroscopic data for pollution monitoring," *Appl. Opt.* **16**, 398-402 (1977) I,SB.
- [5.345] A. Valentin, A. Henry, Ph. Cardinet, M. F. Le Moal, Da-Wun Chen, and K. Narahari Rao, "Measurement and interpretation of the 1-0 band of $^{14}\text{N}^{16}\text{O}$ at $1900\ \text{cm}^{-1}$," *J. Mol. Spectrosc.* **70**, 9-17 (1978) W.
- [5.346] A. Henry, M. F. Le Moal, Ph. Cardinet, and A. Valentin, "Overtone bands of $^{14}\text{N}^{16}\text{O}$ and determination of molecular constants," *J. Mol. Spectrosc.* **70**, 18-26 (1978) W.
- [5.347] K. Kunitani, H. Horiguchi, and S. Tsuchiya, "Intensity and line-width measurements of the NO fundamental by infrared molecular absorption spectrometry," *J. Quant. Spectrosc. Radiat. Transfer* **19**, 127-133 (1978) I,FB.
- [5.348] L. D. G. Young, A. T. Young, S. A. Clough, and F. X. Kneizys, "Calculation of spectroscopic data for the $\nu=0$ and $\nu=1$ states of nitric oxide," *J. Quant. Spectrosc. Radiat. Transfer* **20**, 317-325 (1978) I,W.
- [5.349] R. E. Richton, "Pressure-broadening linewidths of the $R(9.5)_{3/2}$ NO transitions," *Appl. Opt.* **17**, 1606-1609 (1978) SB.
- [5.350] C. Amiot, R. Bacis, and G. Guelachvili, "Infrared study of the $X^2\Pi\ \nu=0,1,2$ levels of $^{14}\text{N}^{16}\text{O}$. Preliminary results on the $\nu=0,1$ levels of $^{14}\text{N}^{17}\text{O}$, $^{14}\text{N}^{18}\text{O}$, and $^{15}\text{N}^{16}\text{O}$," *Can. J. Phys.* **56**, 251-265 (1978) W.
- [5.351] L. A. Farrow and R. E. Richton, "Extinction coefficient of the $R_{\nu_2}(25/2)$ NO transition at the 8-7 P(11) CO laser line," *Appl. Opt.* **18**, 597-599 (1979) I,SB.
- [5.352] A. S. Pine and K. W. Nill, "Molecular-beam tunable-diode-laser sub-Doppler spectroscopy of Λ -doubling in nitric oxide," *J. Mol. Spectrosc.* **74**, 43-51 (1979) W.
- [5.353] A. S. Pine, J. W. C. Johns, and A. G. Robiette, " Λ -doubling in the $\nu=2\leftarrow 0$ overtone band in the infrared spectrum of NO," *J. Mol. Spectrosc.* **74**, 52-69 (1979) W.
- [5.354] L. D. G. Young and A. T. Young, "Calculation of spectroscopic data for the $\nu=2$ and $\nu=3$ states of nitric oxide," *J. Quant. Spectrosc. Radiat. Transfer* **21**, 227-231 (1979) W,I.
- [5.355] C. Amiot and G. Guelachvili, "Infrared study of the ^{15}N isotopic species of nitric oxide near $5.4\ \mu\text{m}$," *J. Mol. Spectrosc.* **76**, 86-103 (1979) W.
- [5.356] C. Amiot and J. Verges, "The $^{14}\text{N}^{16}\text{O}$ ground state up to $\nu=15$ by emission Fourier transform spectroscopy of the $\Delta\nu=2$ sequence," *J. Mol. Spectrosc.* **81**, 424-444 (1980) W.
- [5.357] W. L. Meerts and L. Veseth, "The Zeeman spectrum of the NO molecule," *J. Mol. Spectrosc.* **82**, 202-213 (1980) F.
- [5.358] J. L. Teffo, A. Henry, Ph. Cardinet, and A. Valentin, "Determination of molecular constants of nitric oxide from (1-0), (2-0), (3-0) bands of the $^{15}\text{N}^{16}\text{O}$ and $^{15}\text{N}^{18}\text{O}$ isotopic species," *J. Mol. Spectrosc.* **82**, 348-363 (1980) W.
- [5.359] J.-Y. Mandin, C. Amiot, and G. Guelachvili, "Intensity and self-broadening coefficient measurements from Fourier transform spectra: application to the nitric oxide fundamental band," *Ann. Phys. (Paris)* **5**, 91-111 (1980) I,SB.
- [5.360] R. Freedman and R. W. Nicholls, "Molecular constants for the $\nu=0,1$ ($A^2\Sigma^+$) levels of the NO molecule and its isotopes," *J. Mol. Spectrosc.* **83**, 223-227 (1980) W.

- [5.361] W. Rohrbeck, R. Winter, W. Herrmann, J. Wildt, and W. Urban, "Pressure broadening coefficients for nitric oxide, measured with a spin-flip Raman-laser spectrometer," *Mol. Phys.* **39**, 673-681 (1980) FB,SB.
- [5.362] F. C. van den Heuvel, W. L. Meerts, and A. Dymanus, "High-resolution tunable spectroscopy of rotational transitions of NO near 30 cm^{-1} ," *J. Mol. Spectrosc.* **84**, 162-169 (1980) F.
- [5.363] R. S. Lowe, A. R. W. McKellar, P. Veillette, and W. L. Meerts, "Hyperfine and Λ -doubling parameters for the $v=1$ state of NO from infrared-radiofrequency double resonance," *J. Mol. Spectrosc.* **88**, 372-377 (1981) F,W.
- [5.364] J. A. Sell, "Infrared diode laser spectroscopy of nitric oxide," *J. Quant. Spectrosc. Radiat. Transfer* **25**, 19-24 (1981) I,FB.
- [5.365] J. R. Gillis and A. Goldman, "Nitric oxide IR line parameters for the upper atmosphere," *Appl. Opt.* **21**, 1161-1163 (1982) I.
- [5.366] C. Amiot, "The infrared emission spectrum of NO: analysis of the $\Delta v=3$ sequence up to $v=22$," *J. Mol. Spectrosc.* **94**, 150-172 (1982) W.
- [5.367] P. K. Falcone, R. K. Hanson, and C. H. Kruger, "Tunable diode laser measurements of the band strength and collision halfwidths of nitric oxide," *J. Quant. Spectrosc. Radiat. Transfer* **29**, 205-221 (1983) I,FB.
- [5.368] R. F. Holland, M. C. Vasquez, W. H. Beattie, and R. S. McDowell, "Absorptivity of nitric oxide in the fundamental vibrational band," *J. Quant. Spectrosc. Radiat. Transfer* **29**, 435-438 (1983) I.
- [5.369] W. Lempert, G. J. Rosasco, and W. S. Hurst, "Rotational collisional narrowing in the NO fundamental Q branch studied with cw stimulated Raman spectroscopy," *J. Chem. Phys.* **81**, 4241-4245 (1984) I,SB.
- [5.370] A. S. Pine, A. G. Maki, and N.-Y. Chou, "Pressure broadening, lineshapes, and intensity measurements in the $2\leftarrow 0$ band of NO," *J. Mol. Spectrosc.* **114**, 132-147 (1985) I,SB,FB,PS.
- [5.371] A. Hinz, J. S. Wells, and A. G. Maki, "Heterodyne frequency measurements on the nitric oxide fundamental band," *J. Mol. Spectrosc.* **119**, 120-125 (1986) F.
- [5.372] W. J. Phillips and H. C. Walker, "Nitrogen-broadened linewidths and strengths of nitric oxide utilizing tunable diode laser spectroscopy," *J. Chem. Phys.* **85**, 3213-3216 (1986) I,FB.
- [5.373] T. G. Neiss, R. W. Lovejoy, and C. Chackerian, Jr. "Pressure broadening coefficients of $^{14}\text{N}^{16}\text{O}-\text{N}_2$ gas mixtures," *J. Mol. Spectrosc.* **124**, 229-235 (1987) I,FB.
- [5.374] J. Ballard, W. B. Johnston, B. J. Kerridge, and J. J. Remedios, "Experimental spectral line parameters in the 1-0 band of Nitric oxide," *J. Mol. Spectrosc.* **127**, 70-82 (1988) I,SB,FB.

CS₂

- [5.375] D. Z. Robinson, "The experimental determination of the intensities of infrared absorption bands. IV. Measurements of the stretching vibrations of OCS and CS₂," *J. Chem. Phys.* **19**, 881-886 (1951) I.
- [5.376] H. J. Callomon, D. C. McKean, and H. W. Thompson, "Intensities of vibration bands. IV. Carbonyl sulphide and acetylene," *Proc. Roy. Soc. (London) A* **208**, 341-351 (1951) I.
- [5.377] R. Kiyama and K. Ozawa, *Rev. Phys. Chem. Japan* **25**, 38 (1955) I.
- [5.378] D. C. McKean, H. J. Callomon, and H. W. Thompson, "Intensities of vibration bands of carbonyl sulfide and carbon disulfide," *J. Chem. Phys.* **20**, 520 (1951) I.
- [5.379] W. B. Person and L. C. Hall, "Absolute infrared intensities of CS₂ fundamentals in gas and liquid phases. An interpretation of the bond moments of CO₂ and CS₂," *Spectrochimica Acta* **20**, 771-779 (1964) I.
- [5.380] H. Yamada and W. B. Person, "Absolute infrared intensities of some linear triatomic molecules in the gas phase," *J. Chem. Phys.* **45**, 1861-1865 (1966) I.

- [5.381] D. F. Smith, T. Chao, J. Lin, and J. Overend, "High resolution of $^{12}\text{CS}_2$ and $^{13}\text{CS}_2$ and the $\nu_3-\nu_1$, $\nu_3-2\nu_2$ and $\nu_3+4\nu_2$ bands," *Spectrochim. Acta A* **27**, 1979-1987 (1970) W.
- [5.382] K. Jolma and J. Kauppinen, "High-resolution infrared spectrum of CS_2 in the region of the bending fundamental ν_2 ," *J. Mol. Spectrosc.* **82**, 214-219 (1980) W.
- [5.383] G. Blanquet, J. Walrand, and C. P. Courtoy, "La bande ν_3 du disulfure de carbone $^{12}\text{C}^{34}\text{S}_2$ et $^{13}\text{C}^{34}\text{S}_2$," *Ann. Soc. Scient. Bruxelles* **94**, 129-139 (1980) W.
- [5.384] E. Baeten, G. Blanquet, J. Walrand, and C. P. Courtoy, "Spectres infrarouges a haute resolution du disulfure de carbone $^{12}\text{C}^{32}\text{S}_2$ et $^{12}\text{C}^{34}\text{S}_2$ la bande $\nu_3-\nu_1$," *Ann. Soc. Scient. Bruxelles* **97**, 229-241 (1984) W.
- [5.385] E. Baeten, G. Blanquet, J. Walrand, and C. P. Courtoy, "Tunable diode laser spectra of the $\nu_3-\nu_1$ region of CS_2 ," *Can. J. Phys.* **62**, 1286-1292 (1984) W.
- [5.386] J. Lindenmayer and H. Jones, "Diode laser spectroscopy of the ν_3 band region of four isotopic forms of CS_2 ," *J. Mol. Spectrosc.* **110**, 65-73 (1985) W.
- [5.387] G. Blanquet, E. Baeten, I. Cauuet, J. Walrand, and C. P. Courtoy, "Diode-laser Measurements of carbon disulfide and general rovibrational analysis," *J. Mol. Spectrosc.* **112**, 55-70 (1985) W.
- [5.388] M. Dang-Nhu, G. Blanquet, J. Walrand, and C. P. Courtoy, "Spectral intensities in the $\nu_3-\nu_1$ band of CS_2 ," *Mol. Phys.* **58**, 995-1000 (1986) I.
- [5.389] F. Winther, U. Heyne, and A. Guarnieri, "The infrared spectrum of CS_2 in the ν_3 band region," *Z. Naturforsch.* **43a**, 215-218 (1988) W.
- [5.390] J. S. Wells, M. Schneider, and A. G. Maki, "Calibration tables covering the 1460-1550- cm^{-1} region from heterodyne frequency measurements on the ν_3 bands of $^{12}\text{CS}_2$ and $^{13}\text{CS}_2$," *J. Mol. Spectrosc.* **132**, 422-428 (1988) F.

CHAPTER VI

ATLAS AND WAVENUMBER TABLES

Description

Throughout the wavenumber tables the lines that are suitable for use as wavenumber standards are indicated by an asterisk (*) following the wavenumber and its uncertainty. In assigning the asterisks no consideration was given to problems related to overlapping with other transitions. The tables list nearby lines that may cause problems with overlapping. The user must exercise judgment in determining if such overlapping will impair the accuracy of the measurement. The asterisk only certifies the accuracy of the line position in the hypothetical absence of any other nearby lines. Obviously, the resolution of the instrumentation being used will determine if a nearby line might invalidate the accuracy of a calibration line.

The uncertainties of the wavenumbers are given in parentheses after the wavenumbers in those cases where there is reason to believe that a good estimate of the uncertainty can be made. Even so, the uncertainty in the lines not designated as calibration lines should be taken with some degree of skepticism.

The uncertainties given in the tables are twice the estimated standard error as calculated from the variance-covariance matrix given by the least-squares fit that determined the constants used to calculate the wavenumbers. The uncertainties refer to the accuracy of each individual transition. In general, the wavenumber separation of two nearby lines for the same vibrational transition of the same molecular species will be given more accurately than the uncertainty given in parentheses might lead one to believe. That is because the relative differences between the rotational energy levels are usually known more accurately than the differences in the vibrational energy levels.

On the other hand, the separation of two lines that are due to absorption from two different isotopic species is probably known no more accurately than the uncertainty (given in parentheses) would lead us to believe.

The wavenumbers given in the tables are calculated wavenumbers because they are more reliable than individual line measurements and the uncertainties in the calculated wavenumbers can be accurately estimated.

The wavenumber tables also contain a column for the intensity estimated for each transition at a temperature of 296 K. The format for the intensity values is the standard computer format consisting of a decimal value followed by the exponent (the power of ten multiplying the decimal value). The intensities given in the wavenumber tables are represented by S in Eq. (3.10) and are integrated line intensities rather than peak intensities.

In the sections giving discussions and equations on intensity calculations and on pressure broadening (Chapter III), equations are given for estimating the appearance of the spectrum for different experimental conditions. In particular, Eq. (3.37) can be used to estimate the percent transmission at the center of a line under different conditions of pressure and pathlength. As an aid in calculating intensities at different temperatures the tables for OCS and N₂O also contain a column giving the separation (in cm⁻¹) of the lower state energy level from the ground state. The units given in the tables can be converted to the more common units of cm⁻² atm⁻¹ at 296 K by multiplying by 2.479×10^{19} . To convert to intensities at some other temperature one should refer to Eq. (3.10). Smith *et al.* [5.2] give a table for converting to other units.

The intensity values given in this book are only given as an aid in estimating the appearance of the spectrum, they should not be treated as well determined values. The intensities given for weak lines and especially for the rarer isotopes may be in error by 50 percent or more.

The spectral illustrations were actually calculated spectra rather than reproductions of real measurements. This gave us more flexibility in choosing effective pressures and pathlengths that seemed most appropriate to illustrate even the weak lines. As with any digitized spectrum, regardless of whether it is calculated or measured, the peak intensity of sharp lines may show some irregularity depending on whether the true peak falls on a digitized point or slightly misses it. The spectra were plotted with a digitizing interval of about 0.0005 to 0.001 cm^{-1} . Close doublets that should have the same intensity may show slight intensity differences because of this digitizing effect.

Comparison with real spectra measured in our own laboratory or illustrated in published works (such as Refs. [5.101, 5.102, 5.307]) showed that the spectra given in this book are adequate for identifying the calibration lines. Some weak transitions may be absent from the calculated spectrum even though they might be found in a real spectrum of comparable pressure and pathlength. Certainly, absorption due to common impurities such as H_2O or CO_2 will not be found in these spectra.

The spectra used in the illustrations for CO were calculated for infinite resolution but the lines were given widths dictated by the Doppler width of the line convolved with the pressure broadened width. For the CO spectra the shape of the weak lines is dominated by the Doppler width which is 0.0047 cm^{-1} (FWHM) at 2000 cm^{-1} and 0.0093 cm^{-1} at 4000 cm^{-1} . For the conditions chosen for the atlas illustrations, the strong CO lines are much broader than the weak ones and show pronounced shoulders due to the effect of even a very small pressure broadening.

The figures used for illustrating the OCS and N_2O spectra were calculated for spectrometer resolutions on the order of 0.003 cm^{-1} . Again the expected Doppler and pressure-broadened lineshapes were used in calculating the spectra. The atlas for OCS and N_2O is divided into sections according to the vibrational transitions involved. At the beginning of each section the parameters (slit width, dipole derivative, Herman-Wallis constants) used in calculating the spectra are given as well as a key to the abbreviations used for the vibrational transitions in the atlas.

In calculating the pressure-broadened width, a single value for the pressure broadening was used for all lines in a spectrum. It is well known that such an assumption is incorrect and therein lies one reason for the illustration to depart slightly from a true spectrum.

The spectra overlap slightly in order to show the relationship of the lines near the ends of each panel. At the top of each spectrum fiducial marks indicate which lines are given in the accompanying wavenumber tables. Every fifth line is indicated with a darker and longer mark. In the tables, every fifth line is set apart by a following blank line. Even though the panels overlap, each line is identified by a fiducial mark only once.

Diskettes with Detailed Linelist

In preparing the tables for this atlas, far more transitions were calculated than could possibly be published. A complete list of transitions calculated for this work is available from the authors in the form of four floppy diskettes readable on a personal computer (PC) capable of reading 5¼ inch high-density floppy discs generated by DOS-5.0. These diskettes are written in ASCII and contain the following information: wavenumber (cm^{-1}), uncertainty, lower state energy (cm^{-1}), intensity ($\text{cm}/\text{molecule}$), vibrational assignment, rotational assignment, date of data entry, isotopic species, and band designation according to the keys given in this book. The authors intend to update these discs as new data become available. Persons interested in obtaining the most up-to-date calibration data should contact the authors for the most recent version of these discs.

ATLAS of CO ABSORPTION LINES

from 1948 to 2275 cm^{-1}

and

from 4071 to 4352 cm^{-1}

Spectra of the fundamental region are given for a slitwidth of $< 0.001 \text{ cm}^{-1}$ and a transition moment of 0.1073 debye at a temperature of 296 K. For the first overtone region the transition moment was 0.0066 debye and the same narrow slitwidth was used. No Herman-Wallis constant was used for the fundamental band but the constants $C_1 = 0.005$ and $C_2 = 0.000\ 034$ were used for the first overtone band region.

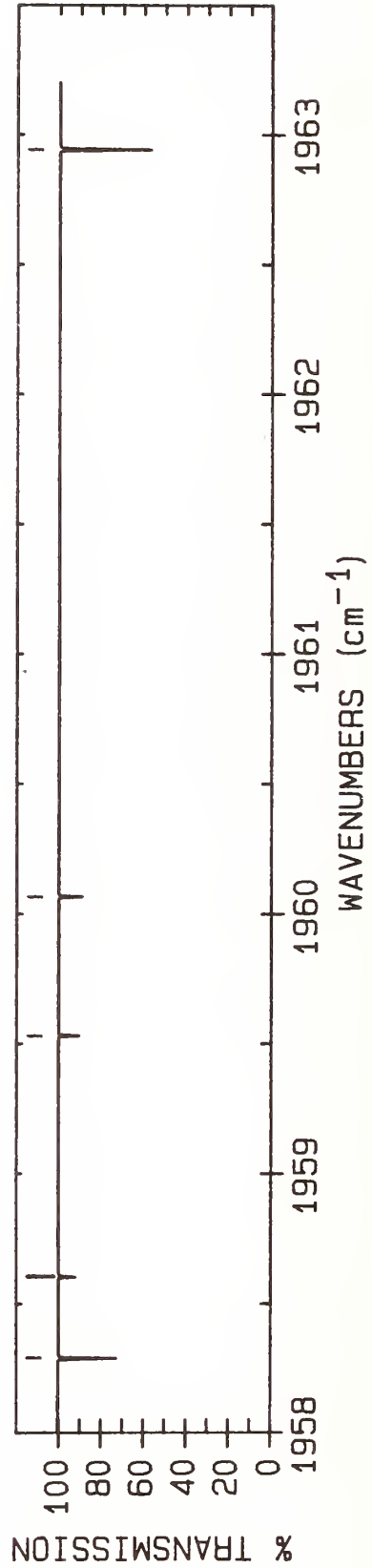
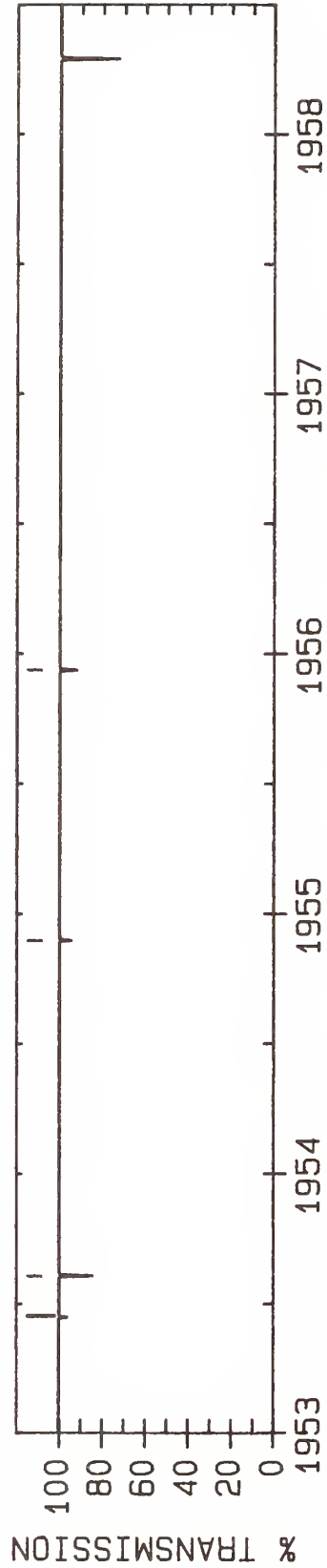
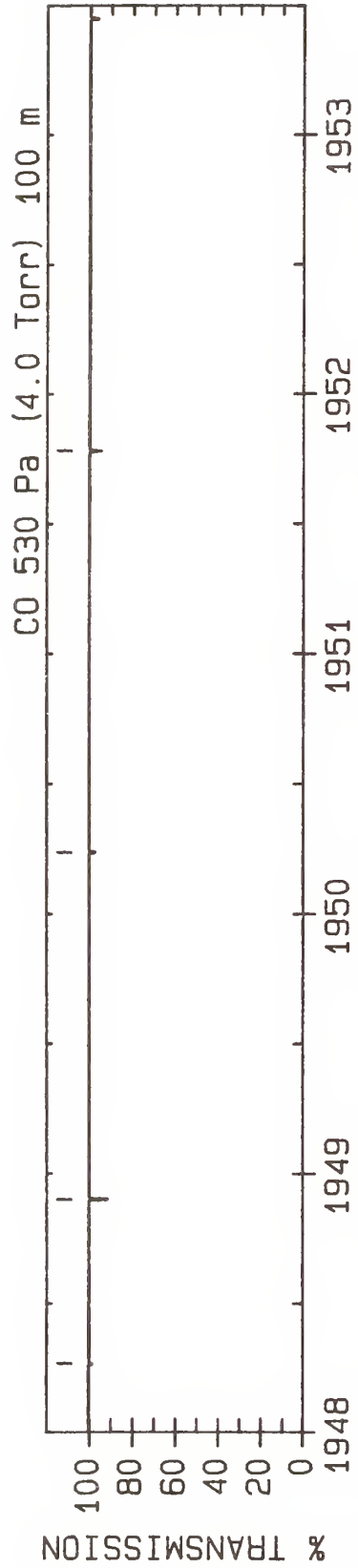

LINE #	WAVENUMBER(unc) (cm^{-1})	ROTATIONAL ASSIGNMENT	Mol.	INTENSITY ($\text{cm}^2/\text{molecule}$)
1	1948.266 18(8)*	P(43)	1	0.860E-25
2	1948.900 4	P(35)	2	0.424E-24
3	1950.237 1	P(34)	3	0.145E-24
4	1951.781 3	P(24)	5	0.253E-24
5	1953.449 28(7)*	P(42)	1	0.186E-24
6	1953.609 0	P(34)	2	0.768E-24
7	1954.898 0	P(33)	3	0.258E-24
8	1955.937 5	P(23)	5	0.365E-24
9	1958.289 5	P(33)	2	0.137E-23
10	1958.603 50(6)*	P(41)	1	0.396E-24
11	1959.530 7	P(32)	3	0.449E-24
12	1960.066 1	P(22)	5	0.516E-24
13	1962.941 6	P(32)	2	0.239E-23

molecular species identification: $1-^{12}\text{C}^{16}\text{O}$, $2-^{13}\text{C}^{16}\text{O}$, $3-^{12}\text{C}^{18}\text{O}$, $4-^{12}\text{C}^{17}\text{O}$, $5-^{13}\text{C}^{18}\text{O}$, $6-^{13}\text{C}^{17}\text{O}$, $7-^{12}\text{C}^{16}\text{O}$ ($v = 2-1$)

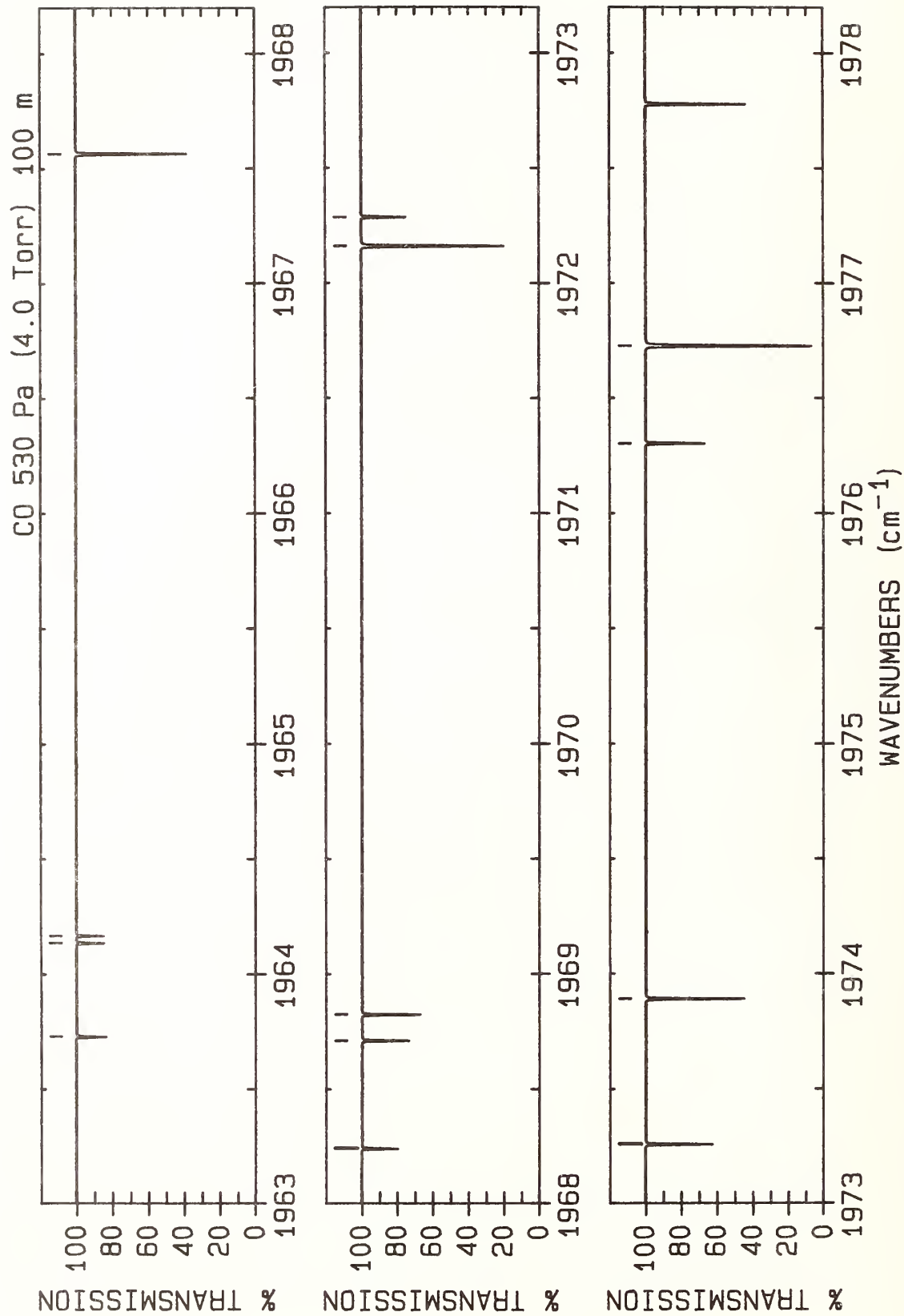

LINE #	WAVENUMBER(unc) (cm ⁻¹)	ROTATIONAL ASSIGNMENT	Mol.	INTENSITY (cm/molecule)
1	1963.728 69(6)*	P(40)	1	0.827E-24
2	1964.135 2	P(31)	3	0.767E-24
3	1964.167 2	P(21)	5	0.716E-24
4	1967.565 3	P(31)	2	0.409E-23
5	1968.240 5	P(20)	5	0.975E-24
6	1968.711 2	P(30)	3	0.129E-23
7	1968.824 71(5)*	P(39)	1	0.169E-23
8	1972.160 4	P(30)	2	0.688E-23
9	1972.285 9	P(19)	5	0.130E-23
10	1973.258 7	P(29)	3	0.212E-23
11	1973.891 41(4)*	P(38)	1	0.341E-23
12	1976.303 4	P(18)	5	0.171E-23
13	1976.726 7	P(29)	2	0.114E-22

molecular species identification: 1-¹²C¹⁶O, 2-¹³C¹⁶O, 3-¹²C¹⁸O, 4-¹²C¹⁷O, 5-¹³C¹⁸O, 6-¹³C¹⁷O, 7-¹²C¹⁶O (v = 2-1)

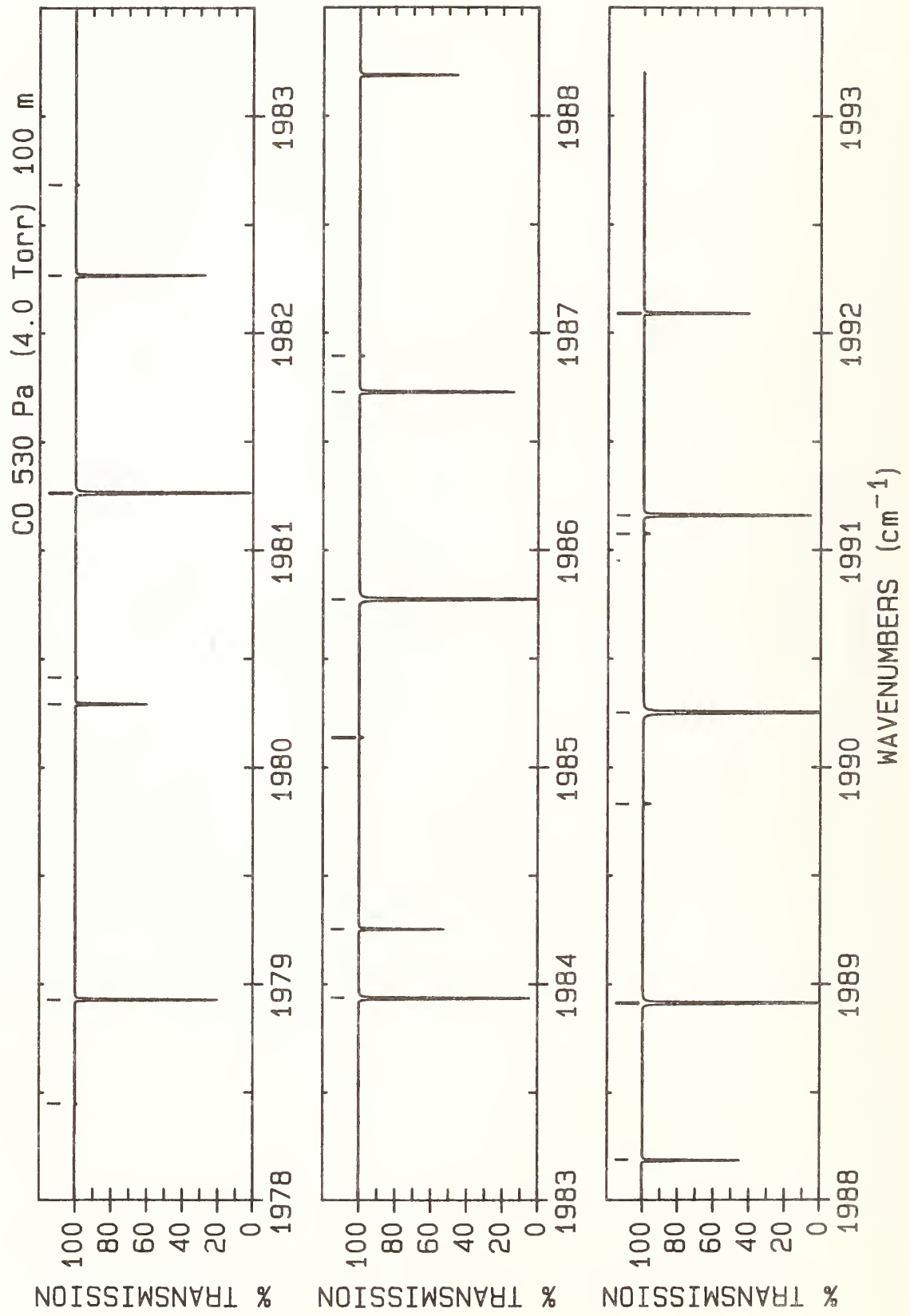

LINE #	WAVENUMBER(unc) (cm ⁻¹)	ROTATIONAL ASSIGNMENT	Mol.	INTENSITY (cm/molecule)
1	1978.446 9	P(23)	6	0.623E-25
2	1978.928 66(4)*	P(37)	1	0.672E-23
3	1980.292 7	P(17)	5	0.219E-23
4	1980.415 1	P(32)	4	0.688E-25
5	1981.264 3	P(28)	2	0.184E-22
6	1982.267 4	P(27)	3	0.545E-23
7	1982.684 9	P(22)	6	0.890E-25
8	1983.936 30(4)*	P(36)	1	0.130E-22
9	1984.253 7	P(16)	5	0.276E-23
10	1985.138 2	P(31)	4	0.119E-24
11	1985.772 9	P(27)	2	0.293E-22
12	1986.728 4	P(26)	3	0.848E-23
13	1986.894 2	P(21)	6	0.125E-24
14	1988.186 5	P(15)	5	0.340E-23
15	1988.914 20(3)*	P(35)	1	0.247E-22
16	1989.831 8	P(30)	4	0.203E-24
17	1990.252 4	P(26)	2	0.457E-22
18	1991.074 8	P(20)	6	0.171E-24
19	1991.160 4	P(25)	3	0.130E-22
20	1992.090 7	P(14)	5	0.410E-23

molecular species identification: 1-¹²C¹⁶O, 2-¹³C¹⁶O, 3-¹²C¹⁸O, 3-¹²C¹⁷O, 4-¹²C¹⁸O, 4-¹²C¹⁷O, 5-¹³C¹⁸O, 5-¹³C¹⁷O, 6-¹³C¹⁶O, 6-¹³C¹⁷O, 7-¹²C¹⁶O (v = 2 - 1)

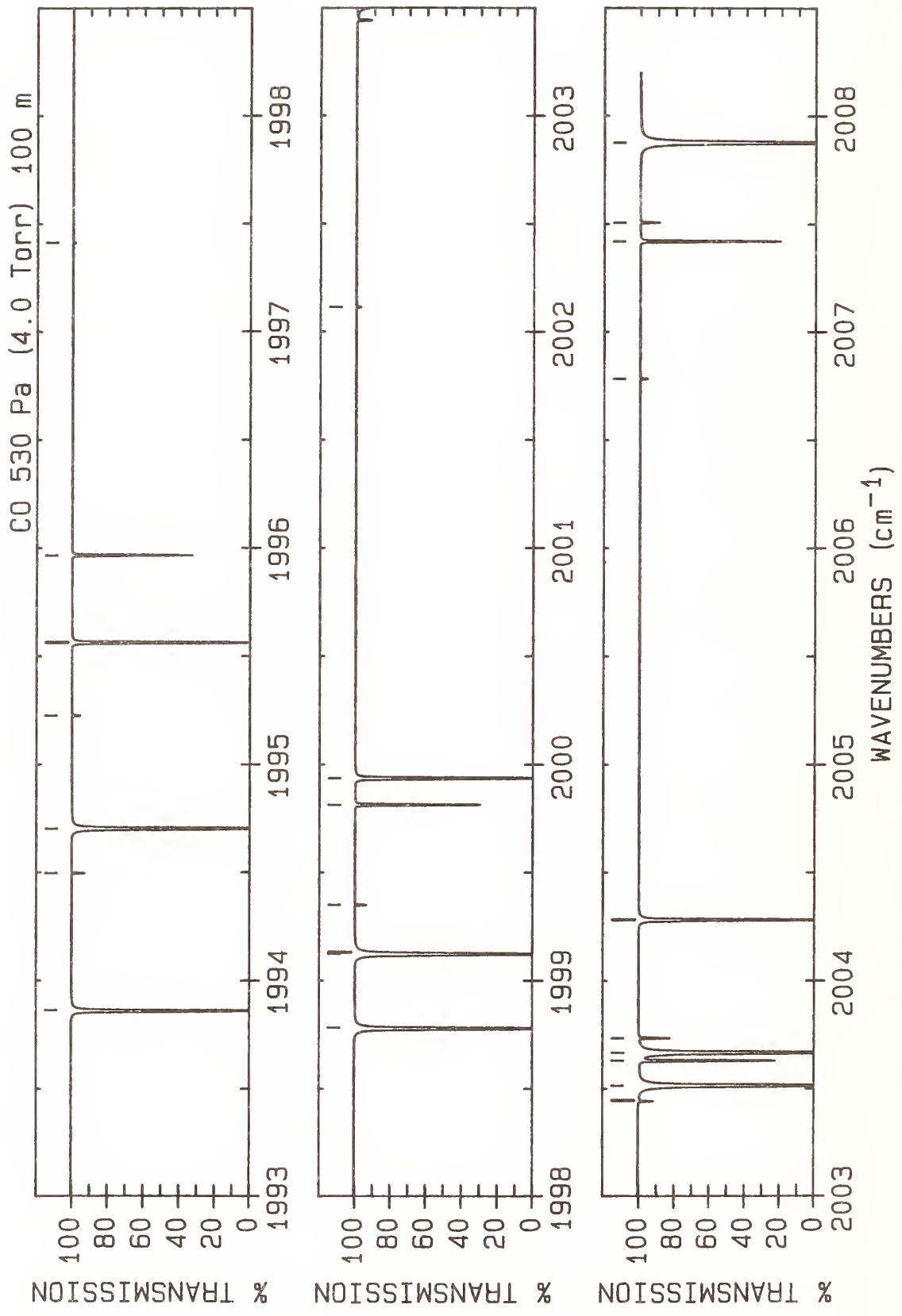

LINE #	WAVENUMBER(unc) (cm ⁻¹)	ROTATIONAL ASSIGNMENT	Mol.	INTENSITY (cm/molecule)
1	1993.862 203(29)*	P(34)	1	0.461E-22
2	1994.496 2	P(29)	4	0.338E-24
3	1994.702 7	P(25)	2	0.699E-22
4	1995.226 5	P(19)	6	0.231E-24
5	1995.563 1	P(24)	3	0.194E-22
6	1995.966 4	P(13)	5	0.483E-23
7	1997.415 29(3)*	P(28)	7	0.807E-25
8	1998.780 175(27)*	P(33)	1	0.842E-22
9	1999.123 5	P(24)	2	0.105E-21
10	1999.130 4	P(28)	4	0.554E-24
11	1999.349 2	P(18)	6	0.304E-24
12	1999.813 3	P(12)	5	0.557E-23
13	1999.936 4	P(23)	3	0.286E-22
14	2002.114 971(29)*	P(27)	7	0.131E-24
15	2003.442 7	P(17)	6	0.394E-24
16	2003.514 9	P(23)	2	0.154E-21
17	2003.631 3	P(11)	5	0.627E-23
18	2003.667 967(25)*	P(32)	1	0.151E-21
19	2003.735 1	P(27)	4	0.890E-24
20	2004.280 4	P(22)	3	0.412E-22
21	2006.783 600(26)*	P(26)	7	0.208E-24
22	2007.420 5	P(10)	5	0.688E-23
23	2007.507 0	P(16)	6	0.499E-24
24	2007.876 6	P(22)	2	0.223E-21

molecular species identification: 1-¹²C¹⁶O, 2-¹³C¹⁶O, 3-¹²C¹⁸O, 4-¹²C¹⁷O, 5-¹³C¹⁸O, 6-¹³C¹⁷O, 7-¹²C¹⁶O (v = 2-1)

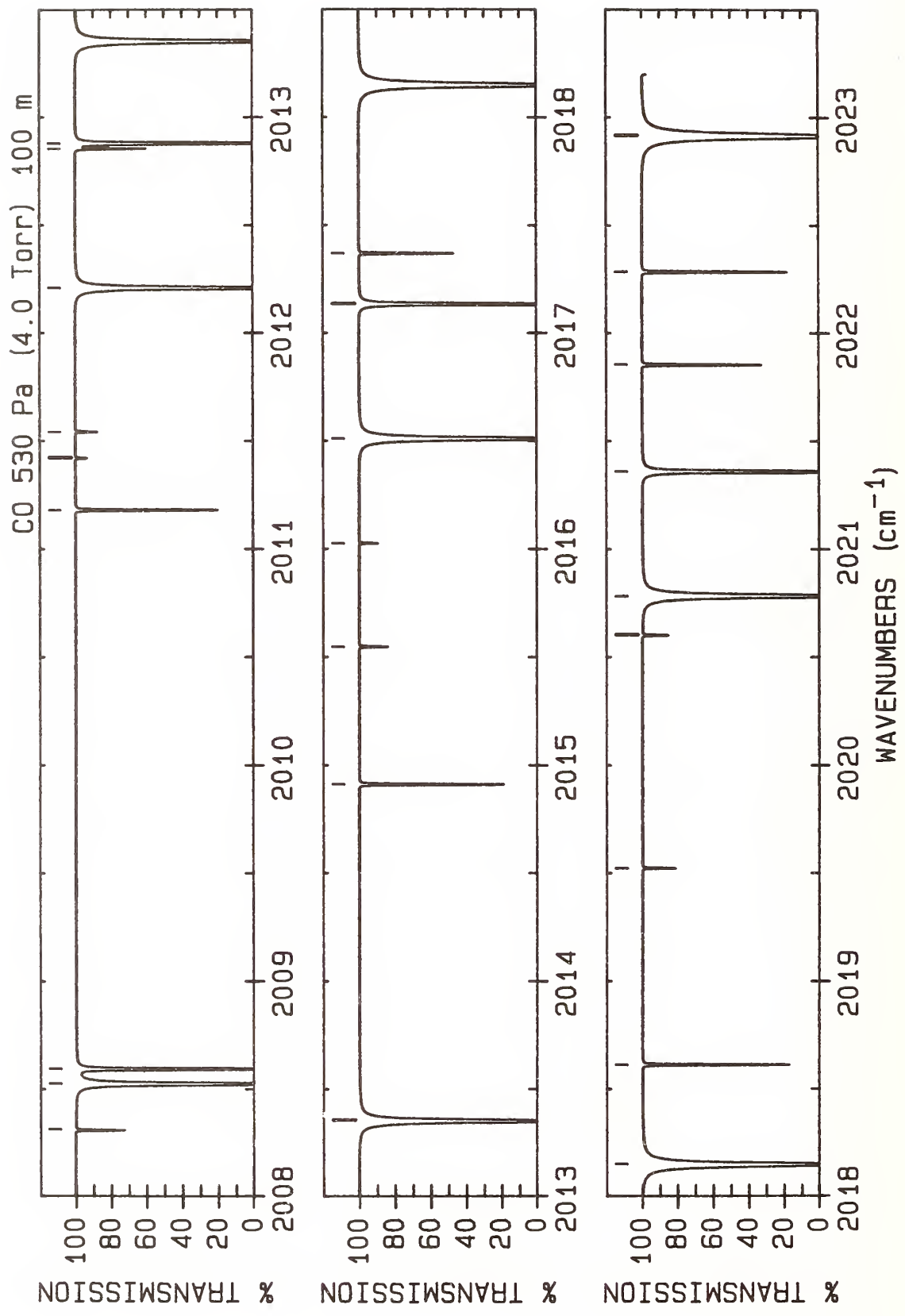

LINE #	WAVENUMBER(unc) (cm^{-1})	ROTATIONAL ASSIGNMENT	Mol.	INTENSITY ($\text{cm}^2/\text{molecule}$)
1	2008.309 9	P(26)	4	0.140E-23
2	2008.525 445(23)*	P(31)	1	0.266E-21
3	2008.594 7	P(21)	3	0.582E-22
4	2011.180 5	P(9)	5	0.735E-23
5	2011.421 033(22)*	P(25)	7	0.323E-24
6	2011.541 9	P(15)	6	0.619E-24
7	2012.208 6	P(21)	2	0.316E-21
8	2012.854 6	P(25)	4	0.216E-23
9	2012.879 2	P(20)	3	0.807E-22
10	2013.352 434(21)*	P(30)	1	0.459E-21
11	2014.911 3	P(8)	5	0.763E-23
12	2015.547 3	P(14)	6	0.751E-24
13	2016.027 125(20)*	P(24)	7	0.493E-24
14	2016.510 7	P(20)	2	0.438E-21
15	2017.134 0	P(19)	3	0.110E-21
16	2017.369 1	P(24)	4	0.328E-23
17	2018.148 820(19)*	P(29)	1	0.776E-21
18	2018.612 8	P(7)	5	0.766E-23
19	2019.523 0	P(13)	6	0.891E-24
20	2020.601 731(17)*	P(23)	7	0.737E-24
21	2020.782 8	P(19)	2	0.596E-21
22	2021.358 7	P(18)	3	0.146E-21
23	2021.853 3	P(23)	4	0.487E-23
24	2022.284 8	P(6)	5	0.741E-23
25	2022.914 447(18)*	P(28)	1	0.129E-20

molecular species identification: $1-^{12}\text{C}^{16}\text{O}$, $2-^{13}\text{C}^{16}\text{O}$, $3-^{12}\text{C}^{18}\text{O}$, $4-^{12}\text{C}^{17}\text{O}$, $5-^{13}\text{C}^{18}\text{O}$, $6-^{13}\text{C}^{17}\text{O}$, $7-^{12}\text{C}^{16}\text{O}$ ($v = 2-1$)

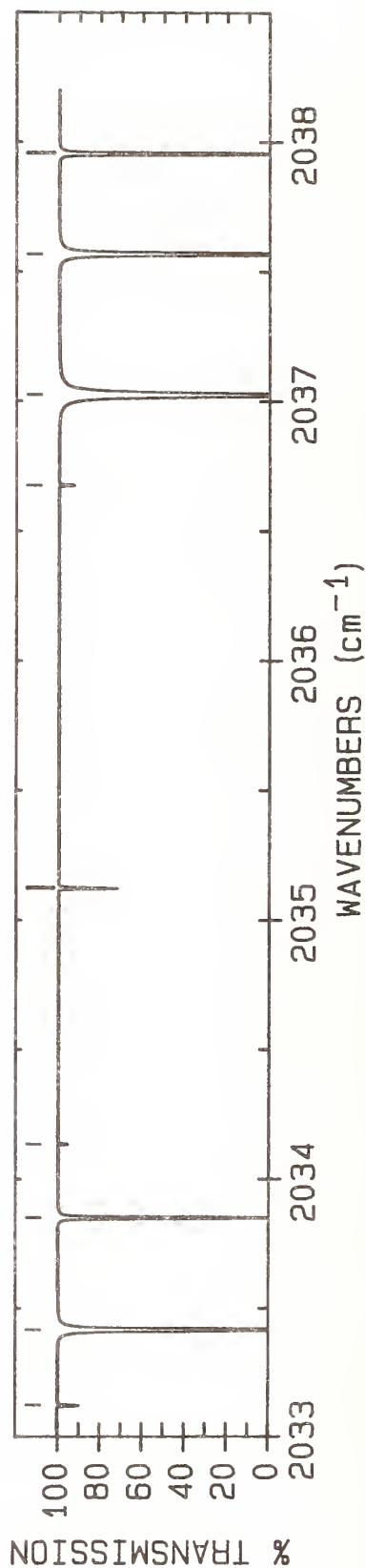
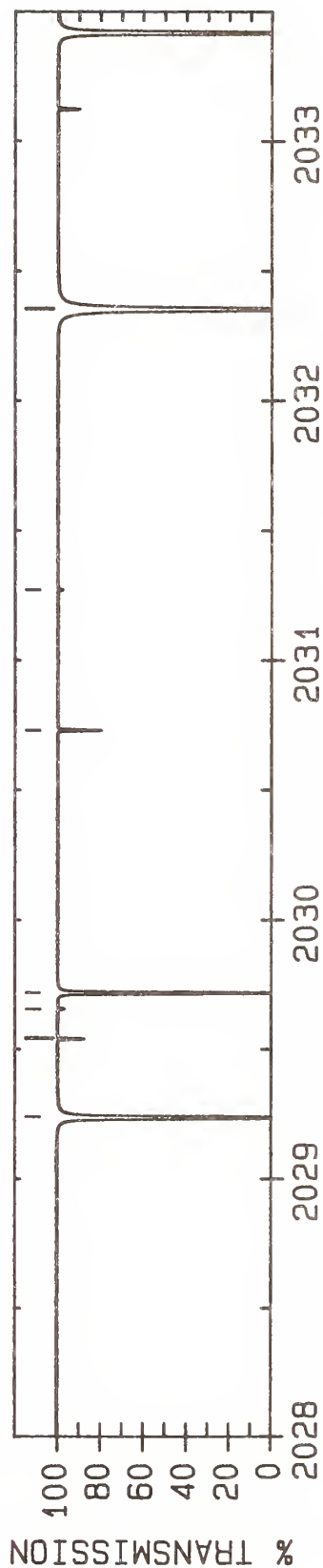
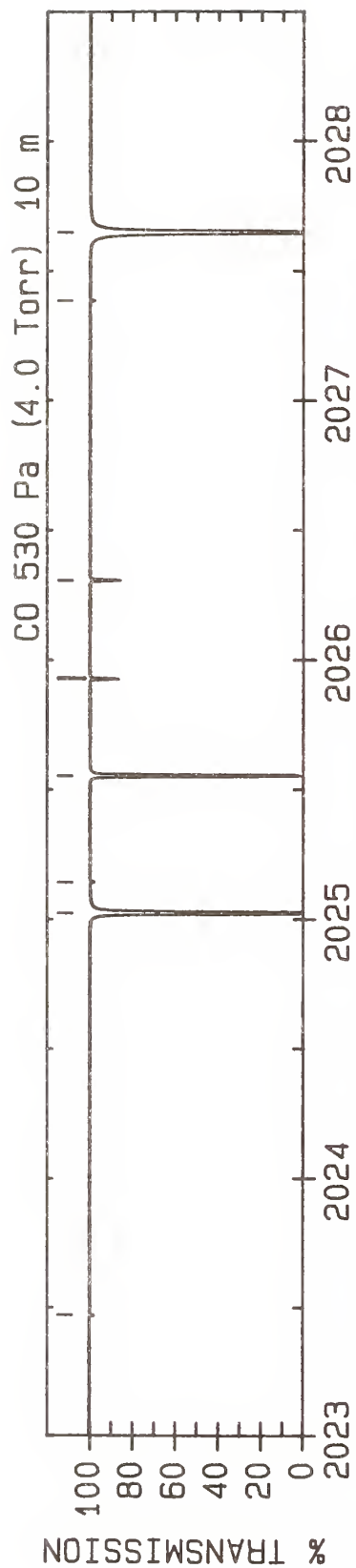

LINE #	WAVENUMBER(unc) (cm ⁻¹)	ROTATIONAL ASSIGNMENT	Mol.	INTENSITY (cm/molecule)
1	2023.469 0	P(12)	6	0.103E-23
2	2025.024 6	P(18)	2	0.794E-21
3	2025.144 704(15)*	P(22)	7	0.108E-23
4	2025.553 2	P(17)	3	0.190E-21
5	2025.927 3	P(5)	5	0.685E-23
6	2026.307 0	P(22)	4	0.708E-23
7	2027.385 1	P(11)	6	0.117E-23
8	2027.649 169(16)*	P(27)	1	0.210E-20
9	2029.236 2	P(17)	2	0.104E-20
10	2029.540 1	P(4)	5	0.598E-23
11	2029.655 899(12)*	P(21)	7	0.155E-23
12	2029.717 6	P(16)	3	0.242E-21
13	2030.730 0	P(21)	4	0.101E-22
14	2031.271 1	P(10)	6	0.129E-23
15	2032.352 842(15)*	P(26)	1	0.334E-20
16	2033.123 0	P(3)	5	0.480E-23
17	2033.417 3	P(16)	2	0.132E-20
18	2033.851 5	P(15)	3	0.302E-21
19	2034.135 170(10)*	P(20)	7	0.218E-23
20	2035.122 3	P(20)	4	0.141E-22
21	2035.127 0	P(9)	6	0.138E-23
22	2036.676 0	P(2)	5	0.338E-23
23	2037.025 319(14)*	P(25)	1	0.522E-20
24	2037.567 9	P(15)	2	0.165E-20
25	2037.954 8	P(14)	3	0.369E-21

molecular species identification: 1-¹²C¹⁶O, 2-¹³C¹⁶O, 3-¹²C¹⁸O, 4-¹²C¹⁷O, 5-¹³C¹⁸O, 6-¹³C¹⁷O, 7-¹²C¹⁶O (v = 2-1)

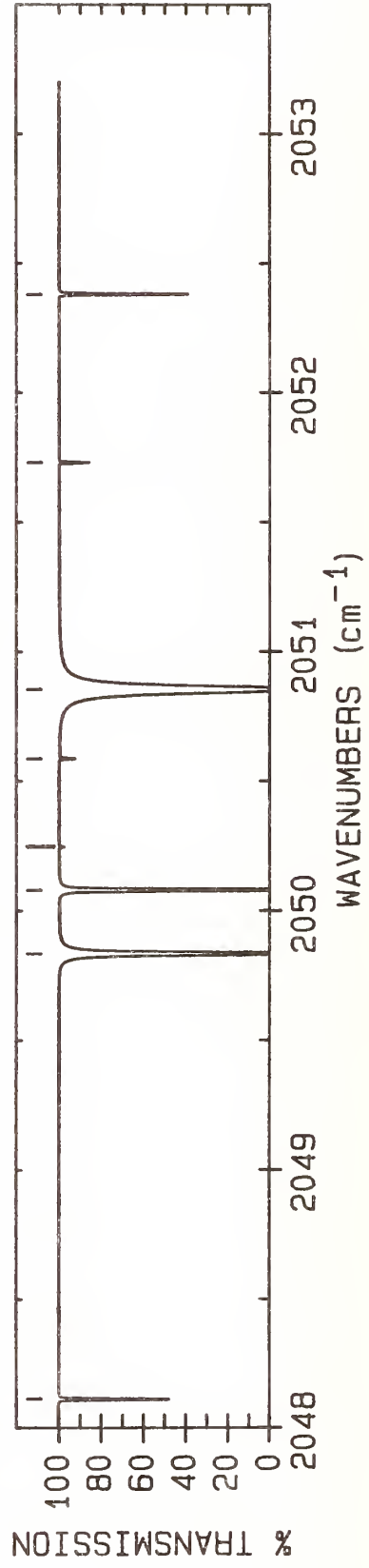
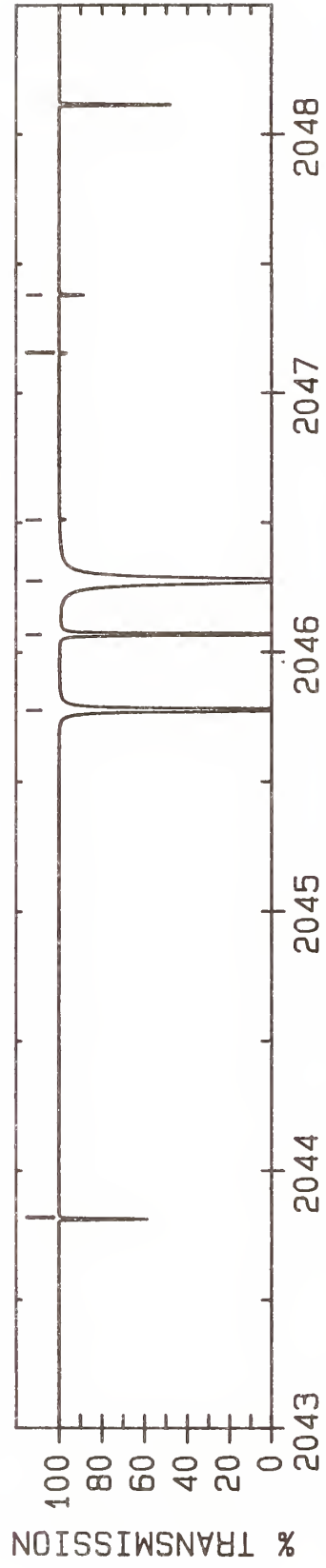
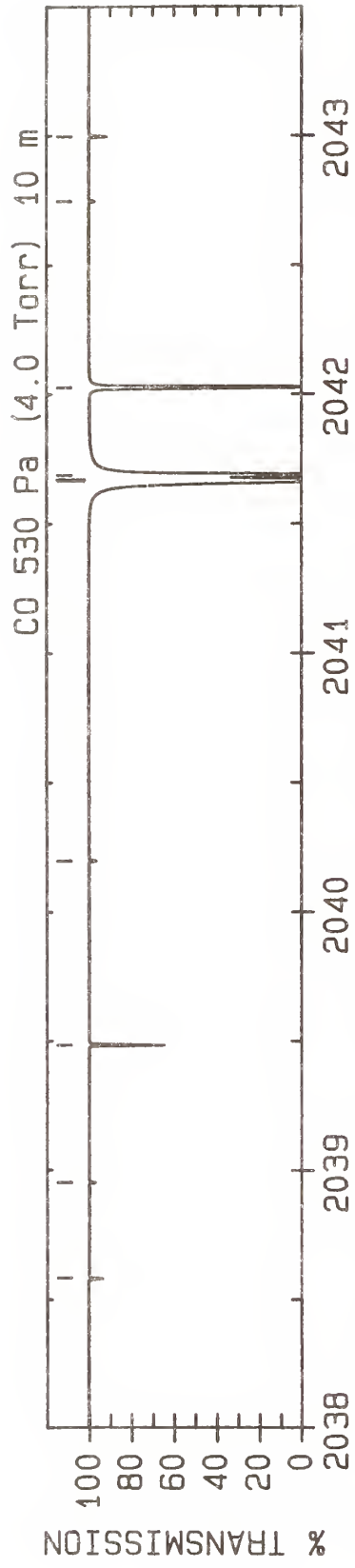

LINE #	WAVENUMBER(unc) (cm ⁻¹)	ROTATIONAL ASSIGNMENT	Mol.	INTENSITY (cm/molecule)
1	2038.582 371(9)*	P(19)	7	0.301E-23
2	2038.952 6	P(8)	6	0.144E-23
3	2039.483 7	P(19)	4	0.193E-22
4	2040.199 0	P(1)	5	0.175E-23
5	2041.666 456(12)*	P(24)	1	0.800E-20
6	2041.687 8	P(14)	2	0.202E-20
7	2042.027 5	P(13)	3	0.441E-21
8	2042.747 7	P(7)	6	0.145E-23
9	2042.997 355(7)*	P(18)	7	0.405E-23
10	2043.814 1	P(18)	4	0.259E-22
11	2045.776 8	P(13)	2	0.241E-20
12	2046.069 5	P(12)	3	0.513E-21
13	2046.276 106(11)*	P(23)	1	0.120E-19
14	2046.512 4	P(6)	6	0.141E-23
15	2047.154 3	R(0)	5	0.179E-23
16	2047.379 977(6)*	P(17)	7	0.535E-23
17	2048.113 3	P(17)	4	0.341E-22
18	2049.834 9	P(12)	2	0.282E-20
19	2050.080 4	P(11)	3	0.584E-21
20	2050.246 4	P(5)	6	0.130E-23
21	2050.586 4	R(1)	5	0.352E-23
22	2050.854 123(10)*	P(22)	1	0.177E-19
23	2051.730 089(5)*	P(16)	7	0.691E-23
24	2052.381 2	P(16)	4	0.437E-22

molecular species identification: 1-¹²C¹⁶O, 2-¹³C¹⁶O, 3-¹²C¹⁸O, 4-¹²C¹⁷O, 5-¹³C¹⁸O, 6-¹³C¹⁷O, 7-¹²C¹⁶O (v = 2-1)

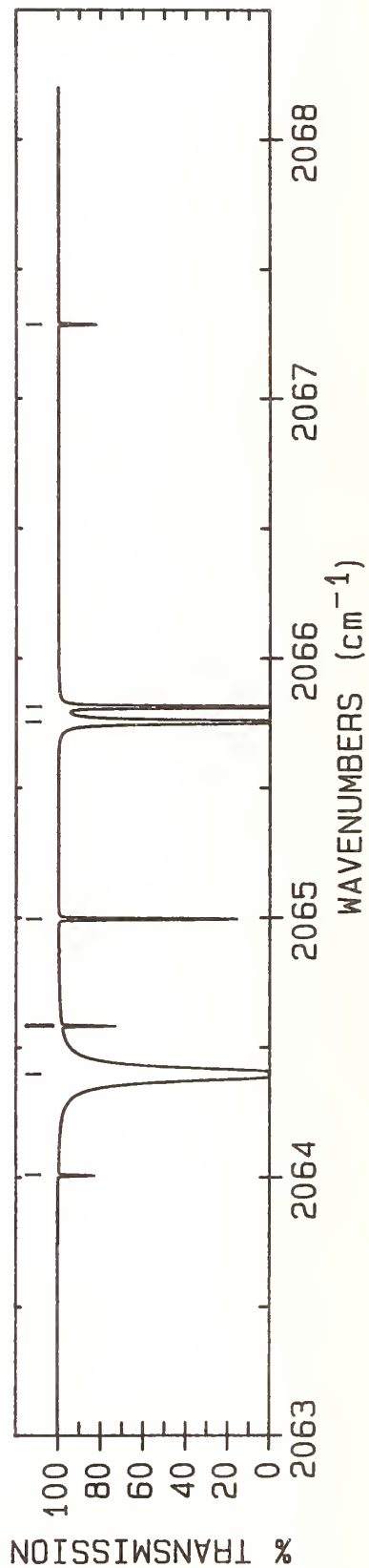
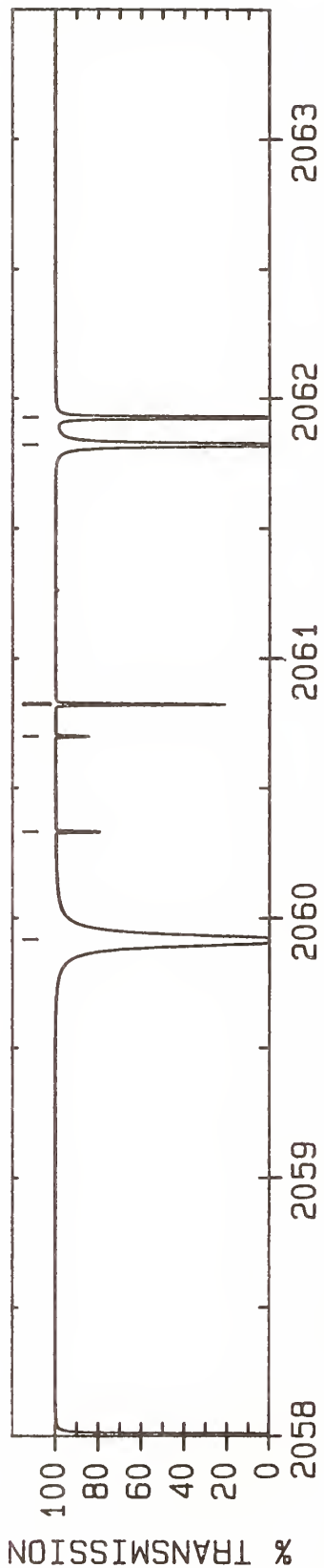
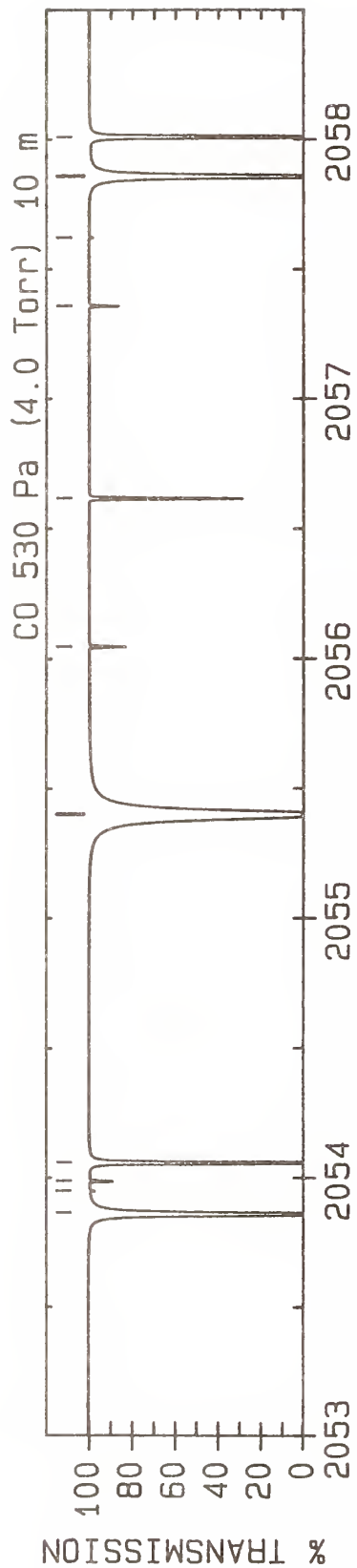

LINE #	WAVENUMBER(unc) (cm ⁻¹)	ROTATIONAL ASSIGNMENT	Mol.	INTENSITY (cm/molecule)
1	2053.861 8	P(11)	2	0.320E-20
2	2053.949 6	P(4)	6	0.114E-23
3	2053.987 9	R(2)	5	0.511E-23
4	2054.060 3	P(10)	3	0.647E-21
5	2055.400 361(9)*	P(21)	1	0.255E-19
6	2056.047 547(4)*	P(15)	7	0.873E-23
7	2056.617 6	P(15)	4	0.550E-22
8	2057.358 8	R(3)	5	0.648E-23
9	2057.621 9	P(3)	6	0.919E-24
10	2057.857 5	P(10)	2	0.355E-20
11	2058.009 1	P(9)	3	0.697E-21
12	2059.914 675(7)*	P(20)	1	0.360E-19
13	2060.332 203(4)*	P(14)	7	0.108E-22
14	2060.698 9	R(4)	5	0.758E-23
15	2060.822 5	P(14)	4	0.676E-22
16	2061.821 8	P(9)	2	0.383E-20
17	2061.926 4	P(8)	3	0.728E-21
18	2064.008 1	R(5)	5	0.837E-23
19	2064.396 918(6)*	P(19)	1	0.497E-19
20	2064.583 910(4)*	P(13)	7	0.130E-22
21	2064.995 6	P(13)	4	0.811E-22
22	2065.754 7	P(8)	2	0.400E-20
23	2065.812 4	P(7)	3	0.736E-21
24	2067.286 3	R(6)	5	0.884E-23

molecular species identification: 1-¹²C¹⁶O, 2--¹³C¹⁶O, 3--¹²C¹⁸O, 4--¹²C¹⁷O, 5--¹³C¹⁸O, 6--¹³C¹⁷O, 7--¹²C¹⁶O (v = 2-1)

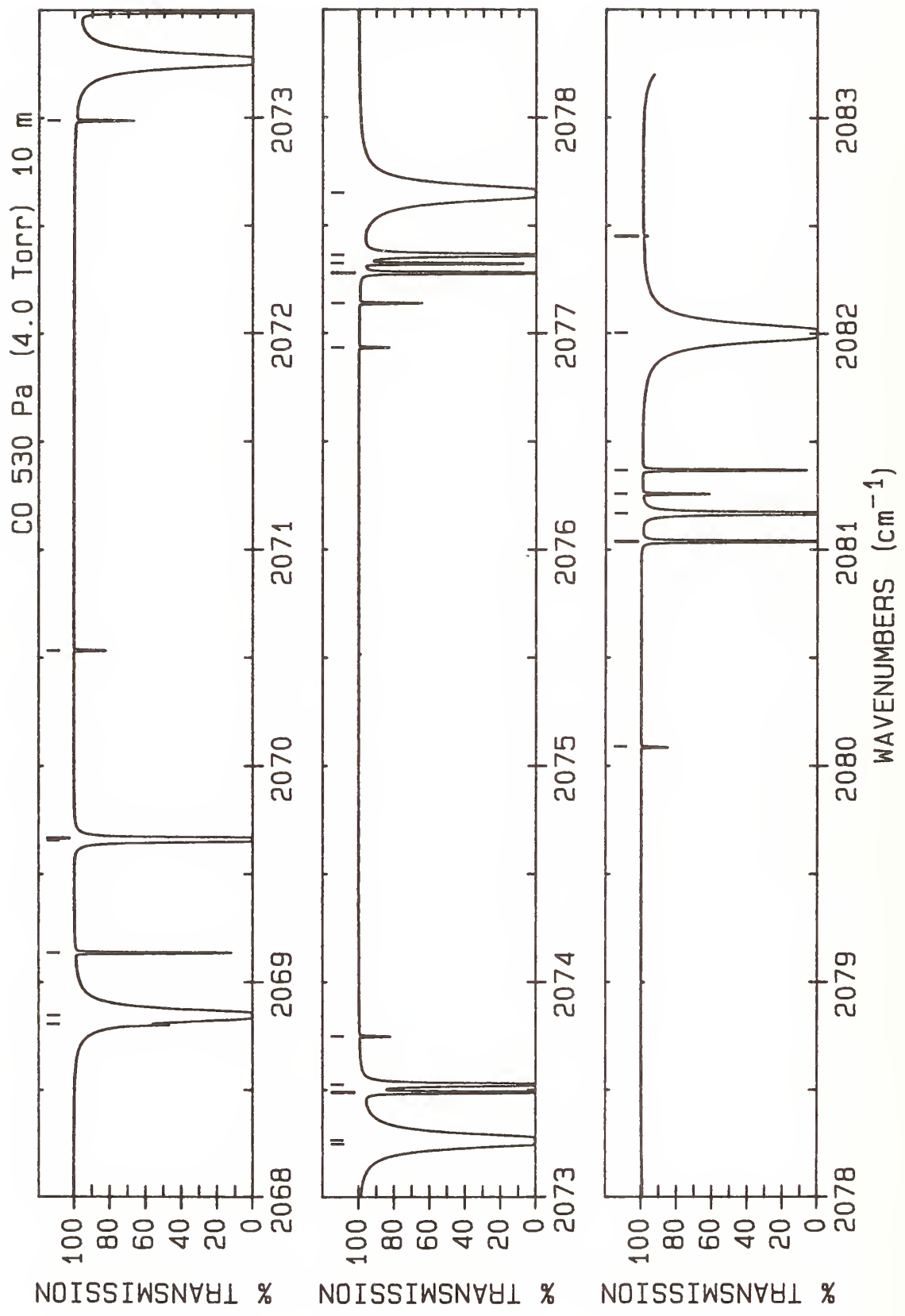

LINE #	WAVENUMBER(unc) (cm ⁻¹)	ROTATIONAL ASSIGNMENT	Mol.	INTENSITY (cm/molecule)
1	2068.802 523(4)*	P(12)	7	0.153E-22
2	2068.846 944(5)*	P(18)	1	0.673E-19
3	2069.136 8	P(12)	4	0.950E-22
4	2069.655 8	P(7)	2	0.405E-20
5	2069.666 7	P(6)	3	0.716E-21
6	2070.533 3	R(7)	5	0.898E-23
7	2072.987 894(5)*	P(11)	7	0.175E-22
8	2073.246 0	P(11)	4	0.109E-21
9	2073.264 606(4)*	P(17)	1	0.891E-19
10	2073.489 3	P(5)	3	0.665E-21
11	2073.525 3	P(6)	2	0.394E-20
12	2073.749 1	R(8)	5	0.884E-23
13	2076.933 4	R(9)	5	0.844E-23
14	2077.139 877(5)*	P(10)	7	0.196E-22
15	2077.280 0	P(4)	3	0.582E-21
16	2077.323 1	P(10)	4	0.121E-21
17	2077.362 7	P(5)	2	0.366E-20
18	2077.649 757(4)*	P(16)	1	0.115E-18
19	2080.086 3	R(10)	5	0.785E-23
20	2081.038 7	P(3)	3	0.470E-21
21	2081.168 2	P(4)	2	0.321E-20
22	2081.258 325(6)*	P(9)	7	0.212E-22
23	2081.367 9	P(9)	4	0.131E-21
24	2082.002 253(3)*	P(15)	1	0.146E-18
25	2082.451 6	R(3)	6	0.124E-23

molecular species identification: 1-¹²C¹⁶O, 2-¹³C¹⁶O, 3-¹²C¹⁸O, 4-¹²C¹⁷O, 5-¹³C¹⁸O, 6-¹³C¹⁷O, 7-¹²C¹⁶O (v = 2-1)

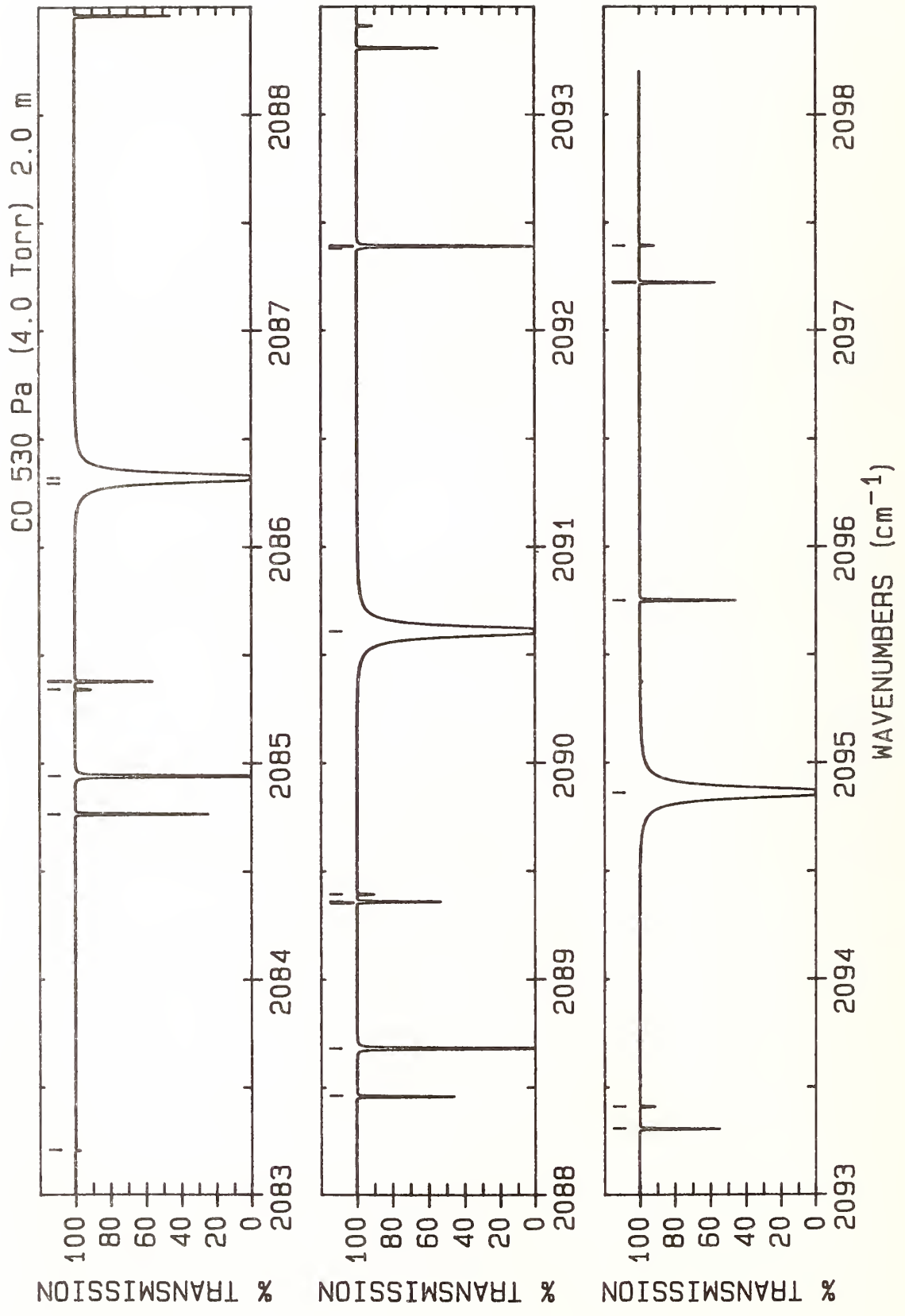

LINE #	WAVENUMBER(unc) (cm ⁻¹)	ROTATIONAL ASSIGNMENT	Mol.	INTENSITY (cm/molecule)
1	2083.207 5	R(11)	5	0.711E-23
2	2084.765 3	P(2)	3	0.331E-21
3	2084.941 4	P(3)	2	0.259E-20
4	2085.343 092(6)*	P(8)	7	0.223E-22
5	2085.380 3	P(8)	4	0.137E-21
6	2086.297 0	R(12)	5	0.630E-23
7	2086.321 944(3)*	P(14)	1	0.181E-18
8	2088.459 7	P(1)	3	0.172E-21
9	2088.682 4	P(2)	2	0.182E-20
10	2089.354 6	R(13)	5	0.545E-23
11	2089.360 0	P(7)	4	0.139E-21
12	2089.394 030(7)*	P(7)	7	0.227E-22
13	2090.608 687(3)*	P(13)	1	0.218E-18
14	2092.380 3	R(14)	5	0.461E-23
15	2092.390 9	P(1)	2	0.947E-21
16	2093.307 1	P(6)	4	0.136E-21
17	2093.410 993(7)*	P(6)	7	0.222E-22
18	2094.862 332(4)*	P(12)	1	0.258E-18
19	2095.751 0	R(0)	3	0.176E-21
20	2097.221 4	P(5)	4	0.126E-21
21	2097.393 834(8)*	P(5)	7	0.207E-22

molecular species identification: 1-¹²C¹⁶O, 2-¹³C¹⁶O, 3-¹²C¹⁸O, 4-¹²C¹⁷O, 5-¹³C¹⁸O, 6-¹³C¹⁷O, 7-¹²C¹⁶O (v = 2-1)

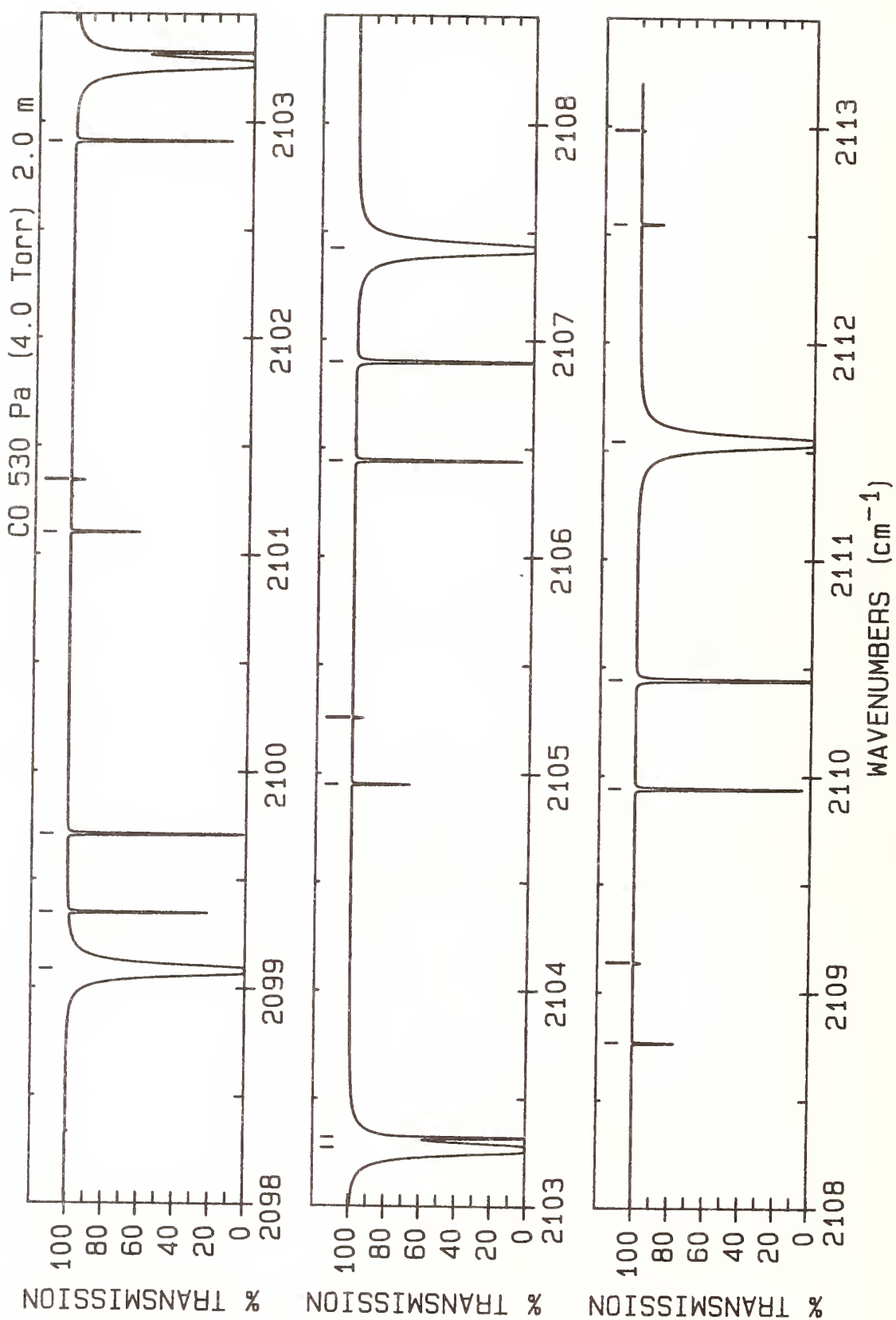

LINE #	WAVENUMBER(unc) (cm ⁻¹)	ROTATIONAL ASSIGNMENT	Mol.	INTENSITY (cm/molecule)
1	2099.082 735(4)*	P(11)	1	0.296E-18
2	2099.347 8	R(1)	3	0.345E-21
3	2099.710 0	R(0)	2	0.968E-21
4	2101.102 6	P(4)	4	0.111E-21
5	2101.342 406(8)*	P(4)	7	0.182E-22
6	2102.911 7	R(2)	3	0.501E-21
7	2103.269 747(5)*	P(10)	1	0.331E-18
8	2103.320 4	R(1)	2	0.190E-20
9	2104.950 7	P(3)	4	0.897E-22
10	2105.256 563(8)*	P(3)	7	0.147E-22
11	2106.442 7	R(3)	3	0.634E-21
12	2106.897 8	R(2)	2	0.276E-20
13	2107.423 222(6)*	P(9)	1	0.360E-18
14	2108.765 6	P(2)	4	0.632E-22
15	2109.136 156(8)*	P(2)	7	0.104E-22
16	2109.940 7	R(4)	3	0.740E-21
17	2110.442 0	R(3)	2	0.350E-20
18	2111.543 014(6)*	P(8)	1	0.379E-18
19	2112.547 0	P(1)	4	0.329E-22
20	2112.981 040(8)*	P(1)	7	0.541E-23

molecular species identification: 1-¹²C¹⁶O, 2-¹³C¹⁶O, 3-¹²C¹⁸O, 3-¹²C¹⁷O, 4-¹²C¹⁸O, 4-¹²C¹⁷O, 5-¹³C¹⁸O, 6-¹³C¹⁷O, 7-¹²C¹⁶O (v = 2-1)

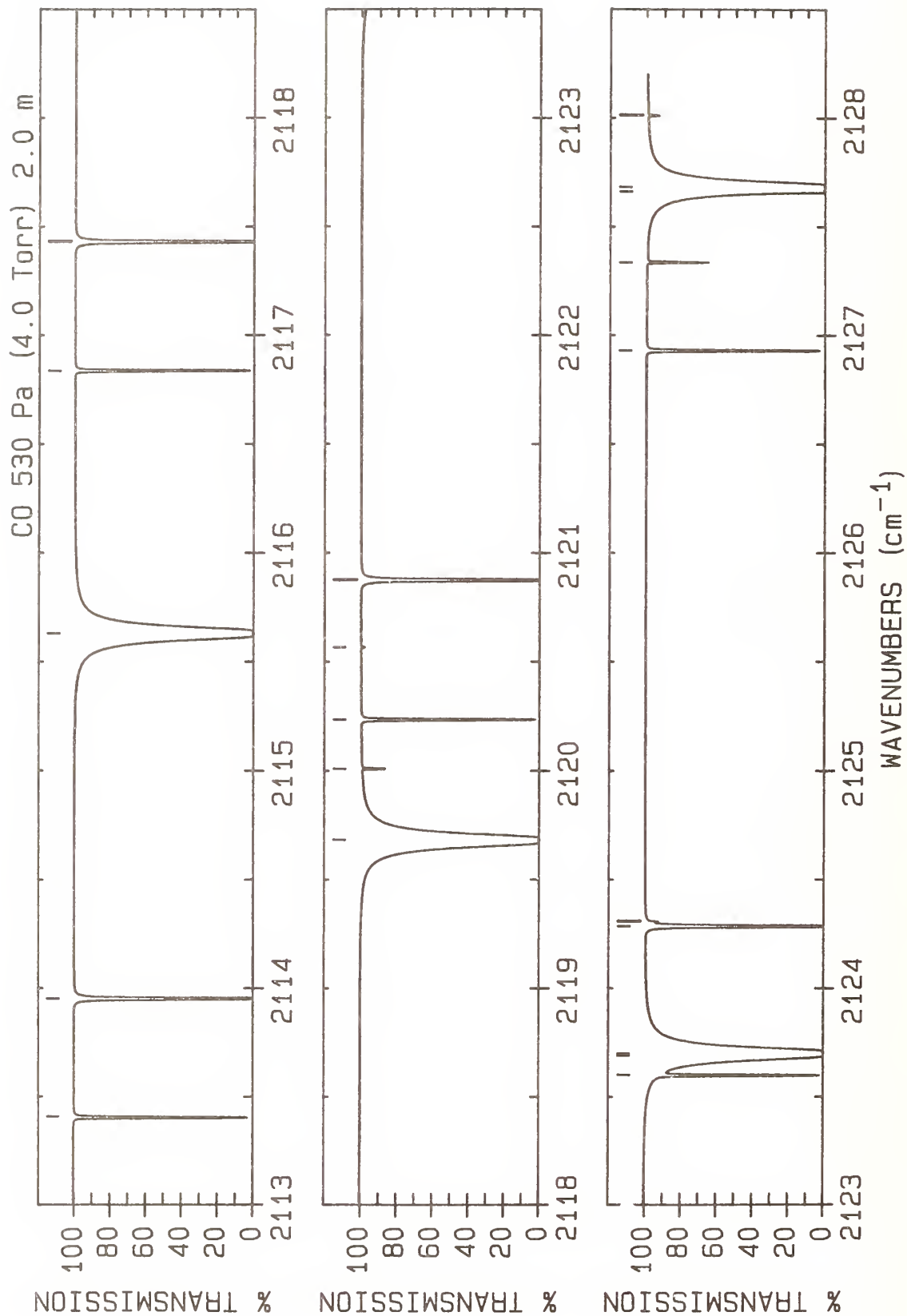

LINE #	WAVENUMBER(unc) (cm ⁻¹)	ROTATIONAL ASSIGNMENT	Mol.	INTENSITY (cm/molecule)
1	2113.405 5	R(5)	3	0.813E-21
2	2113.953 0	R(4)	2	0.407E-20
3	2115.628 975(7)*	P(7)	1	0.386E-18
4	2116.836 9	R(6)	3	0.854E-21
5	2117.430 6	R(5)	2	0.448E-20
6	2119.680 959(8)*	P(6)	1	0.378E-18
7	2120.009 1	R(0)	4	0.336E-22
8	2120.234 9	R(7)	3	0.863E-21
9	2120.566 092(9)*	R(0)	7	0.553E-23
10	2120.874 7	R(6)	2	0.470E-20
11	2123.599 2	R(8)	3	0.844E-21
12	2123.689 5	R(1)	4	0.661E-22
13	2123.698 818(8)*	P(5)	1	0.353E-18
14	2124.285 1	R(7)	2	0.475E-20
15	2124.305 966(9)*	R(1)	7	0.109E-22
16	2126.929 9	R(9)	3	0.800E-21
17	2127.336 0	R(2)	4	0.957E-22
18	2127.661 8	R(8)	2	0.464E-20
19	2127.682 406(8)*	P(4)	1	0.311E-18
20	2128.010 543(8)*	R(2)	7	0.157E-22

molecular species identification: 1-¹²C¹⁶O, 2-¹³C¹⁶O, 3-¹²C¹⁸O, 4-¹²C¹⁷O, 5-¹³C¹⁸O, 6-¹³C¹⁷O, 7-¹²C¹⁶O (v = 2-1)

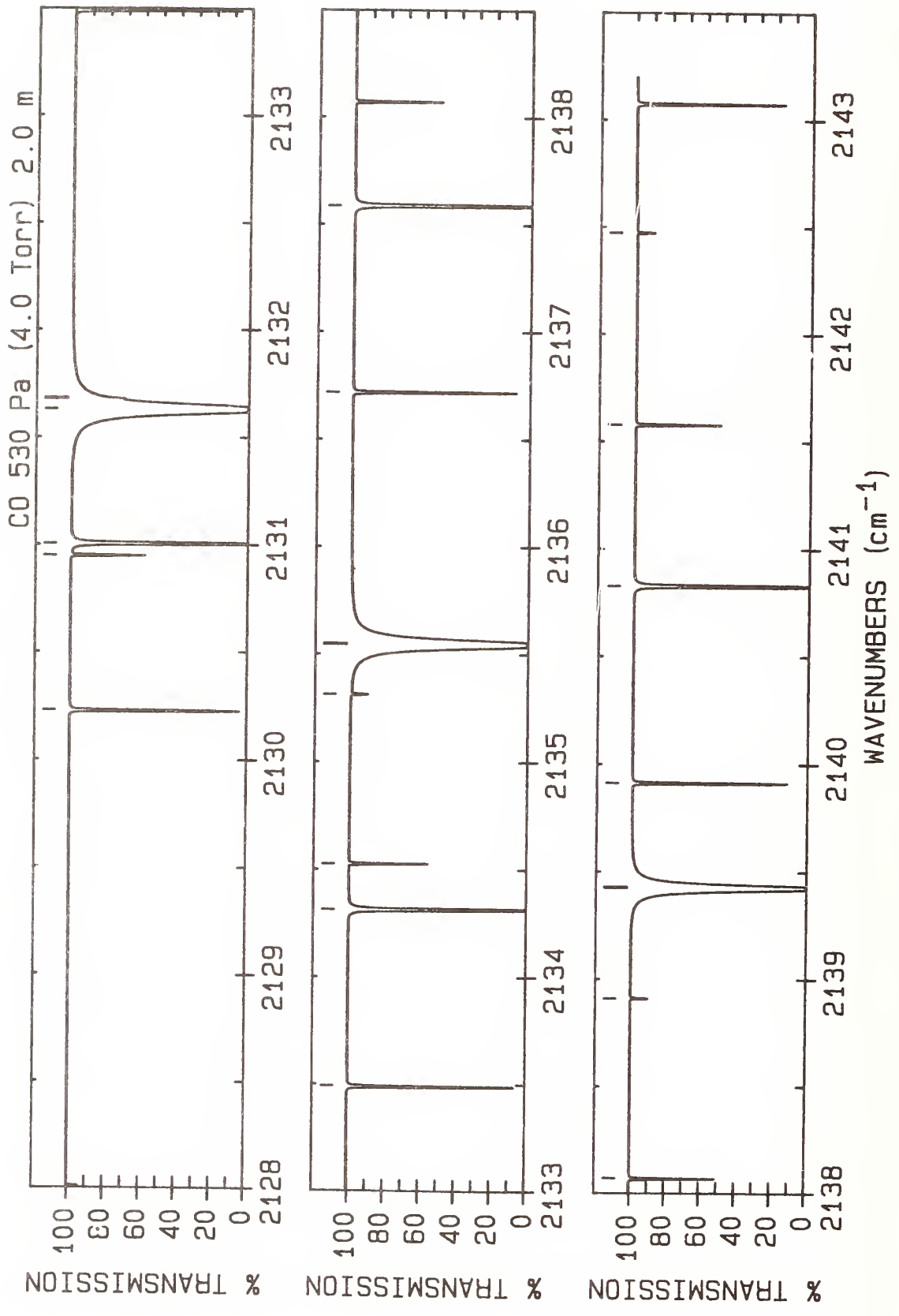

LINE #	WAVENUMBER(unc) (cm ⁻¹)	ROTATIONAL ASSIGNMENT	Mol.	INTENSITY (cm/molecule)
1	2130.226 7	R(10)	3	0.738E-21
2	2130.948 3	R(3)	4	0.121E-21
3	2131.004 5	R(9)	2	0.440E-20
4	2131.631 575(9)*	P(3)	1	0.252E-18
5	2131.679 676(8)*	R(3)	7	0.199E-22
6	2133.489 5	R(11)	3	0.663E-21
7	2134.313 1	R(10)	2	0.405E-20
8	2134.526 4	R(4)	4	0.141E-21
9	2135.313 218(8)*	R(4)	7	0.231E-22
10	2135.546 180(9)*	P(2)	1	0.178E-18
11	2136.718 1	R(12)	3	0.581E-21
12	2137.587 6	R(11)	2	0.364E-20
13	2138.070 1	R(5)	4	0.155E-21
14	2138.911 022(8)*	R(5)	7	0.253E-22
15	2139.426 072(9)*	P(1)	1	0.924E-19
16	2139.912 5	R(13)	3	0.497E-21
17	2140.827 7	R(12)	2	0.318E-20
18	2141.579 3	R(6)	4	0.162E-21
19	2142.472 942(8)*	R(6)	7	0.265E-22

molecular species identification: 1-¹²C¹⁶O, 2-¹³C¹⁶O, 3-¹²C¹⁸O, 4-¹²C¹⁷O, 5-¹³C¹⁸O, 6-¹³C¹⁷O, 7-¹²C¹⁶O (v = 2-1)

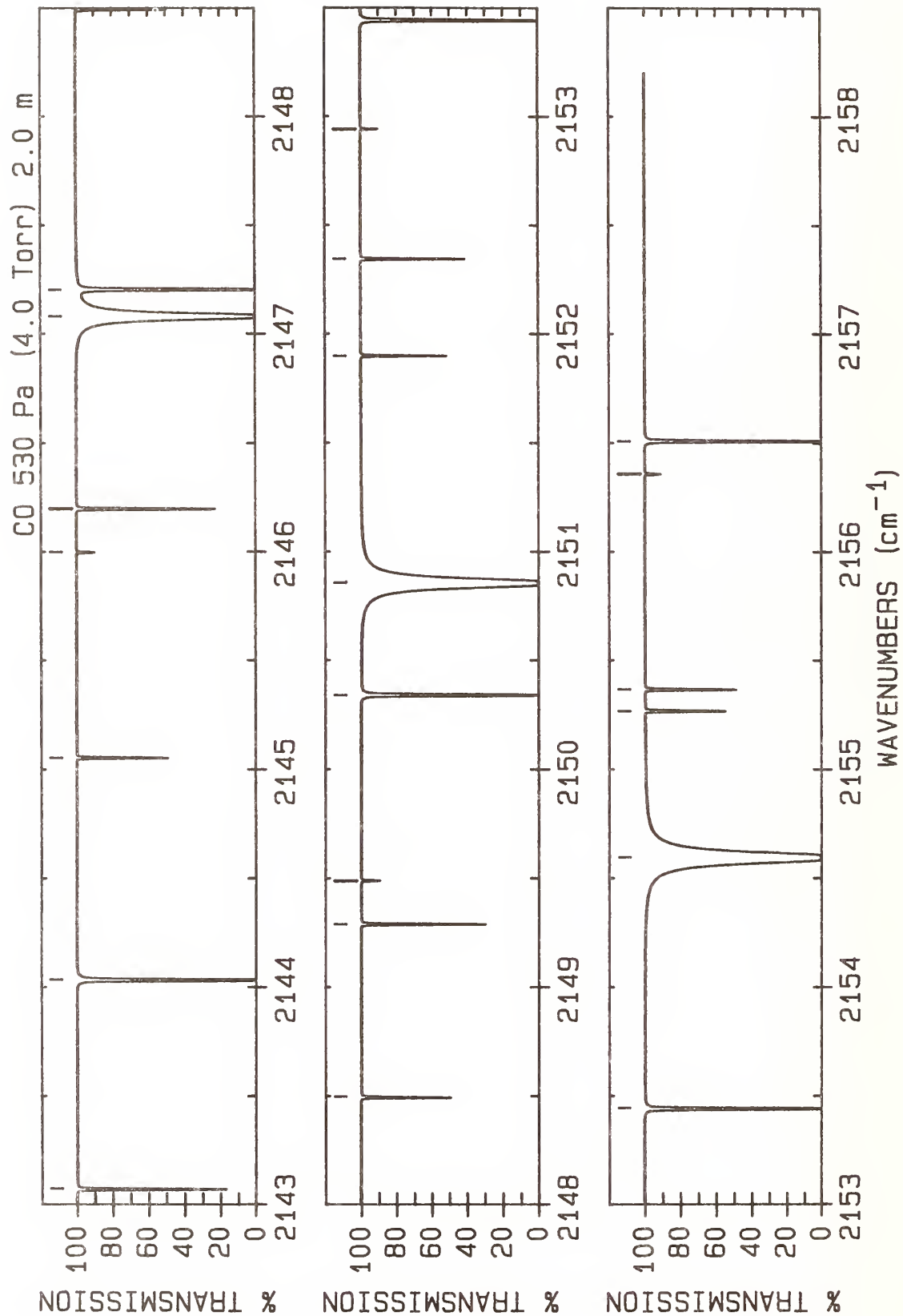

LINE #	WAVENUMBER(unc) (cm ⁻¹)	ROTATIONAL ASSIGNMENT	Mol.	INTENSITY (cm/molecule)
1	2143.072 6	R(14)	3	0.416E-21
2	2144.033 4	R(13)	2	0.272E-20
3	2145.053 8	R(7)	4	0.163E-21
4	2145.998 831(7)*	R(7)	7	0.266E-22
5	2146.198 0	R(15)	3	0.340E-21
6	2147.081 133(9)*	R(0)	1	0.945E-19
7	2147.204 5	R(14)	2	0.228E-20
8	2148.493 5	R(8)	4	0.159E-21
9	2149.288 9	R(16)	3	0.272E-21
10	2149.488 542(7)*	R(8)	7	0.259E-22
11	2150.340 9	R(15)	2	0.186E-20
12	2150.856 008(9)*	R(1)	1	0.186E-18
13	2151.898 3	R(9)	4	0.150E-21
14	2152.344 9	R(17)	3	0.214E-21
15	2152.941 928(6)*	R(9)	7	0.244E-22
16	2153.442 4	R(16)	2	0.149E-20
17	2154.595 583(8)*	R(2)	1	0.269E-18
18	2155.268 0	R(10)	4	0.138E-21
19	2155.366 1	R(18)	3	0.164E-21
20	2156.358 843(6)*	R(10)	7	0.223E-22
21	2156.508 9	R(17)	2	0.116E-20

molecular species identification: 1-¹²C¹⁶O, 2-¹³C¹⁶O, 3-¹²C¹⁸O, 3-¹²C¹⁷O, 4-¹²C¹⁸O, 4-¹²C¹⁷O, 5-¹³C¹⁸O, 6-¹³C¹⁷O, 7-¹²C¹⁶O (v = 2-1)

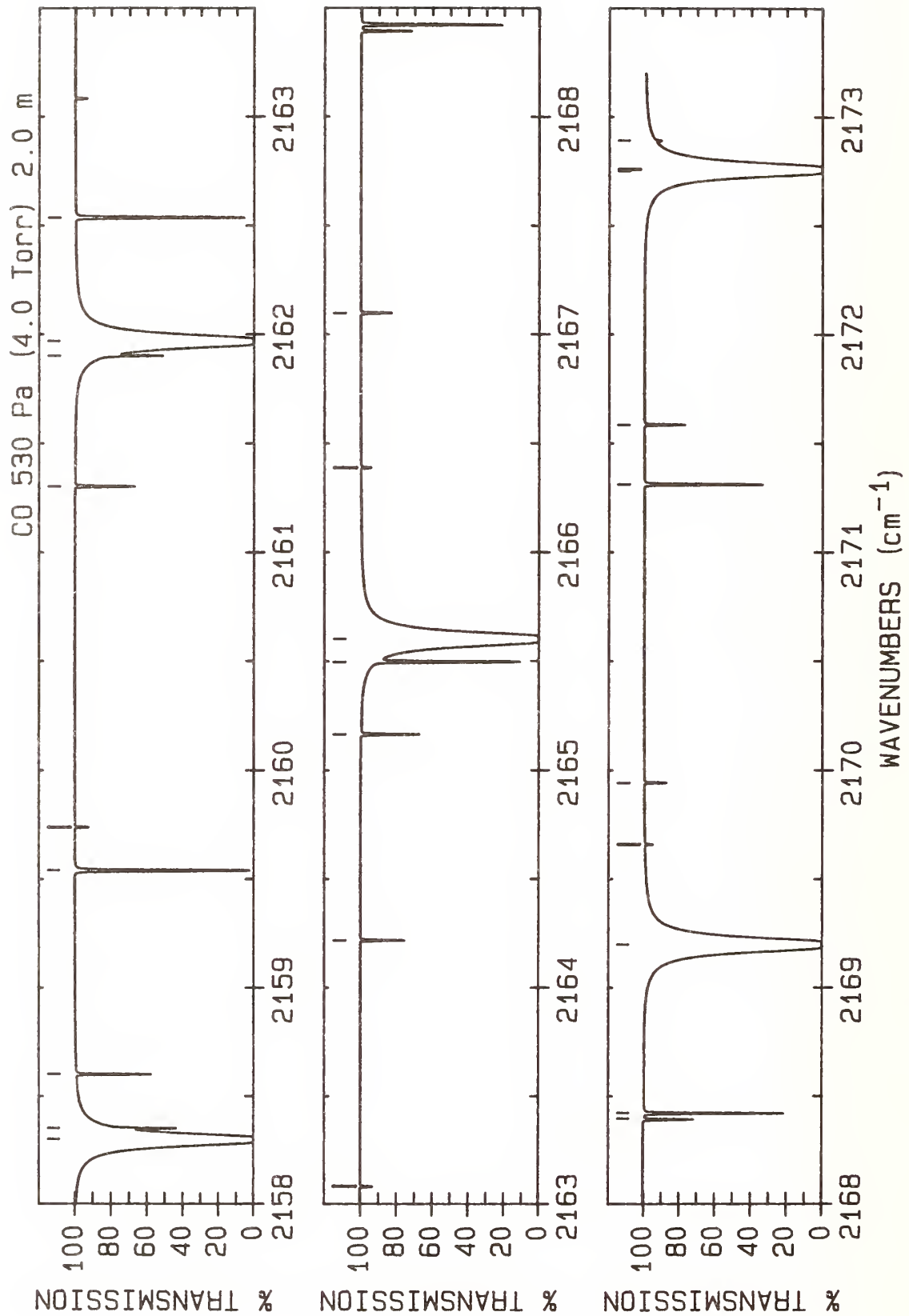

LINE #	WAVENUMBER(unc) (cm ⁻¹)	ROTATIONAL ASSIGNMENT	Mol.	INTENSITY (cm/molecule)
1	2158.299 712(8)*	R(3)	1	0.340E-18
2	2158.352 1	R(19)	3	0.123E-21
3	2158.602 5	R(11)	4	0.123E-21
4	2159.540 3	R(18)	2	0.894E-21
5	2159.739 140(5)*	R(11)	7	0.199E-22
6	2161.303 0	R(20)	3	0.909E-22
7	2161.901 6	R(12)	4	0.108E-21
8	2161.968 247(8)*	R(4)	1	0.395E-18
9	2162.536 4	R(19)	2	0.671E-21
10	2163.082 673(5)*	R(12)	7	0.173E-22
11	2164.218 6	R(21)	3	0.657E-22
12	2165.165 2	R(13)	4	0.916E-22
13	2165.497 1	R(20)	2	0.494E-21
14	2165.601 042(7)*	R(5)	1	0.432E-18
15	2166.389 295(5)*	R(13)	7	0.147E-22
16	2167.098 7	R(22)	3	0.466E-22
17	2168.393 2	R(14)	4	0.762E-22
18	2168.422 3	R(21)	2	0.357E-21
19	2169.197 950(6)*	R(6)	1	0.451E-18
20	2169.658 859(5)*	R(14)	7	0.122E-22
21	2169.943 2	R(23)	3	0.323E-22
22	2171.311 9	R(22)	2	0.252E-21
23	2171.585 4	R(15)	4	0.619E-22
24	2172.752 0	R(24)	3	0.220E-22
25	2172.758 825(6)*	R(7)	1	0.453E-18
26	2172.891 220(5)*	R(15)	7	0.984E-23

molecular species identification: 1-¹²C¹⁶O, 2-¹³C¹⁶O, 3-¹²C¹⁸O, 3-¹²C¹⁷O, 4-¹²C¹⁷O, 5-¹³C¹⁸O, 6-¹³C¹⁷O, 7-¹²C¹⁶O (v = 2-1)

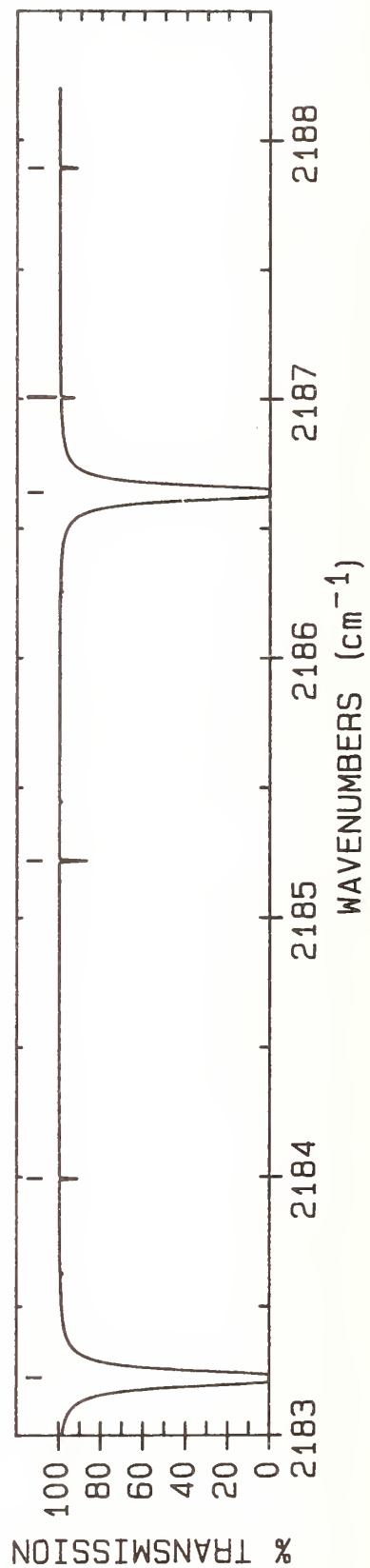
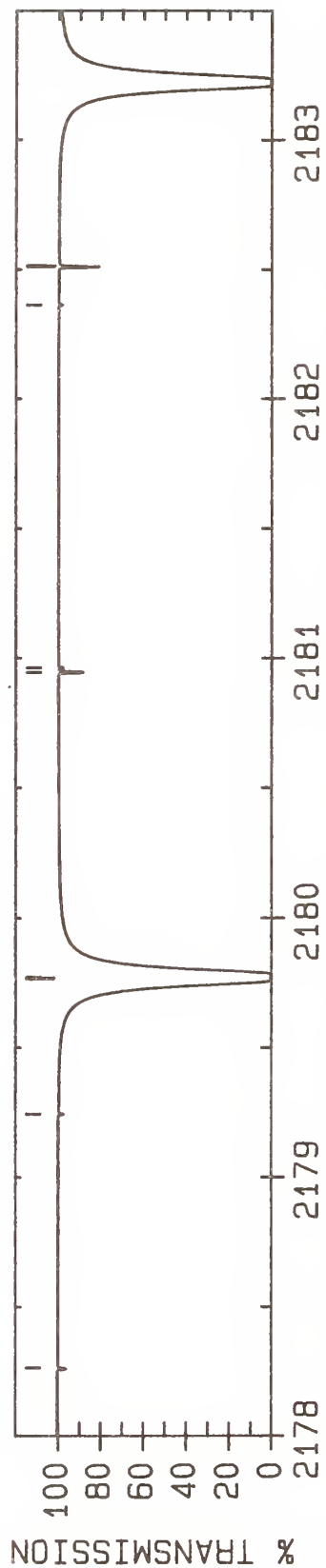
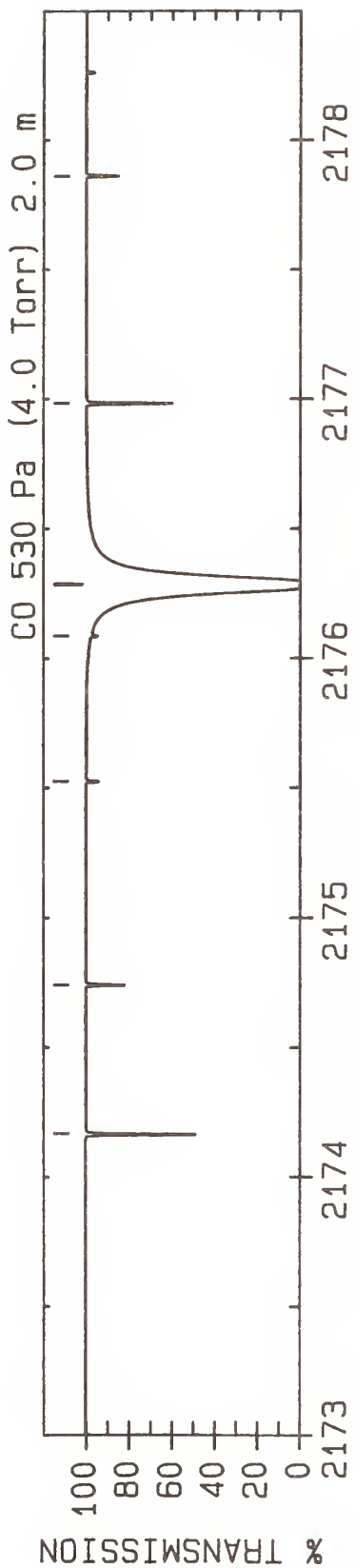

LINE #	WAVENUMBER(unc) (cm ⁻¹)	ROTATIONAL ASSIGNMENT	Mol.	INTENSITY (cm/molecule)
1	2174.165 6	R(23)	2	0.175E-21
2	2174.741 7	R(16)	4	0.493E-22
3	2175.525 0	R(25)	3	0.147E-22
4	2176.086 230(6)*	R(16)	7	0.779E-23
5	2176.283 519(5)*	R(8)	1	0.440E-18
6	2176.983 4	R(24)	2	0.119E-21
7	2177.862 0	R(17)	4	0.383E-22
8	2178.261 9	R(26)	3	0.966E-23
9	2179.243 744(7)*	R(17)	7	0.603E-23
10	2179.765 2	R(25)	2	0.794E-22
11	2179.771 887(4)*	R(9)	1	0.414E-18
12	2180.946 0	R(18)	4	0.292E-22
13	2180.962 8	R(27)	3	0.622E-23
14	2182.363 615(9)*	R(18)	7	0.457E-23
15	2182.510 7	R(26)	2	0.520E-22
16	2183.223 781(4)*	R(10)	1	0.378E-18
17	2183.993 8	R(19)	4	0.218E-22
18	2185.220 0	R(27)	2	0.334E-22
19	2186.639 055(3)*	R(11)	1	0.336E-18
20	2187.005 0	R(20)	4	0.159E-22
21	2187.892 7	R(28)	2	0.211E-22

molecular species identification: 1-¹²C¹⁶O, 2-¹³C¹⁶O, 3-¹²C¹⁸O, 3-¹²C¹⁷O, 4-¹²C¹⁷O, 5-¹³C¹⁸O, 6-¹³C¹⁷O, 7-¹²C¹⁶O (v = 2-1)

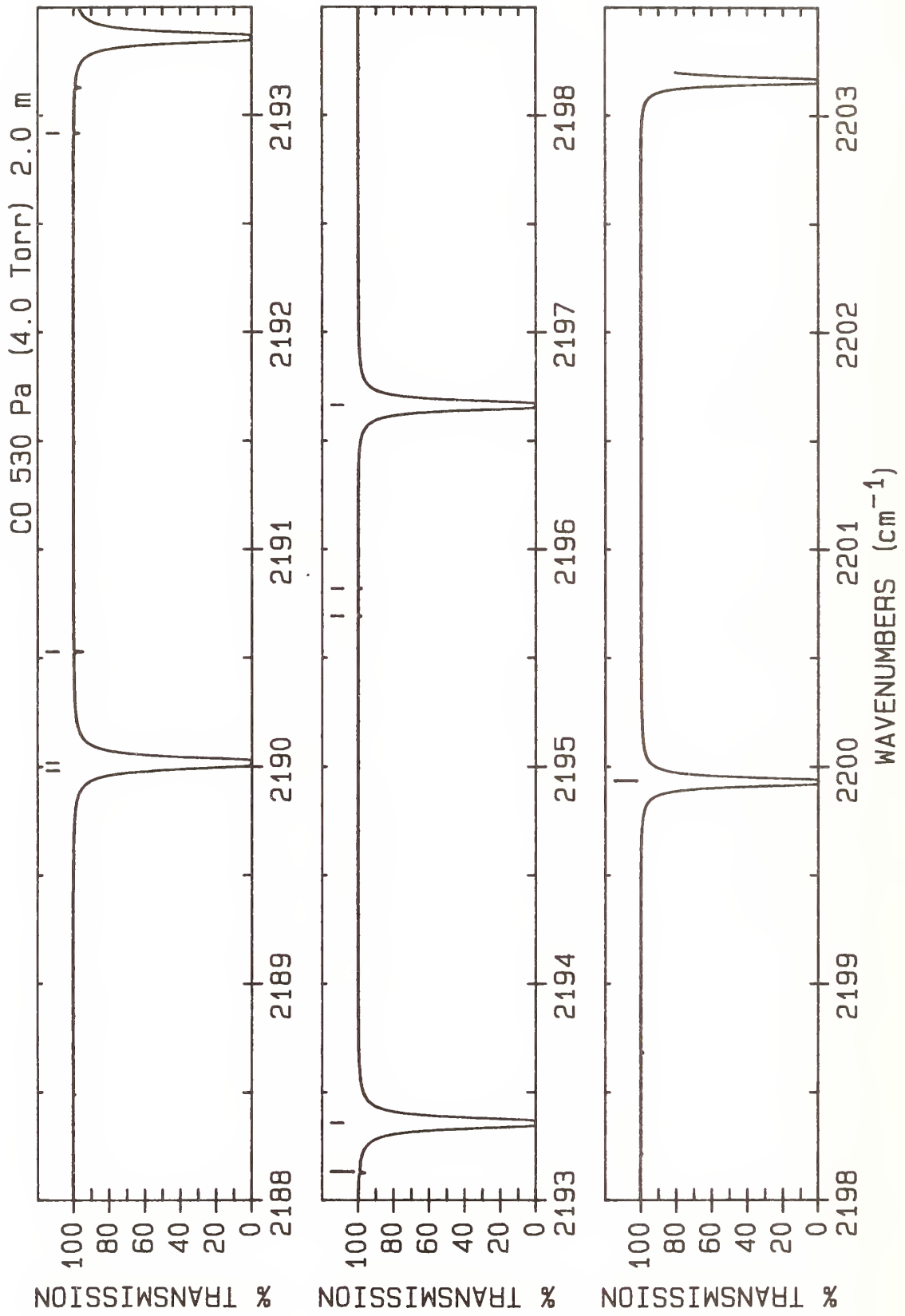

LINE #	WAVENUMBER(unc) (cm^{-1})	ROTATIONAL ASSIGNMENT	Mol.	INTENSITY ($\text{cm}/\text{molecule}$)
1	2189.979 7	R(21)	4	0.114E-22
2	2190.017 562(3)*	R(12)	1	0.292E-18
3	2190.528 9	R(29)	2	0.130E-22
4	2192.917 6	R(22)	4	0.802E-23
5	2193.128 4	R(30)	2	0.790E-23
6	2193.359 157(3)*	R(13)	1	0.247E-18
7	2195.691 0	R(31)	2	0.471E-23
8	2195.818 6	R(23)	4	0.552E-23
9	2196.663 692(4)*	R(14)	1	0.204E-18
10	2199.931 022(4)*	R(15)	1	0.165E-18

molecular species identification: 1-¹²C¹⁶O, 2-¹³C¹⁶O, 3-¹²C¹⁸O, 3-¹²C¹⁷O, 4-¹²C¹⁷O, 4-¹²C¹⁸O, 5-¹³C¹⁸O, 6-¹³C¹⁷O, 7-¹²C¹⁶O ($\nu = 2-1$)

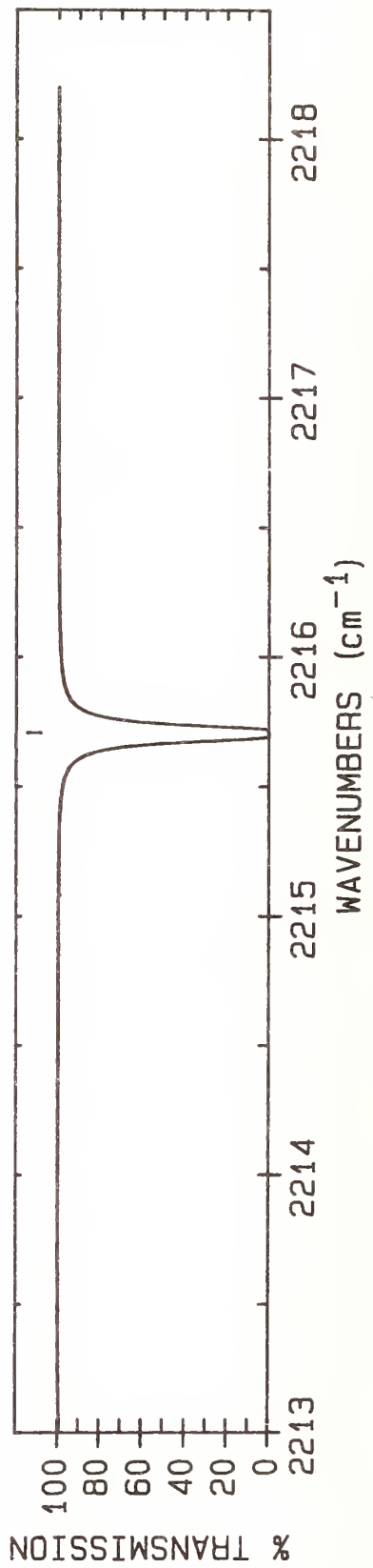
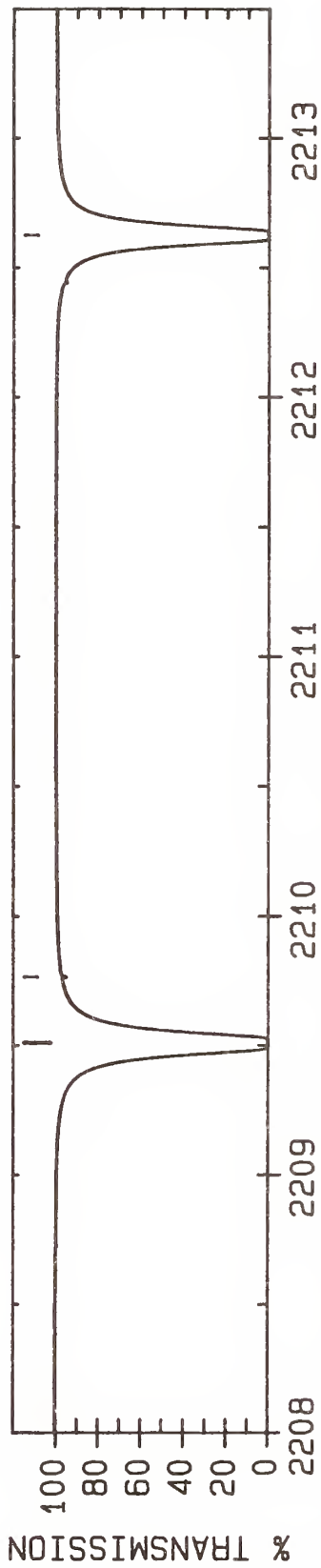
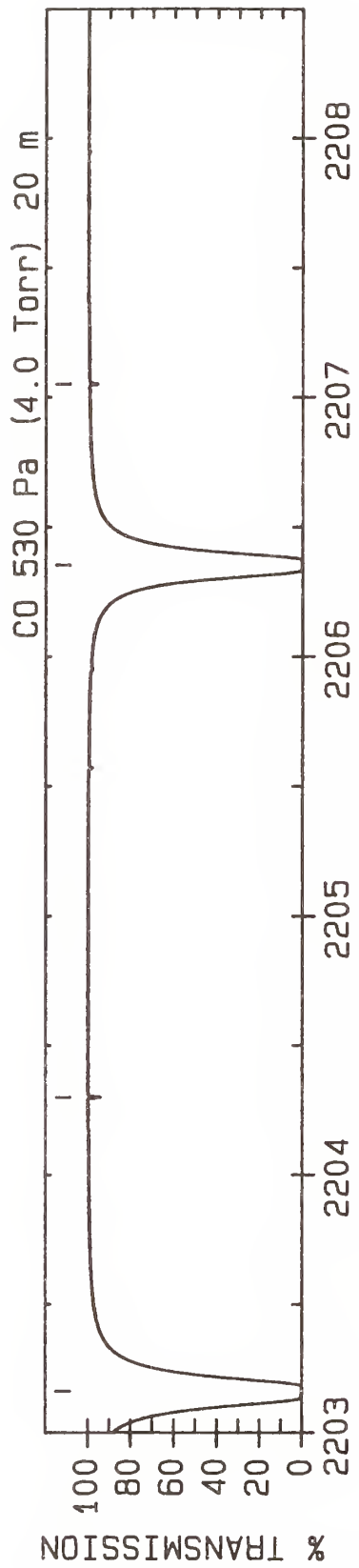

LINE #	WAVENUMBER(unc) (cm ⁻¹)	ROTATIONAL ASSIGNMENT	Mol.	INTENSITY (cm/molecule)
1	2203.161 000(5)*	R(16)	1	0.130E-18
2	2204.299 0	R(26)	4	0.160E-23
3	2206.353 481(6)*	R(17)	1	0.100E-18
4	2207.051 1	R(27)	4	0.102E-23
5	2209.508 317(7)*	R(18)	1	0.759E-19
6	2209.765 6	R(28)	4	0.634E-24
7	2212.625 363(9)*	R(19)	1	0.561E-19
8	2215.704 473(10)*	R(20)	1	0.407E-19

molecular species identification: 1-¹²C¹⁶O, 2-¹³C¹⁶O, 3-¹²C¹⁸O, 4-¹²C¹⁷O, 5-¹³C¹⁸O, 6-¹³C¹⁷O, 7-¹²C¹⁶O (v = 2-1)

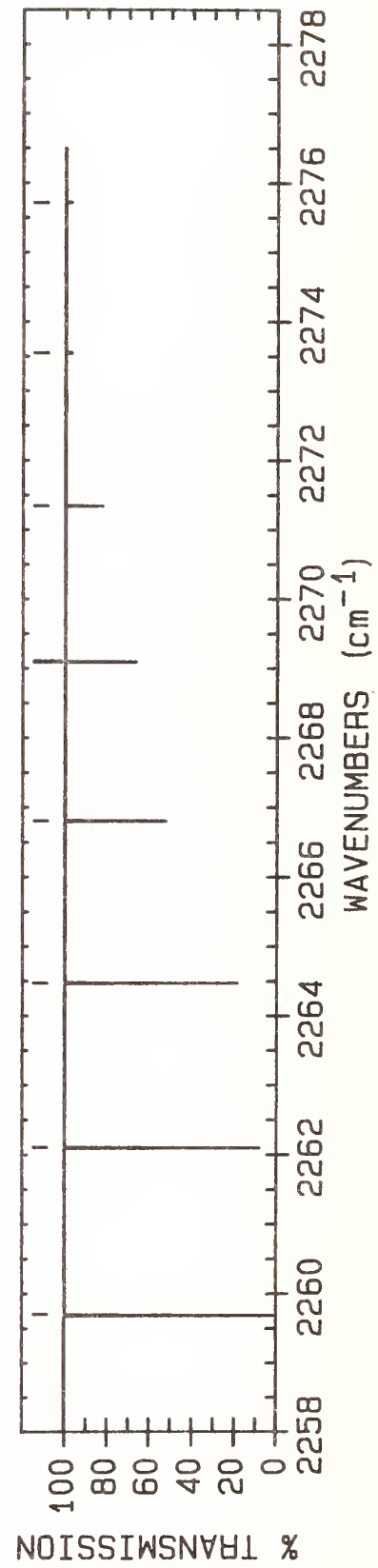
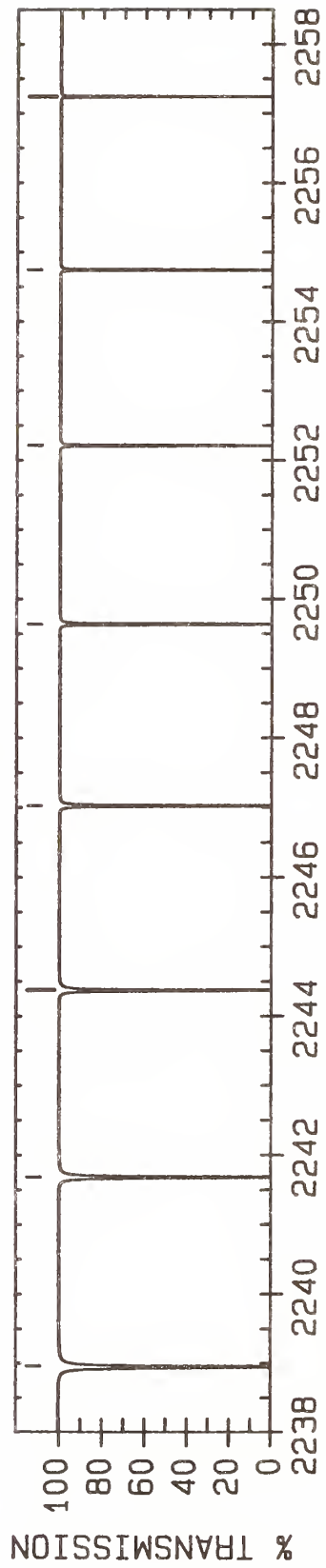
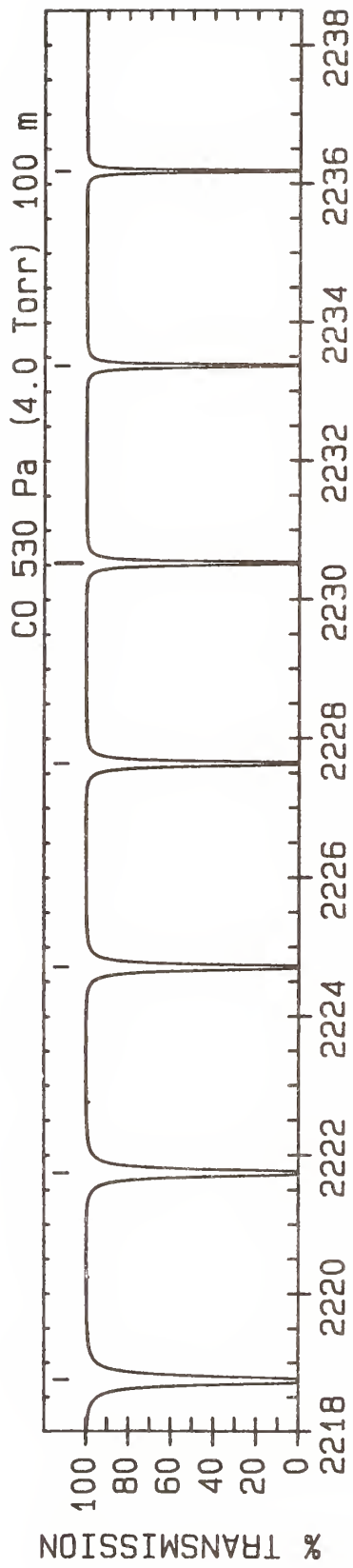

LINE #	WAVENUMBER(unc) (cm ⁻¹)	ROTATIONAL ASSIGNMENT	Mol.	INTENSITY (cm/molecule)
1	2218.745 501(11)*	R(21)	1	0.288E-19
2	2221.748 302(12)*	R(22)	1	0.200E-19
3	2224.712 729(14)*	R(23)	1	0.136E-19
4	2227.638 638(15)*	R(24)	1	0.910E-20
5	2230.525 881(16)*	R(25)	1	0.595E-20
6	2233.374 315(18)*	R(26)	1	0.381E-20
7	2236.183 793(19)*	R(27)	1	0.240E-20
8	2238.954 171(21)*	R(28)	1	0.148E-20
9	2241.685 302(23)*	R(29)	1	0.892E-21
10	2244.377 043(25)*	R(30)	1	0.528E-21
11	2247.029 247(27)*	R(31)	1	0.307E-21
12	2249.641 771(29)*	R(32)	1	0.175E-21
13	2252.214 47(3)*	R(33)	1	0.978E-22
14	2254.747 20(4)*	R(34)	1	0.536E-22
15	2257.239 81(4)*	R(35)	1	0.289E-22
16	2259.692 16(5)*	R(36)	1	0.152E-22
17	2262.104 10(5)*	R(37)	1	0.789E-23
18	2264.475 50(6)*	R(38)	1	0.401E-23
19	2266.806 20(6)*	R(39)	1	0.200E-23
20	2269.096 07(7)*	R(40)	1	0.980E-24
21	2271.344 95(8)*	R(41)	1	0.471E-24
22	2273.552 71(8)*	R(42)	1	0.222E-24
23	2275.719 20(9)*	R(43)	1	0.103E-24

molecular species identification: 1-¹²C¹⁶O, 2-¹³C¹⁶O, 3-¹²C¹⁸O, 4-¹²C¹⁷O, 5-¹³C¹⁸O, 6-¹³C¹⁷O, 7-¹²C¹⁶O (v = 2-1)

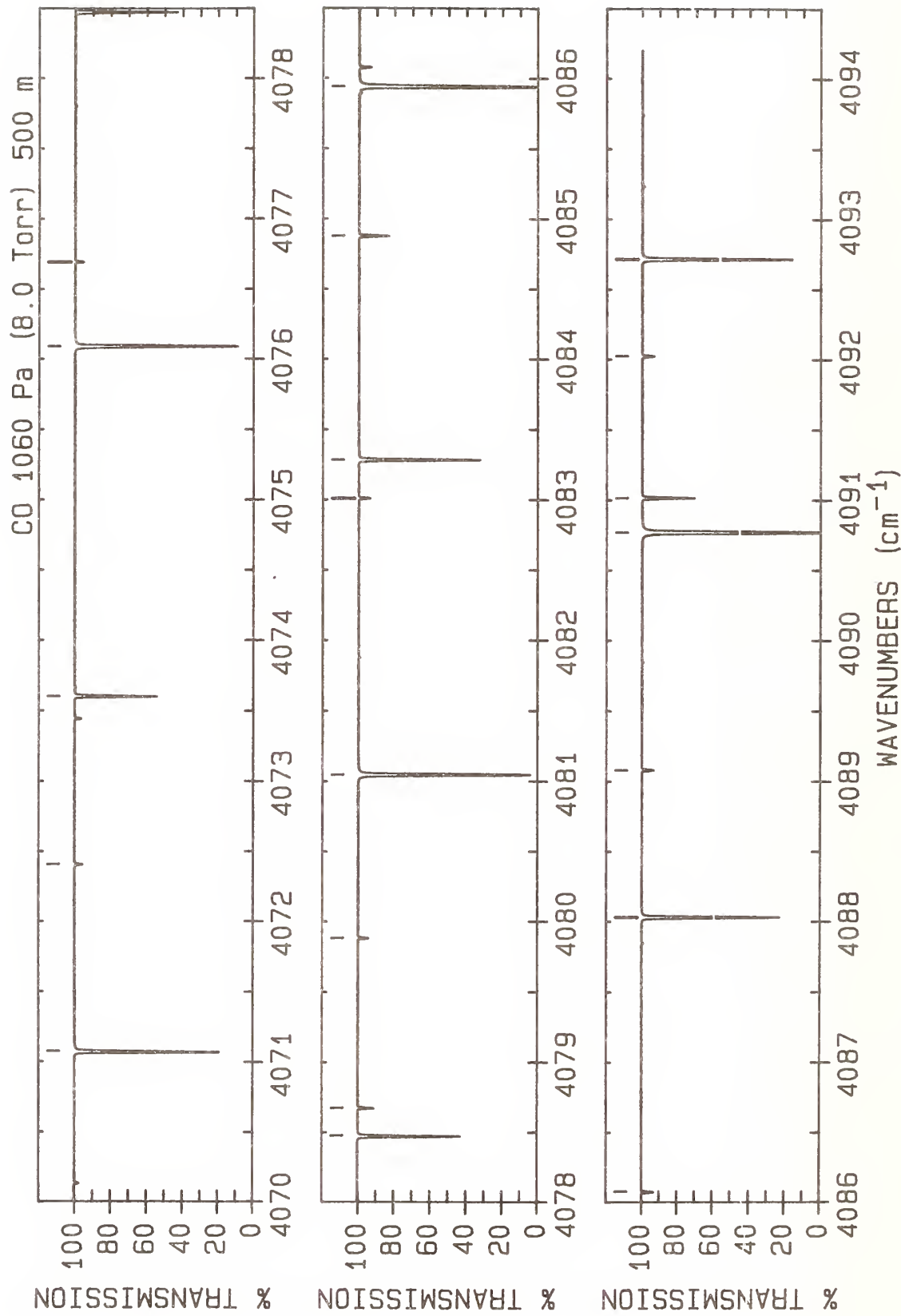

LINE #	WAVENUMBER(unc) (cm ⁻¹)	ROTATIONAL ASSIGNMENT	Mol.	INTENSITY (cm/molecule)
1	4071.071 8	P(22)	2	0.152E-23
2	4072.407 67(10)*	P(37)	1	0.451E-25
3	4073.602 1	P(20)	3	0.550E-24
4	4076.090 7	P(21)	2	0.215E-23
5	4076.694 7	R(3)	5	0.472E-25
6	4078.474 9	P(19)	3	0.749E-24
7	4078.675 43(9)*	P(36)	1	0.875E-25
8	4079.883 3	R(4)	5	0.555E-25
9	4081.047 1	P(20)	2	0.299E-23
10	4083.010 7	R(5)	5	0.615E-25
11	4083.285 1	P(18)	3	0.100E-23
12	4084.878 44(8)*	P(35)	1	0.167E-24
13	4085.940 7	P(19)	2	0.408E-23
14	4086.076 8	R(6)	5	0.652E-25
15	4088.032 6	P(17)	3	0.131E-23
16	4089.081 5	R(7)	5	0.666E-25
17	4090.771 5	P(18)	2	0.546E-23
18	4091.016 55(7)*	P(34)	1	0.311E-24
19	4092.024 6	R(8)	5	0.658E-25
20	4092.717 4	P(16)	3	0.167E-23

molecular species identification: 1-¹²C¹⁶O, 2-¹³C¹⁶O, 3-¹²C¹⁸O, 4-¹²C¹⁷O, 5-¹³C¹⁸O

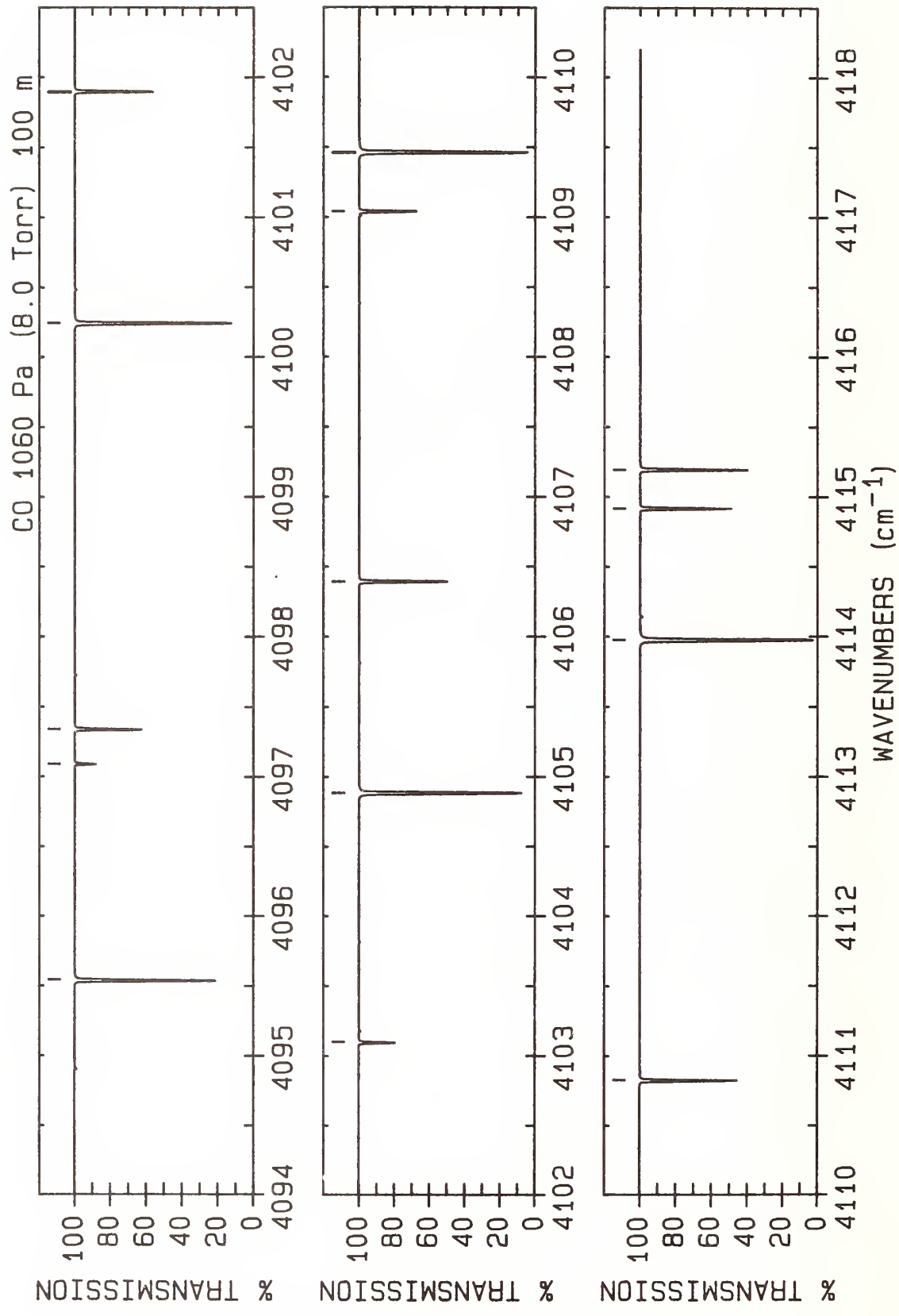

LINE #	WAVENUMBER(unc) (cm^{-1})	ROTATIONAL ASSIGNMENT	Mol.	INTENSITY (cm/molecule)
1	4095.539 2	P(17)	2	0.714E-23
2	4097.089 63(6)*	P(33)	1	0.570E-24
3	4097.339 2	P(15)	3	0.210E-23
4	4100.243 7	P(16)	2	0.915E-23
5	4101.897 9	P(14)	3	0.257E-23
6	4103.097 52(5)*	P(32)	1	0.102E-23
7	4104.885 0	P(15)	2	0.115E-22
8	4106.393 5	P(13)	3	0.307E-23
9	4109.040 08(4)*	P(31)	1	0.181E-23
10	4109.462 9	P(14)	2	0.141E-22
11	4110.825 7	P(12)	3	0.360E-23
12	4113.977 2	P(13)	2	0.169E-22
13	4114.917 17(4)*	P(30)	1	0.312E-23
14	4115.194 5	P(11)	3	0.410E-23

molecular species identification: 1- $^{12}\text{C}^{16}\text{O}$, 2- $^{13}\text{C}^{16}\text{O}$, 3- $^{12}\text{C}^{18}\text{O}$, 4- $^{12}\text{C}^{17}\text{O}$, 5- $^{13}\text{C}^{18}\text{O}$

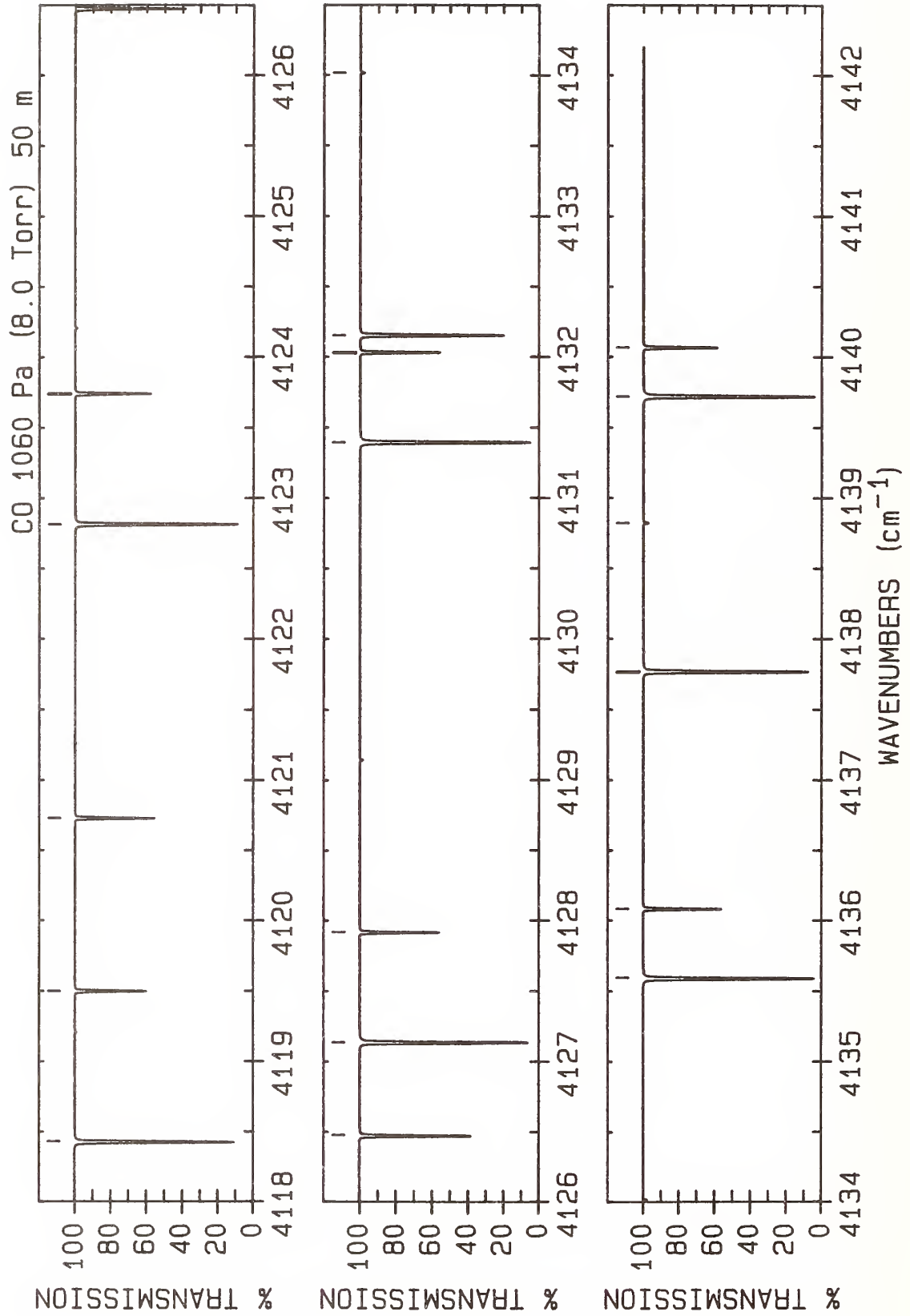

LINE #	WAVENUMBER(unc) (cm ⁻¹)	ROTATIONAL ASSIGNMENT	Mol.	INTENSITY (cm/molecule)
1	4118.427 8	P(12)	2	0.198E-22
2	4119.499 7	P(10)	3	0.456E-23
3	4120.728 64(3)*	P(29)	1	0.530E-23
4	4122.814 6	P(11)	2	0.226E-22
5	4123.741 2	P(9)	3	0.493E-23
6	4126.474 350(26)*	P(28)	1	0.881E-23
7	4127.137 5	P(10)	2	0.251E-22
8	4127.918 8	P(8)	3	0.517E-23
9	4131.396 2	P(9)	2	0.271E-22
10	4132.032 4	P(7)	3	0.525E-23
11	4132.154 153(22)*	P(27)	1	0.144E-22
12	4134.016 7	P(17)	4	0.237E-24
13	4135.590 8	P(8)	2	0.285E-22
14	4136.081 9	P(6)	3	0.513E-23
15	4137.767 902(18)*	P(26)	1	0.230E-22
16	4138.823 5	P(16)	4	0.306E-24
17	4139.721 0	P(7)	2	0.289E-22
18	4140.067 1	P(5)	3	0.478E-23

molecular species identification: 1-¹²C¹⁶O, 2-¹³C¹⁶O, 3-¹²C¹⁸O, 4-¹²C¹⁷O, 5-¹³C¹⁸O

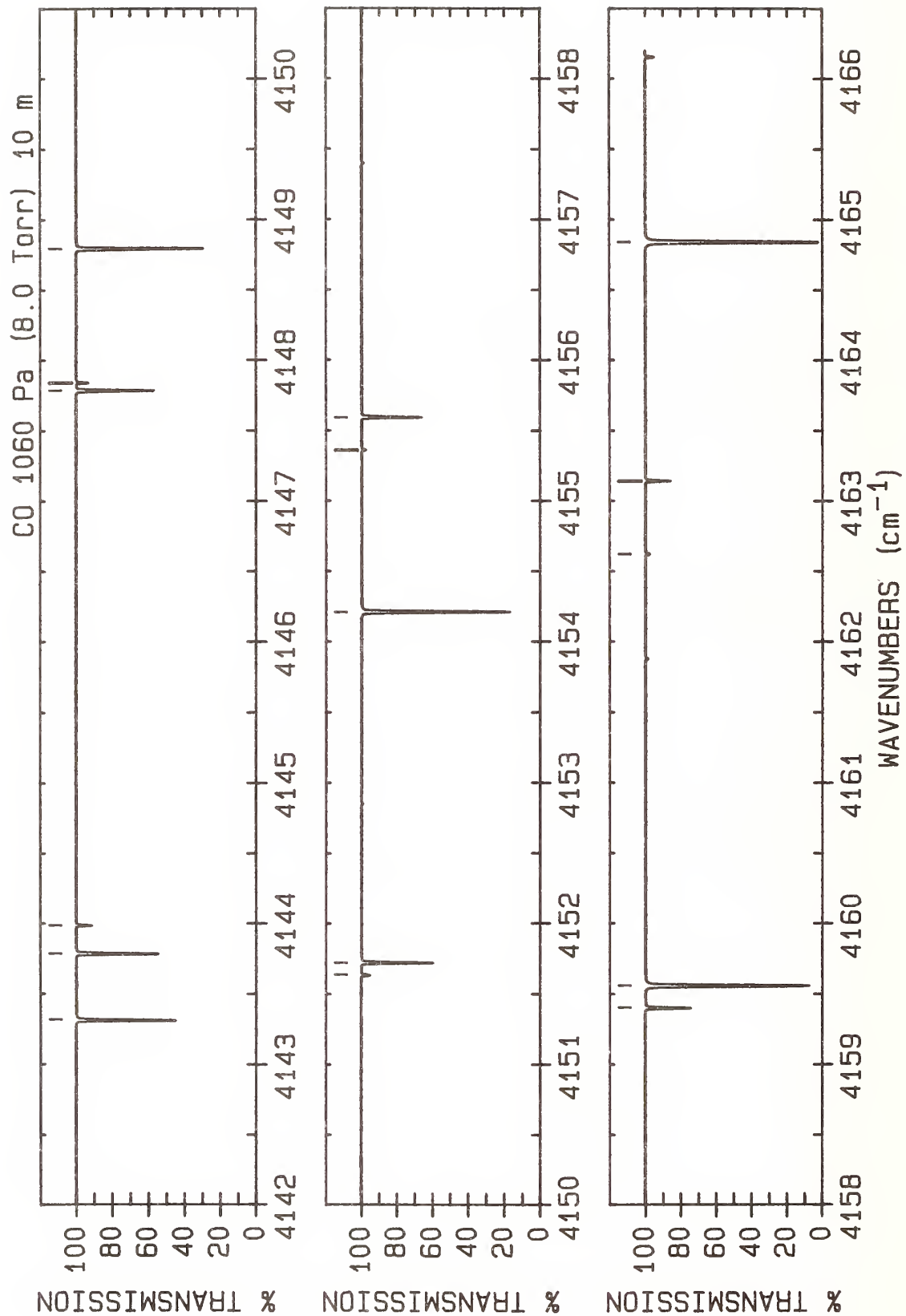

LINE #	WAVENUMBER(unc) (cm^{-1})	ROTATIONAL ASSIGNMENT	Mol.	INTENSITY ($\text{cm}/\text{molecule}$)
1	4143.315 454(15)*	P(25)	1	0.360E-22
2	4143.786 7	P(6)	2	0.283E-22
3	4143.988 0	P(4)	3	0.420E-23
4	4147.787 7	P(5)	2	0.264E-22
5	4147.844 3	P(3)	3	0.341E-23
6	4148.796 662(13)*	P(24)	1	0.554E-22
7	4151.635 9	P(2)	3	0.241E-23
8	4151.724 0	P(4)	2	0.232E-22
9	4154.211 380(10)*	P(23)	1	0.834E-22
10	4155.362 8	P(1)	3	0.125E-23
11	4155.595 4	P(3)	2	0.188E-22
12	4159.401 8	P(2)	2	0.133E-22
13	4159.559 463(9)*	P(22)	1	0.123E-21
14	4162.621 6	R(0)	3	0.129E-23
15	4163.143 0	P(1)	2	0.693E-23
16	4164.840 765(7)*	P(21)	1	0.178E-21

molecular species identification: 1-¹²C¹⁶O, 2-¹³C¹⁶O, 3-¹²C¹⁸O, 4-¹²C¹⁷O, 5-¹³C¹⁸O

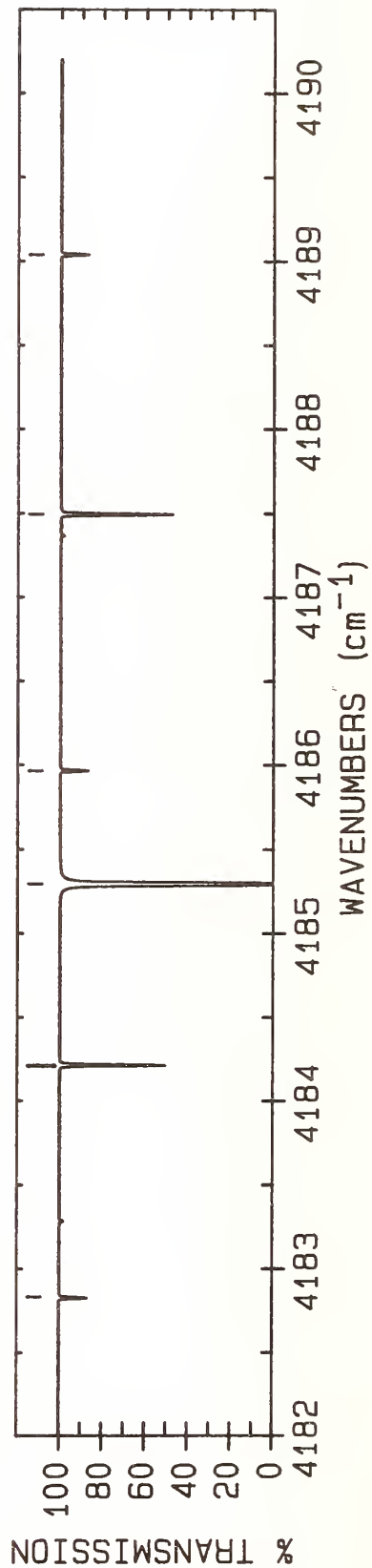
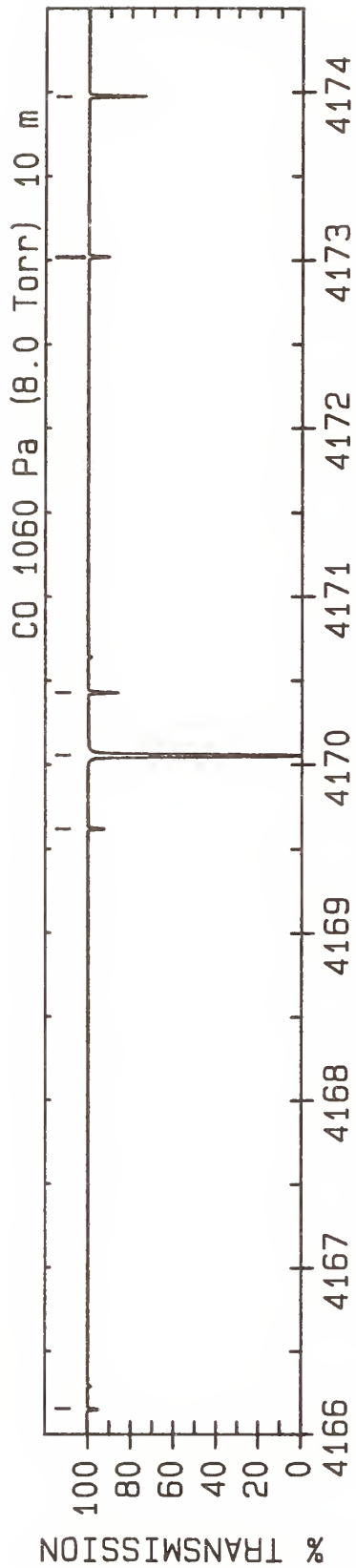

LINE #	WAVENUMBER(unc) (cm ⁻¹)	ROTATIONAL ASSIGNMENT	Mol.	INTENSITY (cm/molecule)
1	4166.153 3	R(1)	3	0.255E-23
2	4169.619 7	R(2)	3	0.372E-23
3	4170.055 139(6)*	P(20)	1	0.252E-21
4	4170.429 4	R(0)	2	0.714E-23
5	4173.020 6	R(3)	3	0.473E-23
6	4173.974 4	R(1)	2	0.141E-22
7	4175.202 440(6)*	P(19)	1	0.349E-21
8	4176.355 9	R(4)	3	0.554E-23
9	4177.453 6	R(2)	2	0.205E-22
10	4179.136 9	P(7)	4	0.100E-23
11	4179.625 5	R(5)	3	0.612E-23
12	4180.282 521(5)*	P(18)	1	0.474E-21
13	4180.867 0	R(3)	2	0.261E-22
14	4182.829 2	R(6)	3	0.645E-23
15	4184.214 4	R(4)	2	0.306E-22
16	4185.295 235(4)*	P(17)	1	0.629E-21
17	4185.967 0	R(7)	3	0.655E-23
18	4187.495 7	R(5)	2	0.338E-22
19	4189.038 6	R(8)	3	0.643E-23

molecular species identification: 1-¹²C¹⁶O, 2-¹³C¹⁶O, 3-¹²C¹⁸O, 4-¹²C¹⁷O, 5-¹³C¹⁸O

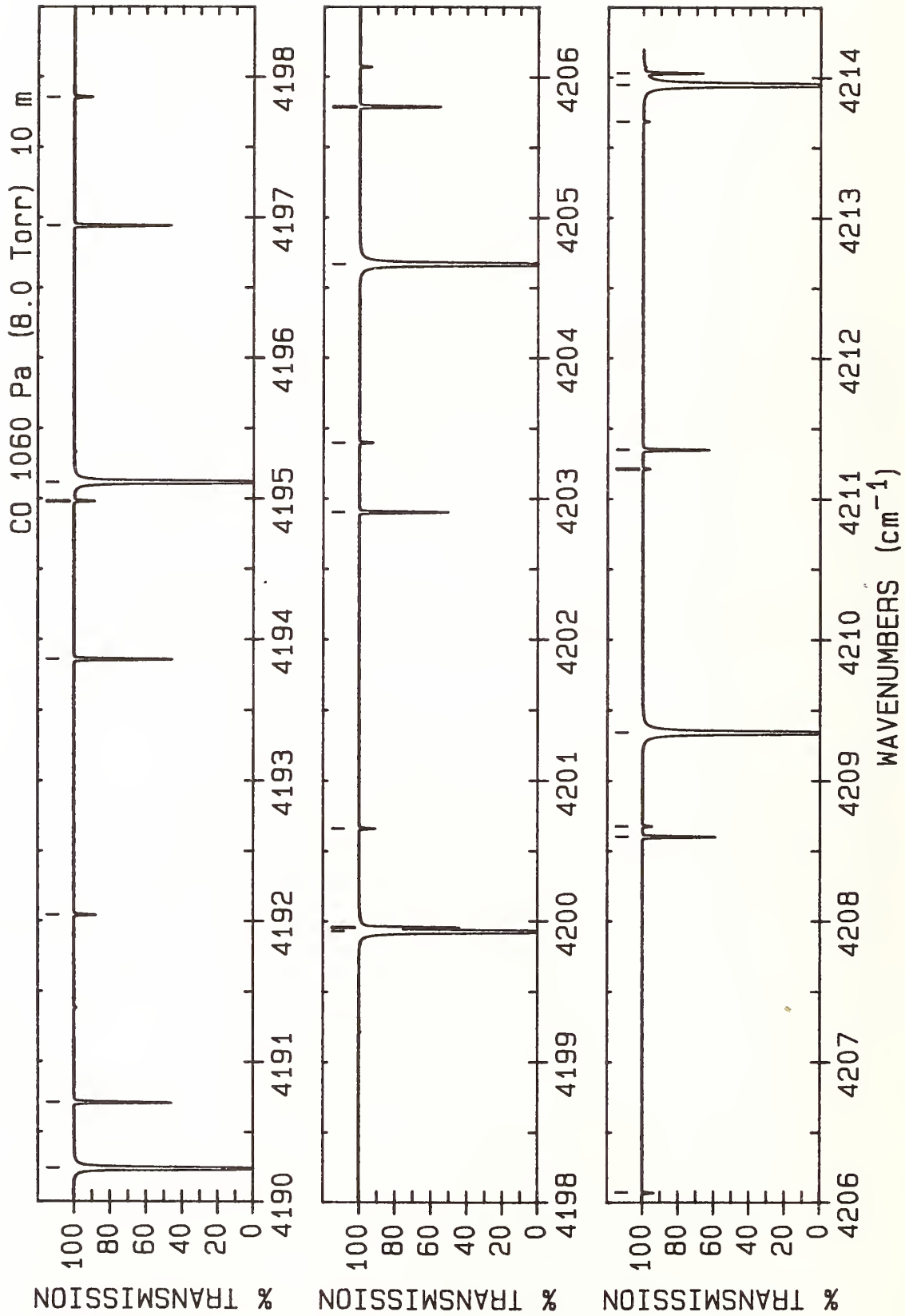

LINE #	WAVENUMBER(unc) (cm ⁻¹)	ROTATIONAL ASSIGNMENT	Mol.	INTENSITY (cm/molecule)
1	4190.240 437(4)*	P(16)	1	0.818E-21
2	4190.710 8	R(6)	2	0.356E-22
3	4192.044 0	R(9)	3	0.613E-23
4	4193.859 5	R(7)	2	0.361E-22
5	4194.983 0	R(10)	3	0.567E-23
6	4195.117 979(4)*	P(15)	1	0.104E-20
7	4196.941 7	R(8)	2	0.354E-22
8	4197.855 4	R(11)	3	0.512E-23
9	4199.927 715(3)*	P(14)	1	0.129E-20
10	4199.957 3	R(9)	2	0.337E-22
11	4200.661 2	R(12)	3	0.451E-23
12	4202.906 1	R(10)	2	0.312E-22
13	4203.400 3	R(13)	3	0.388E-23
14	4204.669 499(3)*	P(13)	1	0.156E-20
15	4205.788 0	R(11)	2	0.282E-22
16	4206.072 4	R(14)	3	0.326E-23
17	4208.602 9	R(12)	2	0.248E-22
18	4208.677 4	R(15)	3	0.268E-23
19	4209.343 183(3)*	P(12)	1	0.185E-20
20	4211.215 3	R(16)	3	0.216E-23
21	4211.350 6	R(13)	2	0.213E-22
22	4213.685 8	R(17)	3	0.170E-23
23	4213.948 621(2)*	P(11)	1	0.214E-20
24	4214.030 9	R(14)	2	0.179E-22

molecular species identification: 1-¹²C¹⁶O, 2-¹³C¹⁶O, 3-¹²C¹⁸O, 4-¹²C¹⁷O, 5-¹³C¹⁸O

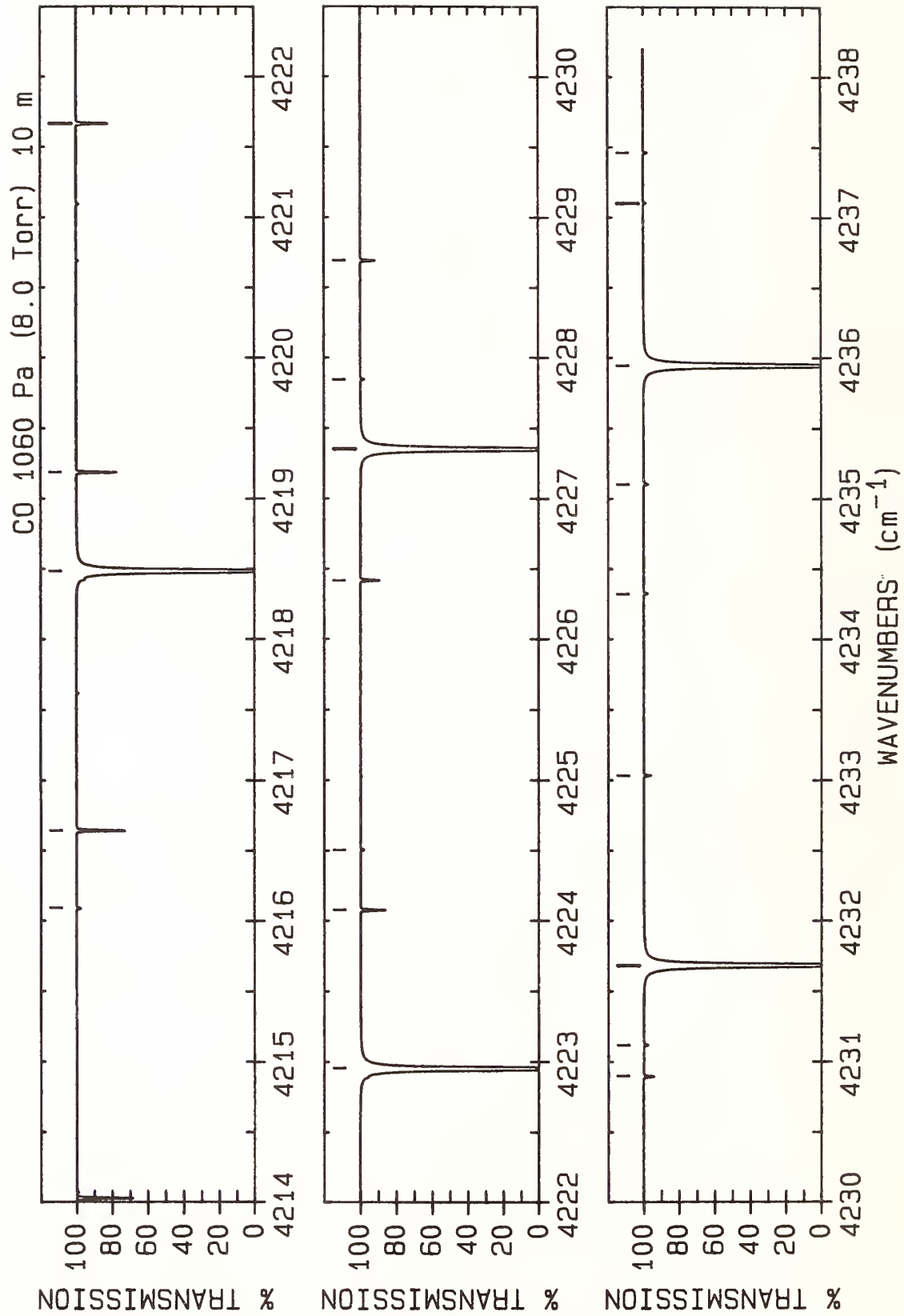

LINE #	WAVENUMBER(unc) (cm ⁻¹)	ROTATIONAL ASSIGNMENT	Mol.	INTENSITY (cm/molecule)
1	4216.088 9	R(18)	3	0.131E-23
2	4216.643 9	R(15)	2	0.147E-22
3	4218.485 666(2)*	P(10)	1	0.240E-20
4	4219.189 2	R(16)	2	0.118E-22
5	4221.666 9	R(17)	2	0.928E-23
6	4222.954 170(2)*	P(9)	1	0.262E-20
7	4224.076 7	R(18)	2	0.715E-23
8	4224.505 3	R(4)	4	0.107E-23
9	4226.418 5	R(19)	2	0.540E-23
10	4227.353 988(2)*	P(8)	1	0.277E-20
11	4227.846 9	R(5)	4	0.118E-23
12	4228.692 3	R(20)	2	0.399E-23
13	4230.897 7	R(21)	2	0.290E-23
14	4231.120 3	R(6)	4	0.124E-23
15	4231.684 973(2)*	P(7)	1	0.282E-20
16	4233.034 9	R(22)	2	0.206E-23
17	4234.325 4	R(7)	4	0.125E-23
18	4235.103 5	R(23)	2	0.144E-23
19	4235.946 976(2)*	P(6)	1	0.278E-20
20	4237.103 4	R(24)	2	0.982E-24
21	4237.461 9	R(8)	4	0.123E-23

molecular species identification: 1-¹²C¹⁶O, 2-¹³C¹⁶O, 3-¹²C¹⁸O, 4-¹²C¹⁷O, 5-¹³C¹⁸O.

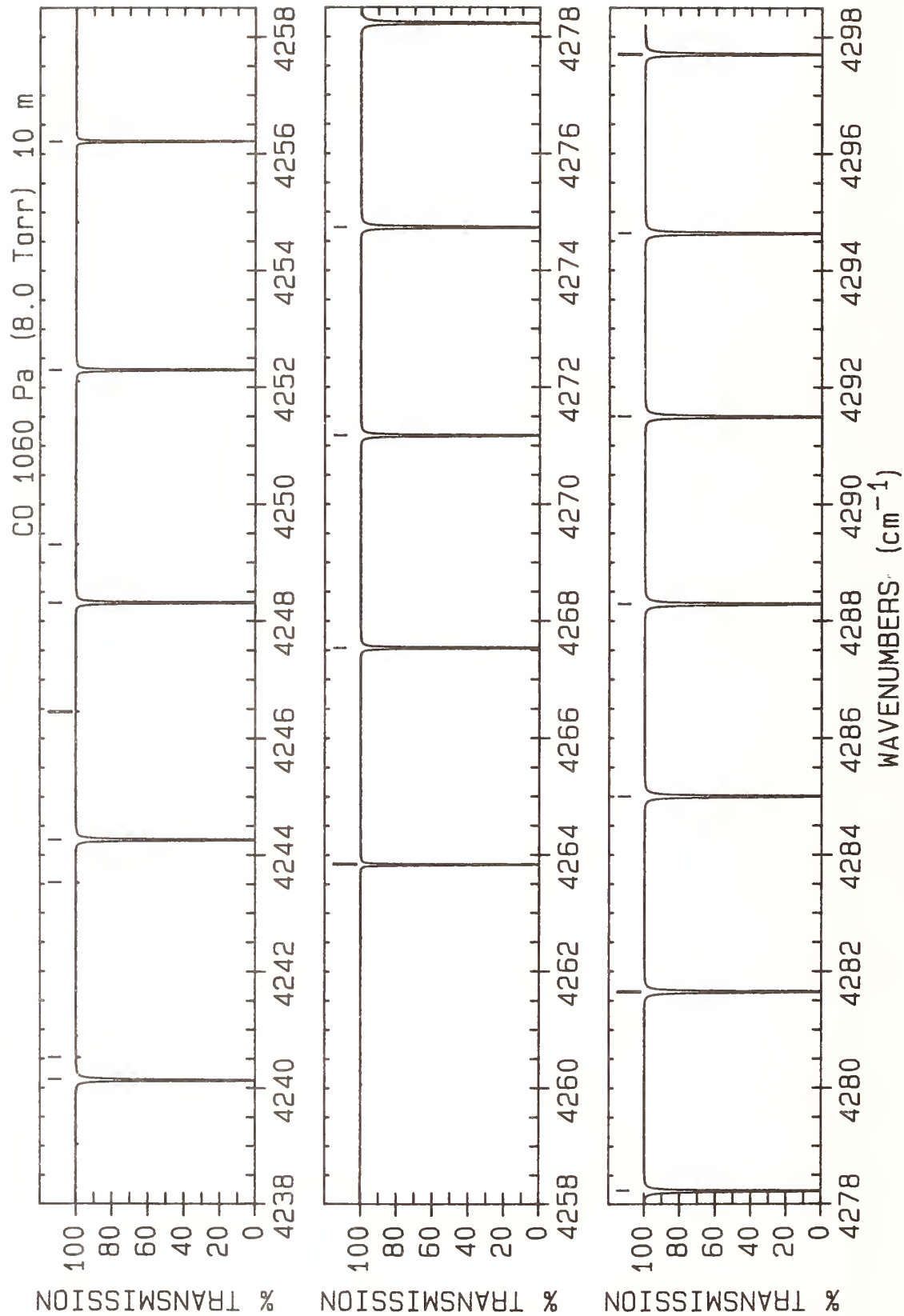

LINE #	WAVENUMBER(unc) (cm ⁻¹)	ROTATIONAL ASSIGNMENT	Mol.	INTENSITY (cm/molecule)
1	4240.139 852(2)*	P(5)	1	0.260E-20
2	4240.529 9	R(9)	4	0.116E-23
3	4243.529 1	R(10)	4	0.107E-23
4	4244.263 453(2)*	P(4)	1	0.230E-20
5	4246.459 4	R(11)	4	0.965E-24
6	4248.317 633(2)*	P(3)	1	0.187E-20
7	4249.320 6	R(12)	4	0.846E-24
8	4252.302 244(3)*	P(2)	1	0.133E-20
9	4256.217 140(3)*	P(1)	1	0.692E-21
10	4263.837 198(3)*	R(0)	1	0.713E-21
11	4267.542 066(2)*	R(1)	1	0.141E-20
12	4271.176 631(2)*	R(2)	1	0.205E-20
13	4274.740 746(2)*	R(3)	1	0.260E-20
14	4278.234 265(2)*	R(4)	1	0.303E-20
15	4281.657 040(2)*	R(5)	1	0.333E-20
16	4285.008 925(2)*	R(6)	1	0.350E-20
17	4288.289 773(2)*	R(7)	1	0.353E-20
18	4291.499 438(2)*	R(8)	1	0.344E-20
19	4294.637 773(2)*	R(9)	1	0.325E-20
20	4297.704 631(3)*	R(10)	1	0.298E-20

molecular species identification: 1-¹²C¹⁶O, 2-¹³C¹⁶O, 3-¹²C¹⁸O, 4-¹²C¹⁷O, 5-¹³C¹⁸O

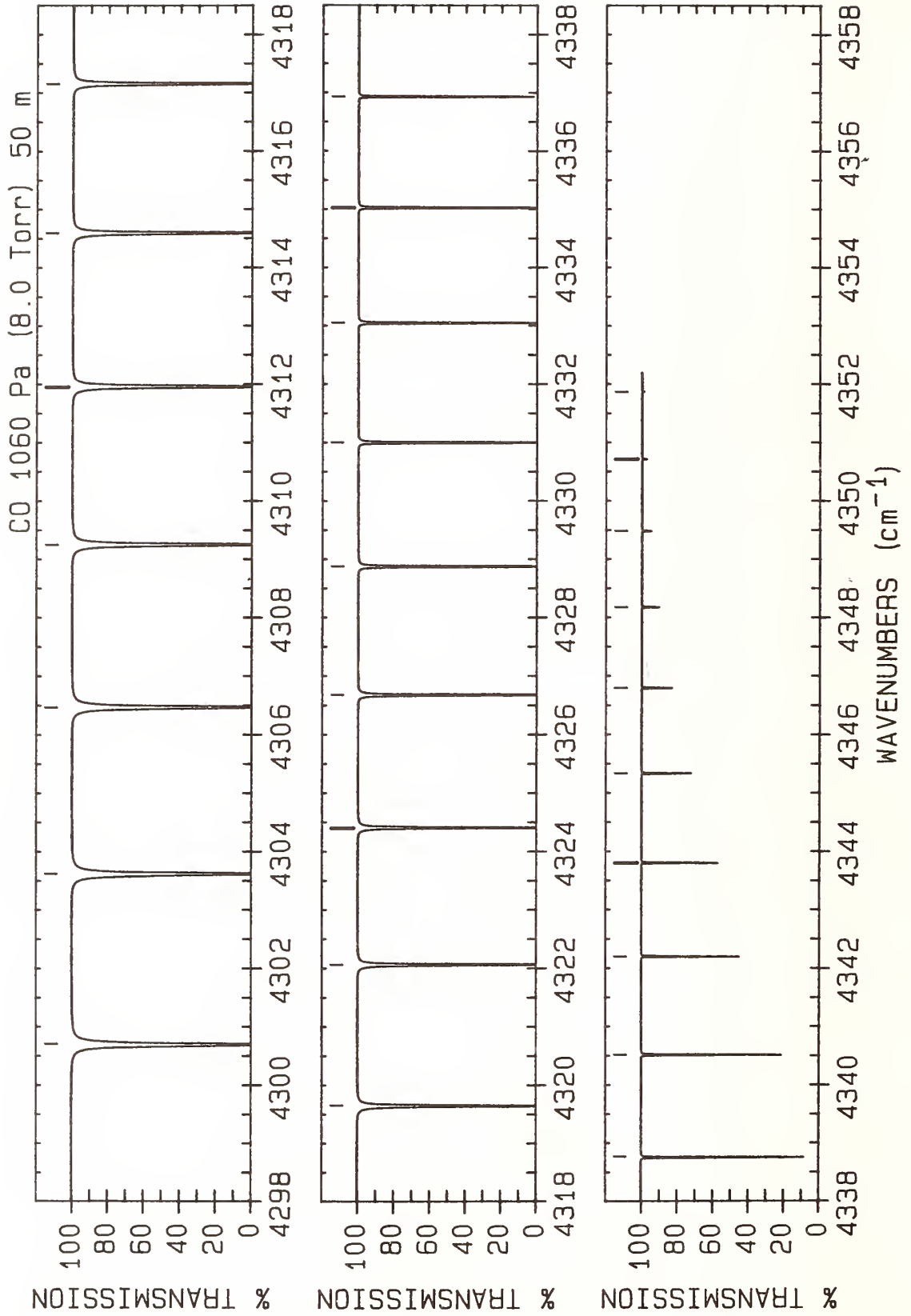

LINE #	WAVENUMBER(unc) (cm^{-1})	ROTATIONAL ASSIGNMENT	Mol.	INTENSITY ($\text{cm}^2/\text{molecule}$)
1	4300.699 867(3)*	R(11)	1	0.267E-20
2	4303.623 333(3)*	R(12)	1	0.232E-20
3	4306.474 883(4)*	R(13)	1	0.197E-20
4	4309.254 372(4)*	R(14)	1	0.164E-20
5	4311.961 652(4)*	R(15)	1	0.133E-20
6	4314.596 577(5)*	R(16)	1	0.106E-20
7	4317.159 002(6)*	R(17)	1	0.819E-21
8	4319.648 781(6)*	R(18)	1	0.622E-21
9	4322.065 766(7)*	R(19)	1	0.462E-21
10	4324.409 813(9)*	R(20)	1	0.336E-21
11	4326.680 776(10)*	R(21)	1	0.240E-21
12	4328.878 508(13)*	R(22)	1	0.167E-21
13	4331.002 864(15)*	R(23)	1	0.115E-21
14	4333.053 698(18)*	R(24)	1	0.768E-22
15	4335.030 865(22)*	R(25)	1	0.504E-22
16	4336.934 219(26)*	R(26)	1	0.325E-22
17	4338.763 614(31)*	R(27)	1	0.205E-22
18	4340.518 91(4)*	R(28)	1	0.127E-22
19	4342.199 95(4)*	R(29)	1	0.771E-23
20	4343.806 59(5)*	R(30)	1	0.459E-23
21	4345.338 70(6)*	R(31)	1	0.268E-23
22	4346.796 12(7)*	R(32)	1	0.154E-23
23	4348.178 71(8)*	R(33)	1	0.864E-24
24	4349.486 32(9)*	R(34)	1	0.476E-24
25	4350.718 82(10)*	R(35)	1	0.258E-24
26	4351.876 04(11)*	R(36)	1	0.137E-24

molecular species identification: 1- $^{12}\text{C}^{16}\text{O}$, 2- $^{13}\text{C}^{16}\text{O}$, 3- $^{12}\text{C}^{18}\text{O}$, 4- $^{12}\text{C}^{17}\text{O}$, 5- $^{13}\text{C}^{18}\text{O}$

Energy Levels for OCS

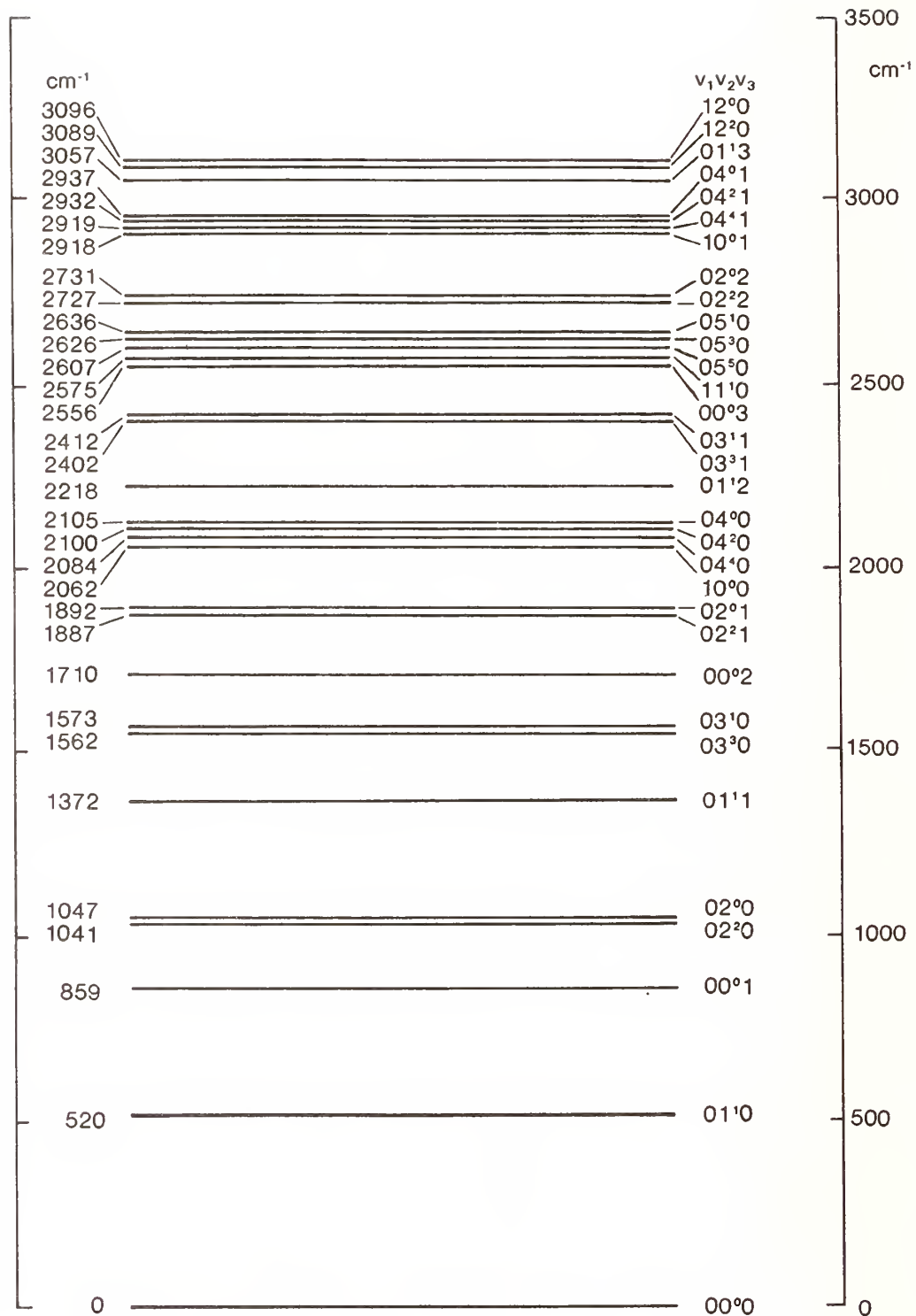

ATLAS OF OCS ABSORPTION LINES FROM 486 cm⁻¹ to 567 cm⁻¹

key:

Band	Isotopomer	Vibrational Transition
A	¹⁶ O ¹² C ³² S	01 ¹ 0-00 ⁰ 0
B		02 ² 0-01 ^{1e} 0
C		02 ² 0-01 ^{1f} 0
D		01 ¹ 1-00 ⁰ 1
E		03 ³ 0-02 ^{2e} 0
F		03 ³ 0-02 ^{2f} 0
G		03 ¹ 0-02 ⁰ 0
H		02 ⁰ 0-01 ¹ 0
I		03 ¹ 0-02 ^{2e} 0
J		03 ¹ 0-02 ^{2f} 0
P	¹⁶ O ¹² C ³⁴ S	01 ¹ 0-00 ⁰ 0
Q		02 ² 0-01 ^{1e} 0
R		02 ² 0-01 ^{1f} 0
S		02 ⁰ 0-01 ¹ 0
T	¹⁶ O ¹³ C ³² S	01 ¹ 0-00 ⁰ 0

If the e or f designation is not specified (for $l \neq 0$), then the transition is to either level, depending on the selection rules and the change in the rotational quantum number, J . Spectra are given for a slitwidth of 0.002 cm⁻¹ and a transition moment of 0.047 debye at a temperature of 296 K. A Herman-Wallis constant of $C_1 = 0.0045$ is included in the intensity calculation for the lines of all bands.

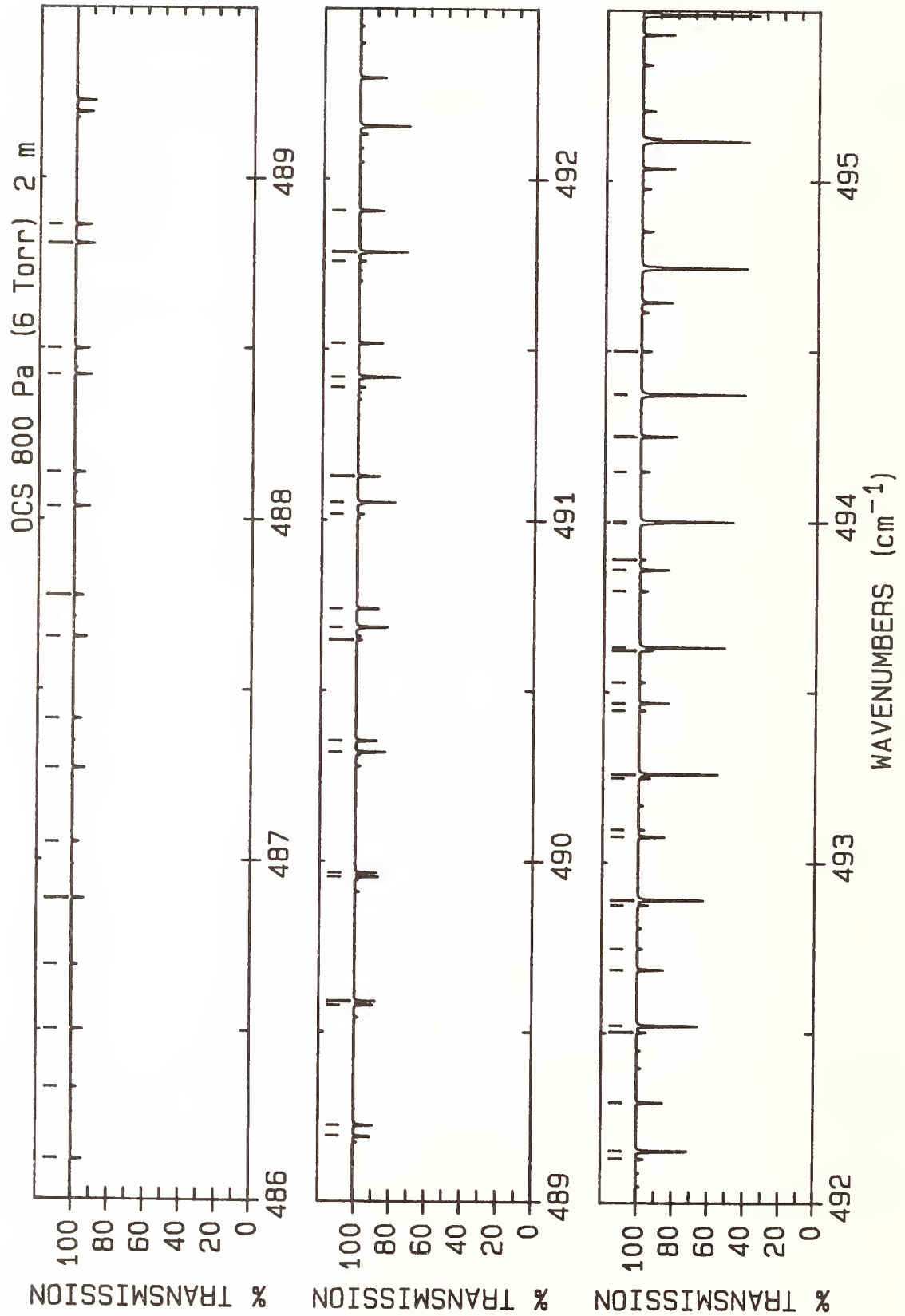

LINE #	WAVENUMBER(unc) (cm ⁻¹)	LOWER STATE (cm ⁻¹)	INTENSITY (cm/molecule)	ASSIGNMENT ROTATION BAND	LINE #	WAVENUMBER(unc) (cm ⁻¹)	LOWER STATE (cm ⁻¹)	INTENSITY (cm/molecule)	ASSIGNMENT ROTATION BAND
1	486.120 97(47)	475.34	0.628E-23	P(48) T	36	491.906 60(15)	226.81	0.158E-22	P(33) T
2	486.332 35(17)	1622.09	0.310E-23	P(89) A	37	492.130 52(15)	1481.48	0.479E-23	P(55) D
3	486.503 30(43)	455.95	0.680E-23	P(47) T	38	492.153 69(15)*	1094.56	0.375E-22	P(73) A
4	486.692 21(17)	1586.11	0.368E-23	P(88) A	39	492.296 14(14)	213.47	0.164E-22	P(32) T
5	486.886 12(40)	436.96	0.734E-23	P(46) T	40	492.502 58(15)	1459.26	0.527E-23	P(54) D
6	487.052 61(17)	1550.52	0.436E-23	P(87) A	41	492.522 03(15)*	1065.01	0.430E-22	P(72) A
7	487.269 42(37)	418.37	0.791E-23	P(45) T	42	492.686 17(13)	200.54	0.170E-22	P(31) T
8	487.413 53(16)	1515.34	0.516E-23	P(86) A	43	492.746 97(25)	1676.68	0.309E-23	P(75) B
9	487.653 20(34)	400.19	0.850E-23	P(44) T	44	492.875 25(15)	1437.44	0.579E-23	P(53) D
10	487.774 98(16)*	1480.56	0.609E-23	P(85) A	45	492.889 38(25)	1587.83	0.330E-23	P(72) C
11	488.037 47(32)	382.41	0.911E-23	P(43) T	46	492.890 90(15)*	1035.86	0.492E-22	P(71) A
12	488.136 96(16)*	1446.18	0.717E-23	P(84) A	47	493.076 67(12)	188.01	0.176E-22	P(30) T
13	488.422 22(29)	365.03	0.974E-23	P(42) T	48	493.096 54(25)	1646.29	0.353E-23	P(74) B
14	488.499 47(16)*	1412.20	0.842E-23	P(83) A	49	493.248 53(15)	1416.03	0.634E-23	P(52) D
15	488.807 45(27)	348.06	0.104E-22	P(41) T	50	493.259 59(25)	1558.61	0.378E-23	P(71) C
16	488.862 50(16)*	1378.63	0.987E-23	P(82) A	51	493.260 30(15)*	1007.12	0.562E-22	P(70) A
17	489.193 16(25)	331.49	0.110E-22	P(40) T	52	493.446 57(25)	1616.30	0.403E-23	P(73) B
18	489.226 07(16)*	1345.45	0.115E-22	P(81) A	53	493.467 64(11)	175.88	0.181E-22	P(29) T
19	489.579 36(23)	315.33	0.117E-22	P(39) T	54	493.528 91(19)	954.88	0.310E-23	P(69) P
20	489.590 17(15)*	1312.68	0.135E-22	P(80) A	55	493.622 42(15)	1395.02	0.693E-23	P(51) D
21	489.954 80(15)*	1280.32	0.157E-22	P(79) A	56	493.630 23(15)*	978.78	0.640E-22	P(69) A
22	489.966 03(22)	299.57	0.124E-22	P(38) T	57	493.630 33(25)	1529.81	0.431E-23	P(70) C
23	490.319 95(15)*	1248.35	0.182E-22	P(78) A	58	493.797 08(25)	1586.71	0.459E-23	P(72) B
24	490.353 19(20)	284.21	0.131E-22	P(37) T	59	493.859 09(10)	164.16	0.186E-22	P(28) T
25	490.648 36(16)	1574.38	0.318E-23	P(59) D	60	493.890 03(18)	927.62	0.352E-23	P(68) P
26	490.685 64(15)*	1216.79	0.212E-22	P(77) A	61	493.996 91(15)	1374.42	0.756E-23	P(50) D
27	490.740 82(19)	269.25	0.138E-22	P(36) T	62	494.000 69(15)*	950.84	0.728E-22	P(68) A
28	491.017 99(16)	1550.55	0.354E-23	P(58) D	63	494.001 59(25)	1501.40	0.491E-23	P(69) C
29	491.051 86(15)*	1185.63	0.245E-22	P(76) A	64	494.148 06(25)	1557.53	0.522E-23	P(71) B
30	491.128 93(17)	254.70	0.144E-22	P(35) T	65	494.251 01(10)	152.84	0.190E-22	P(27) T
31	491.388 22(16)	1527.12	0.392E-23	P(57) D	66	494.251 67(17)	900.76	0.398E-23	P(67) P
32	491.418 60(15)*	1154.87	0.283E-22	P(75) A	67	494.371 68(15)*	923.31	0.826E-22	P(67) A
33	491.517 53(16)	240.56	0.151E-22	P(34) T	68	494.372 02(15)	1354.21	0.823E-23	P(49) D
34	491.759 07(16)	1504.10	0.434E-23	P(56) D	69	494.373 38(25)	1473.40	0.559E-23	P(68) C
35	491.785 88(15)*	1124.51	0.326E-22	P(74) A	70	494.499 54(25)	1528.76	0.592E-23	P(70) B

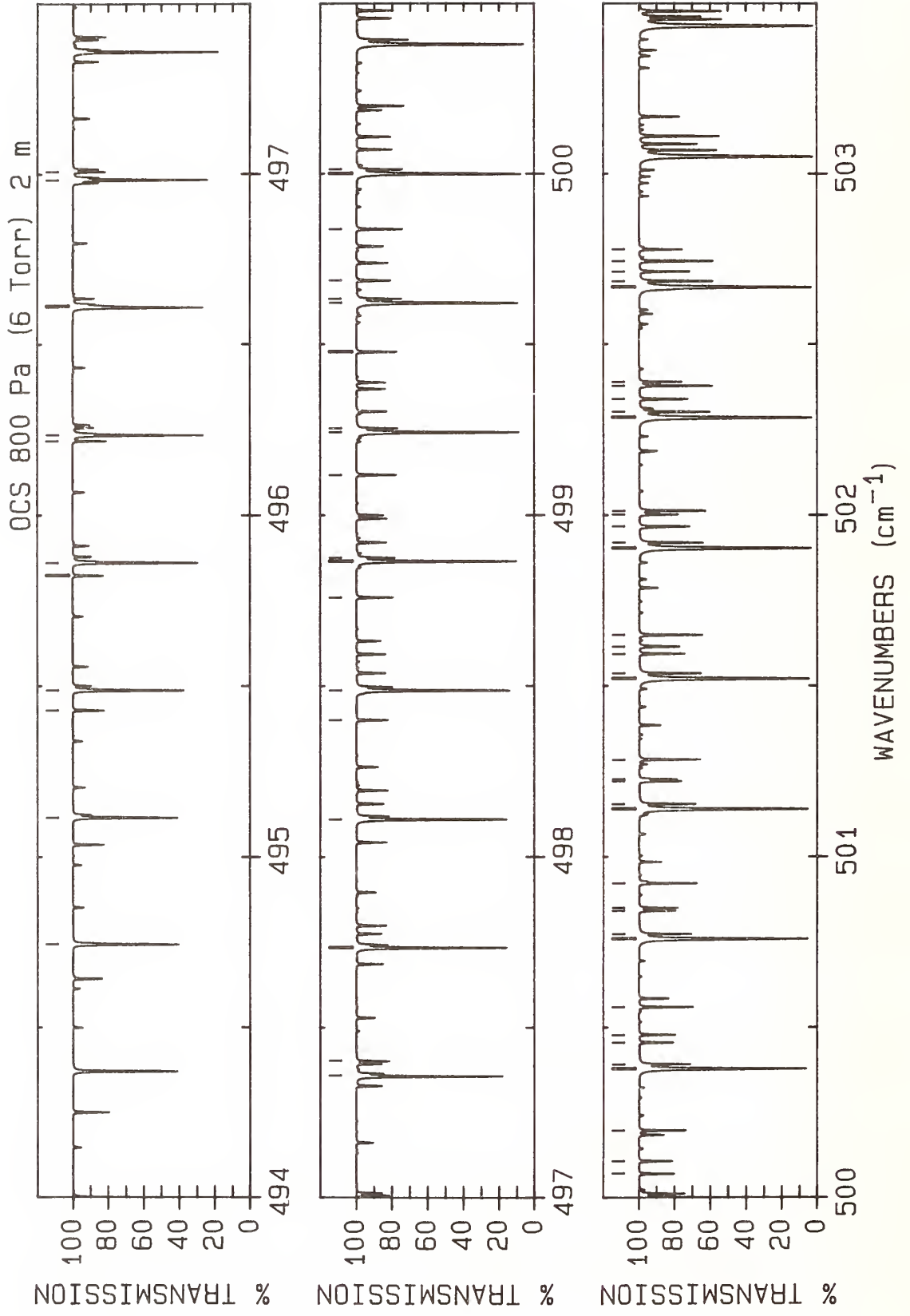

LINE #	WAVENUMBER(unc) (cm ⁻¹)	LOWER STATE (cm ⁻¹)	INTENSITY (cm/molecule)	ASSIGNMENT ROTATION BAND	LINE #	WAVENUMBER(unc) (cm ⁻¹)	LOWER STATE (cm ⁻¹)	INTENSITY (cm/molecule)	ASSIGNMENT ROTATION BAND
1	494.743 21(15)*	896.18	0.935E-22	P(66) A	36	500.393 33(26)	1080.42	0.319E-22	P(52) C
2	495.115 26(15)*	869.46	0.106E-21	P(65) A	37	500.456 38(15)	1085.84	0.224E-22	P(33) D
3	495.429 61(8)	121.31	0.200E-22	P(24) T	38	500.479 27(7)	504.37	0.229E-22	P(50) P
4	495.487 84(15)*	843.13	0.119E-21	P(64) A	39	500.560 35(26)	1101.34	0.354E-22	P(53) B
5	495.823 42(7)	111.60	0.202E-22	P(23) T	40	500.759 63(15)*	517.00	0.498E-21	P(50) A
6	495.860 96(15)*	817.21	0.134E-21	P(63) A	41	500.774 03(26)	1059.31	0.349E-22	P(51) C
7	496.217 71(6)	102.30	0.203E-22	P(22) T	42	500.841 81(15)	1072.49	0.233E-22	P(32) D
8	496.234 60(15)*	791.70	0.150E-21	P(62) A	43	500.850 28(6)	484.60	0.248E-22	P(49) P
9	496.608 78(15)*	766.58	0.168E-21	P(61) A	44	500.922 51(26)	1079.84	0.386E-22	P(52) B
10	496.612 46(6)	93.41	0.203E-22	P(21) T	45	501.140 15(15)*	496.74	0.542E-21	P(49) A
11	496.983 48(15)*	741.87	0.188E-21	P(60) A	46	501.155 25(26)	1038.59	0.380E-22	P(50) C
12	497.007 67(5)	84.92	0.202E-22	P(20) T	47	501.221 81(6)	465.23	0.269E-22	P(48) P
13	497.358 71(15)*	717.57	0.209E-21	P(59) A	48	501.227 85(15)	1059.56	0.242E-22	P(31) D
14	497.403 36(5)	76.83	0.200E-22	P(19) T	49	501.285 37(26)	1058.74	0.419E-22	P(51) B
15	497.734 48(15)*	693.67	0.232E-21	P(58) A	50	501.521 20(15)*	476.88	0.589E-21	P(48) A
16	498.110 77(15)*	670.17	0.258E-21	P(57) A	51	501.536 99(26)	1018.28	0.413E-22	P(49) C
17	498.401 34(25)	1238.86	0.203E-22	P(59) B	52	501.593 85(6)	446.25	0.290E-22	P(47) P
18	498.487 59(15)*	647.08	0.285E-21	P(56) A	53	501.614 49(15)	1047.02	0.250E-22	P(30) D
19	498.759 57(25)	1214.93	0.224E-22	P(58) B	54	501.648 92(26)	1038.05	0.453E-22	P(50) B
20	498.864 94(15)*	624.39	0.315E-21	P(55) A	55	501.902 78(15)*	457.42	0.637E-21	P(47) A
21	498.875 77(26)	1168.96	0.218E-22	P(56) C	56	501.919 25(27)	998.38	0.448E-22	P(48) C
22	499.118 42(26)	1191.40	0.247E-22	P(57) B	57	501.966 42(6)	427.66	0.313E-22	P(46) P
23	499.242 82(15)*	602.10	0.347E-21	P(54) A	58	502.001 74(15)	1034.89	0.258E-22	P(29) D
24	499.254 38(26)	1146.22	0.241E-22	P(55) C	59	502.013 19(26)	1017.76	0.490E-22	P(49) B
25	499.477 91(26)	1168.28	0.271E-22	P(56) B	60	502.284 88(15)*	438.37	0.689E-21	P(46) A
26	499.621 23(15)*	580.22	0.381E-21	P(53) A	61	502.302 04(27)	978.88	0.485E-22	P(47) C
27	499.633 51(26)	1123.88	0.265E-22	P(54) C	62	502.339 50(5)	409.47	0.336E-22	P(45) P
28	499.687 33(15)	1113.73	0.205E-22	P(35) D	63	502.378 17(26)	997.88	0.528E-22	P(48) B
29	499.838 06(26)	1145.56	0.297E-22	P(55) B	64	502.389 59(15)	1023.17	0.265E-22	P(28) D
30	500.000 17(15)*	558.74	0.417E-21	P(52) A	65	502.667 51(15)*	419.73	0.742E-21	P(45) A
31	500.013 16(26)	1101.95	0.291E-22	P(53) C	66	502.685 34(27)	959.78	0.524E-22	P(46) C
32	500.071 55(15)	1099.58	0.215E-22	P(34) D	67	502.713 10(5)	391.68	0.361E-22	P(44) P
33	500.108 78(7)	524.53	0.210E-22	P(51) P	68	502.743 88(27)	978.40	0.568E-22	P(47) B
34	500.198 87(26)	1123.25	0.325E-22	P(54) B	69	502.778 05(15)	1011.84	0.271E-22	P(27) D
35	500.379 64(15)*	537.67	0.457E-21	P(51) A					

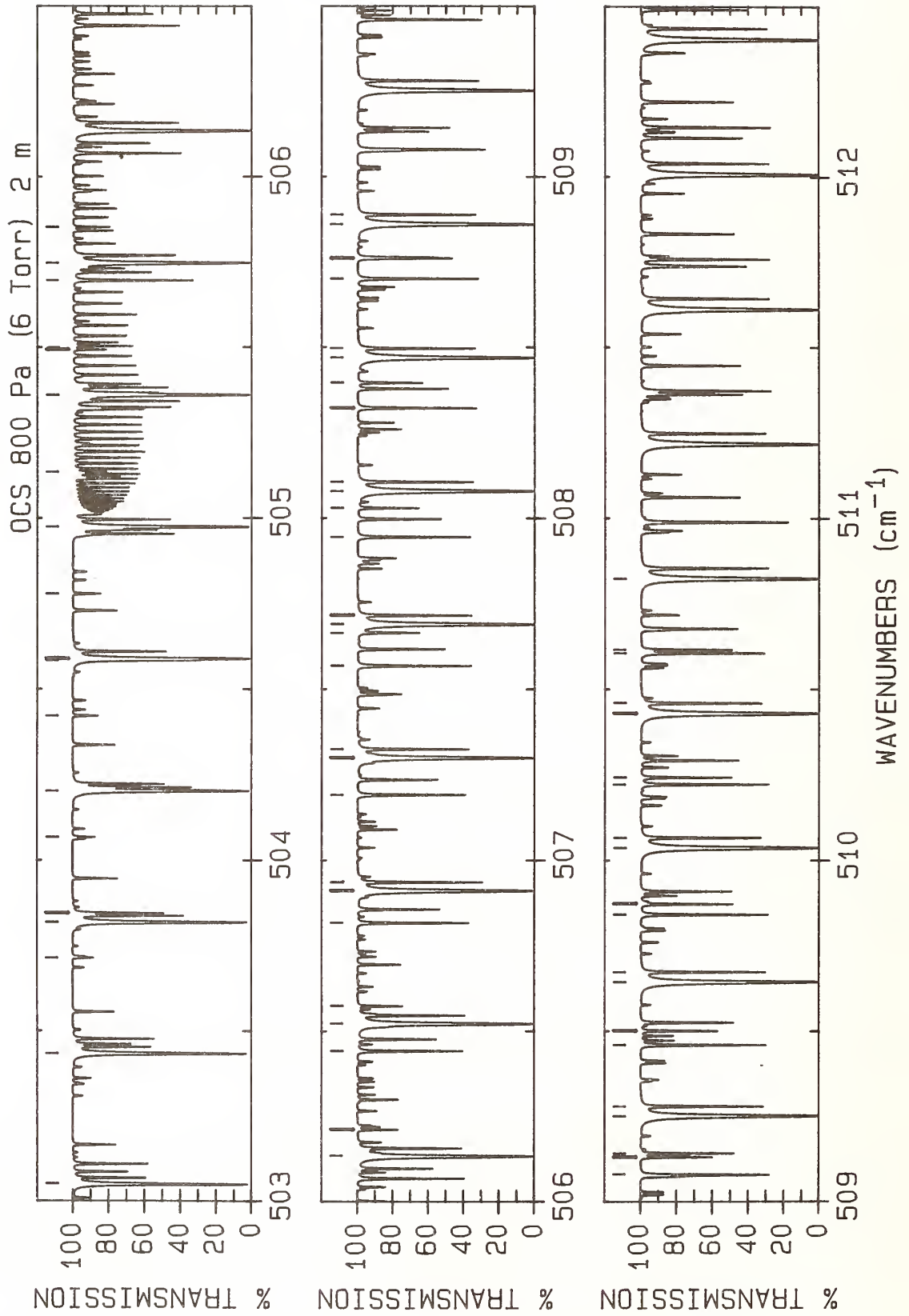

LINE #	WAVENUMBER(unc) (cm ⁻¹)	LOWER STATE (cm ⁻¹)	INTENSITY (cm/molecule)	ASSIGNMENT ROTATION BAND	LINE #	WAVENUMBER(unc) (cm ⁻¹)	LOWER STATE (cm ⁻¹)	INTENSITY (cm/molecule)	ASSIGNMENT ROTATION BAND
1	503.050 66(15)*	401.49	0.797E-21	P(44) A	36	507.944 88(28)	748.25	0.120E-21	P(33) B
2	503.434 34(15)*	383.65	0.855E-21	P(43) A	37	508.029 81(15)*	997.88	0.417E-22	P(48) H
3	503.714 47(15)*	1263.19	0.117E-22	P(60) H	38	508.079 35(15)*	201.19	0.160E-20	P(31) A
4	503.818 55(15)*	366.22	0.914E-21	P(42) A	39	508.106 06(28)	735.07	0.115E-21	P(32) C
5	503.845 48(27)	922.39	0.696E-22	P(44) B	40	508.322 46(28)	734.85	0.124E-21	P(32) B
6	504.068 07(15)*	1238.86	0.132E-22	P(59) H	41	508.396 25(15)*	978.40	0.456E-22	P(47) H
7	504.203 28(15)*	349.19	0.975E-21	P(41) A	42	508.469 82(15)*	188.62	0.165E-20	P(30) A
8	504.422 80(15)*	1214.93	0.148E-22	P(58) H	43	508.497 13(28)	722.07	0.119E-21	P(31) C
9	504.583 67(27)	887.08	0.788E-22	P(42) B	44	508.700 88(28)	721.86	0.128E-21	P(31) B
10	504.588 53(15)*	332.57	0.104E-20	P(40) A	45	508.760 69(4)	160.67	0.770E-22	P(28) P
11	504.778 65(15)*	1191.40	0.167E-22	P(57) H	46	508.763 69(15)*	959.33	0.496E-22	P(46) H
12	504.974 31(15)*	316.35	0.110E-20	P(39) A	47	508.860 81(15)*	176.45	0.170E-20	P(29) A
13	505.135 60(15)*	1168.28	0.186E-22	P(56) H	48	508.888 71(28)	709.47	0.123E-21	P(30) C
14	505.360 61(15)*	300.54	0.117E-20	P(38) A	49	509.080 15(28)	709.27	0.132E-21	P(30) B
15	505.493 65(15)*	1145.56	0.208E-22	P(55) H	50	509.132 13(15)*	940.66	0.540E-22	P(45) H
16	505.696 82(27)	837.16	0.930E-22	P(39) B	51	509.143 01(4)	149.59	0.788E-22	P(27) P
17	505.747 44(15)*	285.13	0.123E-20	P(37) A	52	509.252 32(15)*	164.69	0.175E-20	P(28) A
18	505.852 79(15)*	1123.25	0.231E-22	P(54) H	53	509.280 80(28)	697.27	0.127E-21	P(29) C
19	506.134 79(15)*	270.13	0.129E-20	P(36) A	54	509.460 27(28)	697.09	0.135E-21	P(29) B
20	506.213 00(15)*	1101.34	0.257E-22	P(53) H	55	509.501 55(15)*	922.39	0.585E-22	P(44) H
21	506.442 90(28)	805.90	0.102E-21	P(37) B	56	509.644 35(15)*	153.34	0.179E-20	P(27) A
22	506.522 66(15)*	255.53	0.136E-20	P(35) A	57	509.673 40(28)	685.49	0.130E-21	P(28) C
23	506.574 28(15)*	1079.84	0.285E-22	P(52) H	58	509.841 26(28)	685.31	0.138E-21	P(28) B
24	506.817 16(28)	790.88	0.107E-21	P(36) B	59	509.871 94(15)*	904.54	0.632E-22	P(43) H
25	506.911 05(15)*	241.34	0.142E-20	P(34) A	60	509.872 82(16)	877.17	0.178E-22	P(9) D
26	506.935 95(28)	776.53	0.102E-21	P(35) C	61	510.036 89(15)*	142.38	0.183E-20	P(26) A
27	506.936 61(15)*	1058.74	0.314E-22	P(51) H	62	510.066 52(28)	674.10	0.132E-21	P(27) C
28	507.192 24(28)	776.26	0.112E-21	P(35) B	63	510.223 10(28)	673.94	0.140E-21	P(27) B
29	507.299 96(15)*	227.55	0.148E-20	P(33) A	64	510.243 30(15)*	887.08	0.682E-22	P(42) H
30	507.299 98(15)*	1038.05	0.346E-22	P(50) H	65	510.429 95(15)*	131.84	0.186E-20	P(25) A
31	507.325 47(28)	762.31	0.107E-21	P(34) C	66	510.460 15(28)	663.13	0.135E-21	P(26) C
32	507.568 14(28)	762.05	0.116E-21	P(34) B	67	510.605 82(28)	662.98	0.142E-21	P(26) B
33	507.664 38(15)*	1017.76	0.380E-22	P(49) H	68	510.615 62(15)*	870.04	0.733E-22	P(41) H
34	507.689 40(15)*	214.17	0.154E-20	P(32) A	69	510.823 53(15)*	121.70	0.188E-20	P(24) A
35	507.715 51(28)	748.49	0.111E-21	P(33) C					

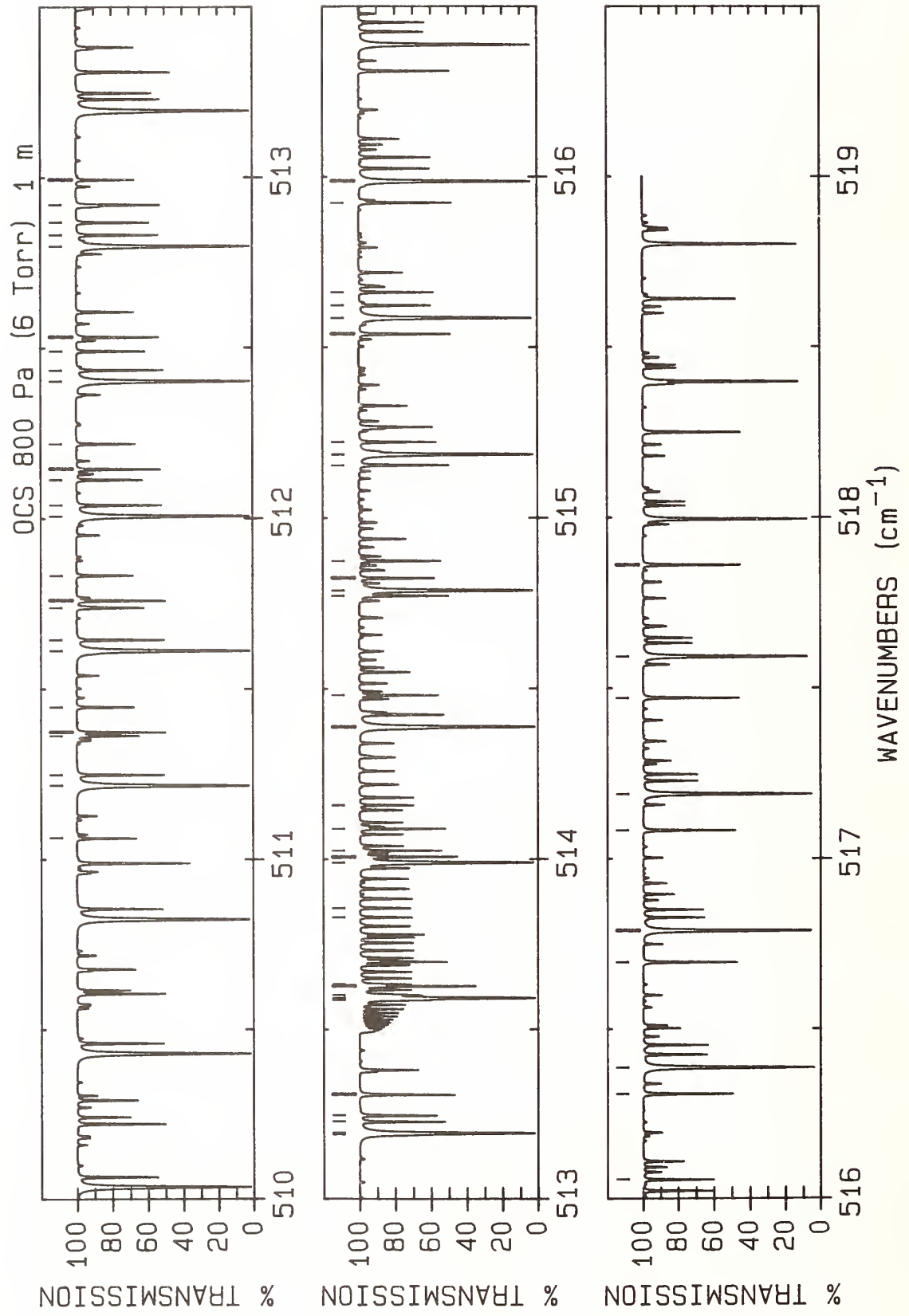

LINE #	WAVENUMBER(unc) (cm ⁻¹)	LOWER STATE (cm ⁻¹)	INTENSITY (cm/molecule)	ASSIGNMENT ROTATION BAND	LINE #	WAVENUMBER(unc) (cm ⁻¹)	LOWER STATE (cm ⁻¹)	INTENSITY (cm/molecule)	ASSIGNMENT ROTATION BAND
1	511.062 25(4)	100.13	0.833E-22	P(22)	36	513.633 51(16)	913.98	0.647E-22	Q(16)
2	511.217 62(15)*	111.96	0.190E-20	P(23)	37	513.829 47(16)	990.41	0.689E-22	Q(25)
3	511.248 93(28)	642.40	0.138E-21	P(24)	38	513.856 40(16)	1000.93	0.681E-22	Q(26)
4	511.363 09(15)*	837.16	0.841E-22	P(39)	39	513.990 62(15)*	55.17	0.178E-20	P(16)
5	511.373 88(28)	642.27	0.144E-21	P(24)	40	514.006 45(16)	1059.56	0.609E-22	Q(31)
6	511.447 62(5)	91.42	0.833E-22	P(21)	41	514.008 14(15)*	734.85	0.124E-21	P(32)
7	511.612 23(15)*	102.63	0.191E-20	P(22)	42	514.025 66(28)	582.63	0.129E-21	P(17)
8	511.644 08(28)	632.64	0.138E-21	P(23)	43	514.090 02(28)	582.57	0.132E-21	P(17)
9	511.738 22(15)*	821.33	0.896E-22	P(38)	44	514.159 27(5)	41.56	0.719E-22	P(14)
10	511.759 23(28)	632.52	0.144E-21	P(23)	45	514.388 80(15)*	48.68	0.172E-20	P(15)
11	511.833 49(5)	83.11	0.829E-22	P(20)	46	514.389 57(15)*	721.86	0.129E-21	P(31)
12	512.007 34(15)*	93.71	0.191E-20	P(21)	47	514.481 63(28)	575.66	0.127E-21	P(16)
13	512.039 75(28)	623.29	0.139E-21	P(22)	48	514.771 87(15)*	709.27	0.135E-21	P(30)
14	512.114 28(15)*	805.90	0.953E-22	P(37)	49	514.787 49(15)*	42.60	0.166E-20	P(14)
15	512.145 46(28)	623.18	0.144E-21	P(22)	50	514.823 55(28)	569.22	0.119E-21	P(15)
16	512.219 87(5)	75.19	0.821E-22	P(19)	51	514.874 14(28)	569.16	0.122E-21	P(15)
17	512.402 97(15)*	85.19	0.190E-20	P(20)	52	515.155 04(15)*	697.09	0.140E-21	P(29)
18	512.435 92(28)	614.35	0.138E-21	P(21)	53	515.186 69(15)*	36.92	0.158E-20	P(13)
19	512.491 25(15)*	790.88	0.101E-21	P(36)	54	515.223 25(28)	563.12	0.113E-21	P(14)
20	512.532 58(28)	614.25	0.143E-21	P(21)	55	515.539 07(15)*	685.31	0.145E-21	P(28)
21	512.799 12(15)*	77.08	0.189E-20	P(19)	56	515.586 40(15)*	31.64	0.150E-20	P(12)
22	512.832 59(28)	605.81	0.137E-21	P(20)	57	515.623 45(28)	557.42	0.107E-21	P(13)
23	512.869 13(15)*	776.26	0.107E-21	P(35)	58	515.661 89(28)	557.38	0.108E-21	P(13)
24	512.920 60(28)	605.72	0.141E-21	P(20)	59	515.923 95(15)*	673.94	0.149E-21	P(27)
25	512.994 12(5)	60.55	0.793E-22	P(17)	60	515.986 61(15)*	26.78	0.140E-20	P(11)
26	513.190 20(6)	76.83	0.289E-22	R(19)	61	516.057 12(28)	552.11	0.101E-21	P(12)
27	513.195 77(15)*	69.37	0.186E-20	P(18)	62	516.309 67(15)*	662.98	0.153E-21	P(26)
28	513.229 78(28)	597.68	0.135E-21	P(19)	63	516.387 33(15)*	22.31	0.130E-20	P(10)
29	513.247 91(15)*	762.05	0.112E-21	P(34)	64	516.696 23(15)*	652.42	0.157E-21	P(25)
30	513.309 50(28)	597.60	0.139E-21	P(19)	65	516.788 55(15)*	18.26	0.118E-20	P(9)
31	513.586 80(16)	895.77	0.578E-22	Q(13)	66	517.083 63(15)*	642.27	0.160E-21	P(24)
32	513.592 94(15)*	62.07	0.183E-20	P(17)	67	517.190 27(15)*	14.61	0.106E-20	P(8)
33	513.601 33(16)	901.44	0.604E-22	Q(14)	68	517.471 85(15)*	632.52	0.162E-21	P(23)
34	513.627 46(28)	589.95	0.132E-21	P(18)	69	517.592 50(15)*	11.36	0.927E-21	P(7)
35	513.627 58(15)*	748.25	0.118E-21	P(33)	70	517.860 90(15)*	623.18	0.164E-21	P(22)

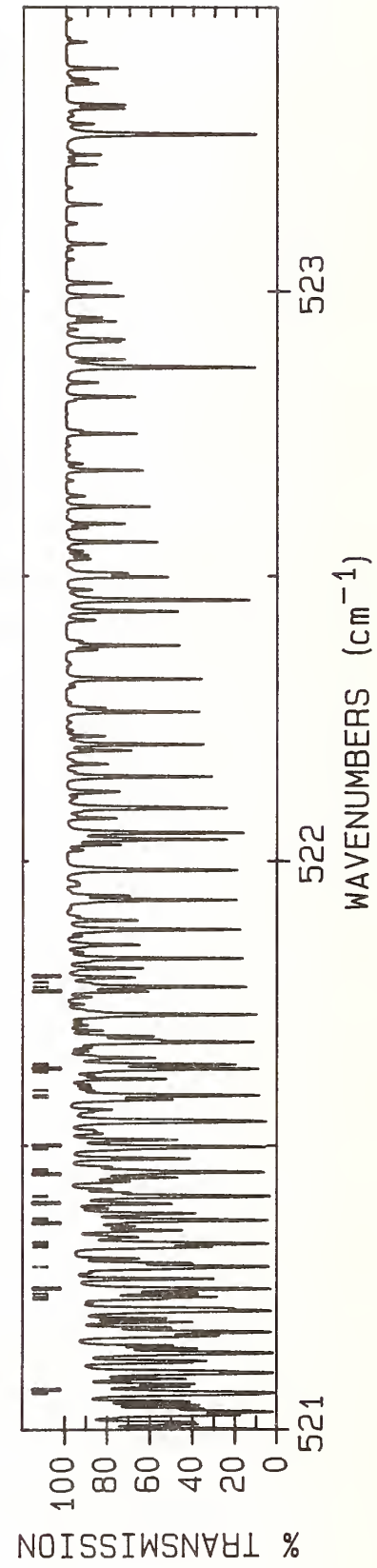
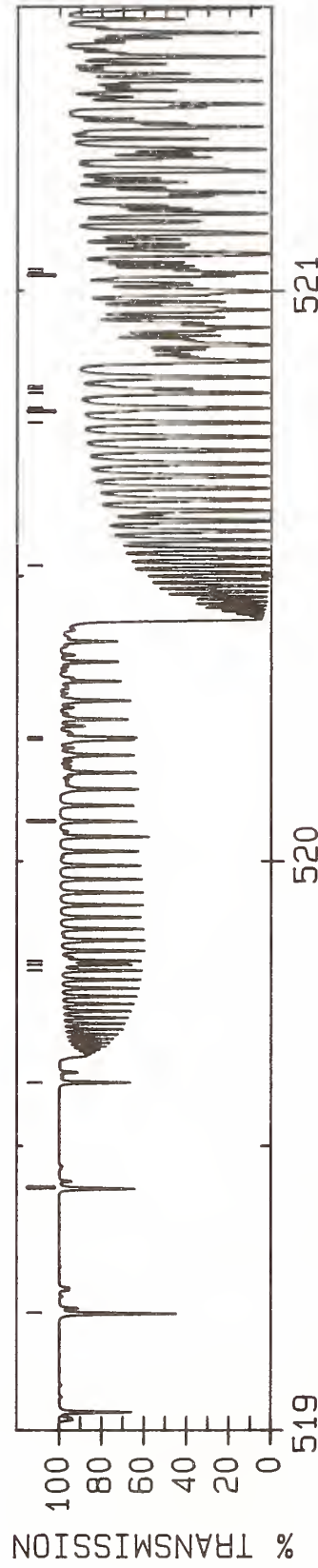
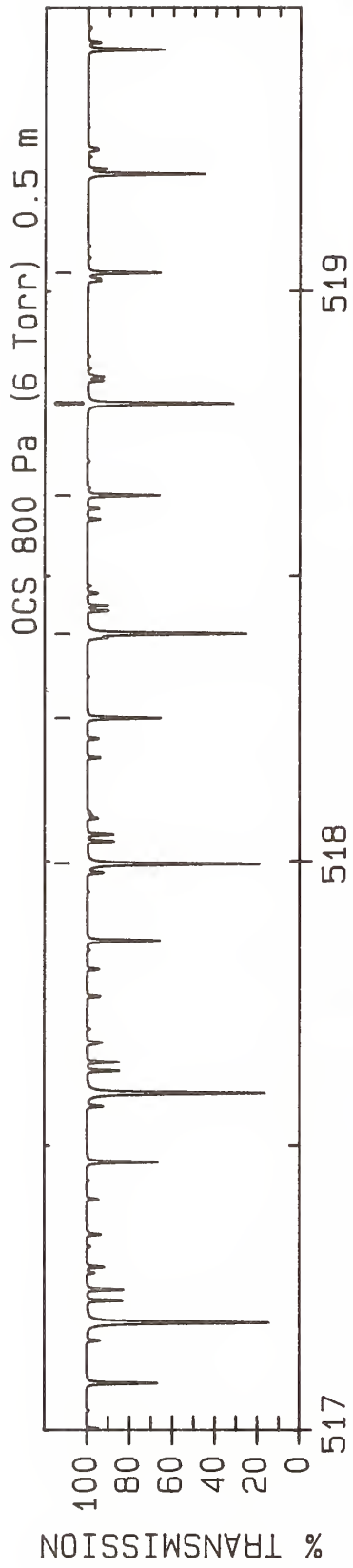

LINE #	WAVENUMBER(unc) (cm ⁻¹)	LOWER STATE (cm ⁻¹)	INTENSITY (cm/molecule)	ASSIGNMENT ROTATION BAND	LINE #	WAVENUMBER(unc) (cm ⁻¹)	LOWER STATE (cm ⁻¹)	INTENSITY (cm/molecule)	ASSIGNMENT ROTATION BAND
1	517.995 22(15)*	8.52	0.788E-21	P(6)	36	521.288 23(15)*	383.65	0.229E-20	Q(43)
2	518.250 77(15)*	614.25	0.165E-21	P(21)	37	521.322 85(28)	721.86	0.321E-21	Q(31)
3	518.398 45(15)*	6.09	0.641E-21	P(5)	38	521.328 38(15)*	401.49	0.215E-20	Q(44)
4	518.641 45(15)*	605.72	0.166E-21	P(20)	39	521.331 28(13)	747.86	0.238E-22	Q(61)
5	518.802 18(15)*	4.06	0.488E-21	P(4)	40	521.363 68(25)	1068.16	0.312E-22	Q(11)
6	518.803 38(16)	890.52	0.329E-22	R(12)	41	521.369 43(15)*	419.73	0.201E-20	Q(45)
7	519.032 94(15)*	597.60	0.166E-21	P(19)	42	521.371 85(25)	1073.05	0.333E-22	Q(12)
8	519.206 40(15)*	2.43	0.330E-21	P(3)	43	521.372 03(25)	1073.05	0.333E-22	Q(12)
9	519.425 23(15)*	589.88	0.165E-21	P(18)	44	521.398 33(26)	998.38	0.106E-21	Q(48)
10	519.427 03(16)	1109.30	0.226E-22	P(17)	45	521.398 62(15)*	557.38	0.148E-21	P(13)
11	519.611 12(15)*	1.22	0.167E-21	P(2)	46	521.400 84(25)	1090.14	0.385E-22	Q(15)
12	519.808 07(5)	67.68	0.195E-21	Q(18)	47	521.401 27(25)	1090.14	0.385E-22	Q(15)
13	519.818 33(15)*	582.57	0.163E-21	P(17)	48	521.411 38(15)*	438.37	0.188E-20	Q(46)
14	519.824 99(5)	75.19	0.198E-21	Q(19)	49	521.411 87(25)	1096.66	0.398E-22	Q(16)
15	520.069 66(4)	184.01	0.183E-21	Q(30)	50	521.450 14(24)	1118.64	0.425E-22	Q(19)
16	520.212 22(15)*	575.66	0.161E-21	P(16)	51	521.454 23(15)*	457.42	0.175E-20	Q(47)
17	520.216 25(5)	249.29	0.155E-21	Q(35)	52	521.458 79(26)	1059.31	0.819E-22	Q(51)
18	520.518 47(15)*	42.60	0.400E-20	Q(14)	53	521.494 26(24)	1144.28	0.433E-22	Q(22)
19	520.768 82(15)*	153.34	0.443E-20	Q(27)	54	521.497 98(15)*	476.88	0.162E-20	Q(48)
20	520.787 75(7)	504.37	0.638E-22	Q(50)	55	521.500 19(26)	1101.95	0.678E-22	Q(53)
21	520.794 48(15)*	164.69	0.435E-20	Q(28)	56	521.585 25(25)	1192.10	0.451E-22	Q(57)
22	520.821 04(15)*	176.45	0.425E-20	Q(29)	57	521.588 16(15)*	517.00	0.139E-20	Q(50)
23	520.828 26(15)*	0.00	0.341E-21	R(0)	58	521.596 85(24)	1206.55	0.405E-22	Q(28)
24	520.832 84(7)	524.53	0.590E-22	Q(51)	59	521.628 73(25)	1239.61	0.363E-22	Q(59)
25	521.027 13(28)	589.88	0.356E-21	Q(18)	60	521.634 60(15)*	537.67	0.129E-20	Q(51)
26	521.032 43(15)*	270.13	0.334E-20	Q(36)	61	521.636 97(24)	1230.57	0.385E-22	Q(30)
27	521.038 35(28)	663.13	0.340E-21	Q(26)	62	521.641 95(5)	3.96	0.442E-22	R(4)
28	521.063 79(28)	685.49	0.325E-21	Q(28)	63	521.642 16(15)*	1.22	0.686E-21	R(2)
29	521.066 26(15)*	285.13	0.319E-20	Q(37)	64	521.643 67(24)	1230.56	0.385E-22	Q(30)
30	521.071 27(9)	631.27	0.386E-22	Q(56)	65	521.771 09(27)	922.39	0.171E-21	Q(44)
31	521.231 33(27)	837.49	0.203E-21	Q(39)	66	521.772 83(24)	1312.36	0.308E-22	Q(36)
32	521.234 96(15)*	0.41	0.514E-21	R(1)	67	521.779 26(15)*	602.10	0.994E-21	Q(54)
33	521.241 03(28)	685.31	0.346E-21	Q(28)	68	521.786 73(24)	1312.34	0.308E-22	Q(36)
34	521.248 69(27)	853.74	0.191E-21	Q(40)	69	521.795 65(15)*	552.11	0.142E-21	P(12)
35	521.248 98(15)*	366.22	0.244E-20	Q(42)	70	521.797 70(24)	1327.41	0.293E-22	Q(37)

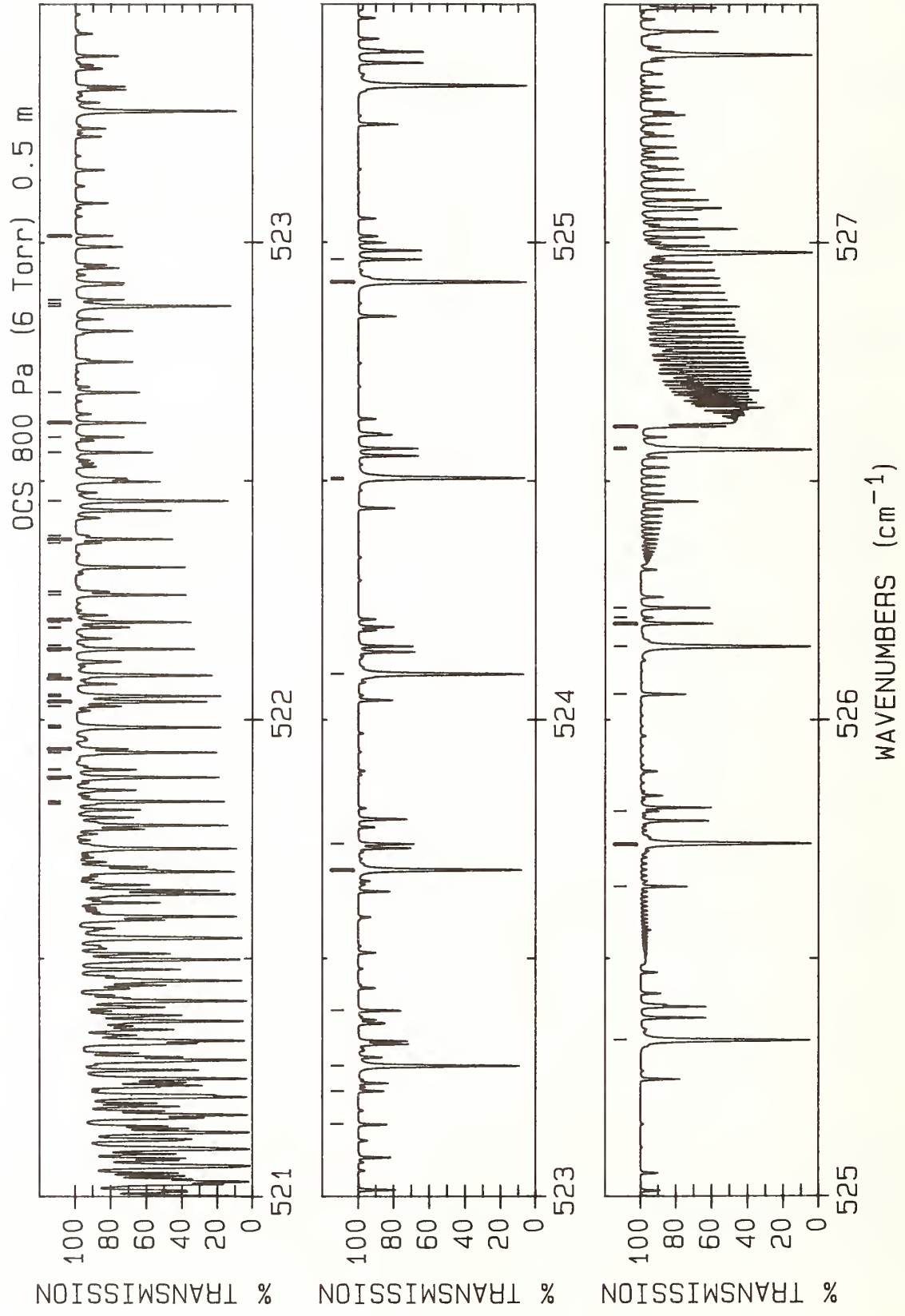

LINE #	WAVENUMBER(unc) (cm ⁻¹)	LOWER STATE (cm ⁻¹)	INTENSITY (cm/molecule)	ASSIGNMENT ROTATION BAND	LINE #	WAVENUMBER(unc) (cm ⁻¹)	LOWER STATE (cm ⁻¹)	INTENSITY (cm/molecule)	ASSIGNMENT ROTATION BAND
1	521.823 19(24)	1342.87	0.279E-22	Q(38) F	36	522.385 55(31)	348.07	0.177E-22	R(41) T
2	521.829 27(15)*	624.39	0.909E-21	Q(55) A	37	522.458 01(15)*	4.06	0.103E-20	R(4) A
3	521.829 42(24)	1473.41	0.119E-22	Q(68) C	38	522.559 93(15)*	950.85	0.230E-21	Q(68) A
4	521.876 04(24)	1375.01	0.250E-22	Q(40) F	39	522.592 05(15)*	542.76	0.128E-21	P(10) H
5	521.880 16(15)*	647.08	0.828E-21	Q(56) A	40	522.622 30(15)*	978.78	0.204E-21	Q(69) A
6	521.896 03(27)	978.40	0.139E-21	Q(47) B	41	522.685 54(15)*	1007.13	0.180E-21	Q(70) A
7	521.897 27(24)	1374.99	0.251E-22	Q(40) E	42	522.866 67(15)*	6.09	0.119E-20	R(5) A
8	521.931 34(24)	1408.78	0.222E-22	Q(42) F	43	522.872 46(24)	1417.69	0.231E-22	Q(66) B
9	521.931 95(15)*	670.17	0.754E-21	Q(57) A	44	522.880 49(15)*	1094.57	0.123E-21	Q(73) A
10	521.939 46(26)	997.88	0.129E-21	Q(48) B	45	523.014 80(15)*	1154.87	0.941E-22	Q(75) A
11	521.983 78(26)	1017.76	0.120E-21	Q(49) B	46	523.152 58(15)*	1216.79	0.715E-22	Q(77) A
12	521.984 62(15)*	693.67	0.684E-21	Q(58) A	47	523.222 76(15)*	1248.35	0.621E-22	Q(78) A
13	521.988 33(23)	1426.24	0.209E-22	Q(43) E	48	523.275 83(15)*	8.52	0.135E-20	R(6) A
14	522.028 99(26)	1038.05	0.111E-21	Q(50) B	49	523.391 54(15)*	535.04	0.110E-21	P(8) H
15	522.038 18(15)*	717.57	0.620E-21	Q(59) A	50	523.685 46(15)*	11.36	0.151E-20	R(7) A
16	522.040 65(5)	5.94	0.514E-22	R(5) P	51	523.740 17(28)	528.95	0.139E-21	R(6) B
17	522.049 15(23)	1481.18	0.170E-22	Q(46) F	52	524.095 58(15)*	14.61	0.166E-20	R(8) A
18	522.049 84(15)*	2.43	0.857E-21	R(3) A	53	524.502 60(46)	436.96	0.131E-22	R(46) T
19	522.052 98(23)	1462.44	0.183E-22	Q(45) E	54	524.506 19(15)*	18.26	0.180E-20	R(9) A
20	522.086 51(23)	1481.14	0.170E-22	Q(46) E	55	524.917 28(15)*	22.31	0.194E-20	R(10) A
21	522.092 62(15)*	741.87	0.560E-21	Q(60) A	56	524.964 22(28)	538.72	0.173E-21	R(9) C
22	522.094 08(28)	521.64	0.913E-22	R(2) C	57	525.328 85(15)*	26.78	0.207E-20	R(11) A
23	522.095 35(28)	521.64	0.914E-22	R(2) B	58	525.650 30(24)	704.08	0.158E-22	Q(30) S
24	522.143 66(23)	1539.75	0.135E-22	Q(49) F	59	525.650 45(5)	41.56	0.104E-21	R(14) P
25	522.147 95(15)*	766.58	0.505E-21	Q(61) A	60	525.738 93(24)	798.44	0.127E-22	Q(37) S
26	522.155 98(23)	1519.78	0.147E-22	Q(48) E	61	525.740 90(15)*	31.64	0.218E-20	R(12) A
27	522.191 94(23)	1539.70	0.136E-22	Q(49) E	62	525.808 33(15)*	521.64	0.405E-22	P(2) H
28	522.193 46(15)*	547.23	0.135E-21	P(11) H	63	526.053 90(5)	47.49	0.107E-21	R(15) P
29	522.204 16(15)*	791.70	0.454E-21	Q(62) A	64	526.153 43(15)*	36.92	0.229E-20	R(13) A
30	522.209 51(23)	1580.82	0.114E-22	Q(51) F	65	526.201 44(28)	552.14	0.201E-21	R(12) C
31	522.261 26(15)*	817.21	0.408E-21	Q(63) A	66	526.213 79(15)*	520.83	0.273E-22	P(1) H
32	522.261 69(16)	1069.42	0.162E-22	P(10) G	67	526.234 29(28)	552.11	0.204E-21	R(12) B
33	522.268 35(26)	1145.56	0.723E-22	Q(55) B	68	526.566 43(15)*	42.60	0.239E-20	R(14) A
34	522.370 28(25)	1191.40	0.600E-22	Q(57) B	69	526.570 38(16)	1149.99	0.592E-22	Q(22) G
35	522.378 09(15)*	869.46	0.326E-21	Q(65) A	70	526.614 80(28)	557.42	0.209E-21	R(13) C

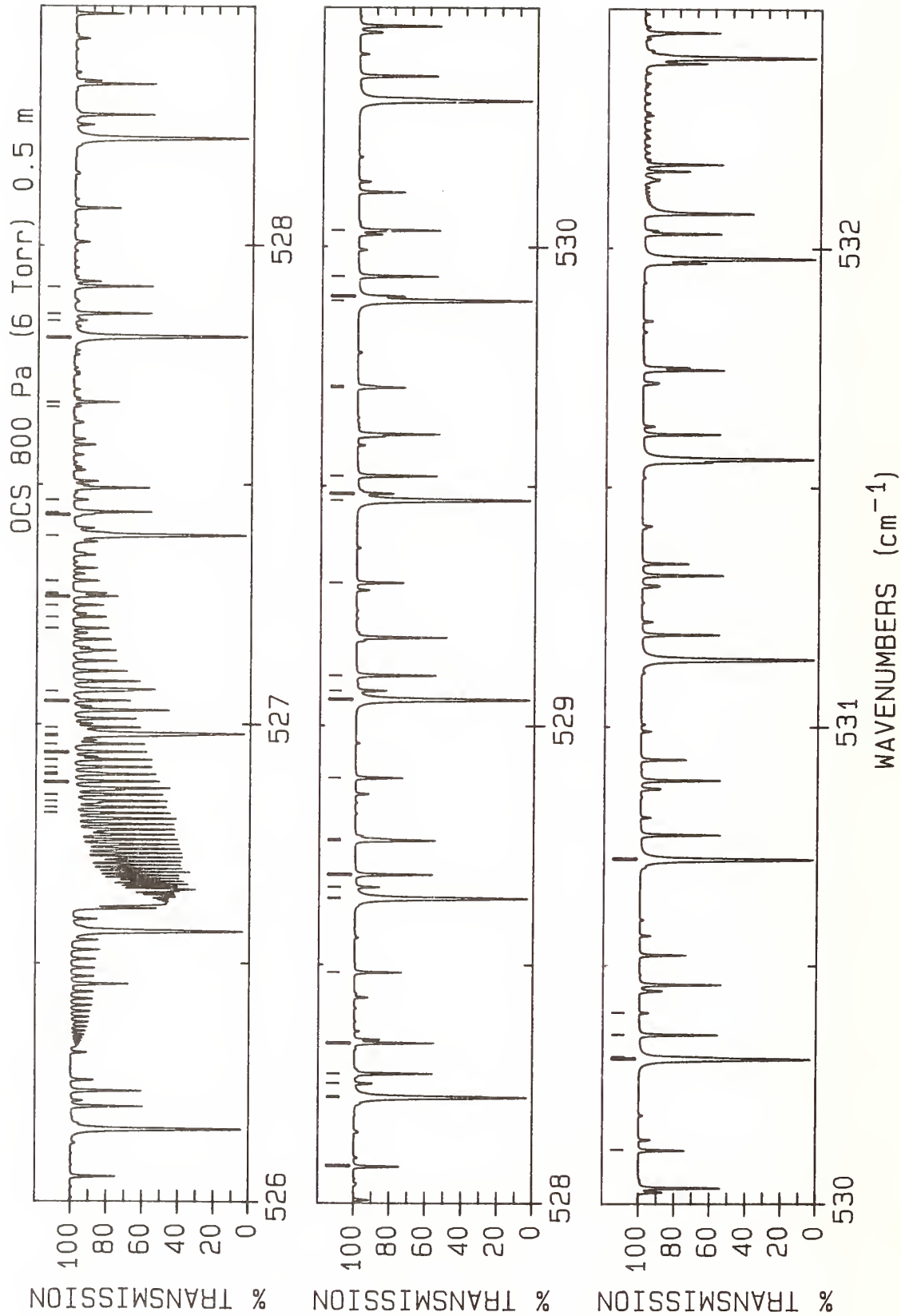

LINE #	WAVENUMBER(unc) (cm ⁻¹)	LOWER STATE (cm ⁻¹)	INTENSITY (cm/molecule)	ASSIGNMENT ROTATION BAND	LINE #	WAVENUMBER(unc) (cm ⁻¹)	LOWER STATE (cm ⁻¹)	INTENSITY (cm/molecule)	ASSIGNMENT ROTATION BAND
1	526.814 14(15)*	748.49	0.329E-21	Q(33) H	36	528.223 22(15)*	69.37	0.268E-20	R(18) A
2	526.826 54(15)*	762.31	0.318E-21	Q(34) H	37	528.225 54(5)	594.94	0.107E-22	R(19) Q
3	526.839 37(15)*	776.53	0.307E-21	Q(35) H	38	528.252 35(15)*	522.86	0.415E-22	R(3) H
4	526.852 65(15)*	791.16	0.296E-21	Q(36) H	39	528.272 92(28)	582.63	0.233E-21	R(17) C
5	526.880 57(15)*	821.64	0.272E-21	Q(38) H	40	528.336 95(28)	582.57	0.238E-21	R(17) B
6	526.895 24(15)*	837.49	0.259E-21	Q(39) H	41	528.484 43(4)	91.42	0.121E-21	R(21) P
7	526.898 76(17)	1289.13	0.473E-22	Q(34) G	42	528.638 60(15)*	77.08	0.272E-20	R(19) A
8	526.910 37(15)*	853.74	0.247E-21	Q(40) H	43	528.639 90(5)	602.87	0.109E-22	R(20) Q
9	526.925 99(15)*	870.40	0.235E-21	Q(41) H	44	528.662 32(15)*	524.48	0.552E-22	R(4) H
10	526.942 10(15)*	887.47	0.223E-21	Q(42) H	45	528.688 62(28)	589.95	0.236E-21	R(18) C
11	526.958 71(15)*	904.94	0.210E-21	Q(43) H	46	528.760 08(28)	589.88	0.242E-21	R(18) B
12	526.975 83(15)*	922.82	0.198E-21	Q(44) H	47	528.763 09(24)	1103.58	0.309E-22	R(17) F
13	526.979 92(15)*	48.68	0.248E-20	R(15) A	48	528.891 15(4)	100.13	0.122E-21	R(22) P
14	526.993 46(15)*	941.10	0.187E-21	Q(45) H	49	529.054 45(15)*	85.19	0.275E-20	R(20) A
15	527.049 53(15)*	998.38	0.153E-21	Q(48) H	50	529.055 08(5)	611.19	0.109E-22	R(21) Q
16	527.069 30(15)*	1018.28	0.143E-21	Q(49) H	51	529.073 03(15)*	526.51	0.686E-22	R(5) H
17	527.200 06(15)*	1146.22	0.895E-22	Q(55) H	52	529.104 78(28)	597.68	0.239E-21	R(19) C
18	527.223 96(15)*	1168.96	0.821E-22	Q(56) H	53	529.298 32(4)	109.23	0.122E-21	R(23) P
19	527.248 48(15)*	1192.10	0.752E-22	Q(57) H	54	529.470 77(15)*	93.71	0.278E-20	R(21) A
20	527.267 08(5)	67.68	0.116E-21	R(18) P	55	529.484 50(15)*	528.95	0.817E-22	R(6) H
21	527.271 85(17)	1449.79	0.287E-22	Q(44) G	56	529.521 40(28)	605.81	0.241E-21	R(20) C
22	527.273 64(15)*	1215.65	0.687E-22	Q(58) H	57	529.705 94(4)	118.72	0.122E-21	R(24) P
23	527.299 45(15)*	1239.61	0.626E-22	Q(59) H	58	529.709 25(15)	1158.61	0.291E-22	R(38) D
24	527.393 88(15)*	55.17	0.256E-20	R(16) A	59	529.887 55(15)*	102.63	0.279E-20	R(22) A
25	527.438 59(15)*	1365.45	0.381E-22	Q(64) H	60	529.896 72(15)*	531.80	0.944E-22	R(7) H
26	527.442 92(28)	569.22	0.223E-21	R(15) C	61	529.938 49(28)	614.35	0.242E-21	R(21) C
27	527.468 51(15)*	1391.83	0.343E-22	Q(65) H	62	530.034 55(28)	614.25	0.250E-21	R(21) B
28	527.663 56(15)*	1558.62	0.173E-22	Q(71) H	63	530.114 03(4)	128.62	0.121E-21	R(25) P
29	527.672 40(5)	75.19	0.118E-21	R(19) P	64	530.304 80(15)*	111.96	0.279E-20	R(23) A
30	527.808 31(15)*	62.07	0.262E-20	R(17) A	65	530.305 46(5)	638.52	0.110E-22	R(24) Q
31	527.809 15(15)*	1677.89	0.106E-22	Q(75) H	66	530.309 69(15)*	535.04	0.107E-21	R(8) H
32	527.843 13(15)*	521.64	0.277E-22	R(2) H	67	530.356 04(28)	623.29	0.242E-21	R(22) C
33	527.857 69(28)	575.72	0.228E-21	R(16) C	68	530.402 12(16)	1065.36	0.225E-22	R(9) G
34	527.914 69(28)	575.66	0.233E-21	R(16) B	69	530.722 52(15)*	121.70	0.278E-20	R(24) A
35	528.078 19(4)	83.11	0.120E-21	R(20) P	70	530.723 41(15)*	538.70	0.118E-21	R(9) H

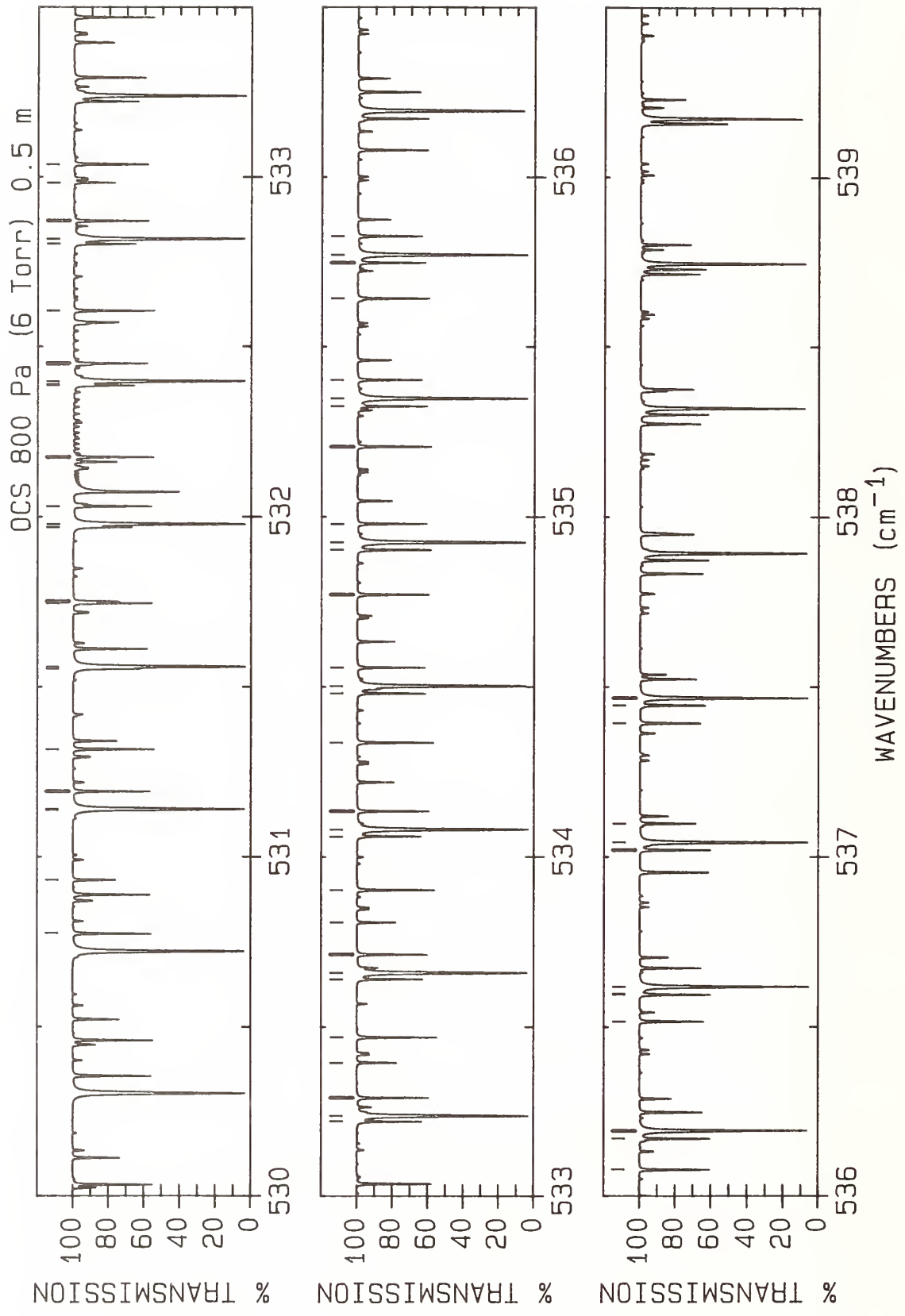

LINE #	WAVENUMBER(unc) (cm ⁻¹)	LOWER STATE (cm ⁻¹)	INTENSITY (cm/molecule)	ASSIGNMENT ROTATION BAND	LINE #	WAVENUMBER(unc) (cm ⁻¹)	LOWER STATE (cm ⁻¹)	INTENSITY (cm/molecule)	ASSIGNMENT ROTATION BAND
1	530.774 05(28)	632.64	0.241E-21	R(23) C	36	533.807 15(5)	235.44	0.100E-21	R(34) P
2	530.931 57(4)	149.59	0.119E-21	R(27) P	37	533.902 52(28)	709.27	0.231E-21	R(30) B
3	531.137 89(15)*	542.76	0.129E-21	R(10) H	38	534.060 39(15)*	582.57	0.185E-21	R(17) H
4	531.140 69(15)*	131.84	0.276E-20	R(25) A	39	534.080 79(15)*	214.17	0.242E-20	R(32) A
5	531.192 51(28)	642.40	0.240E-21	R(24) C	40	534.134 45(28)	722.07	0.210E-21	R(31) C
6	531.316 56(28)	642.27	0.251E-21	R(24) B	41	534.336 27(28)	721.86	0.226E-21	R(31) B
7	531.553 12(15)*	547.23	0.140E-21	R(11) H	42	534.480 93(15)*	589.88	0.189E-21	R(18) H
8	531.559 33(15)*	142.38	0.274E-20	R(26) A	43	534.502 62(15)*	227.55	0.234E-20	R(33) A
9	531.745 54(28)	652.42	0.249E-21	R(25) B	44	534.556 52(28)	735.07	0.204E-21	R(32) C
10	531.750 92(4)	172.14	0.115E-21	R(29) P	45	534.770 80(28)	734.85	0.220E-21	R(32) B
11	531.969 10(15)*	552.11	0.149E-21	R(12) H	46	534.902 24(15)*	597.60	0.193E-21	R(19) H
12	531.978 43(15)*	153.34	0.270E-20	R(27) A	47	534.903 21(16)	1132.50	0.340E-22	R(20) G
13	532.030 81(28)	663.13	0.234E-21	R(26) C	48	534.924 90(15)*	241.34	0.226E-20	R(34) A
14	532.171 99(29)	1090.14	0.132E-22	Q(15) I	49	534.979 04(28)	748.49	0.197E-21	R(33) C
15	532.175 34(28)	662.98	0.247E-21	R(26) B	50	535.206 09(28)	748.25	0.214E-21	R(33) B
16	532.385 84(15)*	557.38	0.158E-21	R(13) H	51	535.324 32(15)*	605.72	0.195E-21	R(20) H
17	532.388 81(29)	1195.15	0.134E-22	Q(27) I	52	535.347 63(15)*	255.53	0.218E-20	R(35) A
18	532.397 99(15)*	164.69	0.266E-20	R(28) A	53	535.401 99(28)	762.31	0.191E-21	R(34) C
19	532.446 22(16)	1089.77	0.297E-22	R(14) G	54	535.642 13(28)	762.05	0.208E-21	R(34) B
20	532.450 64(28)	674.10	0.231E-21	R(27) C	55	535.747 18(15)*	614.25	0.197E-21	R(21) H
21	532.605 94(28)	673.94	0.244E-21	R(27) B	56	535.770 80(15)*	270.13	0.210E-20	R(36) A
22	532.606 22(29)	1297.69	0.100E-22	Q(35) I	57	535.825 39(28)	776.53	0.183E-21	R(35) C
23	532.803 34(15)*	563.07	0.166E-21	R(14) H	58	536.078 91(28)	776.26	0.201E-21	R(35) B
24	532.818 01(15)*	176.45	0.261E-20	R(29) A	59	536.170 81(15)*	623.18	0.198E-21	R(22) H
25	532.870 91(28)	685.49	0.227E-21	R(28) C	60	536.194 42(15)*	285.13	0.201E-20	R(37) A
26	532.983 32(4)	208.93	0.107E-21	R(32) P	61	536.516 44(27)	790.88	0.194E-21	R(36) B
27	533.037 34(28)	685.31	0.240E-21	R(28) B	62	536.595 22(15)*	632.52	0.198E-21	R(23) H
28	533.221 59(15)*	569.16	0.173E-21	R(15) H	63	536.598 33(16)	1459.26	0.102E-22	R(54) D
29	533.238 48(15)*	188.62	0.255E-20	R(30) A	64	536.618 48(15)*	300.54	0.192E-20	R(38) A
30	533.291 65(28)	697.27	0.222E-21	R(29) C	65	537.020 41(15)*	642.27	0.197E-21	R(24) H
31	533.395 01(4)	221.99	0.104E-21	R(33) P	66	537.042 99(15)*	316.35	0.183E-20	R(39) A
32	533.469 54(28)	697.09	0.236E-21	R(29) B	67	537.098 22(27)	821.64	0.161E-21	R(38) C
33	533.640 61(15)*	575.66	0.179E-21	R(16) H	68	537.393 65(27)	821.33	0.179E-21	R(38) B
34	533.659 41(15)*	201.19	0.248E-20	R(31) A	69	537.446 39(15)*	652.42	0.196E-21	R(25) H
35	533.712 82(28)	709.47	0.216E-21	R(30) C	70	537.467 93(15)*	332.57	0.174E-20	R(40) A

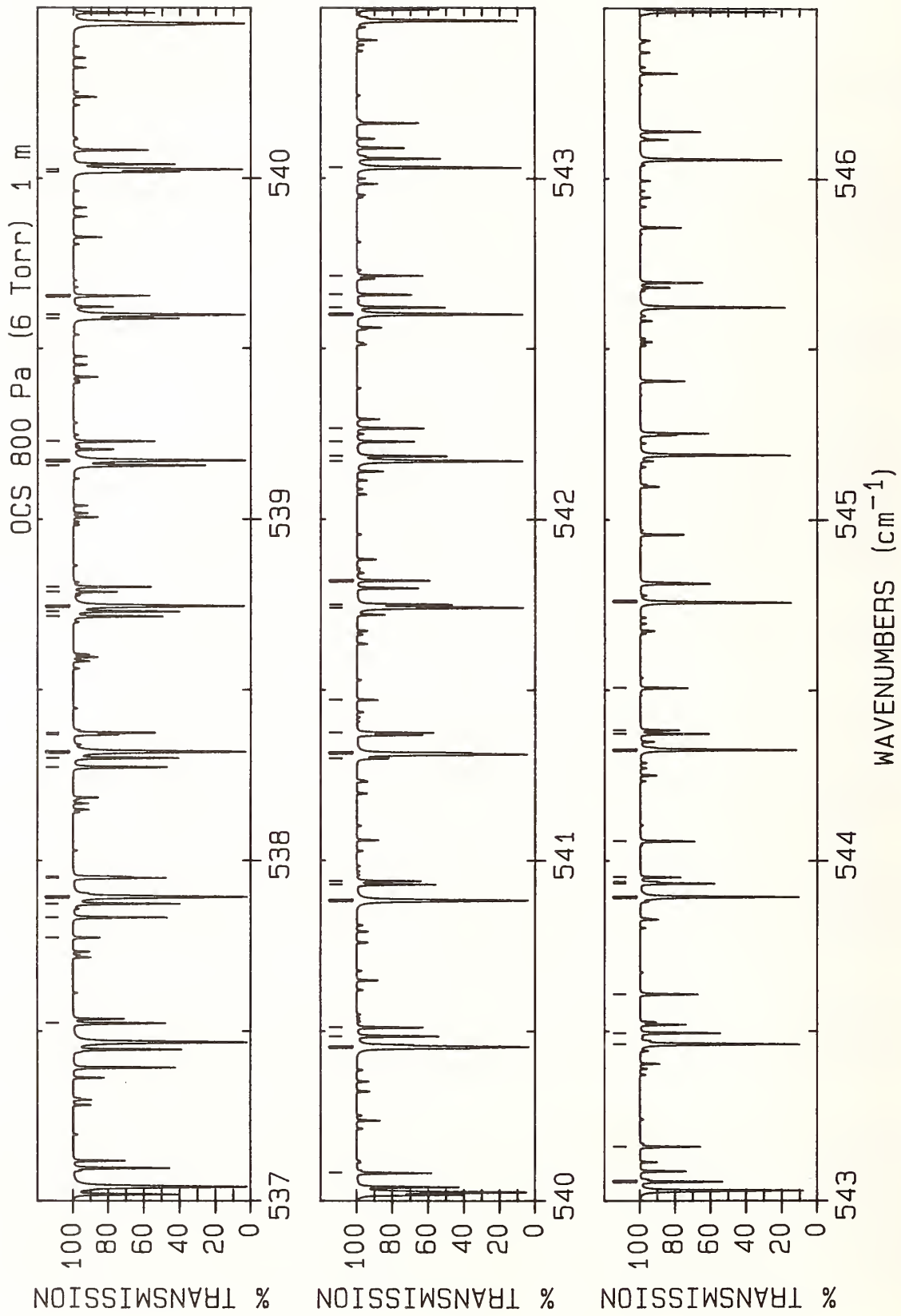

LINE #	WAVENUMBER(unc) (cm ⁻¹)	LOWER STATE (cm ⁻¹)	INTENSITY (cm/molecule)	ASSIGNMENT ROTATION BAND	LINE #	WAVENUMBER(unc) (cm ⁻¹)	LOWER STATE (cm ⁻¹)	INTENSITY (cm/molecule)	ASSIGNMENT ROTATION BAND
1	537.523 36(27)	837.49	0.153E-21	R(39) C	36	540.930 12(26)	959.33	0.118E-21	R(46) B
2	537.774 46(16)	1200.85	0.329E-22	R(27) G	37	540.939 95(26)	978.88	0.949E-22	R(47) C
3	537.833 33(27)	837.16	0.171E-21	R(39) B	38	541.299 84(8)	545.09	0.363E-22	R(52) P
4	537.873 15(15)*	662.98	0.193E-21	R(26) H	39	541.311 95(15)*	496.74	0.994E-21	R(49) A
5	537.893 32(15)*	349.19	0.165E-20	R(41) A	40	541.316 22(15)*	762.05	0.156E-21	R(34) H
6	537.948 94(27)	853.74	0.146E-21	R(40) C	41	541.375 11(26)	978.40	0.111E-21	R(47) B
7	537.952 63(5)	391.68	0.629E-22	R(44) P	42	541.471 57(17)	1318.01	0.249E-22	R(36) G
8	538.273 71(27)	853.39	0.164E-21	R(40) B	43	541.741 20(15)*	517.00	0.923E-21	R(50) A
9	538.300 71(15)*	673.94	0.190E-21	R(27) H	44	541.750 29(15)*	776.26	0.150E-21	R(35) H
10	538.319 13(15)*	366.22	0.157E-20	R(42) A	45	541.820 72(26)	997.88	0.104E-21	R(48) B
11	538.369 56(6)	409.47	0.592E-22	R(45) P	46	542.170 87(15)*	537.67	0.855E-21	R(51) A
12	538.374 95(27)	870.40	0.138E-21	R(41) C	47	542.185 20(15)*	790.88	0.143E-21	R(36) H
13	538.714 78(27)	870.04	0.156E-21	R(41) B	48	542.228 13(26)	1038.59	0.762E-22	R(50) C
14	538.729 07(15)*	685.31	0.187E-21	R(28) H	49	542.266 94(26)	1017.76	0.973E-22	R(49) B
15	538.745 39(15)*	383.65	0.148E-20	R(43) A	50	542.600 96(15)*	558.74	0.790E-21	R(52) A
16	538.786 90(6)	427.66	0.556E-22	R(46) P	51	542.620 96(15)*	805.90	0.137E-21	R(37) H
17	538.801 38(27)	887.47	0.130E-21	R(42) C	52	542.658 35(26)	1059.31	0.705E-22	R(51) C
18	539.156 53(27)	887.08	0.148E-21	R(42) B	53	542.713 75(26)	1038.05	0.908E-22	R(50) B
19	539.158 23(15)*	697.09	0.183E-21	R(29) H	54	543.031 47(15)*	580.22	0.728E-21	R(53) A
20	539.172 08(15)*	401.49	0.139E-20	R(44) A	55	543.057 56(15)*	821.33	0.130E-21	R(38) H
21	539.228 25(27)	904.94	0.123E-21	R(43) C	56	543.161 14(26)	1058.74	0.846E-22	R(51) B
22	539.588 20(15)*	709.27	0.178E-21	R(30) H	57	543.462 39(15)*	602.10	0.669E-21	R(54) A
23	539.598 94(27)	904.54	0.141E-21	R(43) B	58	543.495 02(15)*	837.16	0.123E-21	R(39) H
24	539.599 20(15)*	419.73	0.131E-20	R(45) A	59	543.609 10(26)	1079.84	0.786E-22	R(52) B
25	539.655 54(27)	922.82	0.116E-21	R(44) C	60	543.893 73(15)*	624.39	0.614E-21	R(55) A
26	540.018 97(15)*	721.86	0.173E-21	R(31) H	61	543.933 34(15)*	853.39	0.116E-21	R(40) H
27	540.026 74(15)*	438.37	0.123E-20	R(46) A	62	543.938 24(17)	1414.41	0.183E-22	R(42) G
28	540.083 26(27)	941.10	0.109E-21	R(45) C	63	543.951 47(26)	1123.88	0.551E-22	R(54) C
29	540.450 57(15)*	734.85	0.168E-21	R(32) H	64	544.057 62(26)	1101.34	0.728E-22	R(53) B
30	540.454 72(15)*	457.42	0.115E-20	R(47) A	65	544.325 47(15)*	647.08	0.562E-21	R(56) A
31	540.485 75(27)	940.66	0.125E-21	R(45) B	66	544.372 53(15)*	870.04	0.110E-21	R(41) H
32	540.511 39(27)	959.78	0.102E-21	R(46) C	67	544.383 33(26)	1146.22	0.505E-22	R(55) C
33	540.879 97(7)	524.53	0.392E-22	R(51) P	68	544.506 69(26)	1123.25	0.674E-22	R(54) B
34	540.882 98(15)*	748.25	0.162E-21	R(33) H	69	544.757 63(15)*	670.17	0.513E-21	R(57) A
35	540.883 12(15)*	476.88	0.107E-20	R(48) A	70	544.760 57(17)	1449.79	0.161E-22	R(44) G

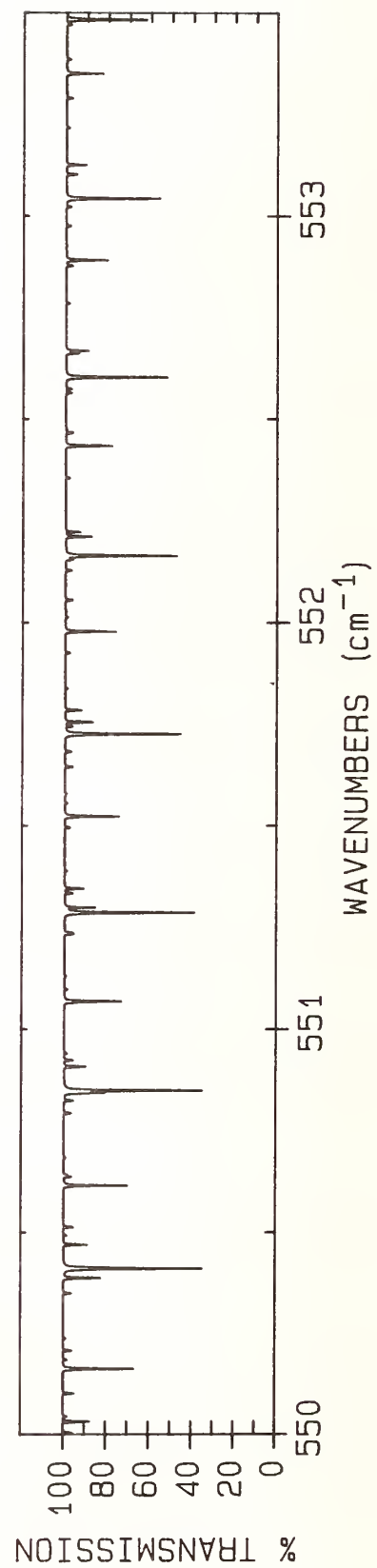
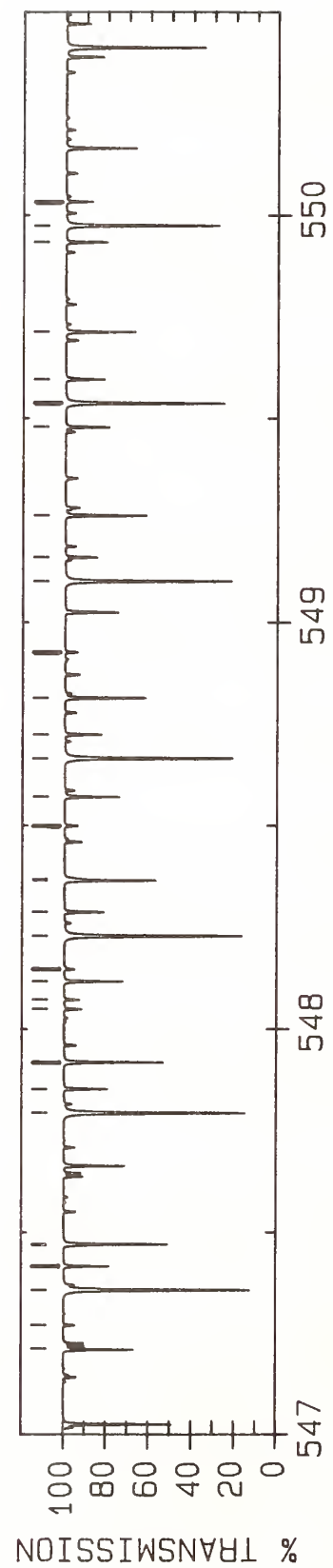
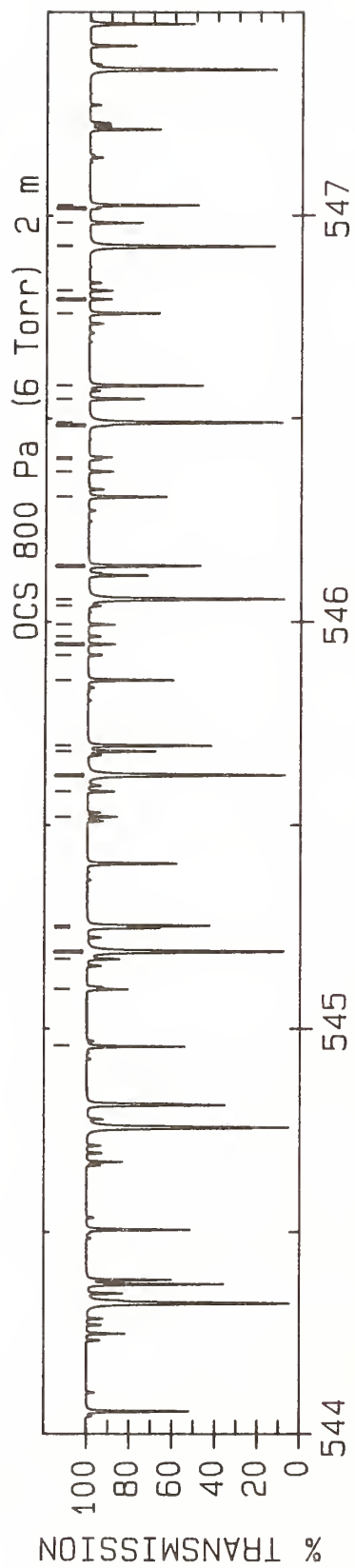

LINE #	WAVENUMBER(unc) (cm ⁻¹)	LOWER STATE (cm ⁻¹)	INTENSITY (cm/molecule)	ASSIGNMENT ROTATION BAND	LINE #	WAVENUMBER(unc) (cm ⁻¹)	LOWER STATE (cm ⁻¹)	INTENSITY (cm/molecule)	ASSIGNMENT ROTATION BAND
1	544.956 30(26)	1145.56	0.622E-22	R(55) B	36	547.026 31(15)*	978.40	0.728E-22	R(47) H
2	545.097 01(13)	747.86	0.165E-22	R(61) P	37	547.211 90(25)	1263.19	0.403E-22	R(60) B
3	545.097 76(29)	1230.57	0.681E-23	R(30) J	38	547.272 05(29)	1297.71	0.581E-23	R(35) J
4	545.171 74(17)	1468.09	0.151E-22	R(45) G	39	547.359 06(15)*	817.21	0.284E-21	R(63) A
5	545.190 19(15)*	693.67	0.468E-21	R(58) A	40	547.417 51(25)	1313.90	0.258E-22	R(62) C
6	545.248 25(25)	1192.10	0.421E-22	R(57) C	41	547.468 87(24)	1785.62	0.418E-23	R(60) E
7	545.253 54(15)*	904.54	0.968E-22	R(43) H	42	547.471 78(15)*	997.88	0.673E-22	R(48) H
8	545.520 93(14)	772.36	0.149E-22	R(62) P	43	547.794 03(15)*	843.13	0.256E-21	R(64) A
9	545.582 89(17)	1486.80	0.141E-22	R(46) G	44	547.852 54(25)	1339.47	0.232E-22	R(63) C
10	545.623 16(15)*	717.57	0.426E-21	R(59) A	45	547.918 18(15)*	1017.76	0.621E-22	R(49) H
11	545.681 31(25)	1215.65	0.384E-22	R(58) C	46	547.919 97(24)	1810.40	0.379E-23	R(61) E
12	545.695 38(15)*	922.39	0.905E-22	R(44) H	47	548.049 32(17)	1607.56	0.883E-23	R(52) G
13	545.857 06(25)	1191.40	0.526E-22	R(57) B	48	548.072 66(19)	927.63	0.788E-23	R(68) P
14	545.918 48(29)	1269.62	0.739E-23	R(33) I	49	548.117 44(25)	1313.07	0.333E-22	R(62) B
15	545.945 24(14)	797.25	0.135E-22	R(63) P	50	548.147 57(29)	1327.41	0.533E-23	R(37) J
16	545.965 00(29)	1256.20	0.645E-23	R(32) J	51	548.229 39(15)*	869.46	0.229E-21	R(65) A
17	545.994 03(17)	1505.91	0.131E-22	R(47) G	52	548.287 95(24)	1365.45	0.209E-22	R(64) C
18	546.039 99(23)	1713.77	0.549E-23	R(57) F	53	548.365 51(15)*	1038.05	0.571E-22	R(50) H
19	546.056 54(15)*	741.87	0.386E-21	R(60) A	54	548.368 73(29)	1358.72	0.608E-23	R(39) I
20	546.138 11(15)*	940.66	0.844E-22	R(45) H	55	548.499 30(20)	954.88	0.703E-23	R(69) P
21	546.308 19(25)	1214.93	0.482E-22	R(58) B	56	548.570 87(24)	1338.62	0.302E-22	R(63) B
22	546.369 95(15)	822.54	0.122E-22	R(64) P	57	548.665 14(15)*	896.18	0.205E-21	R(66) A
23	546.399 86(29)	1269.63	0.625E-23	R(33) J	58	548.723 76(24)	1391.83	0.187E-22	R(65) C
24	546.405 15(17)	1525.43	0.122E-22	R(48) G	59	548.813 79(15)*	1058.74	0.524E-22	R(51) H
25	546.483 27(23)	1737.35	0.501E-23	R(58) F	60	548.926 32(21)	982.53	0.626E-23	R(70) P
26	546.490 31(15)*	766.58	0.349E-21	R(61) A	61	549.101 29(15)*	923.31	0.183E-21	R(67) A
27	546.548 62(25)	1263.97	0.316E-22	R(60) C	62	549.159 95(24)	1418.62	0.167E-22	R(66) C
28	546.581 75(15)*	959.33	0.785E-22	R(46) H	63	549.263 02(15)*	1079.84	0.480E-22	R(52) H
29	546.759 81(25)	1238.86	0.441E-22	R(59) B	64	549.478 98(24)	1390.93	0.247E-22	R(65) B
30	546.795 04(16)	848.22	0.109E-22	R(65) P	65	549.537 82(15)*	950.85	0.164E-21	R(68) A
31	546.816 25(17)	1545.35	0.113E-22	R(49) G	66	549.596 51(24)	1445.81	0.149E-22	R(67) C
32	546.924 49(15)*	791.70	0.316E-21	R(62) A	67	549.713 22(15)*	1101.34	0.438E-22	R(53) H
33	546.927 02(24)	1761.33	0.456E-23	R(59) F	68	549.933 63(24)	1417.69	0.222E-22	R(66) B
34	546.982 87(25)	1288.73	0.286E-22	R(61) C	69	549.974 74(15)*	978.78	0.145E-21	R(69) A
35	547.018 52(23)	1761.24	0.461E-23	R(59) E	70	550.033 46(24)	1473.41	0.133E-22	R(68) C

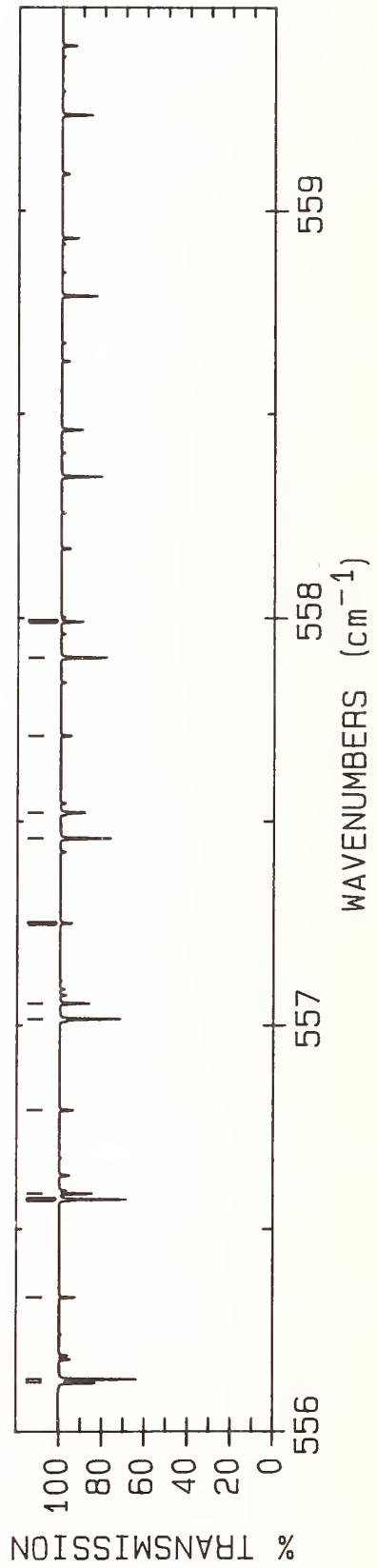
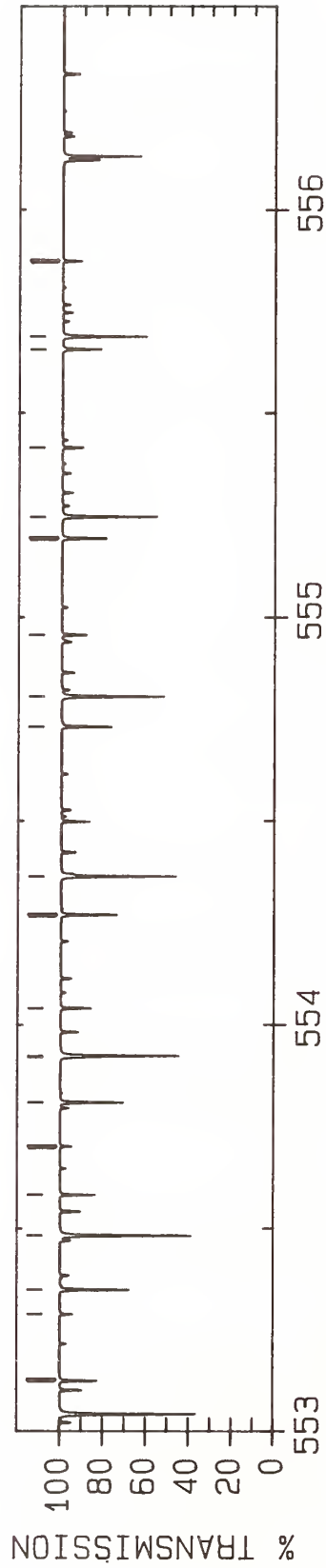
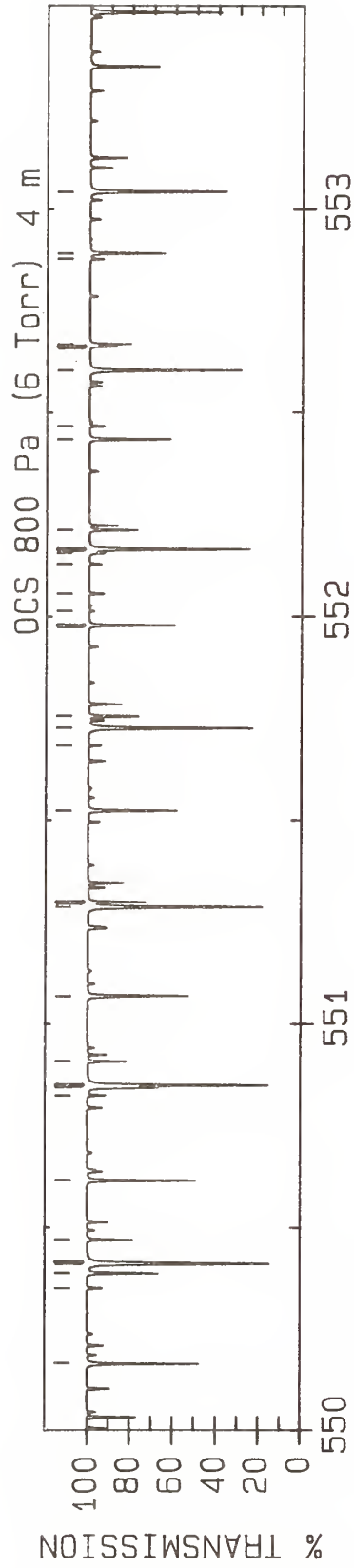

LINE #	WAVENUMBER(unc) (cm ⁻¹)	LOWER STATE (cm ⁻¹)	INTENSITY (cm/molecule)	ASSIGNMENT ROTATION BAND	LINE #	WAVENUMBER(unc) (cm ⁻¹)	LOWER STATE (cm ⁻¹)	INTENSITY (cm/molecule)	ASSIGNMENT ROTATION BAND
1	550.164 38(15)*	1123.25	0.399E-22	R(54) H	36	553.290 13(28)	1580.76	0.312E-23	R(51) I
2	550.350 99(28)	1408.78	0.409E-23	R(42) J	37	553.350 44(15)*	1287.93	0.193E-22	R(61) H
3	550.388 66(24)	1444.85	0.200E-22	R(67) B	38	553.483 70(15)*	1216.79	0.527E-22	R(77) A
4	550.412 04(15)*	1007.13	0.129E-21	R(70) A	39	553.583 47(24)	1646.29	0.893E-23	R(74) B
5	550.415 20(28)	1444.14	0.481E-23	R(44) I	40	553.702 00(27)	1601.90	0.290E-23	R(52) I
6	550.470 79(24)	1501.41	0.118E-22	R(69) C	41	553.809 69(15)*	1313.07	0.172E-22	R(62) H
7	550.616 53(15)*	1145.56	0.362E-22	R(55) H	42	553.920 41(28)	1560.08	0.233E-23	R(50) J
8	550.825 12(28)	1462.44	0.455E-23	R(45) I	43	553.923 99(15)*	1248.35	0.460E-22	R(78) A
9	550.844 06(24)	1472.41	0.179E-22	R(68) B	44	554.041 08(24)	1676.68	0.789E-23	R(75) B
10	550.849 72(15)*	1035.87	0.114E-21	R(71) A	45	554.269 99(15)*	1338.62	0.153E-22	R(63) H
11	550.908 49(24)	1529.81	0.105E-22	R(70) C	46	554.364 64(15)*	1280.32	0.400E-22	R(79) A
12	551.067 08(28)	1126.67	0.339E-23	R(75) P	47	554.731 35(15)*	1364.57	0.136E-22	R(64) H
13	551.069 66(15)*	1168.28	0.328E-22	R(56) H	48	554.805 66(15)*	1312.69	0.348E-22	R(80) A
14	551.287 78(15)*	1065.02	0.101E-21	R(72) A	49	554.957 10(24)	1738.67	0.612E-23	R(77) B
15	551.299 81(24)	1500.39	0.160E-22	R(69) B	50	555.193 78(15)*	1390.93	0.120E-22	R(65) H
16	551.523 78(15)*	1191.40	0.297E-22	R(57) H	51	555.247 03(16)*	1345.46	0.301E-22	R(81) A
17	551.683 14(28)	1462.47	0.338E-23	R(45) J	52	555.415 48(24)	1770.28	0.537E-23	R(78) B
18	551.726 22(15)*	1094.57	0.891E-22	R(73) A	53	555.657 29(15)*	1417.69	0.106E-22	R(66) H
19	551.755 91(24)	1528.76	0.143E-22	R(70) B	54	555.688 76(16)*	1378.63	0.261E-22	R(82) A
20	551.978 92(15)*	1214.93	0.267E-22	R(58) H	55	555.874 09(24)	1802.28	0.470E-23	R(79) B
21	552.014 03(28)	2051.69	0.142E-23	R(70) E	56	556.121 89(15)*	1444.85	0.935E-23	R(67) H
22	552.056 38(28)	1519.78	0.381E-23	R(48) I	57	556.130 85(16)*	1412.21	0.225E-22	R(83) A
23	552.128 89(28)	1481.18	0.315E-23	R(46) J	58	556.332 92(24)	1834.68	0.411E-23	R(80) B
24	552.155 67(18)	1841.28	0.335E-23	R(62) G	59	556.570 19(36)	1559.93	0.231E-24	R(72) S
25	552.165 03(15)*	1124.52	0.783E-22	R(74) A	60	556.573 29(16)*	1446.18	0.194E-22	R(84) A
26	552.212 34(24)	1557.54	0.128E-22	R(71) B	61	556.587 58(15)*	1472.41	0.821E-23	R(68) H
27	552.435 06(15)*	1238.86	0.240E-22	R(59) H	62	556.791 95(24)	1867.49	0.358E-23	R(81) B
28	552.467 33(28)	1539.70	0.357E-23	R(49) I	63	557.016 08(16)*	1480.56	0.166E-22	R(85) A
29	552.604 22(15)*	1154.87	0.688E-22	R(75) A	64	557.054 39(15)*	1500.39	0.720E-23	R(69) H
30	552.663 01(24)	1647.46	0.635E-23	R(74) C	65	557.251 18(24)	1900.71	0.312E-23	R(82) B
31	552.669 08(24)	1586.72	0.114E-22	R(72) B	66	557.459 22(17)	1515.34	0.143E-22	R(86) A
32	552.878 58(28)	1560.03	0.334E-23	R(50) I	67	557.522 31(15)*	1528.76	0.629E-23	R(70) H
33	552.892 24(15)*	1263.19	0.215E-22	R(60) H	68	557.710 59(24)	1934.32	0.271E-23	R(83) B
34	553.043 77(15)*	1185.63	0.603E-22	R(76) A	69	557.902 70(17)	1550.53	0.122E-22	R(87) A
35	553.126 13(24)	1616.30	0.101E-22	R(73) B	70	557.991 36(15)*	1557.54	0.549E-23	R(71) H

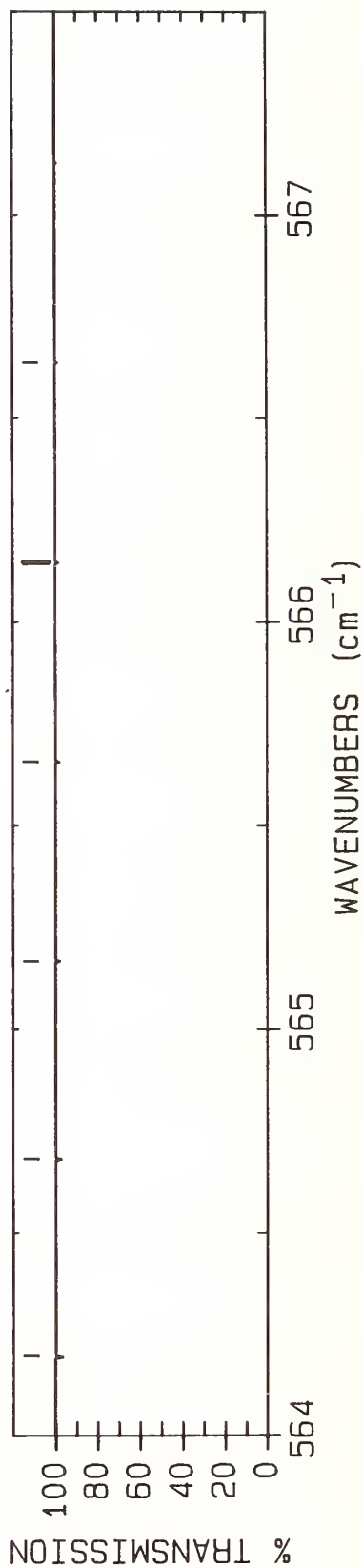
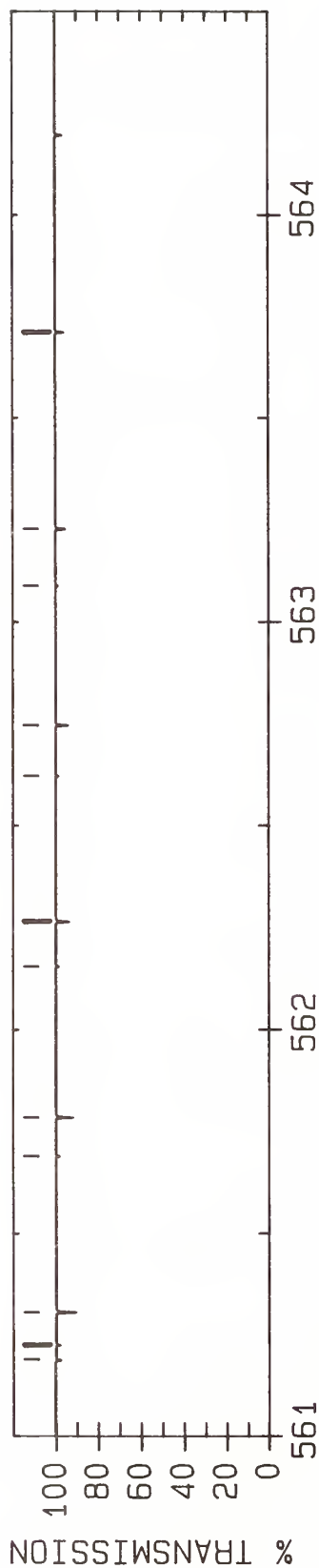
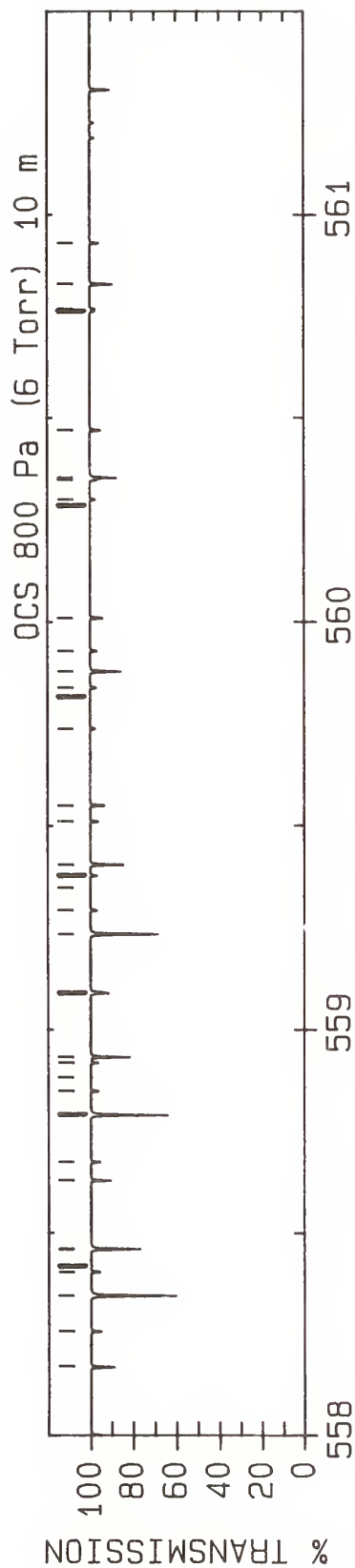

LINE #	WAVENUMBER(unc) (cm ⁻¹)	LOWER STATE (cm ⁻¹)	INTENSITY (cm/molecule)	ASSIGNMENT ROTATION BAND	LINE #	WAVENUMBER(unc) (cm ⁻¹)	LOWER STATE (cm ⁻¹)	INTENSITY (cm/molecule)	ASSIGNMENT ROTATION BAND
1	558.170 18(25)	1968.34	0.235E-23	R(84) B	31	560.300 32(26)	1887.33	0.587E-24	R(64) J
2	558.258 11(26)	1861.19	0.113E-23	R(63) I	32	560.348 39(26)	1995.24	0.673E-24	R(68) I
3	558.346 52(17)	1586.11	0.104E-22	R(88) A	33	560.353 79(16)*	1707.48	0.267E-23	R(76) H
4	558.404 76(27)	2074.42	0.983E-24	R(87) C	34	560.470 34(26)	2144.46	0.111E-23	R(89) B
5	558.418 11(42)	1677.74	0.131E-24	R(76) S	35	560.762 67(26)	1913.74	0.522E-24	R(65) J
6	558.459 85(27)	1785.72	0.914E-24	R(60) J	36	560.768 21(27)	2023.26	0.602E-24	R(69) I
7	558.461 54(15)*	1586.72	0.478E-23	R(72) H	37	560.829 77(16)*	1738.67	0.229E-23	R(77) H
8	558.629 92(25)	2002.76	0.203E-23	R(85) B	38	560.930 75(27)	2180.89	0.949E-24	R(90) B
9	558.675 06(26)	1887.19	0.103E-23	R(64) I	39	561.188 66(27)	2051.69	0.537E-24	R(70) I
10	558.790 69(18)	1622.10	0.890E-23	R(89) A	40	561.225 93(26)	1940.56	0.464E-24	R(66) J
11	558.848 84(27)	2110.08	0.839E-24	R(88) C	41	561.306 95(16)*	1770.28	0.197E-23	R(78) H
12	558.882 94(43)	1708.18	0.113E-24	R(77) S	42	561.690 09(26)	1967.78	0.411E-24	R(67) J
13	558.918 63(26)	1810.52	0.821E-24	R(61) J	43	561.785 31(16)*	1802.28	0.168E-23	R(79) H
14	558.932 86(15)*	1616.30	0.414E-23	R(73) H	44	562.155 16(26)	1995.41	0.363E-24	R(68) J
15	559.089 83(25)	2037.58	0.175E-23	R(86) B	45	562.264 87(16)*	1834.68	0.143E-23	R(80) H
16	559.092 54(26)	1913.60	0.926E-24	R(65) I	46	562.621 14(26)	2023.44	0.320E-24	R(69) J
17	559.235 20(18)	1658.48	0.757E-23	R(90) A	47	562.745 65(17)*	1867.49	0.122E-23	R(81) H
18	559.293 26(28)	2146.15	0.714E-24	R(89) C	48	563.088 03(26)	2051.88	0.281E-24	R(70) J
19	559.348 94(45)	1739.01	0.971E-25	R(78) S	49	563.227 64(17)*	1900.71	0.104E-23	R(82) H
20	559.378 30(26)	1835.71	0.736E-24	R(62) J	50	563.710 85(17)*	1934.32	0.876E-24	R(83) H
21	559.405 34(15)*	1646.29	0.359E-23	R(74) H	51	564.195 29(17)*	1968.34	0.740E-24	R(84) H
22	559.510 58(26)	1940.41	0.834E-24	R(66) I	52	564.680 97(18)*	2002.76	0.624E-24	R(85) H
23	559.549 87(26)	2072.80	0.151E-23	R(87) B	53	565.167 89(18)	2037.58	0.524E-24	R(86) H
24	559.738 00(28)	2182.61	0.607E-24	R(90) C	54	565.656 06(19)	2072.80	0.440E-24	R(87) H
25	559.816 09(47)	1770.23	0.833E-25	R(79) S	55	566.145 48(20)	2108.43	0.368E-24	R(88) H
26	559.838 86(26)	1861.32	0.658E-24	R(63) J	56	566.636 16(20)	2144.46	0.307E-24	R(89) H
27	559.878 98(16)*	1676.68	0.310E-23	R(75) H					
28	559.929 19(26)	1967.62	0.750E-24	R(67) I					
29	560.010 04(26)	2108.43	0.130E-23	R(88) B					
30	560.284 42(48)	1801.85	0.713E-25	R(80) S					

ATLAS OF OCS ABSORPTION LINES FROM 812 cm⁻¹ to 890 cm⁻¹

key:

Band	Isotopomer	Vibrational Transition
A	¹⁶ O ¹² C ³² S	00 ⁰ 1-00 ⁰ 0
B		01 ¹ 1-01 ^{1e} 0
C		01 ¹ 1-01 ^{1f} 0
D		00 ⁰ 2-00 ⁰ 1
E		02 ² 1-02 ^{2e} 0
F		02 ² 1-02 ^{2f} 0
G		02 ⁰ 1-02 ⁰ 0
H		01 ¹ 2-01 ^{1e} 1
I		01 ¹ 2-01 ^{1f} 1
L	¹⁶ O ¹² C ³³ S	00 ⁰ 1-00 ⁰ 0
P	¹⁶ O ¹² C ³⁴ S	00 ⁰ 1-00 ⁰ 0
Q		01 ¹ 1-01 ^{1e} 0
R		01 ¹ 1-01 ^{1f} 0
T	¹⁶ O ¹³ C ³² S	00 ⁰ 1-00 ⁰ 0

If the e or f designation is not specified (for $l \neq 0$), then the transition is to either level, depending on the selection rules and the change in the rotational quantum number, J . Spectra are given for a slitwidth of 0.002 cm⁻¹ and a transition moment of 0.064 debye at a temperature of 296 K. No Herman-Wallis constant was included in the intensity calculation.

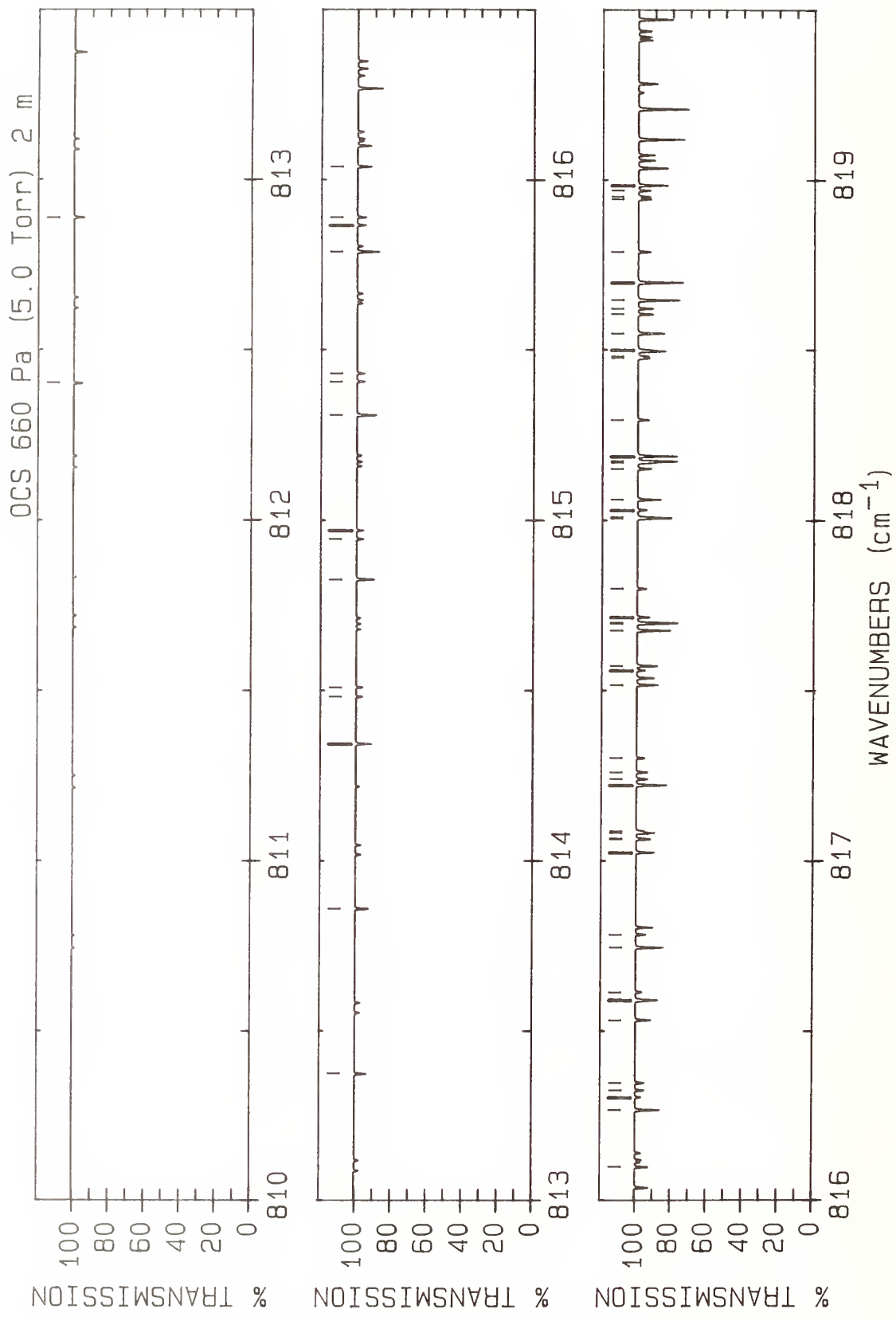

LINE #	WAVENUMBER(unc) (cm ⁻¹)	LOWER STATE (cm ⁻¹)	INTENSITY (cm/molecule)	ASSIGNMENT ROTATION BAND	LINE #	WAVENUMBER(unc) (cm ⁻¹)	LOWER STATE (cm ⁻¹)	INTENSITY (cm/molecule)	ASSIGNMENT ROTATION BAND	LINE #	WAVENUMBER(unc) (cm ⁻¹)	LOWER STATE (cm ⁻¹)	INTENSITY (cm/molecule)	ASSIGNMENT ROTATION BAND
1	812.400 81(11)	1280.64	0.716E-23	P(80)	36	817.240 54(16)	1151.69	0.945E-23	P(56)	Q				
2	812.888 21(11)	1249.06	0.825E-23	P(79)	37	817.260 47(16)	1152.34	0.942E-23	P(56)	R				
3	813.374 45(10)	1217.87	0.948E-23	P(78)	38	817.302 26(7)*	2072.09	0.684E-23	P(77)	D				
4	813.859 54(10)	1187.08	0.109E-22	P(77)	39	817.516 53(11)*	1738.67	0.174E-22	P(77)	B				
5	814.343 47(10)	1156.68	0.125E-22	P(76)	40	817.559 36(31)	1887.33	0.702E-23	P(64)	F				
6	814.482 27(18)	1292.95	0.525E-23	P(62)	41	817.572 10(25)*	1739.94	0.173E-22	P(77)	C				
7	814.508 98(19)	1293.74	0.523E-23	P(62)	42	817.676 43(10)*	1658.48	0.299E-22	P(90)	A				
8	814.826 24(10)*	1126.67	0.142E-22	P(75)	43	817.696 46(16)	1129.53	0.103E-22	P(55)	Q				
9	814.944 69(18)	1268.42	0.582E-23	P(61)	44	817.698 59(9)*	954.88	0.303E-22	P(69)	P				
10	814.970 22(18)	1269.19	0.580E-23	P(61)	45	817.715 34(16)	1130.15	0.103E-22	P(55)	R				
11	815.307 86(9)*	1097.06	0.162E-22	P(74)	46	817.799 06(7)*	2041.03	0.785E-23	P(76)	D				
12	815.406 02(17)	1244.29	0.644E-23	P(60)	47	818.006 36(10)	1841.28	0.851E-23	P(62)	G				
13	815.430 39(18)	1245.03	0.642E-23	P(60)	48	818.006 96(11)*	1707.48	0.200E-22	P(76)	B				
14	815.788 31(9)*	1067.84	0.185E-22	P(73)	49	818.009 52(23)	1861.19	0.784E-23	P(63)	E				
15	815.866 28(17)	1220.55	0.711E-23	P(59)	50	818.030 27(31)	1861.32	0.784E-23	P(63)	F				
16	815.889 51(17)	1221.27	0.709E-23	P(59)	51	818.060 85(23)*	1708.71	0.198E-22	P(76)	C				
17	816.038 51(13)*	1834.68	0.113E-22	P(80)	52	818.151 30(15)	1107.77	0.113E-22	P(54)	Q				
18	816.099 21(30)*	1836.05	0.112E-22	P(80)	53	818.169 15(16)	1108.37	0.113E-22	P(54)	R				
19	816.267 62(9)*	1039.01	0.210E-22	P(72)	54	818.173 27(8)*	927.63	0.341E-22	P(68)	P				
20	816.305 01(7)*	2135.43	0.515E-23	P(79)	55	818.188 13(9)*	1622.10	0.353E-22	P(89)	A				
21	816.325 45(16)	1197.20	0.784E-23	P(58)	56	818.294 64(7)*	2010.36	0.900E-23	P(75)	D				
22	816.347 56(17)	1197.89	0.781E-23	P(58)	57	818.475 46(10)	1816.08	0.947E-23	P(61)	G				
23	816.532 30(12)*	1802.28	0.131E-22	P(79)	58	818.480 82(23)	1835.60	0.875E-23	P(62)	E				
24	816.589 03(22)	1940.41	0.558E-23	P(66)	59	818.496 27(10)*	1676.68	0.229E-22	P(75)	B				
25	816.591 28(28)*	1803.61	0.130E-22	P(79)	60	818.500 15(30)	1835.71	0.874E-23	P(62)	F				
26	816.593 19(10)	1919.30	0.610E-23	P(65)	61	818.548 51(22)*	1677.89	0.228E-22	P(75)	C				
27	816.614 45(33)	1940.56	0.558E-23	P(66)	62	818.605 06(15)	1086.39	0.123E-22	P(53)	Q				
28	816.745 76(9)*	1010.57	0.238E-22	P(71)	63	818.621 90(16)	1086.97	0.123E-22	P(53)	R				
29	816.783 53(16)	1174.25	0.862E-23	P(57)	64	818.646 80(8)*	900.76	0.383E-22	P(67)	P				
30	817.024 98(12)*	1770.28	0.151E-22	P(78)	65	818.698 64(9)*	1586.11	0.417E-22	P(88)	A				
31	817.063 63(22)	1913.60	0.626E-23	P(65)	66	818.789 01(7)*	1980.10	0.103E-22	P(74)	D				
32	817.065 22(10)	1892.89	0.683E-23	P(64)	67	818.943 58(10)	1791.29	0.105E-22	P(60)	G				
33	817.082 24(26)*	1771.58	0.150E-22	P(78)	68	818.951 02(23)	1810.40	0.973E-23	P(61)	E				
34	817.087 42(32)	1913.74	0.626E-23	P(65)	69	818.969 01(30)	1810.52	0.973E-23	P(61)	F				
35	817.222 76(9)*	982.53	0.269E-22	P(70)	70	818.984 46(10)*	1646.29	0.262E-22	P(74)	B				

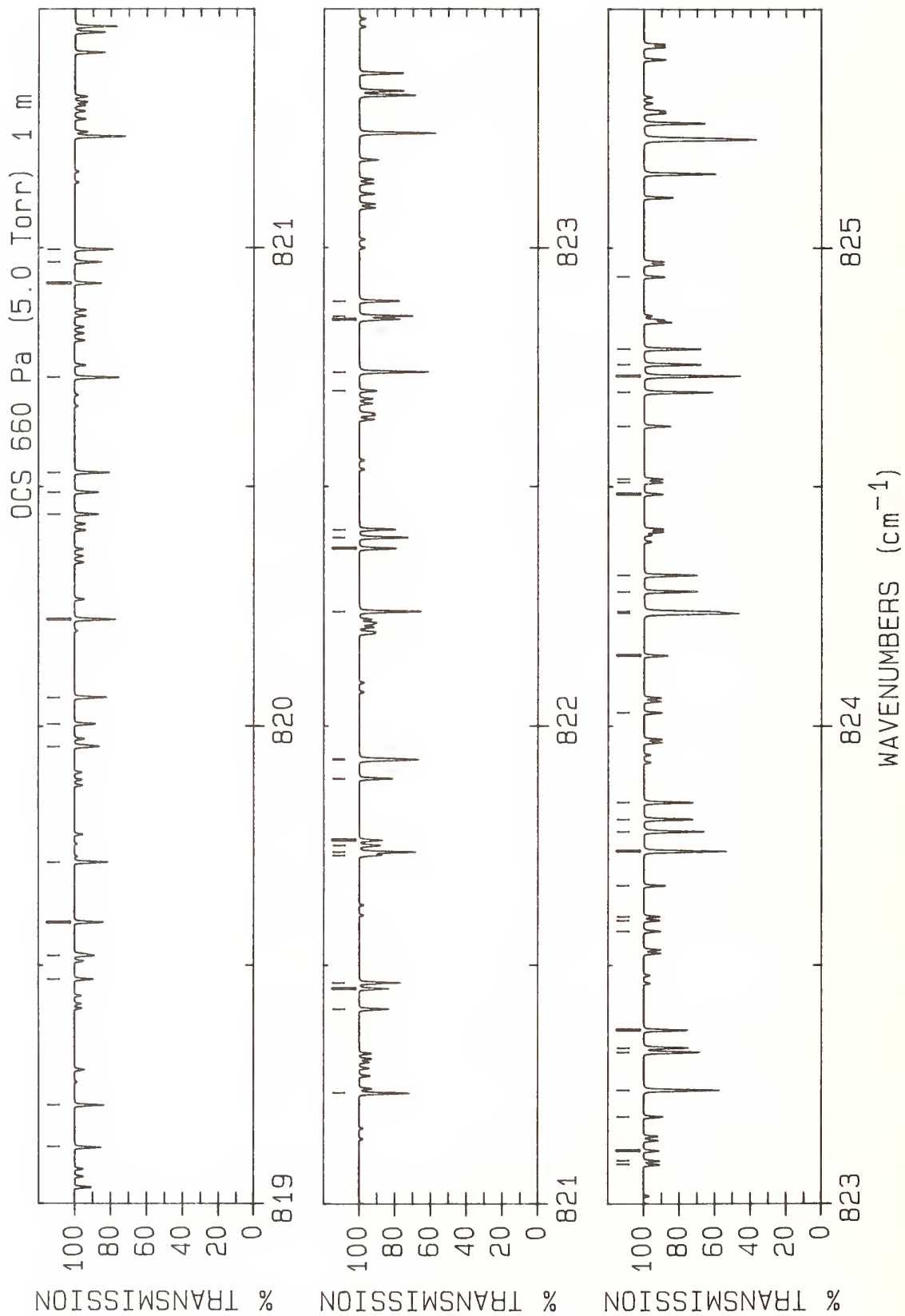

LINE #	WAVENUMBER(unc) (cm ⁻¹)	LOWER STATE (cm ⁻¹)	INTENSITY (cm/molecule)	ASSIGNMENT ROTATION BAND	LINE #	WAVENUMBER(unc) (cm ⁻¹)	LOWER STATE (cm ⁻¹)	INTENSITY (cm/molecule)	ASSIGNMENT ROTATION BAND
1	819.119 17(8)*	874.29	0.430E-22	P(66)	36	822.856 61(7)*	676.72	0.991E-22	P(58)
2	819.207 95(8)*	1550.53	0.490E-22	P(87)	37	822.887 97(13)*	1418.62	0.710E-22	P(66)
3	819.471 54(9)*	1616.30	0.299E-22	P(73)	38	823.083 23(15)	894.39	0.255E-22	P(43)
4	819.520 51(19)*	1617.44	0.298E-22	P(73)	39	823.091 24(14)	894.77	0.255E-22	P(43)
5	819.590 39(8)*	848.22	0.480E-22	P(65)	40	823.112 45(10)	1586.42	0.243E-22	P(51)
6	819.716 06(7)*	1515.34	0.575E-22	P(86)	41	823.183 64(7)*	1725.81	0.313E-22	P(65)
7	819.957 49(9)*	1586.72	0.341E-22	P(72)	42	823.239 40(5)*	1280.32	0.166E-21	P(79)
8	820.004 86(18)*	1587.83	0.339E-22	P(72)	43	823.318 59(7)*	653.80	0.109E-21	P(57)
9	820.060 46(8)*	822.54	0.536E-22	P(64)	44	823.327 97(7)*	1390.93	0.801E-22	P(65)
10	820.222 97(7)*	1480.56	0.674E-22	P(85)	45	823.364 66(12)*	1391.83	0.797E-22	P(65)
11	820.442 33(9)*	1557.54	0.388E-22	P(71)	46	823.570 72(10)	1565.68	0.264E-22	P(50)
12	820.488 11(17)*	1558.62	0.386E-22	P(71)	47	823.593 45(25)	1580.76	0.250E-22	P(51)
13	820.529 37(8)*	797.25	0.597E-22	P(63)	48	823.601 43(28)	1580.82	0.250E-22	P(51)
14	820.728 70(7)*	1446.18	0.787E-22	P(84)	49	823.665 87(7)*	1699.57	0.350E-22	P(64)
15	820.926 06(8)*	1528.76	0.440E-22	P(70)	50	823.737 96(5)*	1248.35	0.192E-21	P(78)
16	820.970 27(16)*	1529.81	0.438E-22	P(70)	51	823.779 43(6)*	631.27	0.119E-21	P(56)
17	820.997 12(7)*	772.36	0.664E-22	P(62)	52	823.805 02(7)*	1364.57	0.897E-22	P(64)
18	821.233 22(6)*	1412.21	0.918E-22	P(83)	53	823.840 27(12)*	1365.45	0.893E-22	P(64)
19	821.408 67(8)*	1500.39	0.498E-22	P(69)	54	824.028 00(10)	1545.35	0.286E-22	P(49)
20	821.451 34(15)*	1501.41	0.496E-22	P(69)	55	824.146 89(7)*	1673.73	0.391E-22	P(63)
21	821.463 72(7)*	747.86	0.736E-22	P(61)	56	824.235 33(5)*	1216.79	0.221E-21	P(77)
22	821.729 69(7)*	1806.96	0.220E-22	P(68)	57	824.239 11(6)*	609.13	0.131E-21	P(55)
23	821.736 56(6)*	1378.63	0.107E-21	P(82)	58	824.280 96(7)*	1338.62	0.100E-21	P(63)
24	821.751 12(15)	947.84	0.210E-22	P(46)	59	824.314 79(11)*	1339.47	0.998E-22	P(63)
25	821.761 52(14)	948.28	0.210E-22	P(46)	60	824.484 28(10)	1525.43	0.309E-22	P(48)
26	821.890 16(8)*	1472.41	0.563E-22	P(68)	61	824.509 09(26)	1539.70	0.293E-22	P(49)
27	821.929 17(7)*	723.75	0.815E-22	P(60)	62	824.515 71(28)	1539.75	0.293E-22	P(49)
28	821.931 30(15)*	1473.41	0.560E-22	P(68)	63	824.626 69(7)*	1648.29	0.436E-22	P(62)
29	822.238 70(6)*	1345.46	0.124E-21	P(81)	64	824.697 64(6)*	587.39	0.143E-21	P(54)
30	822.370 55(8)*	1444.85	0.634E-22	P(67)	65	824.731 52(5)*	1185.63	0.254E-21	P(76)
31	822.393 47(7)*	700.04	0.899E-22	P(59)	66	824.755 78(7)*	1313.07	0.112E-21	P(62)
32	822.410 18(14)*	1445.81	0.631E-22	P(67)	67	824.788 22(11)*	1313.90	0.111E-21	P(62)
33	822.700 20(7)*	1752.46	0.279E-22	P(66)	68	824.939 56(10)	1505.91	0.332E-22	P(47)
34	822.739 64(6)*	1312.69	0.144E-21	P(80)					
35	822.849 82(7)*	1417.69	0.714E-22	P(66)					

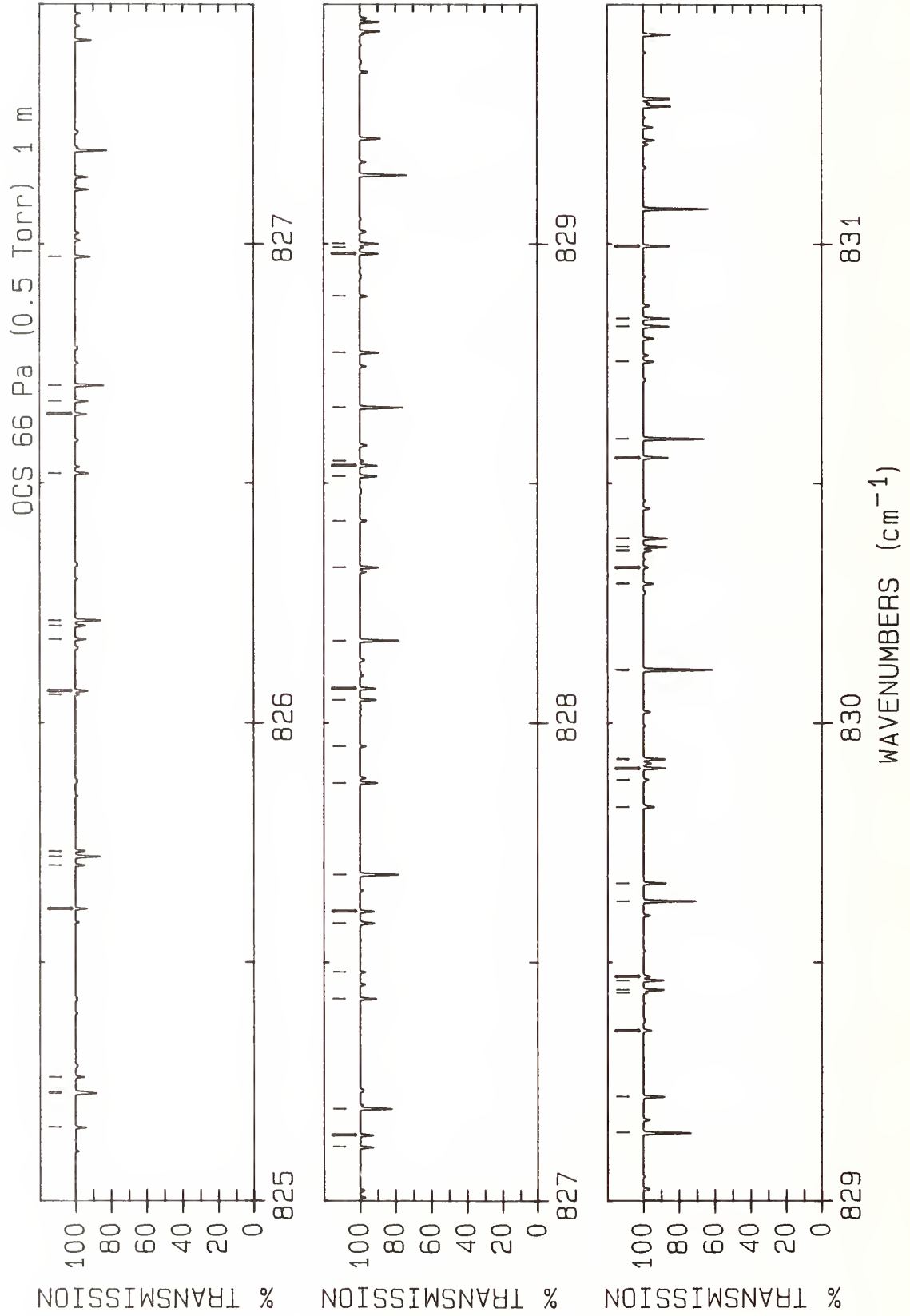

LINE #	WAVENUMBER(unc) (cm ⁻¹)	LOWER STATE (cm ⁻¹)	INTENSITY (cm/molecule)	ASSIGNMENT ROTATION BAND	LINE #	WAVENUMBER(unc) (cm ⁻¹)	LOWER STATE (cm ⁻¹)	INTENSITY (cm/molecule)	ASSIGNMENT ROTATION BAND	LINE #	WAVENUMBER(unc) (cm ⁻¹)	LOWER STATE (cm ⁻¹)	INTENSITY (cm/molecule)	ASSIGNMENT ROTATION BAND
1	825.155 01(6)*	566.04	0.155E-21	P(53)	36	828.545 78(10)	1364.38	0.551E-22	P(39)	36	828.545 78(10)	1364.38	0.551E-22	P(39)
2	825.226 51(5)*	1154.87	0.291E-21	P(75)	37	828.658 15(5)*	950.85	0.715E-21	P(68)	37	828.658 15(5)*	950.85	0.715E-21	P(68)
3	825.229 50(7)*	1287.93	0.124E-21	P(61)	38	828.772 47(5)*	409.47	0.284E-21	P(45)	38	828.772 47(5)*	409.47	0.284E-21	P(45)
4	825.260 56(10)*	1288.73	0.124E-21	P(61)	39	828.890 47(7)*	1437.45	0.104E-21	P(53)	39	828.890 47(7)*	1437.45	0.104E-21	P(53)
5	825.611 23(6)*	545.09	0.169E-21	P(52)	40	828.979 37(7)*	1101.34	0.269E-21	P(53)	40	828.979 37(7)*	1101.34	0.269E-21	P(53)
6	825.702 11(7)*	1263.19	0.138E-21	P(60)	41	828.992 03(10)	1348.52	0.581E-22	P(38)	41	828.992 03(10)	1348.52	0.581E-22	P(38)
7	825.720 31(5)*	1124.52	0.333E-21	P(74)	42	829.000 29(8)*	1101.95	0.268E-21	P(53)	42	829.000 29(8)*	1101.95	0.268E-21	P(53)
8	825.731 82(10)*	1263.97	0.137E-21	P(60)	43	829.143 63(5)*	923.31	0.806E-21	P(67)	43	829.143 63(5)*	923.31	0.806E-21	P(67)
9	826.058 84(7)*	1574.38	0.595E-22	P(59)	44	829.219 47(5)*	391.68	0.303E-21	P(44)	44	829.219 47(5)*	391.68	0.303E-21	P(44)
10	826.066 30(6)*	524.53	0.183E-21	P(51)	45	829.358 18(7)*	1416.04	0.114E-21	P(52)	45	829.358 18(7)*	1416.04	0.114E-21	P(52)
11	826.173 61(7)*	1238.86	0.153E-21	P(59)	46	829.437 27(10)	1333.06	0.610E-22	P(37)	46	829.437 27(10)	1333.06	0.610E-22	P(37)
12	826.201 99(9)*	1239.61	0.152E-21	P(59)	47	829.443 13(7)*	1079.84	0.293E-21	P(52)	47	829.443 13(7)*	1079.84	0.293E-21	P(52)
13	826.212 92(5)*	1094.57	0.381E-21	P(73)	48	829.462 90(8)*	1080.42	0.292E-21	P(52)	48	829.462 90(8)*	1080.42	0.292E-21	P(52)
14	826.520 21(6)*	504.37	0.198E-21	P(50)	49	829.469 99(28)	1342.85	0.596E-22	P(38)	49	829.469 99(28)	1342.85	0.596E-22	P(38)
15	826.644 00(7)*	1214.93	0.169E-21	P(58)	50	829.471 92(28)	1342.87	0.596E-22	P(38)	50	829.471 92(28)	1342.87	0.596E-22	P(38)
16	826.671 08(9)*	1215.65	0.168E-21	P(58)	51	829.627 93(5)*	896.18	0.907E-21	P(66)	51	829.627 93(5)*	896.18	0.907E-21	P(66)
17	826.704 34(5)*	1065.02	0.434E-21	P(72)	52	829.665 30(5)*	374.27	0.322E-21	P(43)	52	829.665 30(5)*	374.27	0.322E-21	P(43)
18	826.972 97(5)*	484.60	0.214E-21	P(49)	53	829.824 67(7)*	1395.03	0.124E-21	P(51)	53	829.824 67(7)*	1395.03	0.124E-21	P(51)
19	827.113 29(7)*	1191.40	0.186E-21	P(57)	54	829.881 50(10)	1318.01	0.639E-22	P(36)	54	829.881 50(10)	1318.01	0.639E-22	P(36)
20	827.139 08(9)*	1192.10	0.186E-21	P(57)	55	829.905 78(7)*	1058.74	0.318E-21	P(51)	55	829.905 78(7)*	1058.74	0.318E-21	P(51)
21	827.194 58(5)*	1035.87	0.493E-21	P(71)	56	829.924 42(7)*	1059.31	0.318E-21	P(51)	56	829.924 42(7)*	1059.31	0.318E-21	P(51)
22	827.424 58(5)*	465.23	0.231E-21	P(48)	57	830.109 99(5)*	357.27	0.342E-21	P(42)	57	830.109 99(5)*	357.27	0.342E-21	P(42)
23	827.480 10(7)*	1504.10	0.797E-22	P(56)	58	830.111 04(5)*	869.46	0.102E-20	P(65)	58	830.111 04(5)*	869.46	0.102E-20	P(65)
24	827.581 46(7)*	1168.28	0.205E-21	P(56)	59	830.289 96(7)*	1374.42	0.134E-21	P(50)	59	830.289 96(7)*	1374.42	0.134E-21	P(50)
25	827.606 01(8)*	1168.96	0.204E-21	P(56)	60	830.324 71(10)	1303.37	0.667E-22	P(35)	60	830.324 71(10)	1303.37	0.667E-22	P(35)
26	827.683 62(5)*	1007.13	0.559E-21	P(70)	61	830.358 47(28)	1312.34	0.655E-22	P(36)	61	830.358 47(28)	1312.34	0.655E-22	P(36)
27	827.875 03(5)*	446.25	0.248E-21	P(47)	62	830.359 93(28)	1312.36	0.655E-22	P(36)	62	830.359 93(28)	1312.36	0.655E-22	P(36)
28	827.951 43(7)*	1481.48	0.874E-22	P(55)	63	830.367 33(7)*	1038.05	0.345E-21	P(50)	63	830.367 33(7)*	1038.05	0.345E-21	P(50)
29	828.048 54(7)*	1145.56	0.225E-21	P(55)	64	830.384 87(7)*	1038.59	0.344E-21	P(50)	64	830.384 87(7)*	1038.59	0.344E-21	P(50)
30	828.071 85(8)*	1146.22	0.224E-21	P(55)	65	830.553 51(5)*	340.66	0.362E-21	P(41)	65	830.553 51(5)*	340.66	0.362E-21	P(41)
31	828.171 48(5)*	978.78	0.633E-21	P(69)	66	830.592 96(5)*	843.13	0.114E-20	P(64)	66	830.592 96(5)*	843.13	0.114E-20	P(64)
32	828.324 33(5)*	427.66	0.266E-21	P(46)	67	830.754 05(7)*	1354.22	0.145E-21	P(49)	67	830.754 05(7)*	1354.22	0.145E-21	P(49)
33	828.421 56(7)*	1459.26	0.956E-22	P(54)	68	830.827 77(7)*	1017.76	0.374E-21	P(49)	68	830.827 77(7)*	1017.76	0.374E-21	P(49)
34	828.514 50(7)*	1123.25	0.246E-21	P(54)	69	830.844 24(7)*	1018.28	0.373E-21	P(49)	69	830.844 24(7)*	1018.28	0.373E-21	P(49)
35	828.536 61(8)*	1123.88	0.245E-21	P(54)	70	830.995 89(5)*	324.44	0.383E-21	P(40)	70	830.995 89(5)*	324.44	0.383E-21	P(40)

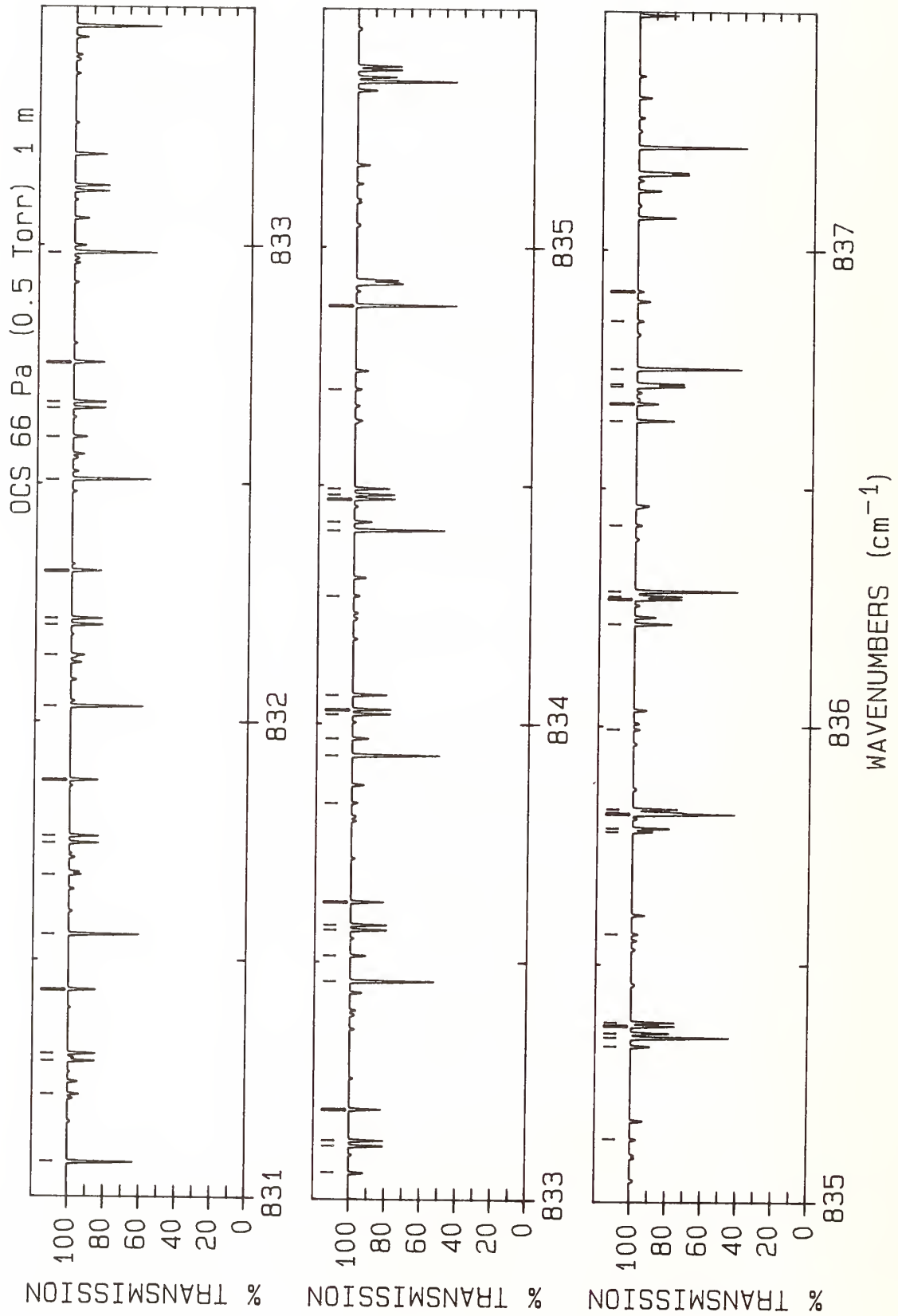

LINE #	WAVENUMBER(unc) (cm ⁻¹)	LOWER STATE (cm ⁻¹)	INTENSITY (cm/molecule)	ASSIGNMENT ROTATION BAND	LINE #	WAVENUMBER(unc) (cm ⁻¹)	LOWER STATE (cm ⁻¹)	INTENSITY (cm/molecule)	ASSIGNMENT ROTATION BAND
1	831.073 70(5)*	817.21	0.127E-20	P(63) A	36	834.060 14(7)*	221.99	0.522E-21	P(33) P
2	831.216 92(7)*	1334.42	0.157E-21	P(48) D	37	834.267 75(10)	1189.87	0.865E-22	P(26) G
3	831.287 11(7)*	997.88	0.404E-21	P(48) B	38	834.405 66(5)*	647.08	0.260E-20	P(56) A
4	831.302 53(7)*	998.38	0.403E-21	P(48) C	39	834.423 18(7)*	1207.11	0.249E-21	P(41) D
5	831.437 10(5)*	308.62	0.403E-21	P(39) P	40	834.471 63(7)*	870.04	0.644E-21	P(41) B
6	831.553 25(5)*	791.70	0.142E-20	P(62) A	41	834.480 46(7)*	870.40	0.643E-21	P(41) C
7	831.678 58(7)*	1315.02	0.168E-21	P(47) D	42	834.493 27(7)*	208.93	0.539E-21	P(32) P
8	831.745 35(7)*	978.40	0.435E-21	P(47) B	43	834.700 74(10)	1179.29	0.876E-22	P(25) G
9	831.759 74(7)*	978.88	0.434E-21	P(47) C	44	834.876 39(7)*	1190.54	0.264E-21	P(40) D
10	831.877 17(6)*	293.19	0.424E-21	P(38) P	45	834.876 91(5)*	624.39	0.285E-20	P(55) A
11	832.031 61(5)*	766.58	0.158E-20	P(61) A	46	835.132 71(10)	1169.12	0.884E-22	P(24) G
12	832.139 04(7)*	1296.03	0.181E-21	P(46) D	47	835.328 38(7)*	1174.37	0.278E-21	P(39) D
13	832.202 49(7)*	959.33	0.467E-21	P(46) B	48	835.346 99(5)*	602.10	0.312E-20	P(54) A
14	832.215 88(7)*	959.78	0.466E-21	P(46) C	49	835.356 05(7)*	184.01	0.571E-21	P(30) P
15	832.316 07(6)*	278.16	0.444E-21	P(37) P	50	835.371 58(7)*	837.16	0.720E-21	P(39) B
16	832.508 79(5)*	741.87	0.175E-20	P(60) A	51	835.378 78(7)*	837.49	0.719E-21	P(39) C
17	832.598 28(7)*	1277.44	0.194E-21	P(45) D	52	835.563 65(10)	1159.35	0.889E-22	P(23) G
18	832.658 52(7)*	940.66	0.501E-21	P(45) B	53	835.779 17(7)*	1158.61	0.293E-21	P(38) D
19	832.670 95(7)*	941.10	0.500E-21	P(45) C	54	835.785 70(8)*	172.14	0.585E-21	P(29) P
20	832.753 83(6)*	263.53	0.464E-21	P(36) P	55	835.815 87(5)*	580.22	0.341E-20	P(53) A
21	832.984 79(5)*	717.57	0.194E-20	P(59) A	56	835.819 89(7)*	821.33	0.758E-21	P(38) B
22	833.056 32(7)*	1259.25	0.207E-21	P(44) D	57	835.826 32(7)*	821.64	0.757E-21	P(38) C
23	833.113 45(7)*	922.39	0.535E-21	P(44) B	58	835.993 55(10)	1149.99	0.890E-22	P(22) G
24	833.124 94(7)*	922.82	0.534E-21	P(44) C	59	836.214 19(8)*	160.67	0.598E-21	P(28) P
25	833.190 42(6)*	249.29	0.484E-21	P(35) P	60	836.267 11(7)*	805.90	0.796E-21	P(37) B
26	833.459 60(5)*	693.67	0.214E-20	P(58) A	61	836.272 80(7)*	806.20	0.795E-21	P(37) C
27	833.513 15(7)*	1241.47	0.221E-21	P(43) D	62	836.283 57(5)*	558.74	0.371E-20	P(52) A
28	833.567 28(7)*	904.54	0.571E-21	P(43) B	63	836.422 43(10)	1141.04	0.888E-22	P(21) G
29	833.577 85(7)*	904.94	0.570E-21	P(43) C	64	836.641 52(8)*	149.59	0.609E-21	P(27) P
30	833.625 86(6)*	235.44	0.503E-21	P(34) P	65	836.677 11(7)*	1128.29	0.322E-21	P(36) D
31	833.833 72(10)	1200.85	0.851E-22	P(27) G	66	836.713 23(7)*	790.88	0.833E-21	P(36) B
32	833.933 22(5)*	670.17	0.236E-20	P(57) A	67	836.718 20(7)*	791.16	0.832E-21	P(36) C
33	833.968 77(7)*	1224.09	0.235E-21	P(42) D	68	836.750 09(5)*	537.67	0.404E-20	P(51) A
34	834.020 01(7)*	887.08	0.607E-21	P(42) B	69	836.850 27(10)	1132.50	0.882E-22	P(20) G
35	834.029 69(7)*	887.47	0.606E-21	P(42) C	70	836.912 82(8)	348.07	0.898E-22	P(41) T

OCS 133 Pa (1.0 Torr) 1 m

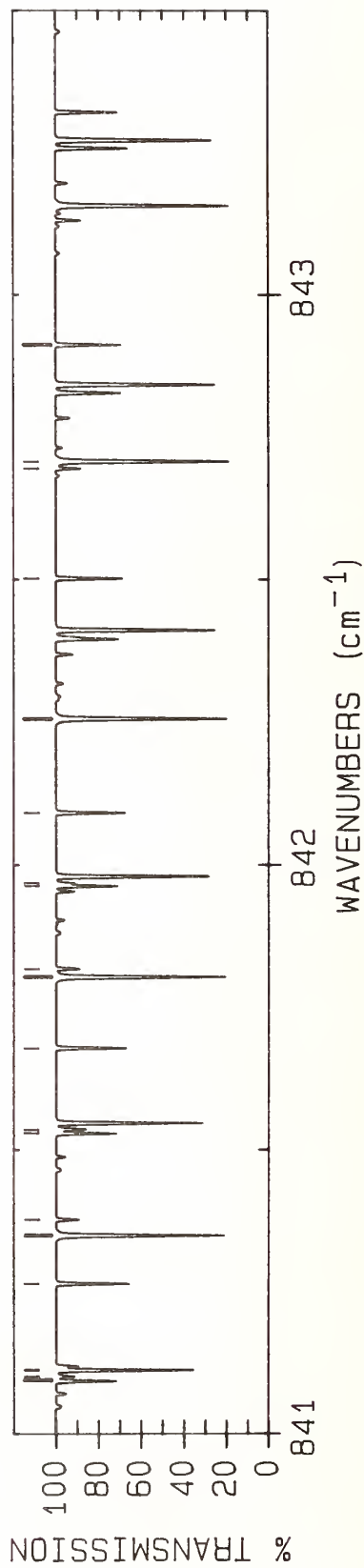
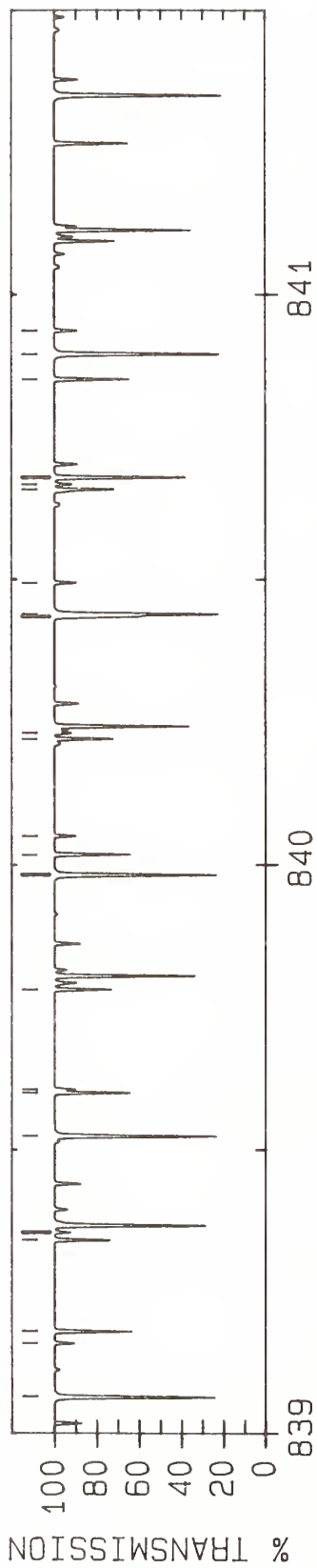
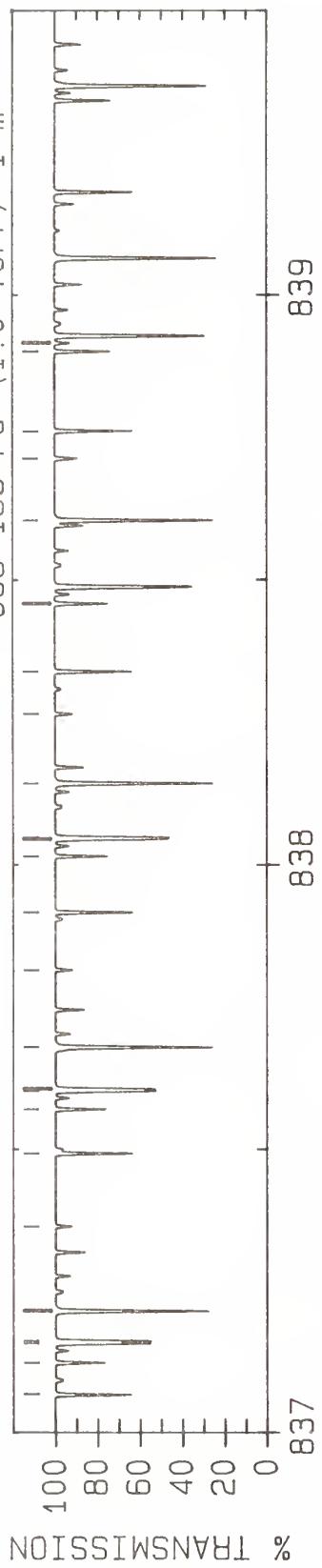

LINE #	WAVENUMBER(unc) (cm ⁻¹)	LOWER STATE (cm ⁻¹)	INTENSITY (cm/molecule)	ASSIGNMENT ROTATION BAND	LINE #	WAVENUMBER(unc) (cm ⁻¹)	LOWER STATE (cm ⁻¹)	INTENSITY (cm/molecule)	ASSIGNMENT ROTATION BAND
1	837.067 70(8)*	138.90	0.618E-21	P(26)	36	840.018 40(10)*	75.19	0.618E-21	P(19)
2	837.124 27(7)*	1113.73	0.336E-21	P(35)	37	840.050 81(7)	240.56	0.126E-21	P(34)
3	837.158 24(7)*	776.26	0.870E-21	P(35)	38	840.220 48(7)*	1023.17	0.419E-21	P(28)
4	837.162 53(7)*	776.53	0.869E-21	P(35)	39	840.230 83(12)	198.66	0.997E-22	P(31)
5	837.215 42(5)*	517.00	0.438E-20	P(50)	40	840.435 28(10)*	67.68	0.607E-21	P(18)
6	837.364 64(8)	331.50	0.951E-22	P(40)	41	840.439 59(5)*	383.65	0.723E-20	P(43)
7	837.492 71(9)*	128.62	0.625E-21	P(25)	42	840.494 39(7)	226.82	0.131E-21	P(33)
8	837.570 21(7)*	1099.58	0.350E-21	P(34)	43	840.657 95(7)*	1011.84	0.427E-21	P(27)
9	837.602 15(7)*	762.05	0.907E-21	P(34)	44	840.666 89(12)	186.25	0.102E-21	P(30)
10	837.605 79(7)*	762.31	0.905E-21	P(34)	45	840.678 57(7)*	674.10	0.111E-20	P(27)
11	837.679 57(5)*	496.74	0.474E-20	P(49)	46	840.678 67(7)*	673.94	0.111E-20	P(27)
12	837.815 28(8)	315.33	0.100E-21	P(39)	47	840.850 99(10)*	60.55	0.594E-21	P(17)
13	837.916 56(9)*	118.72	0.630E-21	P(24)	48	840.895 44(5)*	366.22	0.769E-20	P(42)
14	838.014 95(7)*	1085.84	0.364E-21	P(33)	49	840.936 78(7)	213.48	0.136E-21	P(32)
15	838.044 96(7)*	748.25	0.941E-21	P(33)	50	841.094 20(7)*	1000.93	0.434E-21	P(26)
16	838.047 97(7)*	748.49	0.940E-21	P(33)	51	841.101 78(12)	174.23	0.105E-21	P(29)
17	838.142 53(5)*	476.88	0.512E-20	P(48)	52	841.113 25(7)*	663.13	0.113E-20	P(26)
18	838.264 74(8)	299.57	0.106E-21	P(38)	53	841.113 76(7)*	662.98	0.113E-20	P(26)
19	838.339 25(9)*	109.23	0.632E-21	P(23)	54	841.265 54(11)*	53.83	0.578E-21	P(16)
20	838.458 48(7)*	1072.49	0.376E-21	P(32)	55	841.350 12(5)*	349.19	0.816E-20	P(41)
21	838.604 31(5)*	457.42	0.551E-20	P(47)	56	841.377 99(7)	200.54	0.140E-21	P(31)
22	838.713 02(7)	284.21	0.111E-21	P(37)	57	841.529 25(7)*	990.41	0.440E-21	P(25)
23	838.760 79(9)*	100.13	0.633E-21	P(22)	58	841.535 50(12)	162.62	0.108E-21	P(28)
24	838.900 80(7)*	1059.56	0.388E-21	P(31)	59	841.678 92(11)*	47.49	0.559E-21	P(15)
25	838.915 61(12)	238.30	0.900E-22	P(34)	60	841.803 60(5)*	332.57	0.864E-20	P(40)
26	839.064 91(5)*	438.37	0.592E-20	P(46)	61	841.818 03(7)	188.01	0.144E-21	P(30)
27	839.160 13(7)	269.26	0.116E-21	P(36)	62	841.963 08(7)*	980.30	0.444E-21	P(24)
28	839.181 15(9)*	91.42	0.630E-21	P(21)	63	841.968 04(12)	151.40	0.109E-21	P(27)
29	839.341 90(7)*	1047.02	0.400E-21	P(30)	64	842.091 13(11)*	41.56	0.537E-21	P(14)
30	839.355 19(12)	224.69	0.934E-22	P(33)	65	842.255 90(5)*	316.35	0.912E-20	P(39)
31	839.524 32(5)*	419.73	0.634E-20	P(45)	66	842.256 89(7)	175.88	0.148E-21	P(29)
32	839.600 36(10)*	83.11	0.625E-21	P(20)	67	842.502 18(11)*	36.02	0.513E-21	P(13)
33	839.606 06(7)	254.71	0.121E-21	P(35)	68	842.694 56(7)	164.16	0.151E-21	P(28)
34	839.781 79(7)*	1034.89	0.410E-21	P(29)	69	842.707 02(5)*	300.54	0.960E-20	P(38)
35	839.982 55(5)*	401.49	0.678E-20	P(44)	70	842.912 06(11)*	30.87	0.486E-21	P(12)

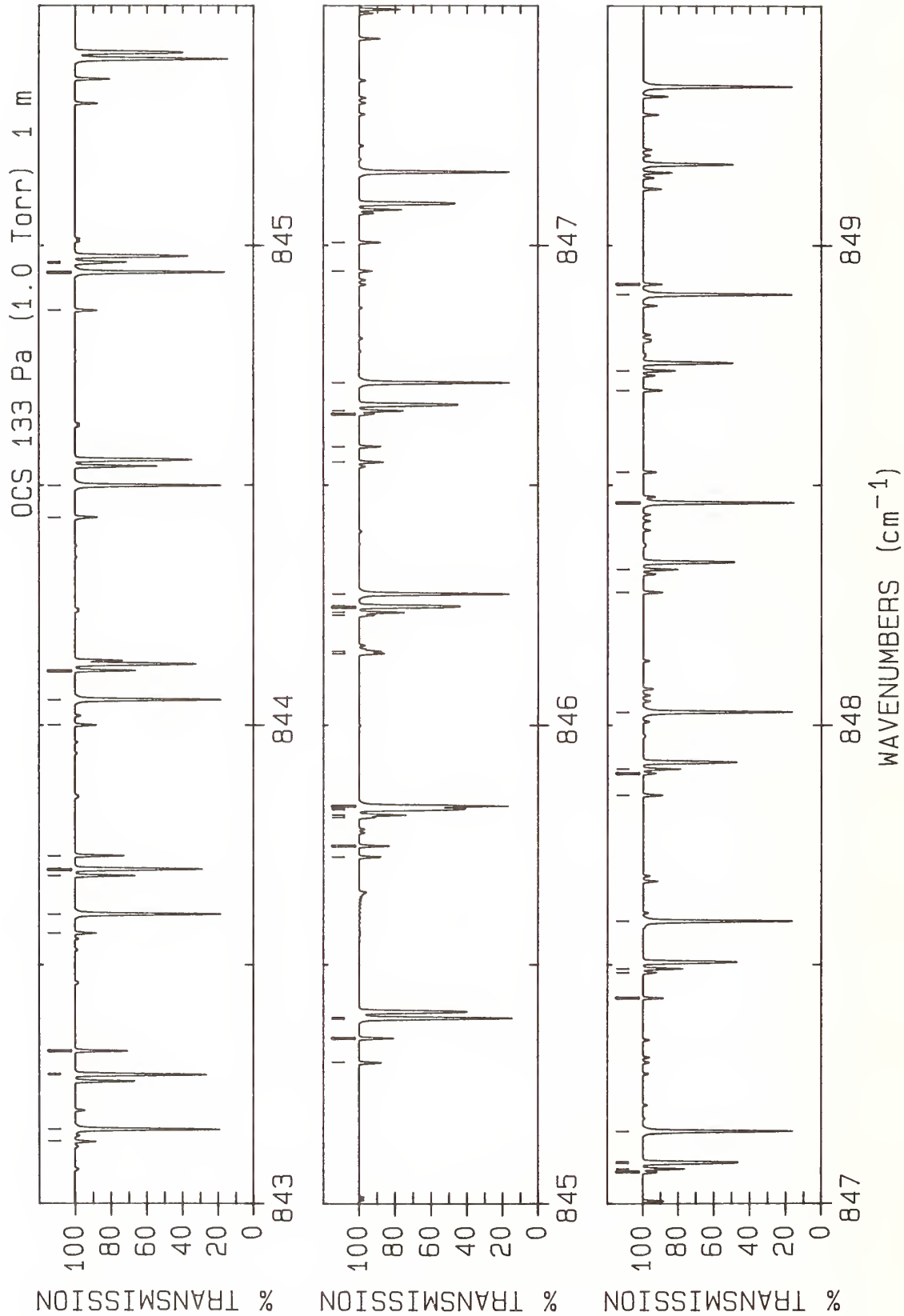

LINE #	WAVENUMBER(unc) (cm ⁻¹)	LOWER STATE (cm ⁻¹)	INTENSITY (cm/molecule)	ASSIGNMENT ROTATION BAND	LINE #	WAVENUMBER(unc) (cm ⁻¹)	LOWER STATE (cm ⁻¹)	INTENSITY (cm/molecule)	ASSIGNMENT ROTATION BAND
1	843.131 06(7)	152.84	0.154E-21	P(27) T	36	846.148 94(12)*	3.96	0.185E-21	P(4) P
2	843.156 95(5)*	285.13	0.101E-19	P(37) A	37	846.153 45(8)	84.92	0.159E-21	P(20) T
3	843.270 56(7)*	614.35	0.115E-20	P(21) C	38	846.228 78(12)	61.29	0.107E-21	P(17) L
4	843.272 65(7)*	614.25	0.115E-20	P(21) B	39	846.234 52(7)*	901.44	0.382E-21	P(14) D
5	843.320 77(11)*	26.12	0.456E-21	P(11) P	40	846.245 65(7)*	563.12	0.988E-21	P(14) C
6	843.566 37(7)	141.93	0.157E-21	P(26) T	41	846.248 63(7)*	563.07	0.988E-21	P(14) B
7	843.605 70(5)*	270.13	0.106E-19	P(36) A	42	846.273 24(5)*	188.62	0.131E-19	P(30) A
8	843.686 25(7)*	943.90	0.442E-21	P(20) D	43	846.548 27(12)*	2.38	0.140E-21	P(3) P
9	843.686 46(12)	110.55	0.114E-21	P(23) L	44	846.580 49(8)	76.83	0.158E-21	P(19) T
10	843.698 80(7)*	605.81	0.115E-20	P(20) C	45	846.648 38(12)	54.48	0.104E-21	P(16) L
11	843.701 11(7)*	605.72	0.115E-20	P(20) B	46	846.654 96(7)*	895.77	0.365E-21	P(13) D
12	843.728 31(12)*	21.77	0.424E-21	P(10) P	47	846.713 68(5)*	176.45	0.135E-19	P(29) A
13	844.000 51(7)	131.41	0.158E-21	P(25) T	48	846.946 42(12)*	1.19	0.940E-22	P(2) P
14	844.053 26(5)*	255.53	0.110E-19	P(35) A	49	847.006 34(8)	69.15	0.155E-21	P(18) T
15	844.113 12(12)	101.34	0.114E-21	P(22) L	50	847.066 79(12)	48.07	0.101E-21	P(15) L
16	844.114 01(7)*	935.82	0.437E-21	P(19) D	51	847.074 18(7)*	890.52	0.346E-21	P(12) D
17	844.433 46(8)	121.31	0.160E-21	P(24) T	52	847.085 99(7)*	552.14	0.893E-21	P(12) C
18	844.499 63(5)*	241.34	0.115E-19	P(34) A	53	847.088 93(7)*	552.11	0.893E-21	P(12) B
19	844.865 23(8)	111.60	0.161E-21	P(23) T	54	847.152 93(5)*	164.69	0.138E-19	P(28) A
20	844.943 90(12)*	11.08	0.313E-21	P(7) P	55	847.431 01(8)	61.87	0.152E-21	P(17) T
21	844.944 81(5)*	227.55	0.119E-19	P(33) A	56	847.484 02(12)	42.06	0.973E-22	P(14) L
22	844.962 92(12)	84.12	0.113E-21	P(20) L	57	847.492 19(7)*	885.66	0.324E-21	P(11) D
23	844.965 87(7)*	920.85	0.421E-21	P(17) D	58	847.590 98(5)*	153.34	0.140E-19	P(27) A
24	845.295 82(8)	102.30	0.161E-21	P(22) T	59	847.854 49(9)	55.00	0.148E-21	P(16) T
25	845.346 76(12)*	8.31	0.272E-21	P(6) P	60	847.900 07(12)	36.45	0.929E-22	P(13) L
26	845.386 05(12)	76.11	0.112E-21	P(19) L	61	847.908 96(7)*	881.21	0.301E-21	P(10) D
27	845.388 81(5)*	214.17	0.124E-19	P(32) A	62	848.027 85(5)*	142.38	0.143E-19	P(26) A
28	845.389 97(7)*	913.98	0.410E-21	P(16) D	63	848.276 79(9)	48.53	0.143E-21	P(15) T
29	845.725 23(8)	93.41	0.161E-21	P(21) T	64	848.324 52(7)*	877.17	0.277E-21	P(9) D
30	845.748 44(12)*	5.94	0.229E-21	P(5) P	65	848.463 53(5)*	131.84	0.145E-19	P(25) A
31	845.808 01(12)	68.50	0.110E-21	P(18) L	66	848.527 24(12)*	0.40	0.945E-22	P(1) P
32	845.812 85(7)*	907.50	0.397E-21	P(15) D	67	848.697 90(9)	42.46	0.138E-21	P(14) T
33	845.823 87(7)*	569.22	0.103E-20	P(15) C	68	848.738 85(7)*	873.53	0.251E-21	P(8) D
34	845.826 81(7)*	569.16	0.103E-20	P(15) B	69	848.898 02(5)*	121.70	0.146E-19	P(24) A
35	845.831 62(5)*	201.19	0.128E-19	P(31) A	70	848.919 50(12)*	1.19	0.141E-21	P(2) P

OCS 133 Pa (1.0 Torr) 1 m

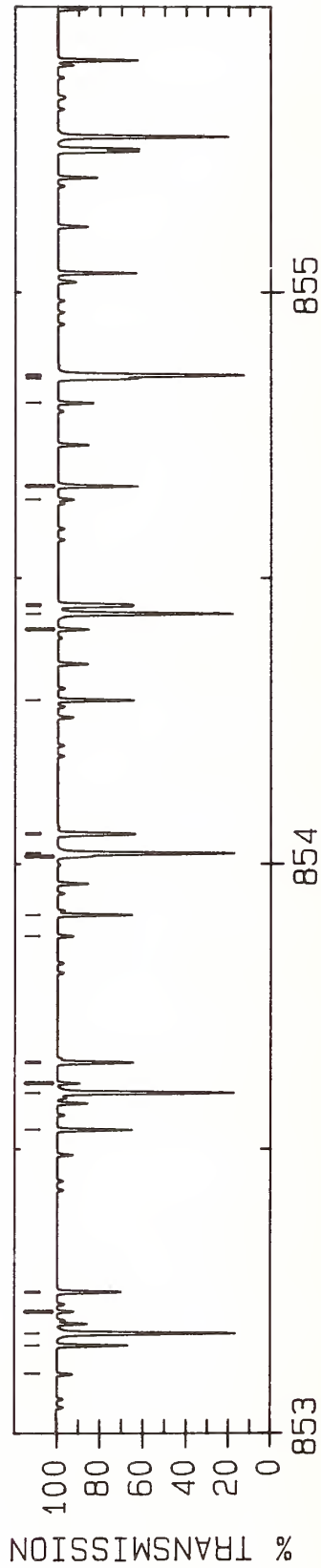
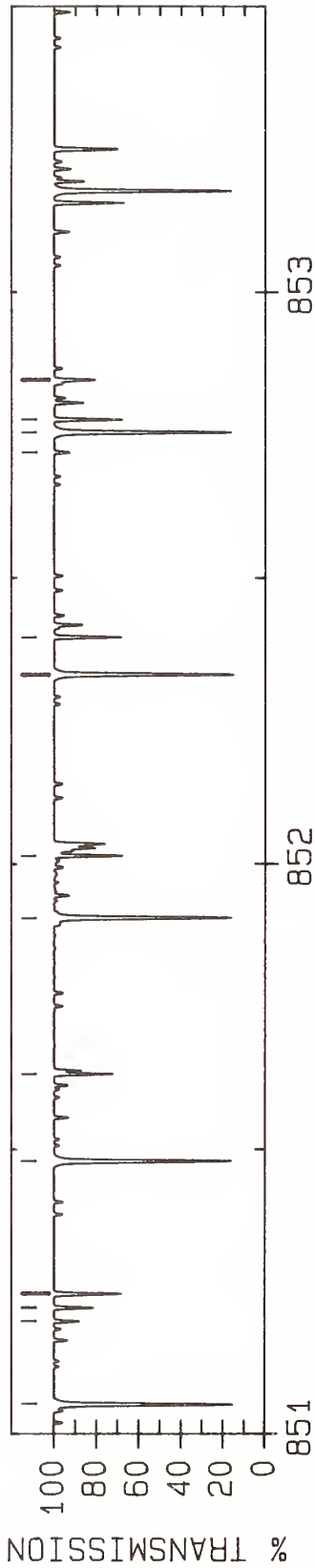
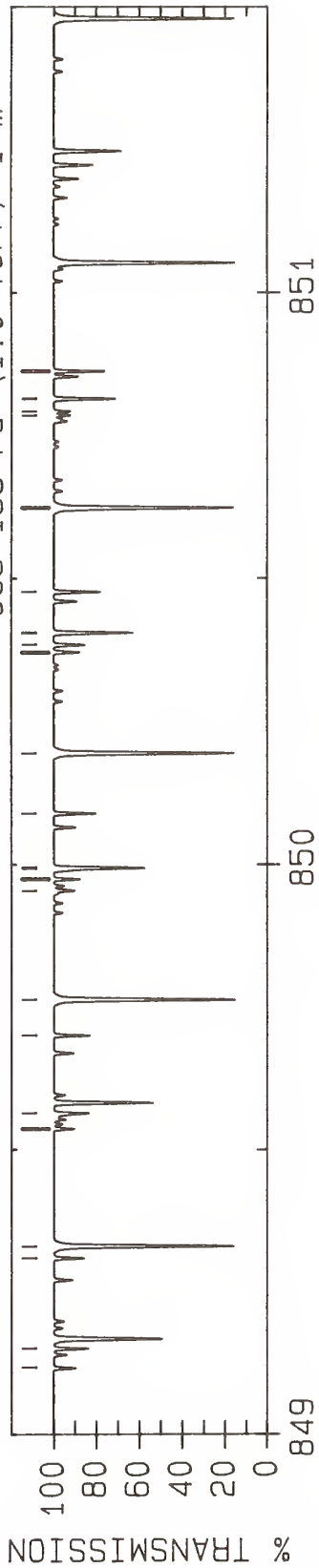

WAVENUMBERS (cm^{-1})

LINE #	WAVENUMBER(unc) (cm ⁻¹)	LOWER STATE (cm ⁻¹)	INTENSITY (cm/molecule)	ASSIGNMENT ROTATION BAND	LINE #	WAVENUMBER(unc) (cm ⁻¹)	LOWER STATE (cm ⁻¹)	INTENSITY (cm/molecule)	ASSIGNMENT ROTATION BAND
1	849.117 82(9)	36.80	0.131E-21	P(13) T	36	852.396 43(11)*	26.12	0.503E-21	R(11) P
2	849.151 96(7)*	870.29	0.223E-21	P(7) D	37	852.719 57(10)	1116.63	0.924E-22	R(18) G
3	849.310 57(12)*	2.38	0.187E-21	R(3) P	38	852.754 74(5)*	48.68	0.131E-19	P(15) A
4	849.331 31(5)*	111.96	0.147E-19	P(23) A	39	852.776 81(11)*	30.87	0.533E-21	R(12) P
5	849.536 56(9)	31.54	0.125E-21	P(12) T	40	852.846 23(7)*	520.83	0.132E-21	R(1) B
6	849.563 84(7)*	867.46	0.194E-21	P(6) D	41	852.847 18(7)*	520.83	0.132E-21	R(1) C
7	849.700 46(12)*	3.96	0.233E-21	R(4) P	42	853.105 30(10)	1124.36	0.937E-22	R(19) G
8	849.763 42(5)*	102.63	0.147E-19	P(22) A	43	853.155 99(11)*	36.02	0.560E-21	R(13) P
9	849.954 10(9)	26.69	0.117E-21	P(11) T	44	853.177 30(5)*	42.60	0.126E-19	P(14) A
10	849.974 49(7)*	865.03	0.164E-21	P(5) D	45	853.215 42(7)*	860.18	0.101E-21	R(2) D
11	849.993 16(7)*	526.52	0.409E-21	P(5) C	46	853.249 07(7)*	521.64	0.234E-21	R(2) B
12	849.994 95(7)*	526.51	0.409E-21	P(5) B	47	853.250 54(7)*	521.64	0.234E-21	R(2) C
13	850.089 16(12)*	5.94	0.277E-21	R(5) P	48	853.533 98(11)*	41.56	0.584E-21	R(14) P
14	850.194 33(5)*	93.71	0.146E-19	P(21) A	49	853.598 65(5)*	36.92	0.120E-19	P(13) A
15	850.370 46(9)	22.24	0.109E-21	P(10) T	50	853.614 99(7)*	861.39	0.134E-21	R(3) D
16	850.383 91(7)*	863.01	0.132E-21	P(4) D	51	853.650 79(7)*	522.86	0.327E-21	R(3) B
17	850.404 13(7)*	524.49	0.323E-21	P(4) C	52	853.652 81(7)*	522.86	0.327E-21	R(3) C
18	850.405 63(7)*	524.48	0.323E-21	P(4) B	53	853.873 55(10)	1141.04	0.951E-22	R(21) G
19	850.476 68(12)*	8.31	0.319E-21	R(6) P	54	853.910 77(10)*	47.49	0.606E-21	R(15) P
20	850.624 05(5)*	85.19	0.145E-19	P(20) A	55	854.013 32(7)*	863.01	0.166E-21	R(4) D
21	850.785 62(9)	18.20	0.998E-22	P(9) T	56	854.018 81(5)*	31.64	0.114E-19	P(12) A
22	850.792 11(7)*	861.39	0.100E-21	P(3) D	57	854.051 37(7)*	524.48	0.415E-21	R(4) B
23	850.814 03(7)*	522.86	0.231E-21	P(3) C	58	854.053 98(7)*	524.49	0.415E-21	R(4) C
24	850.815 20(7)*	522.86	0.231E-21	P(3) B	59	854.286 36(10)*	53.83	0.624E-21	R(16) P
25	850.863 01(12)*	11.08	0.360E-21	R(7) P	60	854.410 40(7)*	865.03	0.197E-21	R(5) D
26	851.052 58(5)*	77.08	0.144E-19	P(19) A	61	854.437 76(5)*	26.78	0.107E-19	P(11) A
27	851.199 59(10)	14.56	0.903E-22	P(8) T	62	854.450 83(7)*	526.51	0.500E-21	R(5) B
28	851.222 83(7)*	521.64	0.131E-21	P(2) C	63	854.454 06(7)*	526.52	0.500E-21	R(5) C
29	851.223 65(7)*	521.64	0.131E-21	P(2) B	64	854.637 52(10)	1159.35	0.950E-22	R(23) G
30	851.248 15(12)*	14.25	0.399E-21	R(8) P	65	854.660 75(10)*	60.55	0.640E-21	R(17) P
31	851.479 91(5)*	69.37	0.142E-19	P(18) A	66	854.806 25(7)*	867.46	0.228E-21	R(6) D
32	851.632 10(11)*	17.81	0.436E-21	R(9) P	67	854.849 16(7)*	528.95	0.581E-21	R(6) B
33	851.906 05(5)*	62.07	0.138E-19	P(17) A	68	854.853 05(7)*	528.96	0.581E-21	R(6) C
34	852.014 86(11)*	21.77	0.471E-21	R(10) P	69	854.855 52(5)*	22.31	0.992E-20	P(10) A
35	852.331 00(5)*	55.17	0.135E-19	P(16) A					

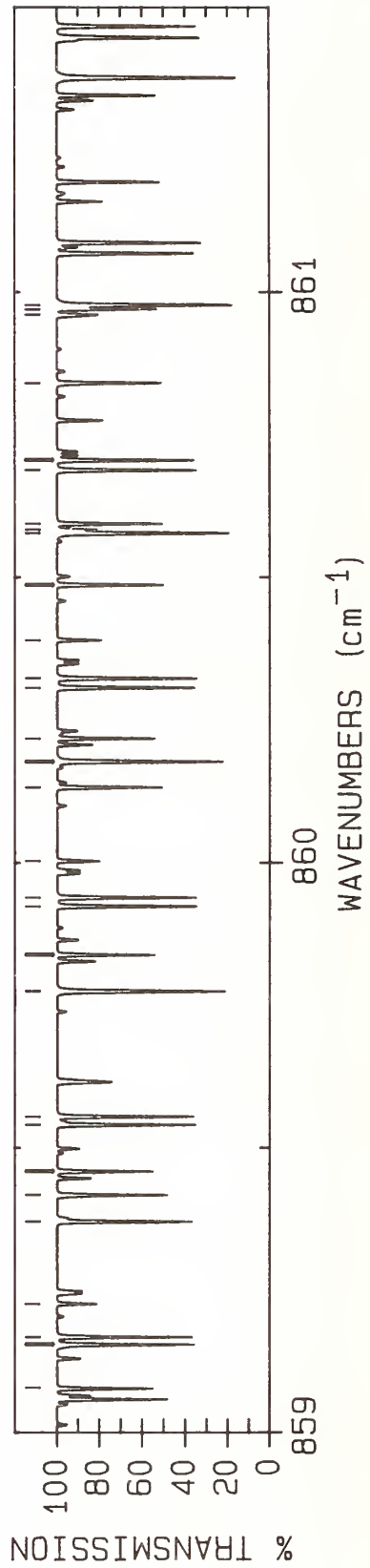
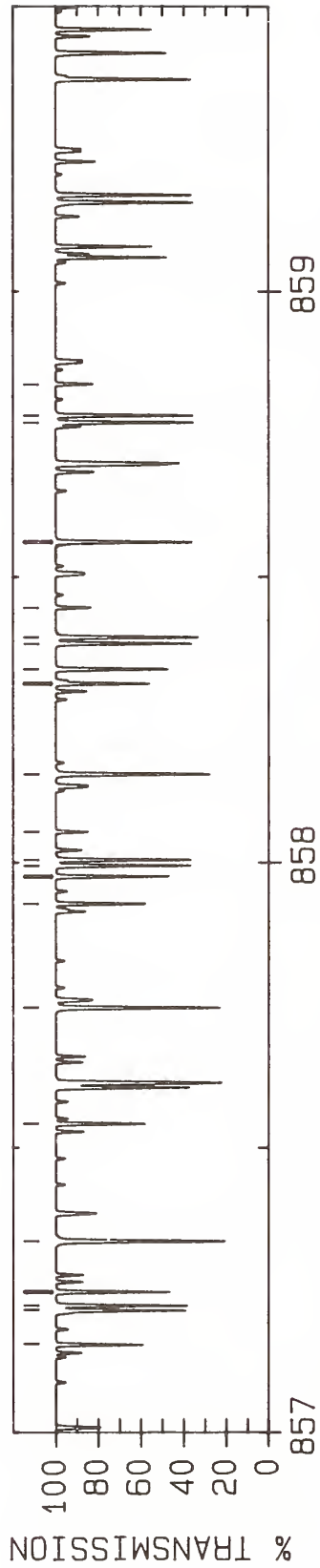
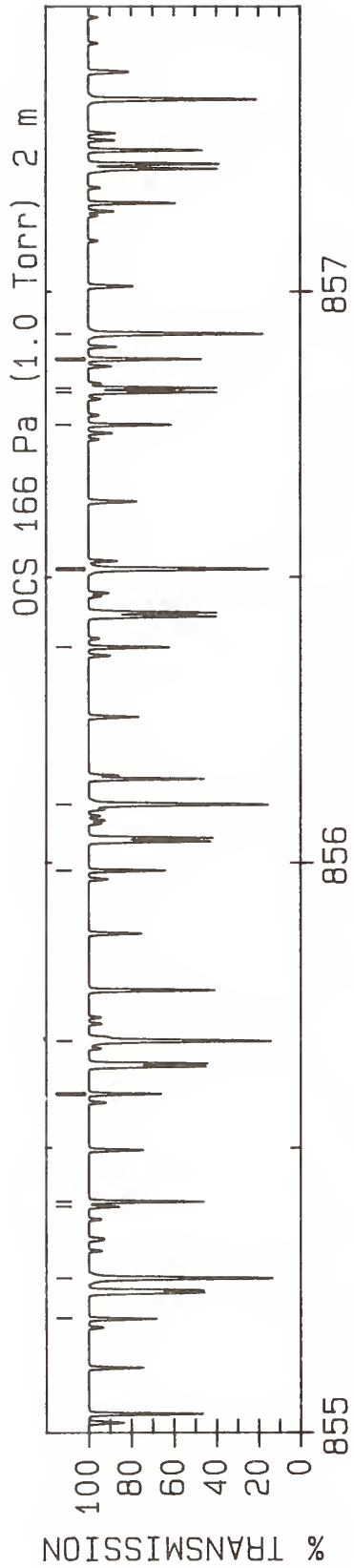

LINE #	WAVENUMBER(unc) (cm ⁻¹)	LOWER STATE (cm ⁻¹)	INTENSITY (cm/molecule)	ASSIGNMENT ROTATION BAND	LINE #	WAVENUMBER(unc) (cm ⁻¹)	LOWER STATE (cm ⁻¹)	INTENSITY (cm/molecule)	ASSIGNMENT ROTATION BAND
1	855.200 86(7)*	870.29	0.257E-21	R(7) D	36	858.770 09(7)*	575.66	0.115E-20	R(16) B
2	855.272 08(5)*	18.26	0.911E-20	P(9) A	37	858.782 27(7)*	575.72	0.115E-20	R(16) C
3	855.397 21(10)	1179.29	0.935E-22	R(25) G	38	858.837 41(9)	22.24	0.121E-21	R(10) T
4	855.405 93(9)*	75.19	0.663E-21	R(19) P	39	859.078 39(7)*	920.85	0.454E-21	R(17) D
5	855.594 23(7)*	873.53	0.284E-21	R(8) D	40	859.155 91(7)*	582.57	0.118E-20	R(17) B
6	855.687 44(5)*	14.61	0.825E-20	P(8) A	41	859.169 10(7)*	582.63	0.118E-20	R(17) C
7	855.986 35(7)*	877.17	0.311E-21	R(9) D	42	859.227 34(9)	26.69	0.129E-21	R(11) T
8	856.101 59(5)*	11.36	0.734E-20	P(7) A	43	859.371 44(5)*	0.00	0.111E-20	R(0) A
9	856.377 23(7)*	881.21	0.335E-21	R(10) D	44	859.418 06(7)*	184.01	0.608E-21	R(30) P
10	856.514 54(5)*	8.52	0.638E-20	P(6) A	45	859.459 26(7)*	928.13	0.463E-21	R(18) D
11	856.514 67(9)*	100.13	0.676E-21	R(22) P	46	859.540 59(7)*	589.88	0.120E-20	R(18) B
12	856.766 86(7)*	885.66	0.358E-21	R(11) D	47	859.554 82(7)*	589.95	0.120E-20	R(18) C
13	856.823 84(7)*	547.23	0.926E-21	R(11) B	48	859.774 73(5)*	0.41	0.222E-20	R(1) A
14	856.831 47(7)*	547.26	0.926E-21	R(11) C	49	859.775 50(7)*	196.27	0.592E-21	R(31) P
15	856.881 84(9)*	109.23	0.675E-21	R(23) P	50	859.838 87(7)*	935.82	0.469E-21	R(19) D
16	856.926 29(5)*	6.09	0.538E-20	P(5) A	51	859.924 12(7)*	597.60	0.122E-20	R(19) B
17	857.155 24(7)*	890.52	0.379E-21	R(12) D	52	859.939 42(7)*	597.68	0.122E-20	R(19) C
18	857.215 37(7)*	552.11	0.981E-21	R(12) B	53	860.003 56(9)	36.80	0.143E-21	R(13) T
19	857.223 84(7)*	552.14	0.981E-21	R(12) C	54	860.131 73(6)*	208.93	0.574E-21	R(32) P
20	857.247 80(8)*	118.72	0.672E-21	R(24) P	55	860.176 81(5)*	1.22	0.332E-20	R(2) A
21	857.336 83(5)*	4.06	0.435E-20	P(4) A	56	860.217 22(7)*	943.90	0.474E-21	R(20) D
22	857.542 37(7)*	895.77	0.398E-21	R(13) D	57	860.306 50(7)*	605.72	0.123E-20	R(20) B
23	857.746 17(5)*	2.43	0.329E-20	P(3) A	58	860.322 90(7)*	605.81	0.123E-20	R(20) C
24	857.928 26(7)*	901.44	0.415E-21	R(14) D	59	860.389 85(9)	42.46	0.150E-21	R(14) T
25	857.976 08(8)*	138.90	0.659E-21	R(26) P	60	860.486 74(6)*	221.99	0.556E-21	R(33) P
26	857.995 01(7)*	563.07	0.107E-20	R(14) B	61	860.577 68(5)*	2.43	0.440E-20	R(3) A
27	858.005 28(7)*	563.12	0.107E-20	R(14) C	62	860.583 99(12)	68.50	0.118E-21	R(18) L
28	858.053 91(9)	14.56	0.102E-21	R(8) T	63	860.594 31(7)*	952.40	0.477E-21	R(21) D
29	858.154 30(5)*	1.22	0.221E-20	P(2) A	64	860.687 73(7)*	614.25	0.124E-20	R(21) B
30	858.312 89(7)*	907.50	0.430E-21	R(15) D	65	860.705 27(7)*	614.35	0.124E-20	R(21) C
31	858.338 40(8)*	149.59	0.649E-21	R(27) P	66	860.840 51(6)*	235.44	0.536E-21	R(34) P
32	858.383 12(7)*	569.16	0.112E-20	R(15) B	67	860.960 48(12)	76.11	0.120E-21	R(19) L
33	858.394 33(7)*	569.22	0.112E-20	R(15) C	68	860.970 14(7)*	961.29	0.478E-21	R(22) D
34	858.446 27(9)	18.20	0.112E-21	R(9) T	69	860.977 33(5)*	4.06	0.546E-20	R(4) A
35	858.561 22(5)*	0.41	0.111E-20	P(1) A					

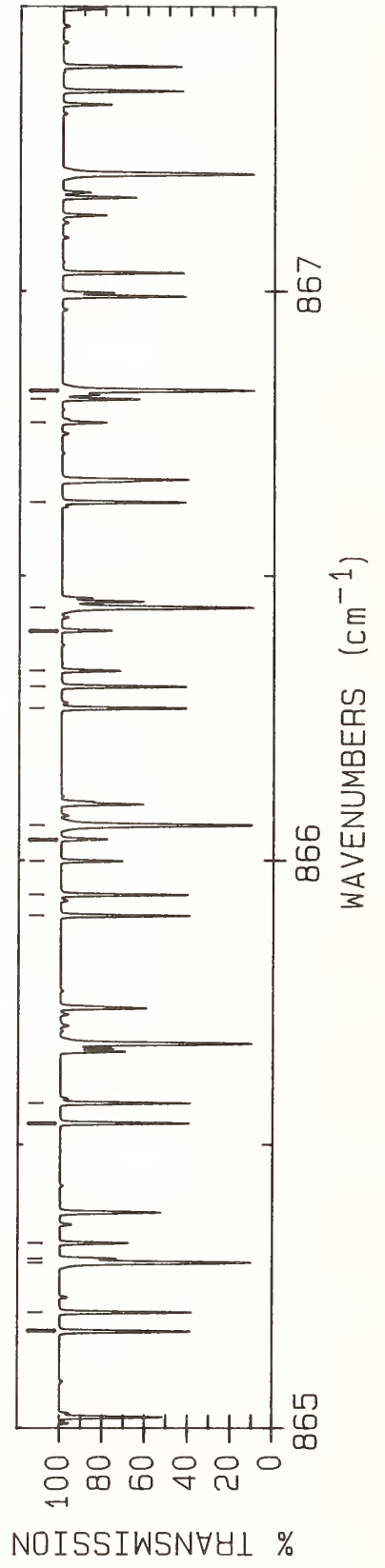
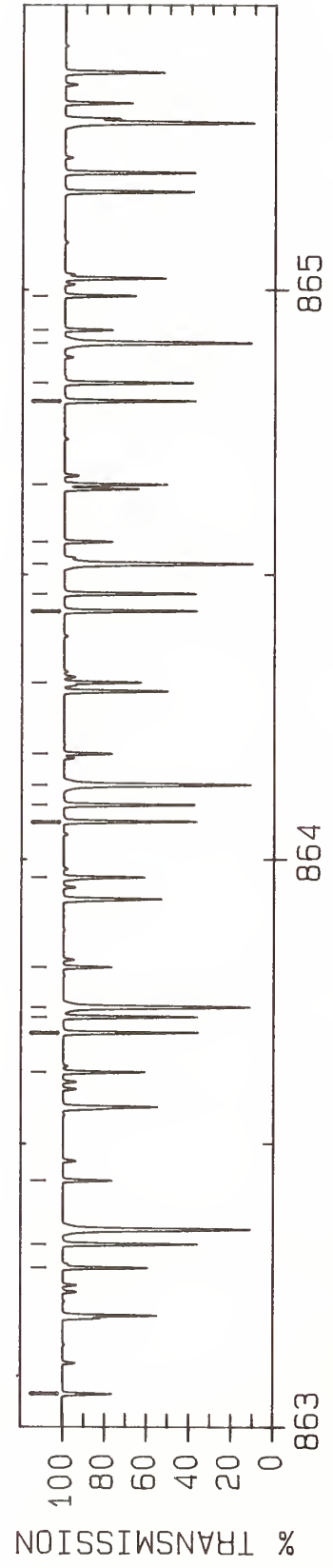
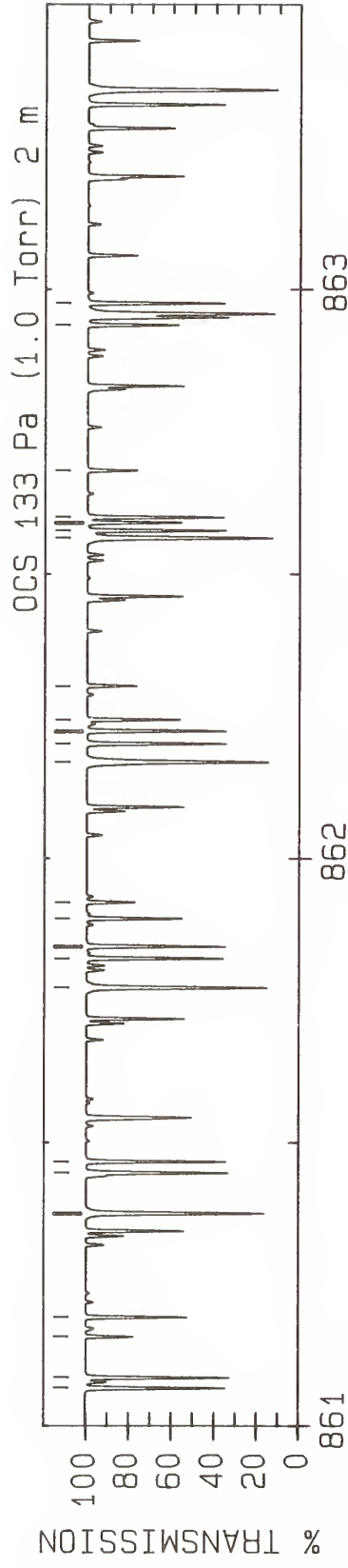

LINE #	WAVENUMBER(unc) (cm ⁻¹)	LOWER STATE (cm ⁻¹)	INTENSITY (cm/molecule)	ASSIGNMENT ROTATION BAND	LINE #	WAVENUMBER(unc) (cm ⁻¹)	LOWER STATE (cm ⁻¹)	INTENSITY (cm/molecule)	ASSIGNMENT ROTATION BAND
1	861.067 81(7)*	623.18	0.124E-20	R(22) B	36	864.095 85(7)*	709.47	0.110E-20	R(30) C
2	861.086 51(7)*	623.29	0.124E-20	R(22) C	37	864.130 70(5)*	31.64	0.125E-19	R(12) A
3	861.158 76(8)	55.00	0.160E-21	R(16) T	38	864.185 43(7)	121.31	0.171E-21	R(24) T
4	861.193 07(6)*	249.29	0.516E-21	R(35) P	39	864.310 54(5)*	391.68	0.324E-21	R(44) P
5	861.375 77(5)*	6.09	0.649E-20	R(5) A	40	864.436 35(7)*	721.86	0.107E-20	R(31) B
6	861.446 73(7)*	632.52	0.124E-20	R(23) B	41	864.466 91(7)*	722.07	0.107E-20	R(31) C
7	861.466 63(7)*	632.64	0.124E-20	R(23) C	42	864.519 37(5)*	36.92	0.131E-19	R(13) A
8	861.772 99(5)*	8.52	0.749E-20	R(6) A	43	864.558 23(7)	131.41	0.169E-21	R(25) T
9	861.824 50(7)*	642.27	0.123E-20	R(24) B	44	864.658 62(7)*	1072.49	0.401E-21	R(32) D
10	861.845 62(7)*	642.40	0.123E-20	R(24) C	45	864.804 81(7)*	734.85	0.104E-20	R(32) B
11	861.894 48(5)*	278.16	0.473E-21	R(37) P	46	864.836 84(7)*	735.07	0.104E-20	R(32) C
12	861.922 79(8)	69.15	0.167E-21	R(18) T	47	864.906 82(5)*	42.60	0.136E-19	R(14) A
13	862.168 99(5)*	11.36	0.845E-20	R(7) A	48	864.929 79(7)	141.93	0.167E-21	R(26) T
14	862.201 11(7)*	652.42	0.122E-20	R(25) B	49	864.989 68(5)*	427.66	0.284E-21	R(46) P
15	862.223 49(7)*	652.56	0.122E-20	R(25) C	50	865.172 09(7)*	748.25	0.100E-20	R(33) B
16	862.243 34(5)*	293.19	0.452E-21	R(38) P	51	865.205 62(7)*	748.49	0.100E-20	R(33) C
17	862.302 97(8)	76.83	0.169E-21	R(19) T	52	865.293 03(5)*	48.68	0.141E-19	R(15) A
18	862.563 78(5)*	14.61	0.936E-20	R(8) A	53	865.300 12(7)	152.84	0.164E-21	R(27) T
19	862.576 56(7)*	662.98	0.120E-20	R(26) B	54	865.327 37(5)*	446.25	0.265E-21	R(47) P
20	862.590 97(5)*	308.62	0.430E-21	R(39) P	55	865.538 19(7)*	762.05	0.966E-21	R(34) B
21	862.600 22(7)*	663.13	0.120E-20	R(26) C	56	865.573 25(7)*	762.31	0.965E-21	R(34) C
22	862.681 92(8)	84.92	0.171E-21	R(20) T	57	865.903 13(7)*	776.26	0.928E-21	R(35) B
23	862.937 36(5)*	324.44	0.408E-21	R(40) P	58	865.939 74(7)*	776.53	0.927E-21	R(35) C
24	862.975 83(7)*	674.10	0.118E-20	R(27) C	59	865.999 01(6)*	484.60	0.229E-21	R(49) P
25	863.059 64(8)	93.41	0.172E-21	R(21) T	60	866.037 05(7)	175.88	0.158E-21	R(29) T
26	863.282 52(5)*	340.66	0.387E-21	R(41) P	61	866.061 78(5)*	62.07	0.149E-19	R(17) A
27	863.323 97(7)*	685.31	0.116E-20	R(28) B	62	866.266 88(7)*	790.88	0.889E-21	R(36) B
28	863.436 14(8)	102.30	0.172E-21	R(22) T	63	866.305 07(7)*	791.16	0.888E-21	R(36) C
29	863.626 44(5)*	357.27	0.365E-21	R(42) P	64	866.332 94(6)*	504.37	0.213E-21	R(50) P
30	863.695 93(7)*	697.09	0.113E-20	R(29) B	65	866.403 65(7)	188.01	0.154E-21	R(30) T
31	863.723 65(7)*	697.27	0.113E-20	R(29) C	66	866.444 30(5)*	69.37	0.152E-19	R(18) A
32	863.740 81(5)*	26.78	0.118E-19	R(11) A	67	866.629 45(7)*	805.90	0.849E-21	R(37) B
33	863.811 40(7)	111.60	0.172E-21	R(23) T	68	866.769 01(7)	200.54	0.149E-21	R(31) T
34	863.969 11(5)*	374.27	0.344E-21	R(43) P	69	866.810 31(7)*	1158.61	0.313E-21	R(38) D
35	864.066 73(7)*	709.27	0.110E-20	R(30) B	70	866.825 59(5)*	77.08	0.154E-19	R(19) A

OCS 133 Pa (1.0 Torr) 2 m

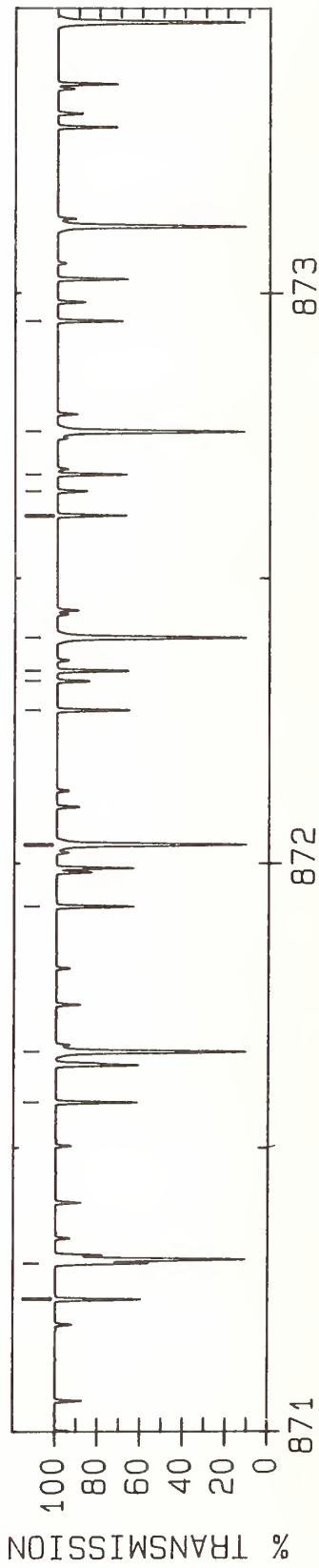
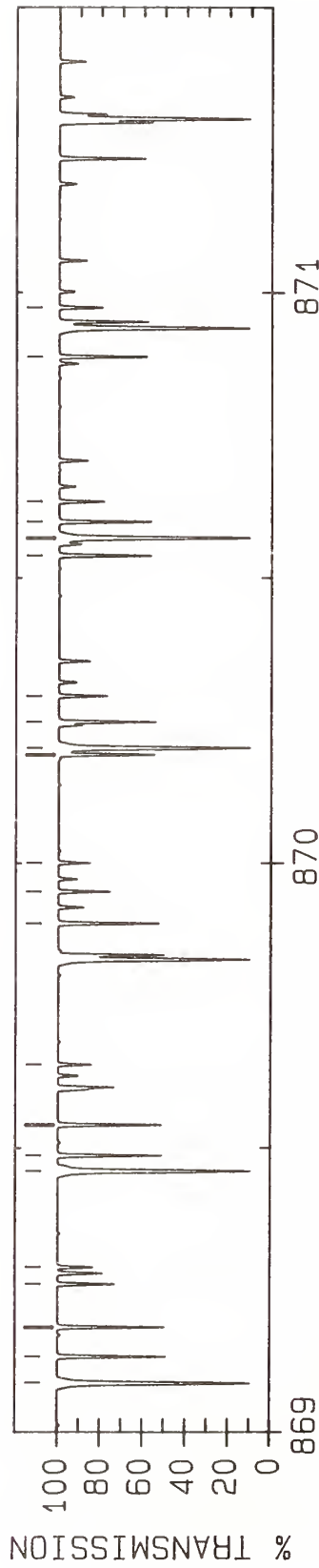
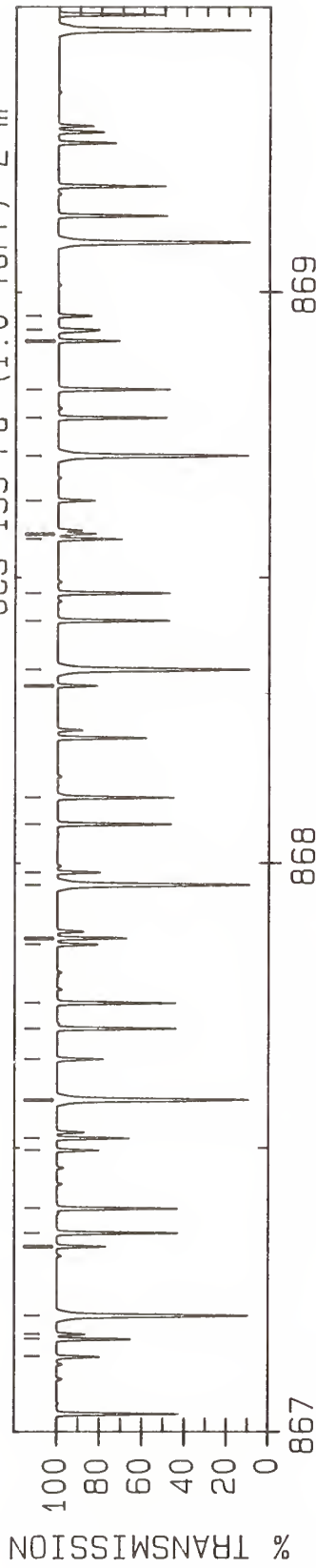

LINE #	WAVENUMBER(cm ⁻¹)	LOWER STATE (cm ⁻¹)	INTENSITY (cm/molecule)	ASSIGNMENT ROTATION BAND	LINE #	WAVENUMBER(unc) (cm ⁻¹)	LOWER STATE (cm ⁻¹)	INTENSITY (cm/molecule)	ASSIGNMENT ROTATION BAND
1	867.133 12(7)	213.48	0.145E-21	R(32) T	36	869.261 75(7)*	1277.44	0.208E-21	R(45) D
2	867.164 41(7)*	1174.37	0.297E-21	R(39) D	37	869.291 51(8)	299.57	0.113E-21	R(38) T
3	867.173 07(12)	266.73	0.884E-22	R(36) L	38	869.459 94(5)*	142.38	0.152E-19	R(26) A
4	867.205 64(5)*	85.19	0.156E-19	R(20) A	39	869.487 22(7)*	940.66	0.536E-21	R(45) B
5	867.327 22(6)*	566.04	0.167E-21	R(53) P	40	869.540 96(7)*	941.10	0.535E-21	R(45) C
6	867.351 03(7)*	837.16	0.769E-21	R(39) B	41	869.646 85(8)	315.33	0.107E-21	R(39) T
7	867.394 16(7)*	837.49	0.767E-21	R(39) C	42	869.894 67(7)*	959.78	0.499E-21	R(46) C
8	867.495 98(7)	226.82	0.140E-21	R(33) T	43	869.950 42(7)*	1315.02	0.181E-21	R(47) D
9	867.517 21(7)*	1190.54	0.282E-21	R(40) D	44	870.000 92(8)	331.50	0.102E-21	R(40) T
10	867.584 46(5)*	93.71	0.157E-19	R(21) A	45	870.189 70(7)*	978.40	0.466E-21	R(47) B
11	867.656 12(6)*	587.39	0.154E-21	R(54) P	46	870.201 42(5)*	164.69	0.147E-19	R(28) A
12	867.710 05(7)*	853.39	0.728E-21	R(40) B	47	870.247 20(7)*	978.88	0.465E-21	R(47) C
13	867.754 87(7)*	853.74	0.727E-21	R(40) C	48	870.292 80(7)*	1334.42	0.168E-21	R(48) D
14	867.857 60(7)	240.56	0.134E-21	R(34) T	49	870.539 13(7)*	997.88	0.433E-21	R(48) B
15	867.868 72(7)*	1207.11	0.266E-21	R(41) D	50	870.570 28(5)*	176.45	0.143E-19	R(29) A
16	867.962 04(5)*	102.63	0.157E-19	R(22) A	51	870.598 54(7)*	998.38	0.432E-21	R(48) C
17	867.983 76(7)*	609.13	0.141E-21	R(55) P	52	870.633 86(7)*	1354.22	0.156E-21	R(49) D
18	868.067 87(7)*	870.04	0.688E-21	R(41) B	53	870.887 35(7)*	1017.76	0.401E-21	R(49) B
19	868.114 42(7)*	870.40	0.687E-21	R(41) C	54	870.973 60(7)*	1374.42	0.144E-21	R(50) D
20	868.310 13(7)*	631.27	0.129E-21	R(56) P	55	871.234 36(7)*	1038.05	0.371E-21	R(50) B
21	868.338 38(5)*	111.96	0.157E-19	R(23) A	56	871.297 69(8)*	1038.59	0.370E-21	R(50) C
22	868.424 50(7)*	887.08	0.649E-21	R(42) B	57	871.580 16(7)*	1058.74	0.342E-21	R(51) B
23	868.472 81(7)*	887.47	0.648E-21	R(42) C	58	871.669 36(5)*	214.17	0.132E-19	R(32) A
24	868.567 84(7)*	1241.47	0.236E-21	R(43) D	59	871.924 74(7)*	1079.84	0.315E-21	R(52) B
25	868.577 07(7)	269.26	0.124E-21	R(36) T	60	872.033 22(5)*	227.55	0.127E-19	R(33) A
26	868.635 24(7)*	653.80	0.117E-21	R(57) P	61	872.268 10(7)*	1101.34	0.289E-21	R(53) B
27	868.713 47(5)*	121.70	0.156E-19	R(24) A	62	872.319 36(7)*	1459.26	0.103E-21	R(54) D
28	868.779 94(7)*	904.54	0.610E-21	R(43) B	63	872.337 49(8)*	1101.95	0.288E-21	R(53) C
29	868.830 03(7)*	904.94	0.609E-21	R(43) C	64	872.395 81(5)*	241.34	0.122E-19	R(34) A
30	868.915 45(7)*	1259.25	0.222E-21	R(44) D	65	872.610 25(7)*	1123.25	0.265E-21	R(54) B
31	868.934 92(8)	284.21	0.118E-21	R(37) T	66	872.652 49(7)*	1481.48	0.941E-22	R(55) D
32	868.959 07(7)*	676.72	0.107E-21	R(58) P	67	872.681 70(8)*	1123.88	0.264E-21	R(54) C
33	869.087 33(5)*	131.84	0.154E-19	R(25) A	68	872.757 14(5)*	255.53	0.118E-19	R(35) A
34	869.134 18(7)*	922.39	0.573E-21	R(44) B	69	872.951 16(7)*	1145.56	0.242E-21	R(55) B
35	869.186 08(7)*	922.82	0.571E-21	R(44) C					

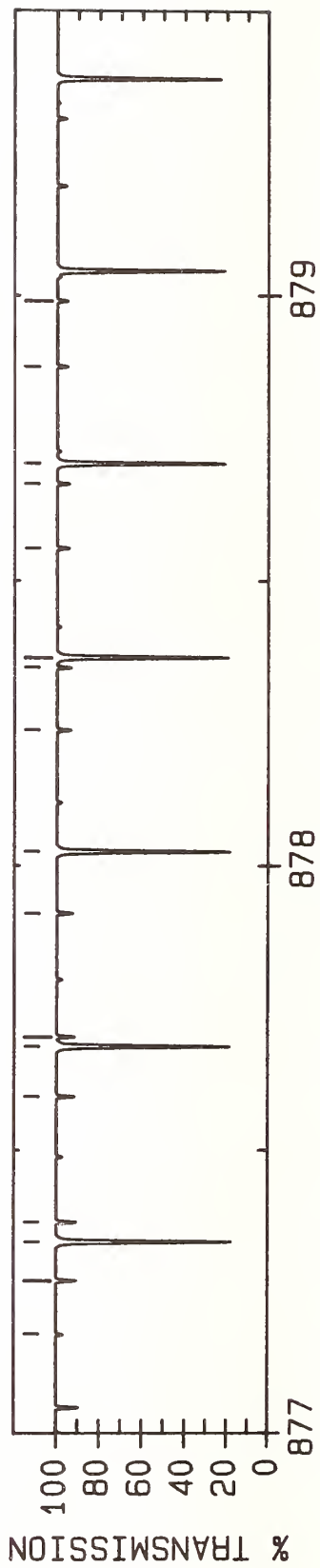
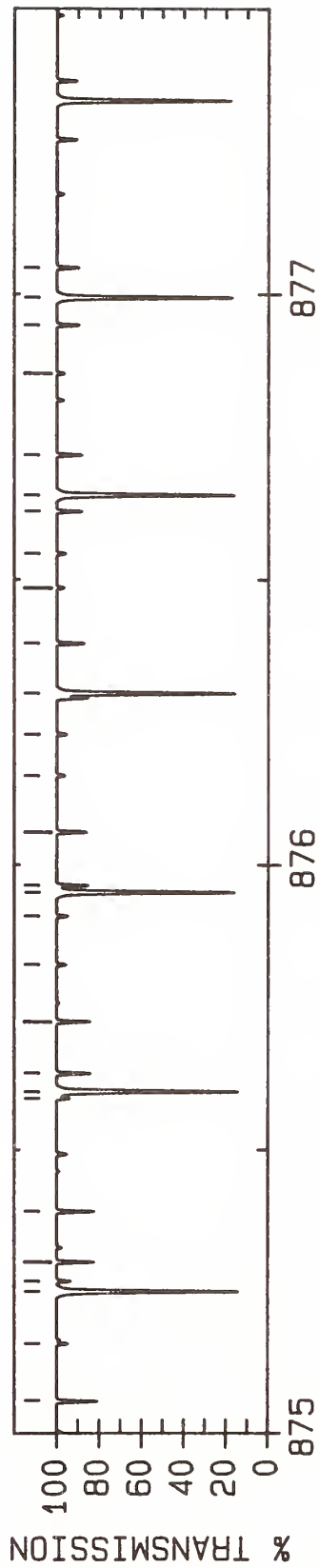
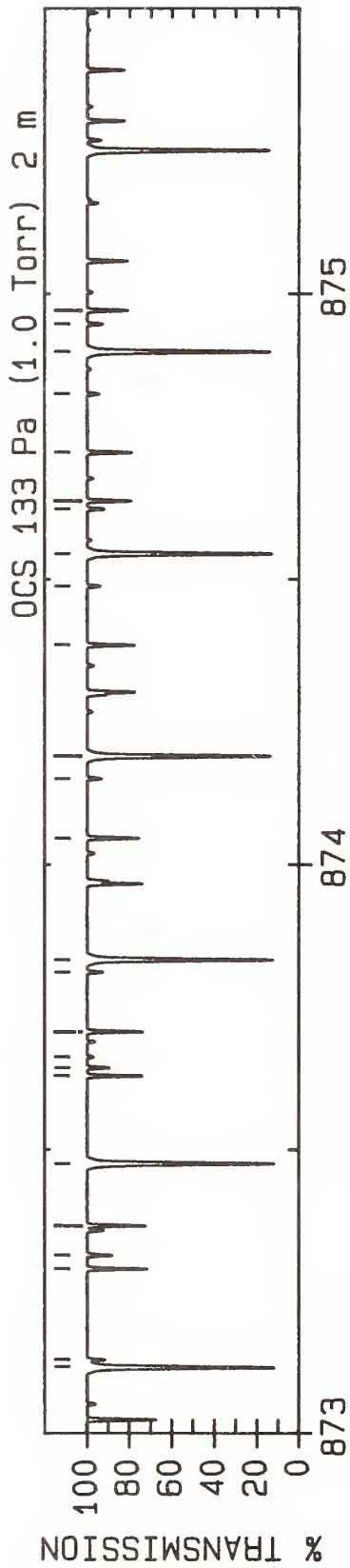

LINE #	WAVENUMBER(unc) (cm ⁻¹)	LOWER STATE (cm ⁻¹)	INTENSITY (cm/molecule)	ASSIGNMENT ROTATION BAND	LINE #	WAVENUMBER(unc) (cm ⁻¹)	LOWER STATE (cm ⁻¹)	INTENSITY (cm/molecule)	ASSIGNMENT ROTATION BAND
1	873.117 21(5)*	270.13	0.113E-19	R(36) A	36	875.825 07(11)	668.01	0.282E-22	R(57) T
2	873.130 46(9)	495.14	0.561E-22	R(49) T	37	875.910 23(7)*	1725.81	0.340E-22	R(65) D
3	873.290 86(7)*	1168.28	0.221E-21	R(56) B	38	875.952 11(5)*	401.49	0.725E-20	R(44) A
4	873.314 75(7)*	1527.13	0.781E-22	R(57) D	39	875.963 94(7)*	1364.57	0.972E-22	R(64) B
5	873.366 53(9)*	1168.96	0.220E-21	R(56) C	40	876.057 38(13)*	1365.45	0.968E-22	R(64) C
6	873.476 01(5)*	285.13	0.108E-19	R(37) A	41	876.156 07(11)	691.43	0.256E-22	R(58) T
7	873.629 32(7)*	1191.40	0.201E-21	R(57) B	42	876.228 59(7)*	1752.46	0.303E-22	R(66) D
8	873.643 88(7)*	1550.55	0.710E-22	R(58) D	43	876.300 73(5)*	419.73	0.679E-20	R(45) A
9	873.662 75(9)*	1067.84	0.201E-22	R(73) P	44	876.388 24(14)*	1391.83	0.865E-22	R(65) C
10	873.707 13(9)*	1192.10	0.200E-21	R(57) C	45	876.485 75(12)	715.26	0.232E-22	R(59) T
11	873.811 86(9)	535.94	0.479E-22	R(51) T	46	876.545 60(7)*	1779.51	0.270E-22	R(67) D
12	873.833 55(5)*	300.54	0.102E-19	R(38) A	47	876.619 77(8)*	1417.69	0.775E-22	R(66) B
13	874.046 53(10)*	1215.65	0.182E-21	R(58) C	48	876.648 08(5)*	438.37	0.634E-20	R(46) A
14	874.150 63(9)	556.95	0.441E-22	R(52) T	49	876.717 86(14)*	1418.62	0.772E-22	R(66) C
15	874.189 83(5)*	316.35	0.973E-20	R(39) A	50	876.861 25(7)*	1806.96	0.240E-22	R(68) D
16	874.384 72(10)*	1239.61	0.164E-21	R(59) C	51	876.945 79(8)*	1444.85	0.690E-22	R(67) B
17	874.488 10(10)	578.35	0.405E-22	R(53) T	52	876.994 14(5)*	457.42	0.590E-20	R(47) A
18	874.544 83(5)*	332.57	0.922E-20	R(40) A	53	877.046 25(15)*	1445.81	0.686E-22	R(67) C
19	874.623 24(7)*	1623.25	0.524E-22	R(61) D	54	877.175 54(7)*	1834.81	0.212E-22	R(69) D
20	874.637 32(7)*	1263.19	0.149E-21	R(60) B	55	877.270 56(8)*	1472.41	0.612E-22	R(68) B
21	874.721 69(10)*	1263.97	0.149E-21	R(60) C	56	877.338 91(5)*	476.88	0.548E-20	R(48) A
22	874.824 29(10)	600.16	0.371E-22	R(54) T	57	877.373 40(16)*	1473.41	0.609E-22	R(68) C
23	874.898 56(5)*	349.19	0.872E-20	R(41) A	58	877.594 07(9)*	1500.39	0.542E-22	R(69) B
24	874.947 01(7)*	1648.29	0.472E-22	R(62) D	59	877.682 40(5)*	496.74	0.508E-20	R(49) A
25	874.970 84(7)*	1287.93	0.135E-21	R(61) B	60	877.699 30(17)*	1501.41	0.540E-22	R(69) C
26	875.057 45(11)*	1288.73	0.134E-21	R(61) C	61	877.916 31(9)*	1528.76	0.479E-22	R(70) B
27	875.159 18(10)	622.38	0.339E-22	R(55) T	62	878.024 60(5)*	517.00	0.470E-20	R(50) A
28	875.251 02(5)*	366.22	0.822E-20	R(42) A	63	878.237 29(9)*	1557.54	0.423E-22	R(71) B
29	875.269 43(7)*	1673.73	0.424E-22	R(63) D	64	878.347 37(19)*	1558.62	0.421E-22	R(71) C
30	875.303 12(7)*	1313.07	0.121E-21	R(62) B	65	878.365 51(5)*	537.67	0.434E-20	R(51) A
31	875.391 98(12)*	1313.90	0.121E-21	R(62) C	66	878.556 99(10)*	1586.72	0.372E-22	R(72) B
32	875.590 51(7)*	1699.57	0.380E-22	R(64) D	67	878.669 53(21)*	1587.83	0.370E-22	R(72) C
33	875.602 20(5)*	383.65	0.773E-20	R(43) A	68	878.705 12(5)*	558.74	0.399E-20	R(52) A
34	875.634 16(7)*	1338.62	0.109E-21	R(63) B	69	878.875 42(10)*	1616.30	0.327E-22	R(73) B
35	875.725 29(12)*	1339.47	0.108E-21	R(63) C	70	878.990 43(22)*	1617.44	0.325E-22	R(73) C

OCS 133 Pa (1.0 Torr) 2 m

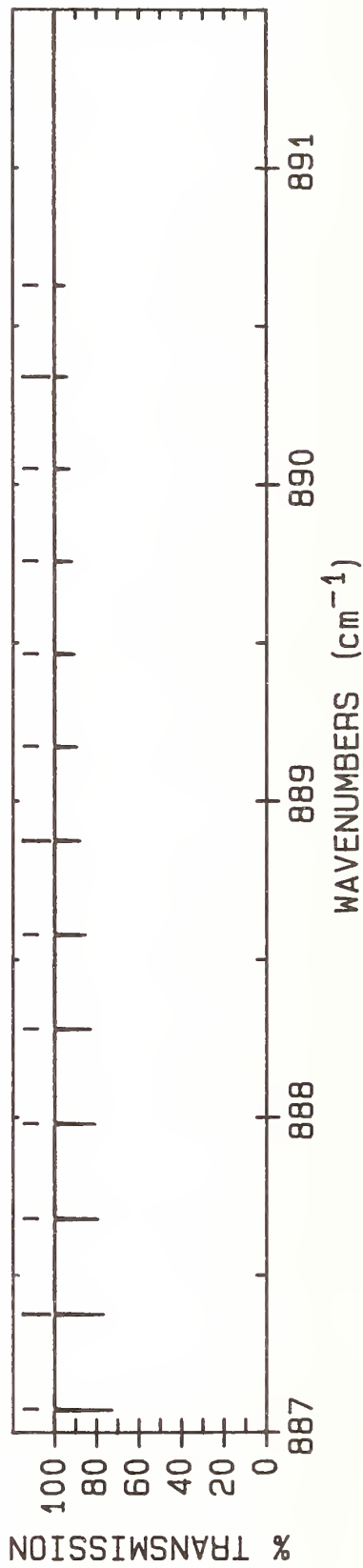
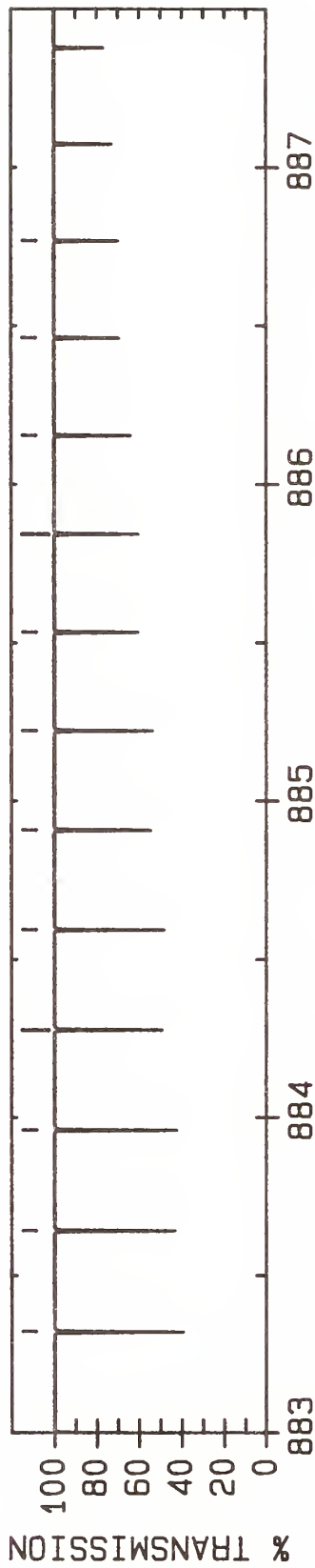
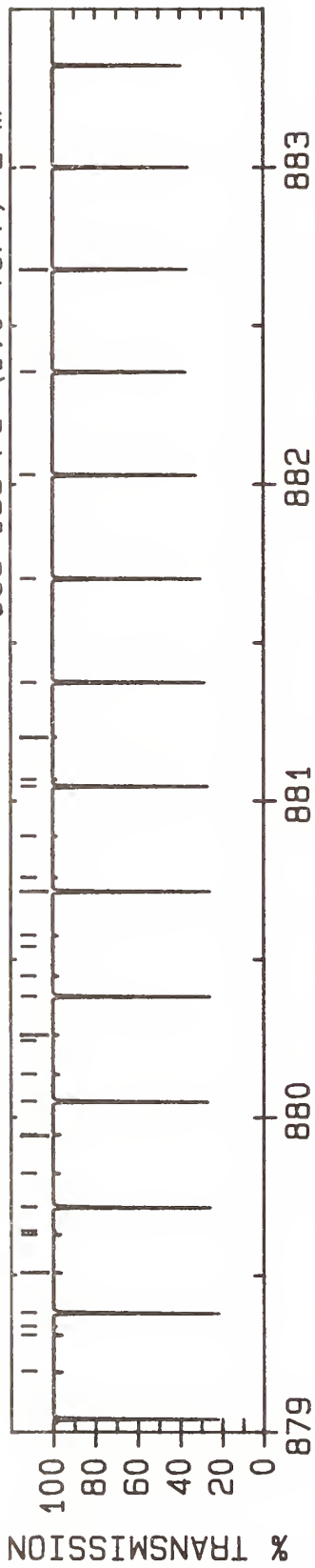

LINE #	WAVENUMBER(unc) (cm ⁻¹)	LOWER STATE (cm ⁻¹)	INTENSITY (cm/molecule)	ASSIGNMENT ROTATION BAND	LINE #	WAVENUMBER(unc) (cm ⁻¹)	LOWER STATE (cm ⁻¹)	INTENSITY (cm/molecule)	ASSIGNMENT ROTATION BAND
1	879.192 57(11)*	1646.29	0.286E-22	R(74) B	31	883.001 34(5)*	869.46	0.110E-20	R(65) A
2	879.310 07(23)*	1647.46	0.285E-22	R(74) C	32	883.322 60(5)*	896.18	0.984E-21	R(66) A
3	879.337 21(7)*	2041.03	0.860E-23	R(76) D	33	883.642 54(5)*	923.31	0.876E-21	R(67) A
4	879.380 46(5)*	602.10	0.336E-20	R(54) A	34	883.961 14(5)*	950.85	0.778E-21	R(68) A
5	879.508 44(11)*	1676.68	0.251E-22	R(75) B	35	884.278 41(5)*	978.78	0.689E-21	R(69) A
6	879.628 45(25)*	1677.89	0.249E-22	R(75) C	36	884.594 35(5)*	1007.13	0.609E-21	R(70) A
7	879.640 50(7)*	2072.09	0.749E-23	R(77) D	37	884.908 95(5)*	1035.87	0.537E-21	R(71) A
8	879.716 18(5)*	624.39	0.307E-20	R(55) A	38	885.222 21(5)*	1065.02	0.473E-21	R(72) A
9	879.823 03(12)*	1707.48	0.219E-22	R(76) B	39	885.534 12(5)*	1094.57	0.416E-21	R(73) A
10	879.942 41(7)*	2103.56	0.651E-23	R(78) D	40	885.844 69(5)*	1124.52	0.364E-21	R(74) A
11	879.945 57(26)*	1708.71	0.217E-22	R(76) C	41	886.153 91(5)*	1154.87	0.318E-21	R(75) A
12	880.050 59(5)*	647.08	0.280E-20	R(56) A	42	886.461 78(5)*	1185.63	0.278E-21	R(76) A
13	880.136 34(12)*	1738.67	0.190E-22	R(77) B	43	886.768 30(5)*	1216.79	0.242E-21	R(77) A
14	880.242 94(7)*	2135.43	0.565E-23	R(79) D	44	887.073 46(5)*	1248.35	0.210E-21	R(78) A
15	880.261 41(28)*	1739.94	0.189E-22	R(77) C	45	887.377 26(6)*	1280.32	0.183E-21	R(79) A
16	880.383 70(5)*	670.17	0.255E-20	R(57) A	46	887.679 71(6)*	1312.69	0.158E-21	R(80) A
17	880.448 35(13)*	1770.28	0.165E-22	R(78) B	47	887.980 79(6)*	1345.46	0.136E-21	R(81) A
18	880.542 07(8)*	2167.70	0.489E-23	R(80) D	48	888.280 50(6)*	1378.63	0.118E-21	R(82) A
19	880.575 98(29)*	1771.58	0.164E-22	R(78) C	49	888.578 85(7)*	1412.21	0.101E-21	R(83) A
20	880.715 51(5)*	693.67	0.231E-20	R(58) A	50	888.875 82(7)*	1446.18	0.867E-22	R(84) A
21	880.759 07(14)*	1802.28	0.143E-22	R(79) B	51	889.171 42(8)*	1480.56	0.743E-22	R(85) A
22	880.889 27(31)*	1803.61	0.142E-22	R(79) C	52	889.465 64(8)*	1515.34	0.635E-22	R(86) A
23	881.046 00(5)*	717.57	0.209E-20	R(59) A	53	889.758 48(9)*	1550.53	0.541E-22	R(87) A
24	881.068 50(14)*	1834.68	0.124E-22	R(80) B	54	890.049 94(10)*	1586.11	0.461E-22	R(88) A
25	881.201 29(33)*	1836.05	0.123E-22	R(80) C	55	890.340 02(10)*	1622.10	0.391E-22	R(89) A
26	881.375 18(5)*	741.87	0.189E-20	R(60) A	56	890.628 71(11)*	1658.48	0.332E-22	R(90) A
27	881.703 05(5)*	766.58	0.171E-20	R(61) A					
28	882.029 60(5)*	791.70	0.153E-20	R(62) A					
29	882.354 84(5)*	817.21	0.138E-20	R(63) A					
30	882.678 75(5)*	843.13	0.123E-20	R(64) A					



ATLAS OF OCS ABSORPTION LINES FROM 1000 cm^{-1} to 1095 cm^{-1}

key:

Band	Isotopomer	Vibrational Transition
A	$^{16}\text{O}^{12}\text{C}^{32}\text{S}$	02 ⁰ 0-00 ⁰ 0
X		02 ^{2e} 0-00 ⁰ 0
B		03 ¹ 0-01 ^{1e} 0
C		03 ¹ 0-01 ^{1f} 0
D		02 ⁰ 1-00 ⁰ 1
E		04 ² 0-02 ^{2e} 0
F		04 ² 0-02 ^{2f} 0
G		04 ⁰ 0-02 ⁰ 0
H		03 ¹ 1-01 ^{1e} 1
I		03 ¹ 1-01 ^{1f} 1
J		05 ³ 0-03 ^{3e} 0
K		05 ³ 0-03 ^{3f} 0
L		05 ¹ 0-03 ^{1e} 0
M		05 ¹ 0-03 ^{1f} 0
P	$^{16}\text{O}^{12}\text{C}^{34}\text{S}$	02 ⁰ 0-00 ⁰ 0
Q		03 ¹ 0-01 ^{1e} 0
R		03 ¹ 0-01 ^{1f} 0
T	$^{16}\text{O}^{13}\text{C}^{32}\text{S}$	02 ⁰ 0-00 ⁰ 0

If the e or f designation is not specified (for $l \neq 0$), then the transition is to either level, depending on the selection rules and the change in the rotational quantum number, J . Spectra are given for a slitwidth of 0.002 cm^{-1} and a temperature of 296 K. For the A, X, D, P, and T bands a transition moment of 0.0333 debye was used and no Herman-Wallis constant was included in the intensity calculation. For the other bands a transition moment of 0.032 debye was used with a Herman-Wallis constant of $C_1=0.0019$.

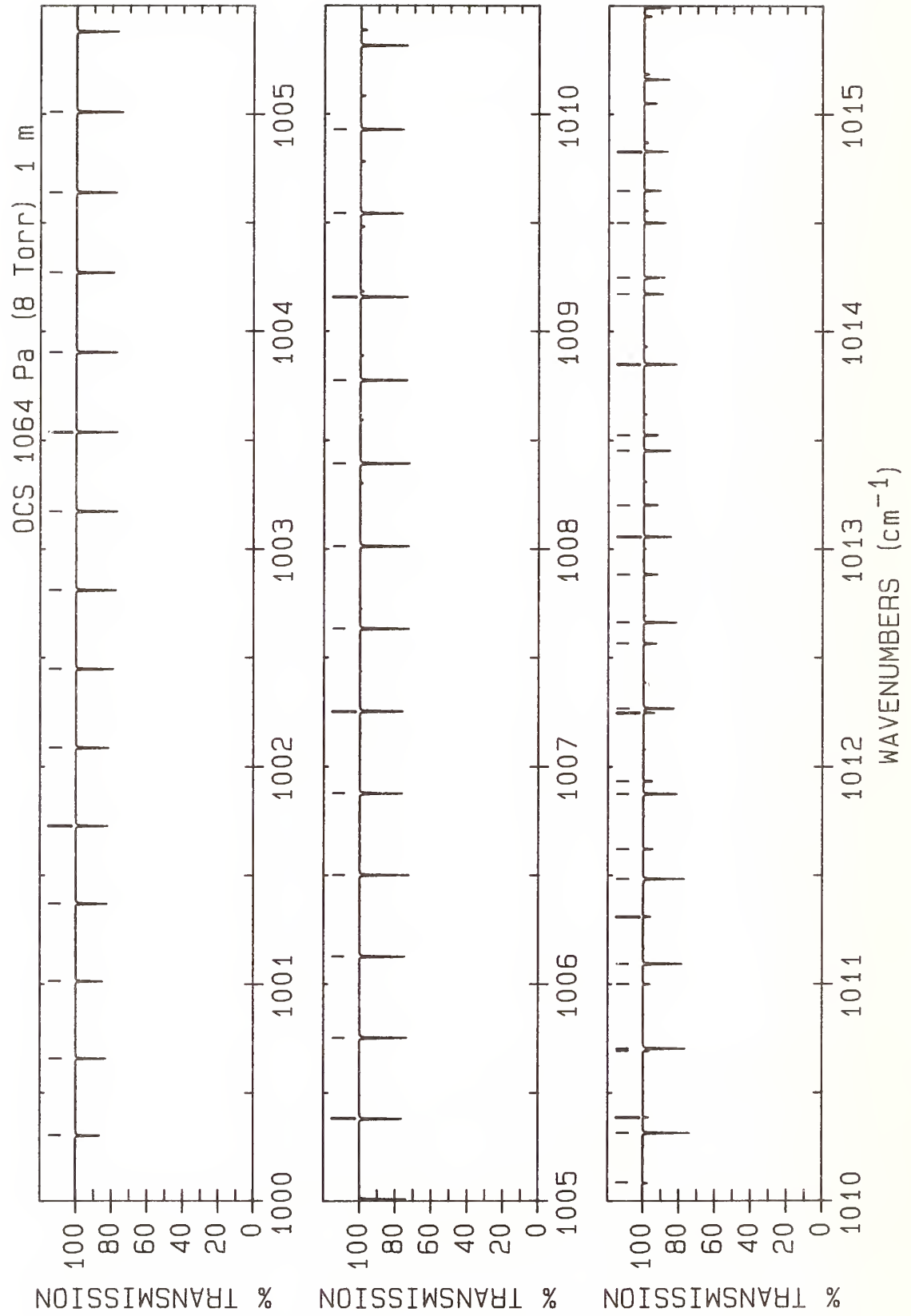

LINE #	WAVENUMBER(unc) (cm ⁻¹)	LOWER STATE (cm ⁻¹)	INTENSITY (cm/molecule)	ASSIGNMENT ROTATION BAND	LINE #	WAVENUMBER(unc) (cm ⁻¹)	LOWER STATE (cm ⁻¹)	INTENSITY (cm/molecule)	ASSIGNMENT ROTATION BAND
1	1000.304 01(6)	365.04	0.275E-22	P(42)	31	1010.693 84(10)*	1673.73	0.638E-23	P(63)
2	1000.658 14(6)	348.07	0.292E-22	P(41)	32	1010.704 25(6)	42.46	0.447E-22	P(14)
3	1001.013 61(6)	331.50	0.309E-22	P(40)	33	1011.001 19(10)*	1648.29	0.712E-23	P(62)
4	1001.370 42(6)	315.33	0.326E-22	P(39)	34	1011.093 48(6)	36.80	0.427E-22	P(13)
5	1001.728 56(6)	299.57	0.344E-22	P(38)	35	1011.310 38(10)*	1623.25	0.793E-23	P(61)
6	1002.088 01(6)	284.21	0.361E-22	P(37)	36	1011.483 90(6)	31.54	0.405E-22	P(12)
7	1002.448 78(6)	269.26	0.378E-22	P(36)	37	1011.621 42(10)*	1598.62	0.881E-23	P(60)
8	1002.810 85(5)	254.71	0.394E-22	P(35)	38	1011.875 49(6)	26.69	0.380E-22	P(11)
9	1003.174 22(5)	240.56	0.411E-22	P(34)	39	1011.934 27(10)*	1574.38	0.976E-23	P(59)
10	1003.538 88(5)	226.82	0.427E-22	P(33)	40	1012.248 94(10)*	1550.55	0.108E-22	P(58)
11	1003.904 82(5)	213.48	0.442E-22	P(32)	41	1012.268 26(6)	22.24	0.353E-22	P(10)
12	1004.272 04(5)	200.54	0.456E-22	P(31)	42	1012.565 41(10)*	1527.13	0.119E-22	P(57)
13	1004.640 52(5)	188.01	0.469E-22	P(30)	43	1012.662 20(7)	18.20	0.324E-22	P(9)
14	1005.010 27(5)	175.88	0.481E-22	P(29)	44	1012.883 66(10)*	1504.10	0.131E-22	P(56)
15	1005.381 28(5)	164.16	0.492E-22	P(28)	45	1013.057 32(7)	14.56	0.294E-22	P(8)
16	1005.753 54(5)	152.84	0.502E-22	P(27)	46	1013.203 69(10)*	1481.48	0.144E-22	P(55)
17	1006.127 04(5)	141.93	0.510E-22	P(26)	47	1013.453 60(7)	11.32	0.261E-22	P(7)
18	1006.501 78(5)	131.41	0.516E-22	P(25)	48	1013.525 49(10)*	1459.26	0.158E-22	P(54)
19	1006.877 75(5)	121.31	0.521E-22	P(24)	49	1013.849 04(10)*	1437.45	0.172E-22	P(53)
20	1007.254 95(5)	111.60	0.523E-22	P(23)	50	1013.851 05(7)	8.49	0.227E-22	P(6)
21	1007.633 38(5)	102.30	0.524E-22	P(22)	51	1014.174 33(10)*	1416.04	0.188E-22	P(52)
22	1008.013 02(5)	93.41	0.522E-22	P(21)	52	1014.249 66(7)	6.07	0.191E-22	P(5)
23	1008.393 87(5)	84.92	0.519E-22	P(20)	53	1014.501 35(9)*	1395.03	0.204E-22	P(51)
24	1008.775 94(5)	76.83	0.513E-22	P(19)	54	1014.649 44(7)	4.04	0.155E-22	P(4)
25	1009.159 21(5)	69.15	0.504E-22	P(18)	55	1014.830 09(9)*	1374.42	0.222E-22	P(50)
26	1009.543 68(5)	61.87	0.494E-22	P(17)					
27	1009.929 34(6)	55.00	0.481E-22	P(16)					
28	1010.084 72(10)*	1725.81	0.509E-23	P(65)					
29	1010.316 20(6)	48.53	0.465E-22	P(15)					
30	1010.388 34(10)*	1699.57	0.571E-23	P(64)					

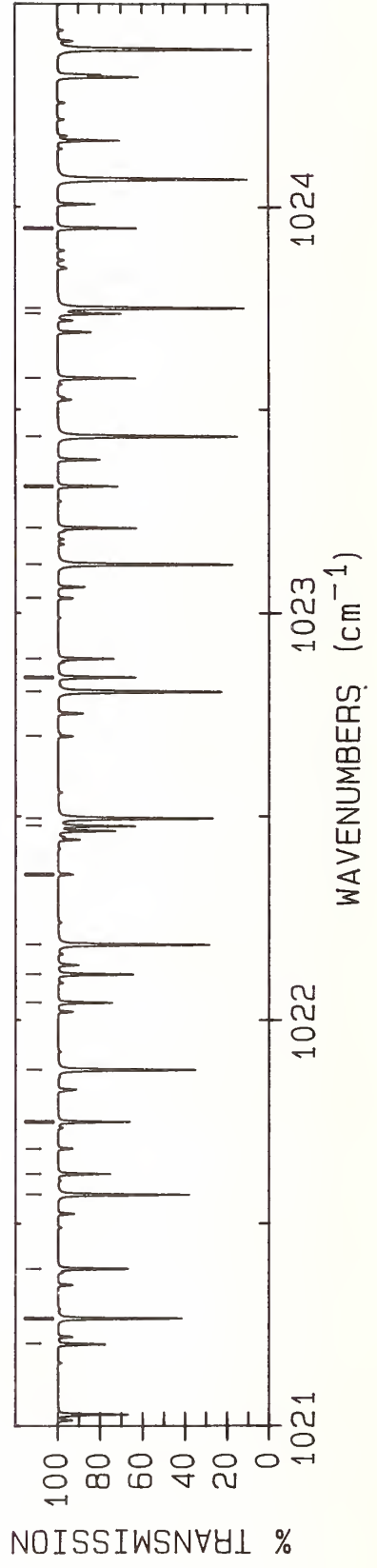
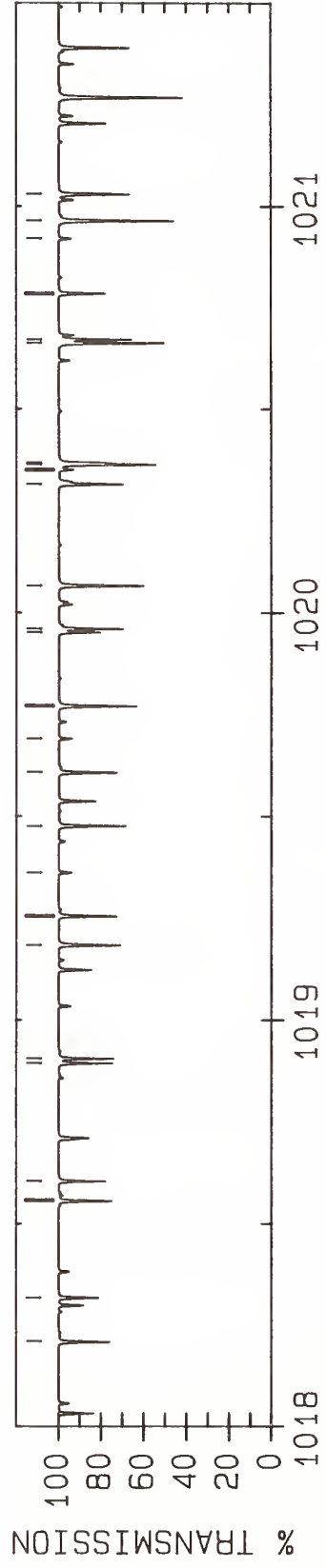
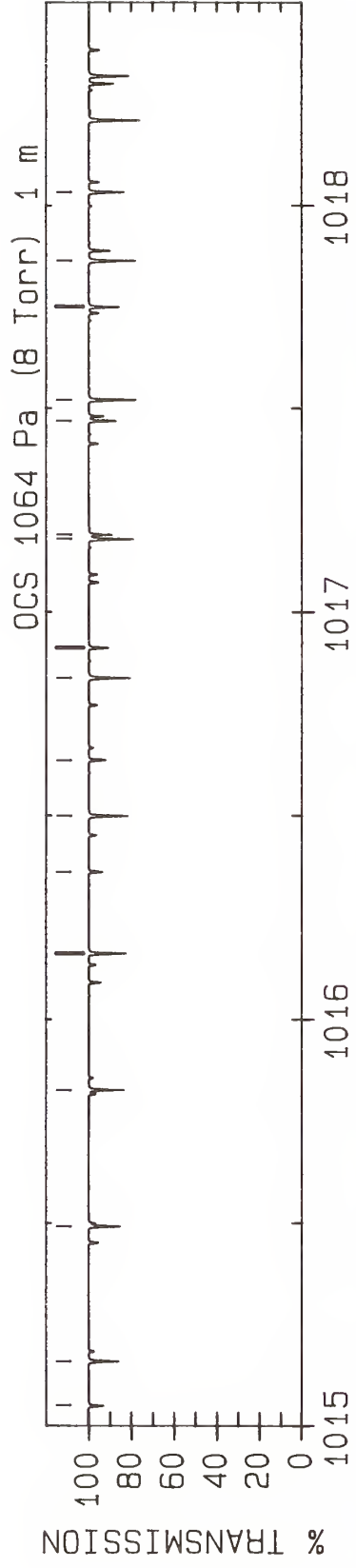

LINE #	WAVENUMBER(cm^{-1})	LOWER STATE (cm^{-1})	INTENSITY ($\text{cm}/\text{molecule}$)	ASSIGNMENT ROTATION BAND	LINE #	WAVENUMBER(cm^{-1})	LOWER STATE (cm^{-1})	INTENSITY ($\text{cm}/\text{molecule}$)	ASSIGNMENT ROTATION BAND
1	1015.050 37(7)	2.43	0.117E-22	P(3)	36	1020.363 532(38)*	1154.87	0.946E-22	P(75)
2	1015.160 54(9)*	1354.22	0.240E-22	P(49)	37	1020.367 66(6)	18.20	0.363E-22	R(9)
3	1015.492 68(9)*	1334.42	0.259E-22	P(48)	38	1020.662 834(36)*	1124.52	0.108E-21	P(74)
4	1015.826 52(9)*	1315.02	0.279E-22	P(47)	39	1020.671 55(10)*	1085.84	0.604E-22	P(33)
5	1016.162 02(9)*	1296.03	0.300E-22	P(46)	40	1020.784 75(6)	22.24	0.392E-22	R(10)
6	1016.362 28(11)*	1622.10	0.111E-22	P(89)	41	1020.919 90(30)	954.88	0.100E-22	P(69)
7	1016.499 19(9)*	1277.44	0.322E-22	P(45)	42	1020.963 888(34)*	1094.57	0.124E-21	P(73)
8	1016.636 14(10)*	1586.11	0.131E-22	P(88)	43	1021.029 49(10)*	1072.49	0.625E-22	P(32)
9	1016.838 02(9)*	1259.25	0.344E-22	P(44)	44	1021.203 00(6)	26.69	0.418E-22	R(11)
10	1016.911 857(92)*	1550.53	0.155E-22	P(87)	45	1021.266 683(32)*	1065.02	0.141E-21	P(72)
11	1017.178 49(9)*	1241.47	0.367E-22	P(43)	46	1021.388 97(10)*	1059.56	0.646E-22	P(31)
12	1017.189 440(85)*	1515.34	0.182E-22	P(86)	47	1021.571 210(30)*	1035.87	0.161E-21	P(71)
13	1017.468 878(78)*	1480.56	0.214E-22	P(85)	48	1021.622 41(6)	31.54	0.443E-22	R(12)
14	1017.520 60(9)*	1224.09	0.390E-22	P(42)	49	1021.684 32(22)	580.22	0.119E-22	P(53)
15	1017.750 163(72)*	1446.18	0.251E-22	P(84)	50	1021.749 98(10)*	1047.02	0.664E-22	P(30)
16	1017.864 33(9)*	1207.11	0.414E-22	P(41)	51	1021.877 458(29)*	1007.13	0.183E-21	P(70)
17	1018.033 288(67)*	1412.21	0.293E-22	P(83)	52	1022.042 98(6)	36.80	0.465E-22	R(13)
18	1018.209 67(9)*	1190.54	0.438E-22	P(40)	53	1022.112 52(10)*	1034.89	0.682E-22	P(29)
19	1018.318 245(62)*	1378.63	0.342E-22	P(82)	54	1022.185 417(27)*	978.78	0.207E-21	P(69)
20	1018.556 62(9)*	1174.37	0.462E-22	P(39)	55	1022.358 19(22)	537.67	0.120E-22	P(51)
21	1018.605 026(58)*	1345.46	0.398E-22	P(81)	56	1022.476 57(10)*	1023.17	0.697E-22	P(28)
22	1018.893 623(54)*	1312.69	0.462E-22	P(80)	57	1022.495 077(26)*	950.85	0.235E-21	P(68)
23	1018.905 17(10)*	1158.61	0.487E-22	P(38)	58	1022.696 88(22)	517.00	0.121E-22	P(50)
24	1019.184 027(50)*	1280.32	0.536E-22	P(79)	59	1022.806 427(25)*	923.31	0.265E-21	P(67)
25	1019.255 31(10)*	1143.24	0.511E-22	P(37)	60	1022.842 13(10)*	1011.84	0.711E-22	P(27)
26	1019.361 59(21)	741.87	0.101E-22	P(60)	61	1022.887 58(5)	48.53	0.503E-22	R(15)
27	1019.476 228(47)*	1248.35	0.619E-22	P(78)	62	1023.036 75(23)	496.74	0.120E-22	P(49)
28	1019.607 02(10)*	1128.29	0.535E-22	P(36)	63	1023.119 458(24)*	896.18	0.298E-21	P(66)
29	1019.690 09(21)	717.57	0.105E-22	P(59)	64	1023.209 19(10)*	1000.93	0.722E-22	P(26)
30	1019.770 219(44)*	1216.79	0.715E-22	P(77)	65	1023.311 63(5)	55.00	0.518E-22	R(16)
31	1019.951 71(6)	14.56	0.333E-22	R(8)	66	1023.434 158(22)*	869.46	0.335E-21	P(65)
32	1019.960 30(10)*	1113.73	0.559E-22	P(35)	67	1023.577 75(10)*	990.41	0.731E-22	P(25)
33	1020.065 990(41)*	1185.63	0.823E-22	P(76)	68	1023.736 84(5)	61.87	0.530E-22	R(17)
34	1020.315 15(10)*	1099.58	0.582E-22	P(34)	69	1023.750 518(21)*	843.13	0.376E-21	P(64)
35	1020.350 36(21)	670.17	0.111E-22	P(57)	70	1023.947 80(10)*	980.30	0.737E-22	P(24)

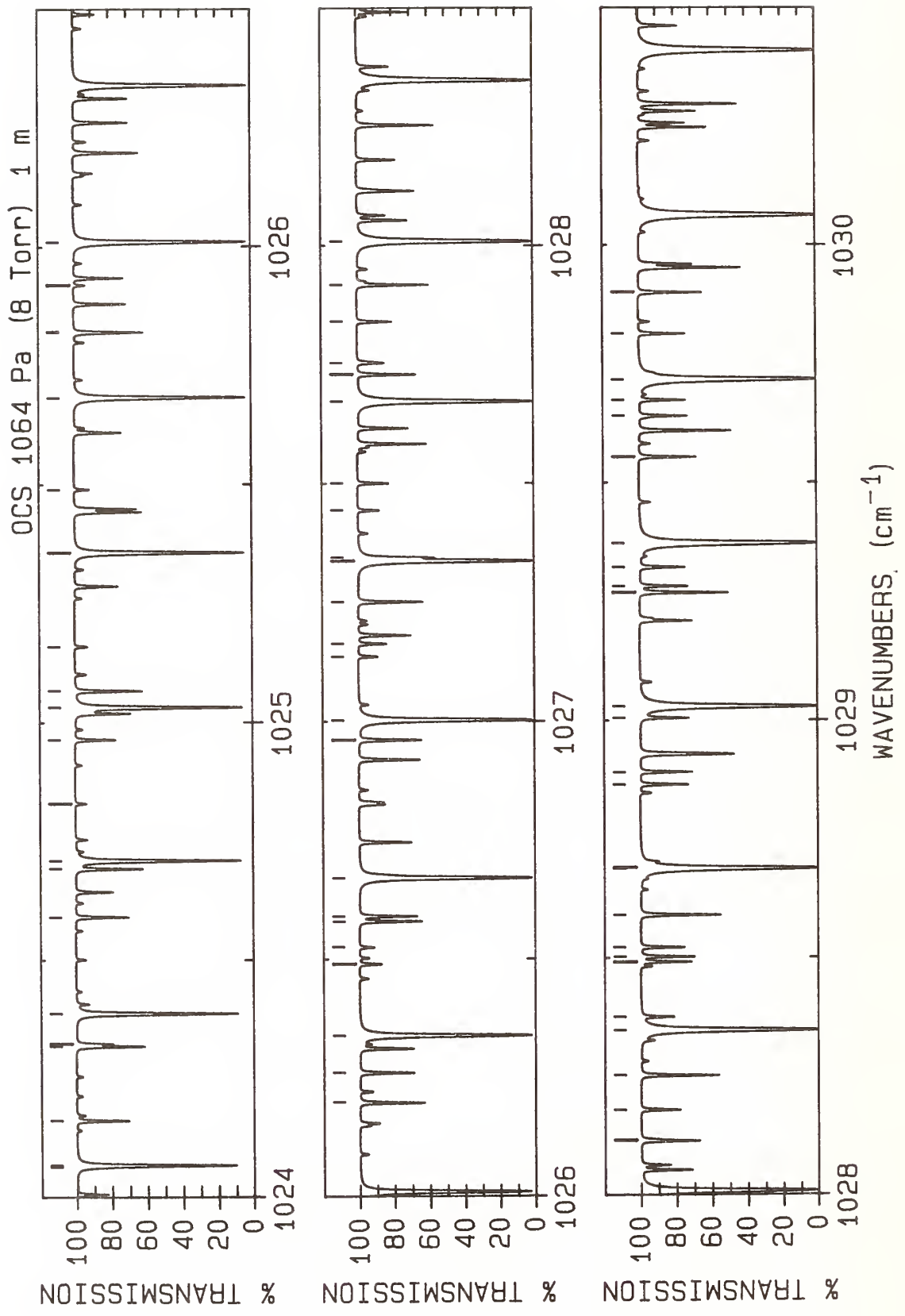

LINE #	WAVENUMBER(lnc) (cm ⁻¹)	LOWER STATE (cm ⁻¹)	INTENSITY (cm/molecule)	ASSIGNMENT ROTATION BAND	LINE #	WAVENUMBER(lnc) (cm ⁻¹)	LOWER STATE (cm ⁻¹)	INTENSITY (cm/molecule)	ASSIGNMENT ROTATION BAND
1	1024.063 59(23)	438.37	0.116E-22	P(46) X	36	1027.344 38(10)*	907.50	0.659E-22	P(15) D
2	1024.068 526(21)*	817.21	0.420E-21	P(63) A	37	1027.443 87(8)*	1558.62	0.210E-22	P(71) C
3	1024.163 21(5)	69.15	0.541E-22	R(18) T	38	1027.500 90(8)*	1472.41	0.308E-22	P(68) B
4	1024.319 33(10)*	970.60	0.741E-22	P(23) D	39	1027.672 469(15)*	558.74	0.124E-20	P(52) A
5	1024.324 62(25)	676.72	0.333E-22	P(58) P	40	1027.729 03(10)*	901.44	0.634E-22	P(14) D
6	1024.388 173(20)*	791.70	0.469E-21	P(62) A	41	1027.753 15(7)*	1529.81	0.239E-22	P(70) C
7	1024.590 76(5)	76.83	0.548E-22	R(19) T	42	1027.840 21(8)*	1444.85	0.348E-22	P(67) B
8	1024.692 34(10)*	961.29	0.742E-22	P(22) D	43	1027.917 65(24)	446.25	0.837E-22	P(47) P
9	1024.709 447(19)*	766.58	0.522E-21	P(61) A	44	1028.009 458(15)*	537.67	0.134E-20	P(51) A
10	1024.829 76(15)	1707.48	0.107E-22	P(76) B	45	1028.115 13(10)*	895.77	0.605E-22	P(13) D
11	1024.964 27(25)	631.27	0.402E-22	P(56) P	46	1028.180 69(8)*	1417.69	0.392E-22	P(66) B
12	1025.032 339(18)*	741.87	0.580E-21	P(60) A	47	1028.253 19(24)	427.66	0.897E-22	P(46) P
13	1025.066 83(10)*	952.40	0.740E-22	P(21) D	48	1028.347 964(15)*	517.00	0.146E-20	P(50) A
14	1025.159 34(13)*	1676.68	0.123E-22	P(75) B	49	1028.376 24(7)*	1473.41	0.307E-22	P(68) C
15	1025.356 838(18)*	717.57	0.643E-21	P(59) A	50	1028.491 70(5)	164.16	0.522E-22	R(28) T
16	1025.490 17(12)*	1646.29	0.141E-22	P(74) B	51	1028.502 65(10)*	890.52	0.573E-22	P(12) D
17	1025.682 934(17)*	693.67	0.711E-21	P(58) A	52	1028.522 34(7)*	1390.93	0.441E-22	P(65) B
18	1025.820 19(10)*	935.82	0.726E-22	P(19) D	53	1028.590 17(24)	409.47	0.960E-22	P(45) P
19	1025.822 25(11)*	1616.30	0.161E-22	P(73) B	54	1028.687 978(14)*	496.74	0.158E-20	P(49) A
20	1025.920 26(12)*	1708.71	0.107E-22	P(76) C	55	1028.690 03(6)*	1445.81	0.347E-22	P(67) C
21	1026.010 616(17)*	670.17	0.784E-21	P(57) A	56	1028.865 14(7)*	1364.57	0.495E-22	P(64) B
22	1026.199 07(10)*	928.13	0.714E-22	P(18) D	57	1028.891 61(10)*	885.66	0.538E-22	P(11) D
23	1026.261 93(24)	545.09	0.570E-22	P(52) P	58	1029.005 32(6)*	1418.62	0.391E-22	P(66) C
24	1026.339 874(16)*	647.08	0.863E-21	P(56) A	59	1029.029 490(14)*	476.88	0.171E-20	P(48) A
25	1026.490 09(10)*	1557.54	0.210E-22	P(71) B	60	1029.268 44(24)	374.27	0.109E-21	P(43) P
26	1026.525 14(10)*	1647.46	0.141E-22	P(74) C	61	1029.281 99(10)*	881.21	0.500E-22	P(10) D
27	1026.579 39(10)*	920.85	0.699E-22	P(17) D	62	1029.322 11(6)*	1391.83	0.440E-22	P(65) C
28	1026.590 11(24)	524.53	0.618E-22	P(51) P	63	1029.371 69(5)	188.01	0.497E-22	R(30) T
29	1026.670 699(16)*	624.39	0.947E-21	P(55) A	64	1029.372 491(14)*	457.42	0.184E-20	P(47) A
30	1026.961 16(10)*	913.98	0.681E-22	P(16) D	65	1029.554 17(7)*	1313.07	0.619E-22	P(62) B
31	1027.003 079(15)*	602.10	0.104E-20	P(54) A	66	1029.640 39(6)*	1365.45	0.494E-22	P(64) C
32	1027.136 11(8)*	1587.83	0.184E-22	P(72) C	67	1029.673 79(10)*	877.17	0.459E-22	P(9) D
33	1027.162 77(9)*	1500.39	0.272E-22	P(69) B	68	1029.716 972(14)*	438.37	0.198E-20	P(46) A
34	1027.250 94(24)	484.60	0.723E-22	P(49) P	69	1029.813 50(5)	200.54	0.483E-22	R(31) T
35	1027.337 006(15)*	580.22	0.113E-20	P(53) A	70	1029.900 38(7)*	1287.93	0.690E-22	P(61) B

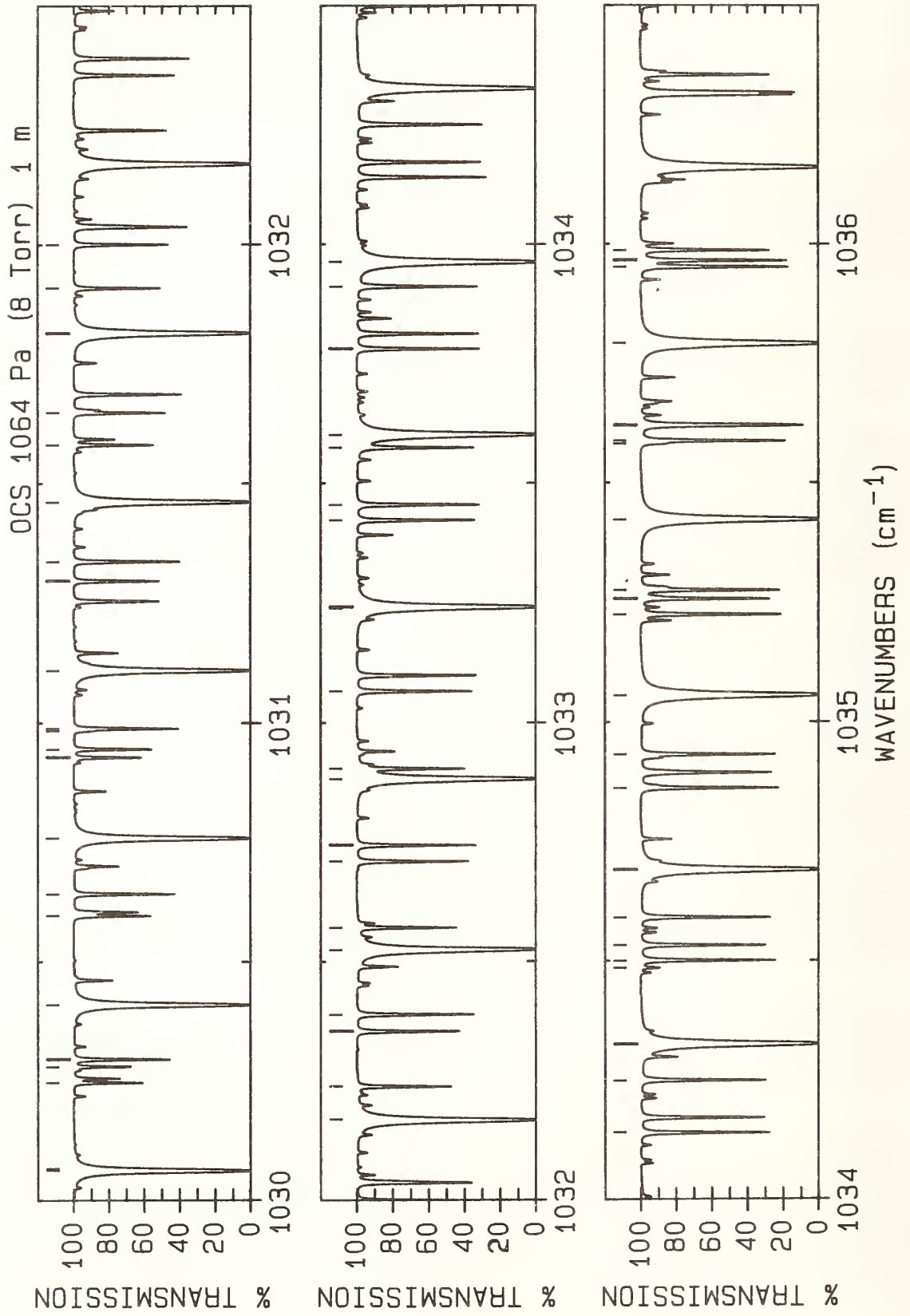

LINE #	WAVENUMBER(unc) (cm ⁻¹)	LOWER STATE (cm ⁻¹)	INTENSITY (cm/molecule)	ASSIGNMENT ROTATION BAND	LINE #	WAVENUMBER(unc) (cm ⁻¹)	LOWER STATE (cm ⁻¹)	INTENSITY (cm/molecule)	ASSIGNMENT ROTATION BAND
1	1030.062 924(14)*	419.73	0.212E-20	P(45) A	36	1033.423 01(6)*	1058.74	0.181E-21	P(51) B
2	1030.067 01(10)*	873.53	0.416E-22	P(8) D	37	1033.455 22(24)	196.27	0.188E-21	P(31) P
3	1030.247 71(7)*	1263.19	0.768E-22	P(60) B	38	1033.574 42(6)*	1080.42	0.165E-21	P(52) C
4	1030.281 39(6)*	1313.90	0.618E-22	P(62) C	39	1033.601 504(14)*	255.53	0.369E-20	P(35) A
5	1030.296 48(24)	324.44	0.129E-21	P(40) P	40	1033.781 18(6)*	1038.05	0.196E-21	P(50) B
6	1030.410 338(14)*	401.49	0.227E-20	P(44) A	41	1033.911 69(6)*	1059.31	0.180E-21	P(51) C
7	1030.596 16(7)*	1238.86	0.852E-22	P(59) B	42	1033.963 095(13)*	241.34	0.384E-20	P(34) A
8	1030.641 96(24)	308.62	0.136E-21	P(39) P	43	1034.140 40(6)*	1017.76	0.213E-21	P(49) B
9	1030.759 206(14)*	383.65	0.242E-20	P(43) A	44	1034.250 40(6)*	1038.59	0.196E-21	P(50) C
10	1030.928 30(6)*	1263.97	0.766E-22	P(60) C	45	1034.326 064(13)*	227.55	0.399E-20	P(33) A
11	1030.945 71(7)*	1214.93	0.944E-22	P(58) B	46	1034.485 56(10)*	860.18	0.167E-22	R(2) D
12	1030.983 89(14)	1474.93	0.109E-22	P(22) H	47	1034.500 67(6)*	997.88	0.230E-21	P(48) B
13	1030.988 83(24)	293.19	0.143E-21	P(38) P	48	1034.532 41(24)	160.67	0.202E-21	P(28) P
14	1031.109 519(14)*	366.22	0.257E-20	P(42) A	49	1034.590 54(6)*	1018.28	0.213E-21	P(49) C
15	1031.296 37(6)*	1191.40	0.104E-21	P(57) B	50	1034.690 403(13)*	214.17	0.413E-20	P(32) A
16	1031.337 08(24)	278.16	0.150E-21	P(37) P	51	1034.861 97(6)*	978.40	0.249E-21	P(47) B
17	1031.461 269(14)*	349.19	0.273E-20	P(41) A	52	1034.932 11(6)*	998.38	0.230E-21	P(48) C
18	1031.581 09(6)*	1215.65	0.942E-22	P(58) C	53	1035.056 106(13)*	201.19	0.426E-20	P(31) A
19	1031.648 12(6)*	1168.28	0.115E-21	P(56) B	54	1035.224 30(6)*	959.33	0.268E-21	P(46) B
20	1031.814 448(14)*	332.57	0.289E-20	P(40) A	55	1035.257 13(24)	138.90	0.209E-21	P(26) P
21	1031.909 68(6)*	1192.10	0.104E-21	P(57) C	56	1035.275 11(6)*	978.88	0.248E-21	P(47) C
22	1032.000 95(6)*	1145.56	0.126E-21	P(55) B	57	1035.423 167(13)*	188.62	0.438E-20	P(30) A
23	1032.169 048(14)*	316.35	0.305E-20	P(39) A	58	1035.581 55(11)	861.08	0.168E-22	P(41) R
24	1032.239 73(6)*	1168.96	0.115E-21	P(56) C	59	1035.587 67(6)*	940.66	0.287E-21	P(45) B
25	1032.354 86(6)*	1123.25	0.139E-21	P(54) B	60	1035.619 52(6)*	959.78	0.267E-21	P(46) C
26	1032.390 06(24)	235.44	0.170E-21	P(34) P	61	1035.621 46(24)	128.62	0.211E-21	P(25) P
27	1032.525 061(14)*	300.54	0.321E-20	P(38) A	62	1035.791 578(13)*	176.45	0.450E-20	P(29) A
28	1032.571 23(6)*	1146.22	0.126E-21	P(55) C	63	1035.952 06(6)*	922.39	0.308E-21	P(44) B
29	1032.709 85(6)*	1101.34	0.152E-21	P(53) B	64	1035.965 35(6)*	941.10	0.287E-21	P(45) C
30	1032.743 77(24)	221.99	0.177E-21	P(33) P	65	1035.965 9	1761.33	0.102E-22	P(59) F
31	1032.882 479(14)*	285.13	0.337E-20	P(37) A	66	1035.987 08(24)	118.72	0.213E-21	P(24) P
32	1032.904 18(6)*	1123.88	0.138E-21	P(54) C					
33	1033.065 90(6)*	1079.84	0.166E-21	P(52) B					
34	1033.238 58(6)*	1101.95	0.152E-21	P(53) C					
35	1033.241 296(14)*	270.13	0.353E-20	P(36) A					

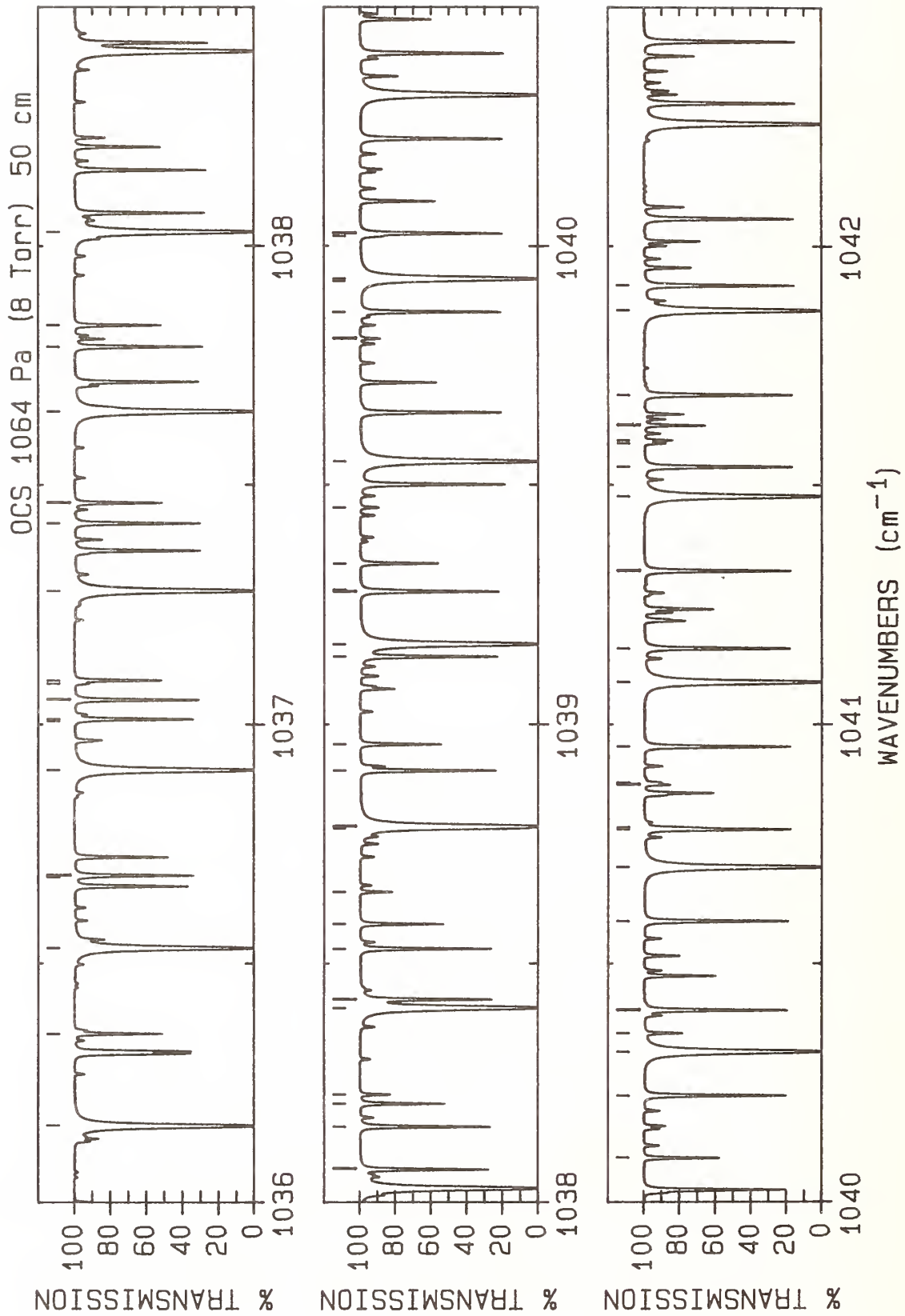

LINE #	WAVENUMBER(unc) (cm ⁻¹)	LOWER STATE (cm ⁻¹)	INTENSITY (cm/molecule)	ASSIGNMENT ROTATION BAND	LINE #	WAVENUMBER(unc) (cm ⁻¹)	LOWER STATE (cm ⁻¹)	INTENSITY (cm/molecule)	ASSIGNMENT ROTATION BAND
1	1036.161 336(13)*	164.69	0.460E-20	P(28) A	36	1039.280 84(15)	703.89	0.271E-22	P(30) Q
2	1036.354 01(24)	109.23	0.214E-21	P(23) P	37	1039.335 59(24)	47.49	0.189E-21	P(15) P
3	1036.532 432(13)*	153.34	0.469E-20	P(27) A	38	1039.452 54(9)*	1525.43	0.355E-22	P(48) G
4	1036.679 61(9)*	1696.18	0.176E-22	P(56) G	39	1039.548 795(12)*	77.08	0.480E-20	P(19) A
5	1036.683 89(6)*	887.08	0.351E-21	P(42) B	40	1039.805 82(9)*	1505.91	0.383E-22	P(47) G
6	1036.904 863(12)*	142.38	0.477E-20	P(26) A	41	1039.861 94(6)*	762.31	0.531E-21	P(34) C
7	1037.007 04(85)	1690.60	0.137E-22	P(56) F	42	1039.926 41(10)*	907.50	0.712E-22	R(15) D
8	1037.011 29(6)*	887.47	0.350E-21	P(42) C	43	1039.931 717(12)*	69.37	0.472E-20	P(18) A
9	1037.051 32(6)*	870.04	0.373E-21	P(41) B	44	1040.020 46(16)	680.52	0.285E-22	P(28) Q
10	1037.051 53(10)	455.95	0.209E-22	R(47) T	45	1040.026 63(6)*	748.25	0.553E-21	P(33) B
11	1037.085 21(13)	783.50	0.218E-22	P(36) Q	46	1040.093 66(24)	36.02	0.173E-21	P(13) P
12	1037.091 73(24)	91.42	0.213E-21	P(21) P	47	1040.224 50(6)*	748.49	0.553E-21	P(33) C
13	1037.278 622(12)*	131.84	0.483E-20	P(25) A	48	1040.315 930(12)*	62.07	0.462E-20	P(17) A
14	1037.419 76(6)*	853.39	0.396E-21	P(40) B	49	1040.354 79(10)*	913.98	0.733E-22	R(16) D
15	1037.462 52(24)	83.11	0.211E-21	P(20) P	50	1040.402 97(6)*	734.85	0.574E-21	P(32) B
16	1037.653 705(12)*	121.70	0.487E-20	P(24) A	51	1040.588 43(6)*	735.07	0.573E-21	P(32) C
17	1037.789 19(6)*	837.16	0.418E-21	P(39) B	52	1040.701 431(12)*	55.17	0.450E-20	P(16) A
18	1037.834 59(24)	75.19	0.209E-21	P(19) P	53	1040.780 28(6)*	721.86	0.594E-21	P(31) B
19	1038.030 106(12)*	111.96	0.489E-20	P(23) A	54	1040.784 58(10)*	920.85	0.751E-22	R(17) D
20	1038.069 86(6)*	837.49	0.418E-21	P(39) C	55	1040.874 18(9)*	1449.79	0.476E-22	P(44) G
21	1038.159 63(6)*	821.33	0.441E-21	P(38) B	56	1040.878 59(17)	658.87	0.295E-22	P(26) R
22	1038.207 94(24)	67.68	0.205E-21	P(18) P	57	1040.953 74(6)*	722.07	0.593E-21	P(31) C
23	1038.227 02(10)*	885.66	0.593E-22	R(11) D	58	1041.088 215(11)*	48.68	0.436E-20	P(15) A
24	1038.407 820(12)*	102.63	0.490E-20	P(22) A	59	1041.158 56(6)*	709.27	0.612E-21	P(30) B
25	1038.425 51(6)*	821.64	0.441E-21	P(38) C	60	1041.320 41(6)*	709.47	0.612E-21	P(30) C
26	1038.531 06(6)*	805.90	0.464E-21	P(37) B	61	1041.476 280(11)*	42.60	0.419E-20	P(14) A
27	1038.582 55(24)	60.55	0.201E-21	P(17) P	62	1041.537 80(6)*	697.09	0.629E-21	P(29) B
28	1038.649 76(10)*	890.52	0.627E-22	R(12) D	63	1041.587 18(19)	1426.24	0.393E-22	P(43) E
29	1038.782 54(6)*	806.20	0.464E-21	P(37) C	64	1041.593 35(9)*	1414.41	0.543E-22	P(42) G
30	1038.786 842(12)*	93.71	0.489E-20	P(21) A	65	1041.624 85(24)	17.81	0.131E-21	P(9) P
31	1038.903 48(6)*	790.88	0.487E-21	P(36) B	66	1041.688 44(6)*	697.27	0.629E-21	P(29) C
32	1038.958 44(24)	53.83	0.195E-21	P(16) P	67	1041.865 622(11)*	36.92	0.400E-20	P(13) A
33	1039.140 96(6)*	791.16	0.487E-21	P(36) C	68	1041.918 01(6)*	685.31	0.645E-21	P(28) B
34	1039.167 169(12)*	85.19	0.485E-20	P(20) A					
35	1039.276 88(6)*	776.26	0.510E-21	P(35) B					

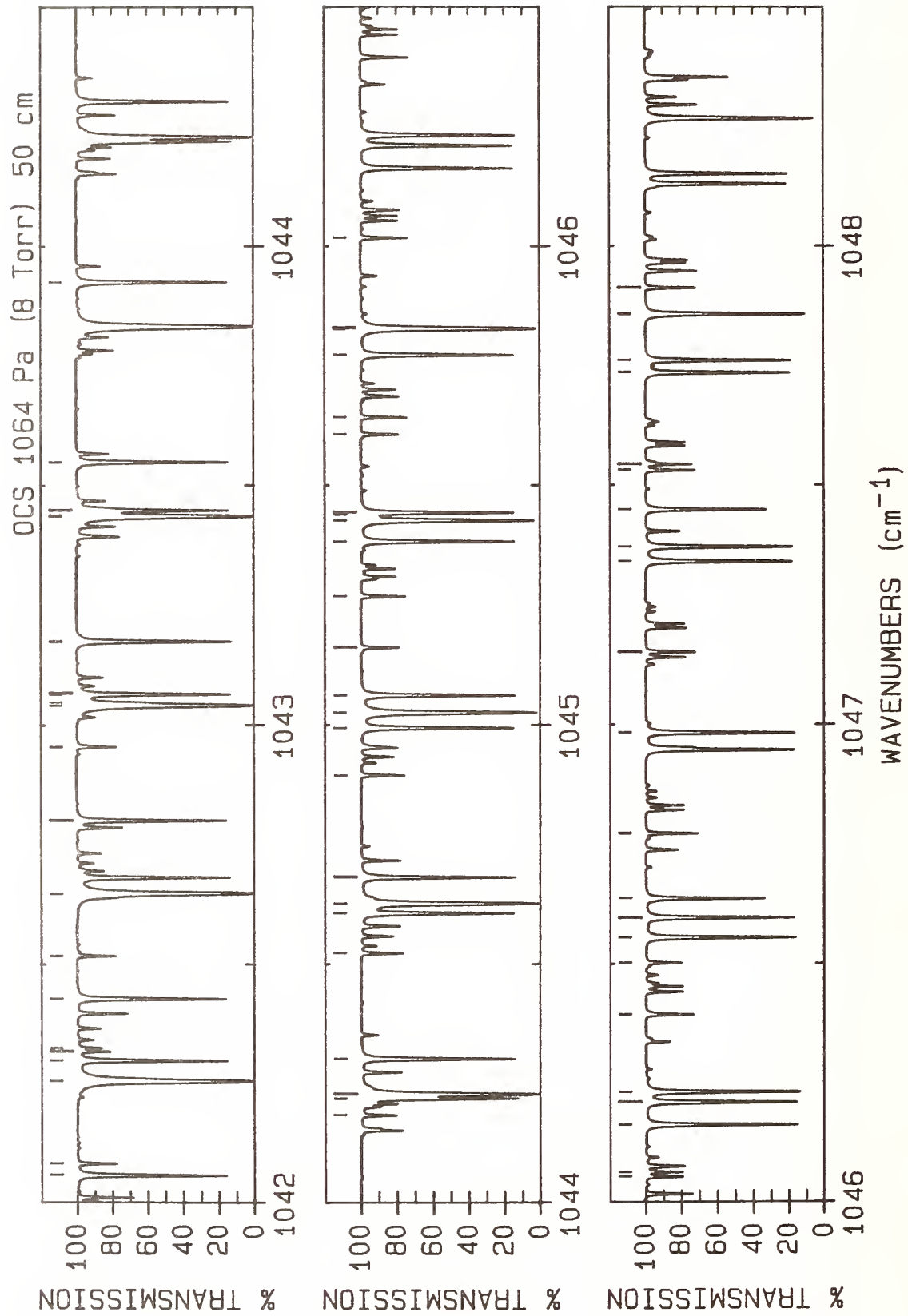

LINE #	WAVENUMBER(unc) (cm ⁻¹)	LOWER STATE (cm ⁻¹)	INTENSITY (cm/molecule)	ASSIGNMENT ROTATION BAND	LINE #	WAVENUMBER(unc) (cm ⁻¹)	LOWER STATE (cm ⁻¹)	INTENSITY (cm/molecule)	ASSIGNMENT ROTATION BAND
1	1042.057 84(6)*	685.49	0.644E-21	P(28) C	36	1045.267 82(9)*	1261.88	0.891E-22	P(32) G
2	1042.082 47(10)*	943.90	0.784E-22	R(20) D	37	1045.382 69(6)*	597.60	0.684E-21	P(19) B
3	1042.256 237(11)*	31.64	0.379E-20	P(12) A	38	1045.426 691(11)*	4.06	0.145E-20	P(4) A
4	1042.299 18(6)*	673.94	0.659E-21	P(27) B	39	1045.438 55(15)	1409.32	0.103E-22	R(13) H
5	1042.317 93(9)*	1380.65	0.612E-22	P(40) G	40	1045.443 26(6)*	597.68	0.684E-21	P(19) C
6	1042.325 25(14)	1391.67	0.446E-22	P(41) E	41	1045.606 59(10)*	1023.17	0.739E-22	R(28) D
7	1042.428 59(6)*	674.10	0.658E-21	P(27) C	42	1045.642 12(9)*	1248.86	0.922E-22	P(31) G
8	1042.517 95(10)*	952.40	0.789E-22	R(21) D	43	1045.772 37(6)*	589.88	0.674E-21	P(18) B
9	1042.648 124(11)*	26.78	0.356E-20	P(11) A	44	1045.826 14(6)*	589.95	0.674E-21	P(18) C
10	1042.800 70(6)*	663.13	0.670E-21	P(26) C	45	1045.828 655(11)*	2.43	0.110E-20	P(3) A
11	1042.954 86(10)*	961.29	0.790E-22	R(22) D	46	1046.017 61(9)*	1236.25	0.952E-22	P(30) G
12	1043.041 278(11)*	22.31	0.331E-20	P(10) A	47	1046.053 62(10)*	1034.89	0.722E-22	R(29) D
13	1043.047 79(9)*	1348.52	0.684E-22	P(38) G	48	1046.063 33(7)	1243.17	0.709E-22	P(31) E
14	1043.064 37(6)*	652.42	0.680E-21	P(25) B	49	1046.162 97(6)*	582.57	0.661E-21	P(17) B
15	1043.066 39(11)	1358.72	0.500E-22	P(39) E	50	1046.210 35(6)*	582.63	0.661E-21	P(17) C
16	1043.174 17(6)*	652.56	0.680E-21	P(25) C	51	1046.231 870(11)*	1.22	0.735E-21	P(2) A
17	1043.175 94(24)	5.94	0.773E-22	P(5) P	52	1046.394 27(9)*	1224.04	0.978E-22	P(29) G
18	1043.435 697(11)*	18.26	0.304E-20	P(9) A	53	1046.502 13(10)*	1047.02	0.703E-22	R(30) D
19	1043.438 13(10)	1342.85	0.527E-22	P(38) E	54	1046.554 52(6)*	575.66	0.644E-21	P(16) B
20	1043.448 40(6)*	642.27	0.688E-21	P(24) B	55	1046.595 89(6)*	575.72	0.644E-21	P(16) C
21	1043.548 99(6)*	642.40	0.687E-21	P(24) C	56	1046.636 335(11)*	0.41	0.369E-21	P(1) A
22	1043.925 15(6)*	632.64	0.692E-21	P(23) C	57	1046.772 10(9)*	1212.24	0.100E-21	P(28) G
23	1044.184 03(8)	1312.34	0.582E-22	P(36) E	58	1046.772 83(15)	1427.61	0.116E-22	R(16) I
24	1044.219 29(6)*	623.18	0.695E-21	P(22) B	59	1046.982 76(6)*	569.22	0.625E-21	P(15) C
25	1044.228 322(11)*	11.36	0.245E-20	P(7) A	60	1047.151 08(9)*	1200.85	0.102E-21	P(27) G
26	1044.302 67(6)*	623.29	0.694E-21	P(22) C	61	1047.340 38(6)*	563.07	0.602E-21	P(14) B
27	1044.522 85(9)*	1289.13	0.825E-22	P(34) G	62	1047.370 96(6)*	563.12	0.601E-21	P(14) C
28	1044.606 15(6)*	614.25	0.694E-21	P(21) B	63	1047.449 009(11)*	0.00	0.370E-21	R(0) A
29	1044.626 523(11)*	8.52	0.213E-20	P(6) A	64	1047.531 20(9)*	1189.87	0.104E-21	P(26) G
30	1044.681 52(6)*	614.35	0.694E-21	P(21) C	65	1047.543 17(24)	5.94	0.932E-22	R(5) P
31	1044.894 73(9)*	1275.30	0.859E-22	P(33) G	66	1047.734 71(6)*	557.38	0.575E-21	P(13) B
32	1044.993 95(6)*	605.72	0.690E-21	P(20) B	67	1047.760 49(6)*	557.42	0.575E-21	P(13) C
33	1045.025 980(11)*	6.09	0.179E-20	P(5) A	68	1047.856 48(10)*	1085.84	0.639E-22	R(33) D
34	1045.061 72(6)*	605.81	0.690E-21	P(20) C	69	1047.857 217(11)*	0.41	0.739E-21	R(1) A
35	1045.161 01(10)*	1011.84	0.753E-22	R(27) D	70	1047.912 45(9)*	1179.29	0.106E-21	P(25) G

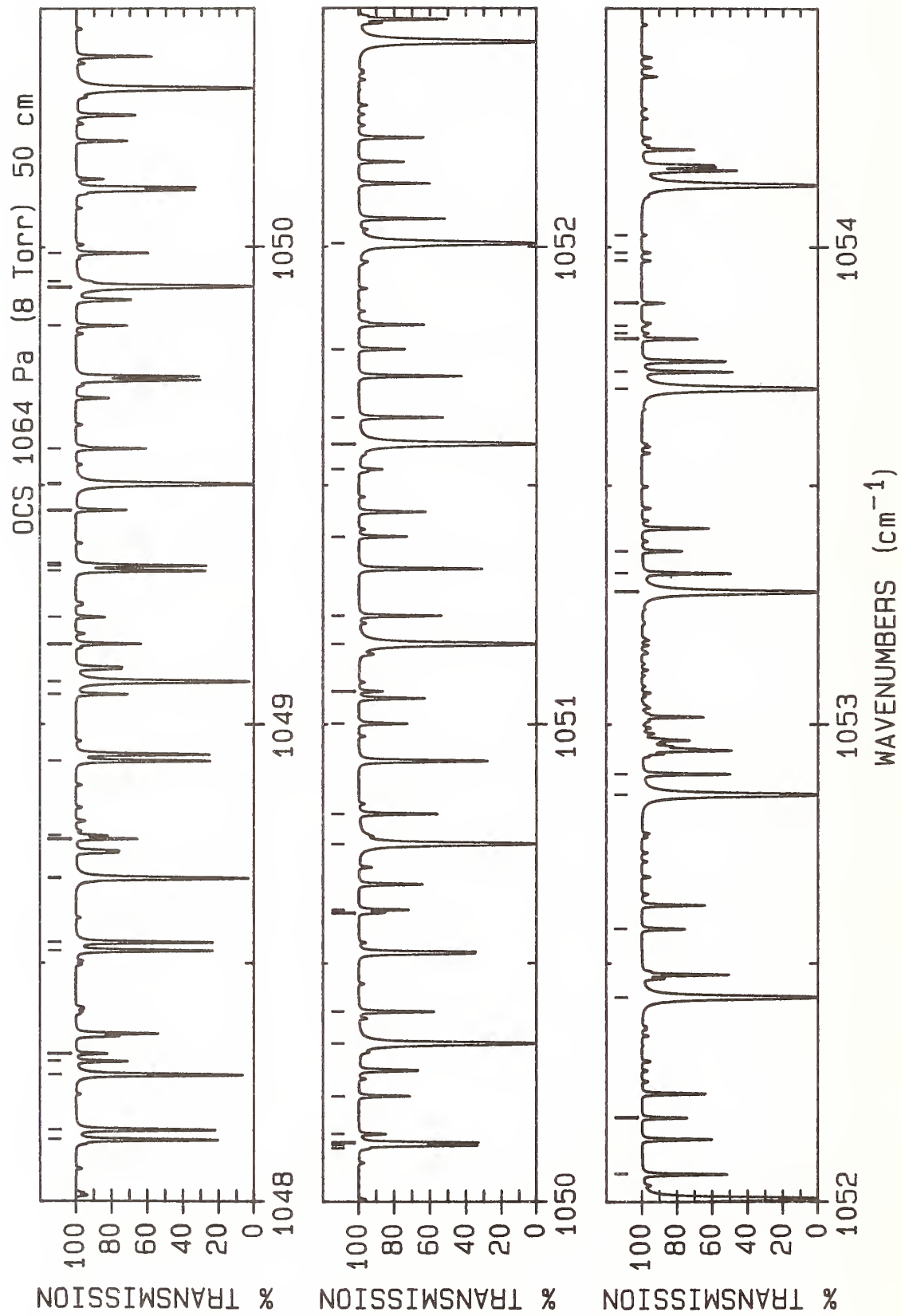

LINE #	WAVENUMBER(unc) (cm ⁻¹)	LOWER STATE (cm ⁻¹)	INTENSITY (cm/molecule)	ASSIGNMENT ROTATION BAND	LINE #	WAVENUMBER(unc) (cm ⁻¹)	LOWER STATE (cm ⁻¹)	INTENSITY (cm/molecule)	ASSIGNMENT ROTATION BAND
1	1048.129 95(6)*	552.11	0.545E-21	P(12)	36	1050.611 94(9)*	1116.63	0.105E-21	P(18)
2	1048.151 35(6)*	552.14	0.545E-21	P(12)	37	1050.749 534(11)*	14.61	0.312E-20	R(8)
3	1048.266 670(11)*	1.22	0.110E-20	R(2)	38	1050.812 66(24)	36.02	0.189E-21	R(13)
4	1048.294 82(9)*	1169.12	0.107E-21	P(24)	39	1051.001 86(9)*	1109.30	0.103E-21	P(17)
5	1048.310 90(10)*	1099.58	0.616E-22	R(34)	40	1051.069 04(9)*	1190.54	0.464E-22	R(40)
6	1048.526 12(6)*	547.23	0.512E-21	P(11)	41	1051.167 702(11)*	18.26	0.340E-20	R(9)
7	1048.543 53(6)*	547.26	0.512E-21	P(11)	42	1051.226 88(24)	41.56	0.197E-21	R(14)
8	1048.677 369(11)*	2.43	0.147E-20	R(3)	43	1051.392 83(9)*	1102.39	0.101E-21	P(16)
9	1048.678 29(9)*	1159.35	0.108E-21	P(23)	44	1051.534 07(9)*	1207.11	0.438E-22	R(41)
10	1048.760 02(24)	14.25	0.134E-21	R(8)	45	1051.587 116(11)*	22.31	0.367E-20	R(10)
11	1048.766 82(10)*	1113.73	0.591E-22	R(35)	46	1051.642 33(24)	47.49	0.204E-21	R(15)
12	1048.923 21(6)*	542.76	0.476E-21	P(10)	47	1051.784 83(9)*	1095.88	0.976E-22	P(15)
13	1049.062 87(9)*	1149.99	0.108E-21	P(22)	48	1052.007 777(11)*	26.78	0.392E-20	R(11)
14	1049.089 312(11)*	4.06	0.182E-20	R(4)	49	1052.059 02(24)	53.83	0.210E-21	R(16)
15	1049.168 09(24)	17.81	0.147E-21	R(9)	50	1052.177 86(9)*	1089.77	0.941E-22	P(14)
16	1049.224 23(10)*	1128.29	0.566E-22	R(36)	51	1052.429 686(11)*	31.64	0.415E-20	R(12)
17	1049.321 21(6)*	538.70	0.437E-21	P(9)	52	1052.571 92(9)*	1084.07	0.900E-22	P(13)
18	1049.331 84(6)*	538.72	0.437E-21	P(9)	53	1052.852 844(11)*	36.92	0.436E-20	R(13)
19	1049.336 52(18)	1802.17	0.100E-22	P(33)	54	1052.896 11(24)	67.68	0.220E-21	R(18)
20	1049.448 53(9)*	1141.04	0.108E-21	P(21)	55	1053.277 251(12)*	42.60	0.454E-20	R(14)
21	1049.502 500(11)*	6.09	0.216E-20	R(5)	56	1053.316 51(24)	75.19	0.223E-21	R(19)
22	1049.504 64(7)	1144.28	0.828E-22	P(22)	57	1053.363 09(9)*	1073.90	0.804E-22	P(11)
23	1049.577 39(24)	21.77	0.158E-21	R(10)	58	1053.702 911(12)*	48.68	0.470E-20	R(15)
24	1049.835 26(9)*	1132.50	0.108E-21	P(20)	59	1053.738 16(24)	83.11	0.225E-21	R(20)
25	1049.916 933(11)*	8.52	0.249E-20	R(6)	60	1053.807 30(8)	1068.16	0.600E-22	P(11)
26	1049.928 74(20)	1775.25	0.108E-22	P(31)	61	1053.807 44(8)	1068.16	0.600E-22	P(11)
27	1049.987 91(24)	26.12	0.169E-21	R(11)	62	1053.819 10(17)	1667.40	0.126E-22	P(21)
28	1050.112 43(14)	1493.97	0.126E-22	R(24)	63	1053.835 59(15)	1586.54	0.108E-22	R(32)
29	1050.119 98(6)*	531.80	0.350E-21	P(7)	64	1053.882 51(9)*	1296.03	0.318E-22	R(46)
30	1050.125 43(6)*	531.81	0.350E-21	P(7)	65	1053.883 01(18)	1667.59	0.126E-22	P(21)
31	1050.143 59(10)*	1158.61	0.515E-22	R(38)	66	1053.971 65(18)	530.75	0.180E-22	R(7)
32	1050.223 07(9)*	1124.36	0.107E-21	P(19)	67	1053.988 75(18)	530.76	0.180E-22	R(7)
33	1050.332 611(11)*	11.36	0.281E-20	R(7)	68	1054.026 02(15)	1599.65	0.104E-22	R(33)
34	1050.399 67(24)	30.87	0.179E-21	R(12)					
35	1050.605 55(9)*	1174.37	0.489E-22	R(39)					

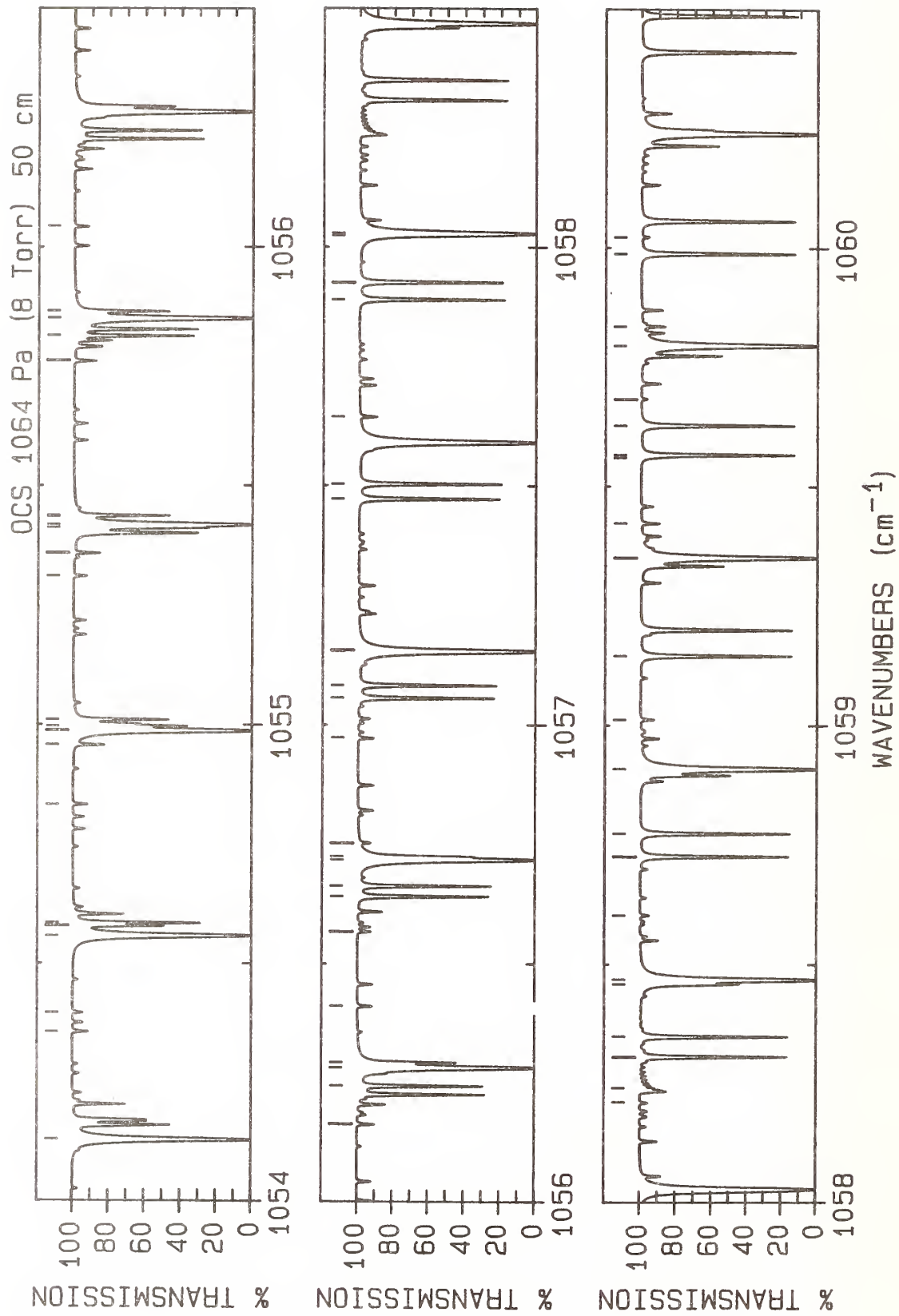

LINE #	WAVENUMBER(unc) (cm ⁻¹)	LOWER STATE (cm ⁻¹)	INTENSITY (cm/molecule)	ASSIGNMENT ROTATION BAND	LINE #	WAVENUMBER(unc) (cm ⁻¹)	LOWER STATE (cm ⁻¹)	INTENSITY (cm/molecule)	ASSIGNMENT ROTATION BAND
1	1054.129 823(12)*	55.17	0.485E-20	R(16) A	36	1056.972 68(9)*	1048.26	0.169E-22	P(2) G
2	1054.356 92(9)*	1315.02	0.296E-22	R(47) D	37	1057.056 07(6)*	538.70	0.509E-21	R(9) B
3	1054.397 03(18)	533.94	0.201E-22	R(8) R	38	1057.082 39(6)*	538.72	0.509E-21	R(9) C
4	1054.557 991(12)*	62.07	0.496E-20	R(17) A	39	1057.153 470(12)*	111.96	0.520E-20	R(23) A
5	1054.578 23(6)*	522.86	0.205E-21	R(3) B	40	1057.156 41(24)	160.67	0.214E-21	R(28) P
6	1054.583 94(6)*	522.86	0.205E-21	R(3) C	41	1057.472 19(6)*	542.76	0.551E-21	R(10) B
7	1054.585 19(24)	100.13	0.228E-21	R(22) P	42	1057.503 34(6)*	542.79	0.551E-21	R(10) C
8	1054.832 92(9)*	1334.42	0.275E-22	R(48) D	43	1057.643 66(18)	573.55	0.322E-22	R(16) Q
9	1054.957 46(9)*	1058.44	0.557E-22	P(7) G	44	1057.889 21(6)*	547.23	0.590E-21	R(11) B
10	1054.987 415(12)*	69.37	0.506E-20	R(18) A	45	1057.925 60(6)*	547.26	0.590E-21	R(11) C
11	1054.988 95(6)*	524.48	0.261E-21	R(4) B	46	1058.023 61(24)	184.01	0.204E-21	R(30) P
12	1054.997 10(6)*	524.49	0.261E-21	R(4) C	47	1058.028 777(13)*	131.84	0.512E-20	R(25) A
13	1055.010 59(24)	109.23	0.227E-21	R(23) P	48	1058.210 34(10)*	1481.48	0.153E-22	R(55) D
14	1055.310 53(9)*	1354.22	0.254E-22	R(49) D	49	1058.241 18(8)	1045.36	0.116E-22	Q(4) E
15	1055.358 54(9)*	1055.59	0.485E-22	P(6) G	50	1058.307 12(6)*	552.11	0.626E-21	R(12) B
16	1055.411 55(6)*	526.52	0.315E-21	R(5) C	51	1058.349 16(6)*	552.14	0.626E-21	R(12) C
17	1055.418 098(12)*	77.08	0.513E-20	R(19) A	52	1058.459 13(24)	196.27	0.199E-21	R(31) P
18	1055.434 57(19)	1635.78	0.120E-22	P(17) M	53	1058.468 348(13)*	142.38	0.506E-20	R(26) A
19	1055.437 23(24)	118.72	0.226E-21	R(24) P	54	1058.602 47(9)*	1047.45	0.171E-22	R(1) G
20	1055.760 60(9)*	1053.15	0.410E-22	P(5) G	55	1058.725 93(6)*	557.38	0.659E-21	R(13) B
21	1055.813 10(6)*	528.95	0.367E-21	R(6) B	56	1058.774 01(6)*	557.42	0.659E-21	R(13) C
22	1055.850 043(12)*	85.19	0.518E-20	R(20) A	57	1058.909 200(13)*	153.34	0.497E-20	R(27) A
23	1055.865 13(24)	128.62	0.224E-21	R(25) P	58	1059.012 36(9)*	1048.26	0.257E-22	R(2) G
24	1056.042 99(18)	550.60	0.272E-22	R(12) R	59	1059.145 64(6)*	563.07	0.689E-21	R(14) B
25	1056.163 65(9)*	1051.11	0.332E-22	P(4) G	60	1059.351 339(13)*	164.69	0.488E-20	R(28) A
26	1056.244 37(6)*	531.81	0.417E-21	R(7) C	61	1059.423 22(9)*	1049.48	0.341E-22	R(3) G
27	1056.283 251(12)*	93.71	0.521E-20	R(21) A	62	1059.560 40(23)	349.19	0.128E-22	R(41) X
28	1056.294 29(24)	138.90	0.222E-21	R(26) P	63	1059.566 24(6)*	569.16	0.716E-21	R(15) B
29	1056.411 57(18)	555.72	0.286E-22	R(13) Q	64	1059.627 61(6)*	569.22	0.716E-21	R(15) C
30	1056.567 67(9)*	1049.48	0.252E-22	P(3) G	65	1059.682 63(10)*	1550.55	0.115E-22	R(58) D
31	1056.640 85(6)*	535.04	0.464E-21	R(8) B	66	1059.794 767(13)*	176.45	0.476E-20	R(29) A
32	1056.662 73(6)*	535.06	0.464E-21	R(8) C	67	1059.835 06(9)*	1051.11	0.424E-22	R(4) G
33	1056.717 726(12)*	102.63	0.522E-20	R(22) A	68	1059.987 74(6)*	575.66	0.739E-21	R(16) B
34	1056.724 72(24)	149.59	0.218E-21	R(27) P	69	1060.022 71(23)	366.22	0.133E-22	R(42) X
35	1056.753 05(10)*	1416.04	0.199E-22	R(52) D					

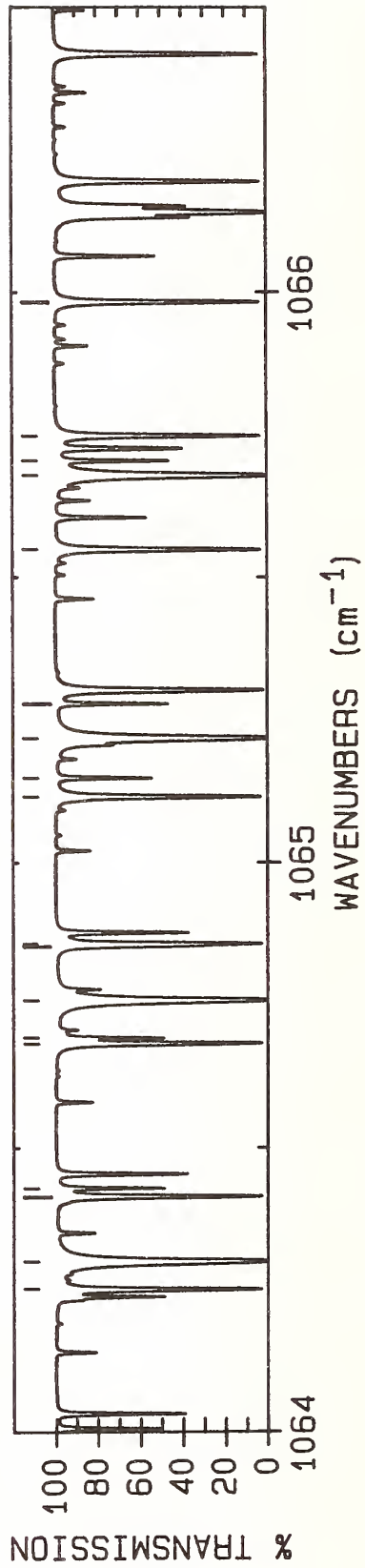
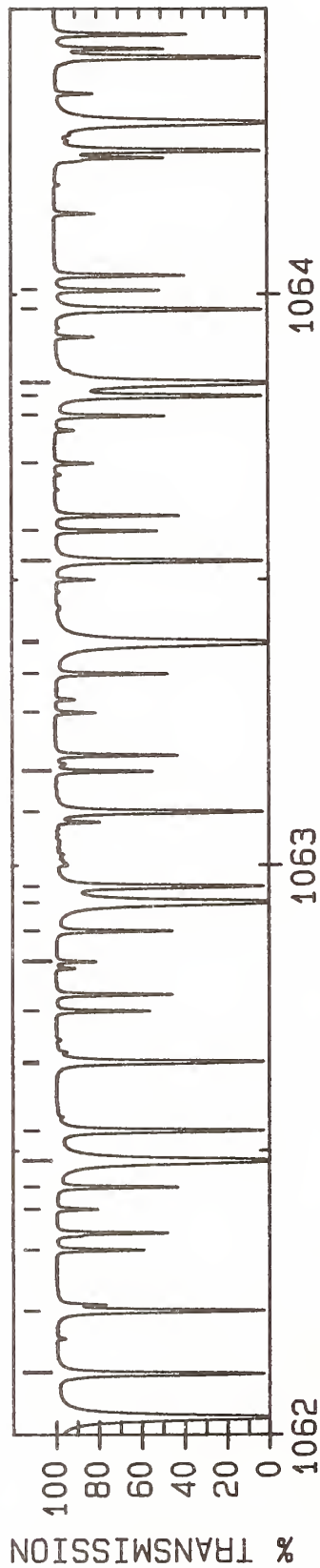
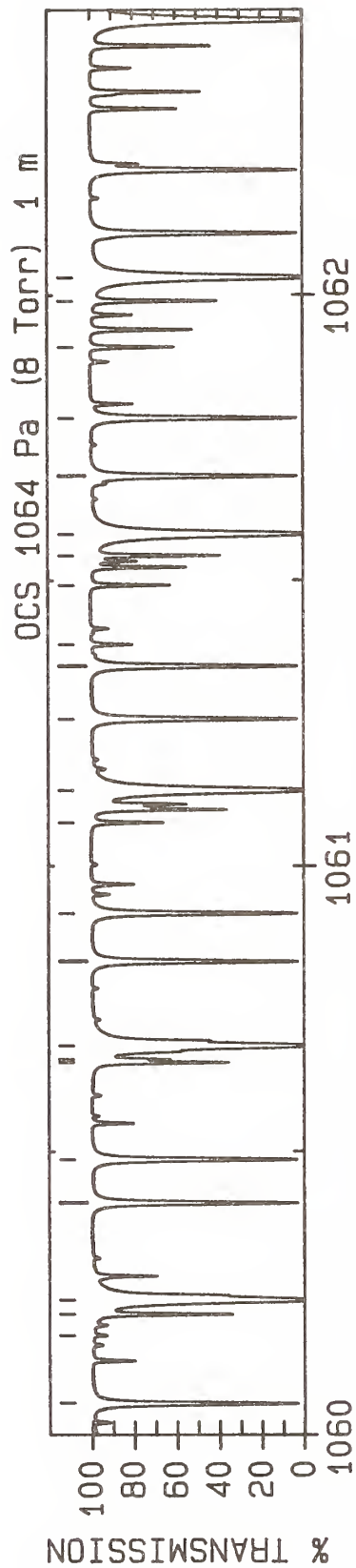

LINE #	WAVENUMBER(unc) (cm ⁻¹)	LOWER STATE (cm ⁻¹)	INTENSITY (cm/molecule)	ASSIGNMENT ROTATION BAND	LINE #	WAVENUMBER(unc) (cm ⁻¹)	LOWER STATE (cm ⁻¹)	INTENSITY (cm/molecule)	ASSIGNMENT ROTATION BAND
1	1060.056 36(6)*	575.72	0.739E-21	R(16) C	36	1062.885 66(24)	340.66	0.130E-21	R(41) P
2	1060.176 77(10)*	1574.38	0.104E-22	R(59) D	37	1062.935 247(14)*	270.13	0.373E-20	R(36) A
3	1060.214 07(24)	249.29	0.173E-21	R(35) P	38	1062.963 36(6)*	632.52	0.805E-21	R(23) B
4	1060.239 490(13)*	188.62	0.464E-20	R(30) A	39	1063.093 94(6)*	632.64	0.805E-21	R(23) C
5	1060.410 14(6)*	582.57	0.759E-21	R(17) B	40	1063.165 09(9)*	1078.78	0.980E-22	R(12) G
6	1060.486 40(6)*	582.63	0.758E-21	R(17) C	41	1063.267 42(15)	692.18	0.329E-22	R(29) R
7	1060.656 05(24)	263.53	0.166E-21	R(36) P	42	1063.335 56(24)	357.27	0.122E-21	R(42) P
8	1060.661 66(9)*	1055.59	0.583E-22	R(6) G	43	1063.389 156(14)*	285.13	0.356E-20	R(37) A
9	1060.685 510(13)*	201.19	0.451E-20	R(31) A	44	1063.392 04(6)*	642.27	0.802E-21	R(24) B
10	1060.833 43(6)*	589.88	0.775E-21	R(18) B	45	1063.533 07(6)*	642.40	0.801E-21	R(24) C
11	1060.917 75(6)*	589.95	0.775E-21	R(18) C	46	1063.585 80(9)*	1084.07	0.103E-21	R(13) G
12	1061.076 43(9)*	1058.44	0.659E-22	R(7) G	47	1063.703 96(15)	704.08	0.322E-22	R(30) R
13	1061.132 833(13)*	214.17	0.437E-20	R(32) A	48	1063.786 81(24)	374.27	0.115E-21	R(43) P
14	1061.257 62(6)*	597.60	0.788E-21	R(19) B	49	1063.821 62(6)*	652.42	0.796E-21	R(25) B
15	1061.350 39(6)*	597.68	0.787E-21	R(19) C	50	1063.844 398(14)*	300.54	0.339E-20	R(38) A
16	1061.388 43(16)	648.43	0.349E-22	R(25) Q	51	1063.973 50(6)*	652.56	0.795E-21	R(25) C
17	1061.492 19(9)*	1061.69	0.731E-22	R(8) G	52	1064.007 52(9)*	1089.77	0.108E-21	R(14) G
18	1061.543 93(24)	293.19	0.151E-21	R(38) P	53	1064.252 10(6)*	662.98	0.787E-21	R(26) B
19	1061.581 464(14)*	227.55	0.422E-20	R(33) A	54	1064.300 978(14)*	316.35	0.322E-20	R(39) A
20	1061.682 71(6)*	605.72	0.797E-21	R(20) B	55	1064.415 24(6)*	663.13	0.786E-21	R(26) C
21	1061.784 33(6)*	605.81	0.797E-21	R(20) C	56	1064.430 25(9)*	1095.88	0.112E-21	R(15) G
22	1061.908 92(9)*	1065.36	0.800E-22	R(9) G	57	1064.683 48(6)*	673.94	0.775E-21	R(27) B
23	1061.989 85(24)	308.62	0.144E-21	R(39) P	58	1064.693 35(24)	409.47	0.102E-21	R(45) P
24	1062.031 406(14)*	241.34	0.406E-20	R(34) A	59	1064.758 903(14)*	332.57	0.305E-20	R(40) A
25	1062.108 69(6)*	614.25	0.803E-21	R(21) B	60	1064.854 00(9)*	1102.39	0.115E-21	R(16) G
26	1062.219 56(6)*	614.35	0.803E-21	R(21) C	61	1064.858 28(6)*	674.10	0.775E-21	R(27) C
27	1062.326 65(9)*	1069.42	0.864E-22	R(10) G	62	1065.115 76(6)*	685.31	0.761E-21	R(28) B
28	1062.398 22(16)	669.58	0.341E-22	R(27) R	63	1065.148 66(24)	427.66	0.949E-22	R(46) P
29	1062.437 09(24)	324.44	0.137E-21	R(40) P	64	1065.218 178(14)*	349.19	0.289E-20	R(41) A
30	1062.482 665(14)*	255.53	0.390E-20	R(35) A	65	1065.278 77(9)*	1109.30	0.118E-21	R(17) G
31	1062.535 58(6)*	623.18	0.806E-21	R(22) B	66	1065.548 94(6)*	697.09	0.746E-21	R(29) B
32	1062.652 89(15)	680.52	0.336E-22	R(28) Q	67	1065.678 810(14)*	366.22	0.272E-20	R(42) A
33	1062.656 10(6)*	623.29	0.805E-21	R(22) C	68	1065.704 57(9)*	1116.63	0.121E-21	R(18) G
34	1062.745 37(9)*	1073.90	0.925E-22	R(11) G	69	1065.748 25(6)*	697.27	0.745E-21	R(29) C
35	1062.832 18(16)	680.68	0.336E-22	R(28) R	70	1065.983 03(6)*	709.27	0.728E-21	R(30) B

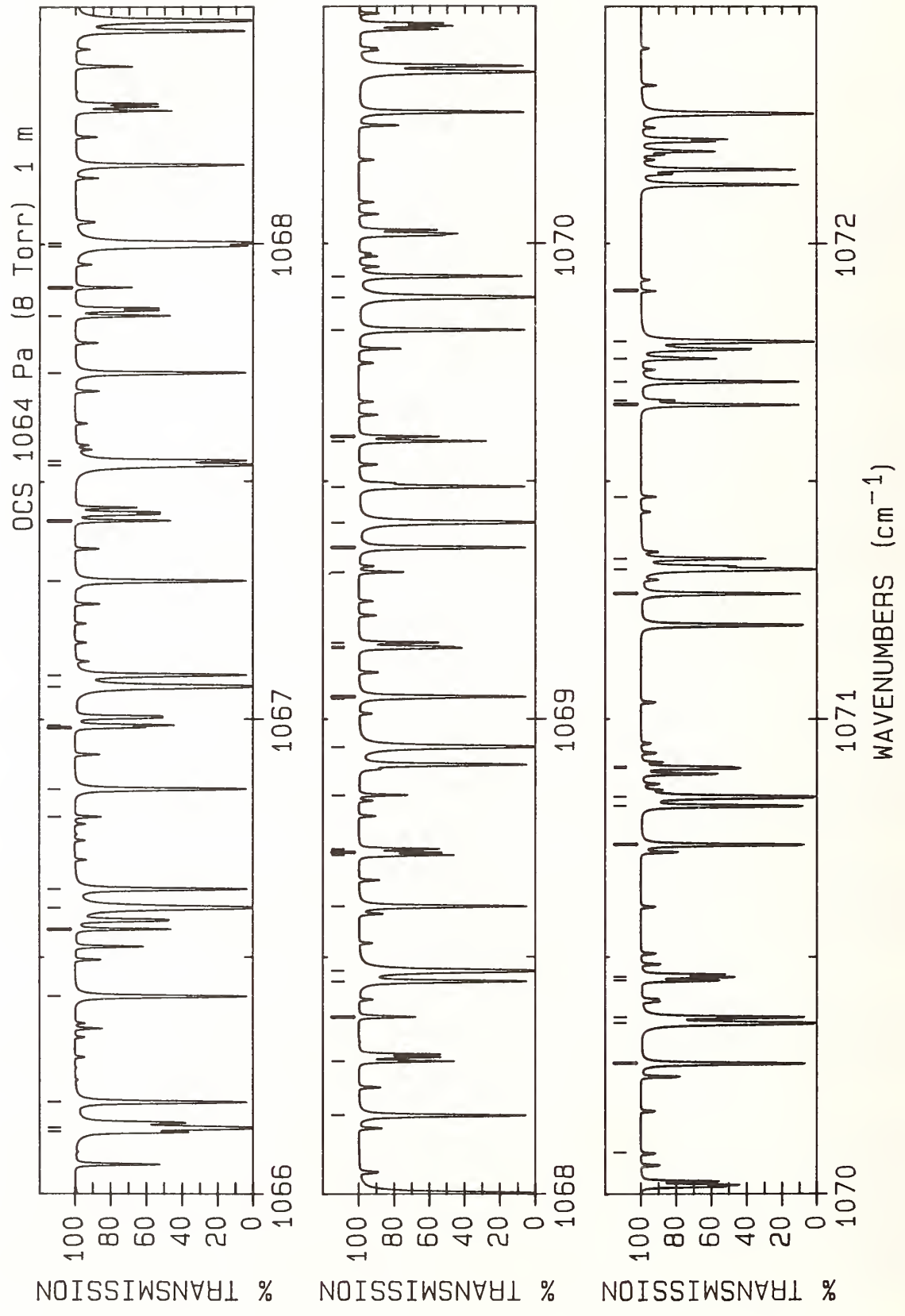

LINE #	WAVENUMBER(unc) (cm ⁻¹)	LOWER STATE (cm ⁻¹)	INTENSITY (cm/molecule)	ASSIGNMENT ROTATION BAND	LINE #	WAVENUMBER(unc) (cm ⁻¹)	LOWER STATE (cm ⁻¹)	INTENSITY (cm/molecule)	ASSIGNMENT ROTATION BAND
1	1066.131 40(9)*	1124.36	0.123E-21	R(19) G	36	1069.148 87(9)*	1189.87	0.122E-21	R(26) G
2	1066.140 805(14)*	383.65	0.256E-20	R(43) A	37	1069.151 92(7)	1173.59	0.950E-22	R(25) E
3	1066.195 19(6)*	709.47	0.727E-21	R(30) C	38	1069.160 23(7)	1173.59	0.950E-22	R(25) F
4	1066.418 02(6)*	721.86	0.708E-21	R(31) B	39	1069.308 83(25)	609.13	0.467E-22	R(55) P
5	1066.559 27(9)*	1132.50	0.124E-21	R(20) G	40	1069.360 34(6)*	806.20	0.566E-21	R(37) C
6	1066.604 170(14)*	401.49	0.240E-20	R(44) A	41	1069.413 498(15)*	517.00	0.155E-20	R(50) A
7	1066.643 44(6)*	722.07	0.708E-21	R(31) C	42	1069.488 43(6)*	821.33	0.540E-21	R(38) B
8	1066.795 81(11)	798.44	0.253E-22	R(37) R	43	1069.584 13(7)	1184.17	0.939E-22	R(26) E
9	1066.853 92(6)*	734.85	0.687E-21	R(32) B	44	1069.584 27(9)*	1200.85	0.121E-21	R(27) G
10	1066.983 64(24)	504.37	0.709E-22	R(50) P	45	1069.593 77(7)	1184.17	0.939E-22	R(26) F
11	1066.988 20(9)*	1141.04	0.125E-21	R(21) G	46	1069.817 74(6)*	821.64	0.540E-21	R(38) C
12	1067.068 910(14)*	419.73	0.224E-20	R(45) A	47	1069.886 643(15)*	537.67	0.143E-20	R(51) A
13	1067.092 99(6)*	735.07	0.687E-21	R(32) C	48	1069.930 72(6)*	837.16	0.514E-21	R(39) B
14	1067.290 73(6)*	748.25	0.665E-21	R(33) B	49	1070.087 17(18)	1642.98	0.141E-22	R(18) L
15	1067.418 18(9)*	1149.99	0.125E-21	R(22) G	50	1070.276 45(6)*	837.49	0.514E-21	R(39) C
16	1067.535 033(14)*	438.37	0.209E-20	R(46) A	51	1070.361 216(15)*	558.74	0.131E-20	R(52) A
17	1067.543 85(6)*	748.49	0.664E-21	R(33) C	52	1070.373 92(6)*	853.39	0.488E-21	R(40) B
18	1067.728 45(6)*	762.05	0.641E-21	R(34) B	53	1070.451 04(7)	1206.55	0.909E-22	R(28) E
19	1067.849 23(9)*	1159.35	0.125E-21	R(23) G	54	1070.458 44(9)*	1224.04	0.116E-21	R(29) G
20	1067.909 48(24)	545.09	0.604E-22	R(52) P	55	1070.736 47(6)*	853.74	0.488E-21	R(40) C
21	1067.996 01(6)*	762.31	0.641E-21	R(34) C	56	1070.818 05(6)*	870.04	0.462E-21	R(41) B
22	1068.002 547(14)*	457.42	0.195E-20	R(47) A	57	1070.837 222(16)*	580.22	0.120E-20	R(53) A
23	1068.167 07(6)*	776.26	0.617E-21	R(35) B	58	1070.897 23(9)*	1236.25	0.113E-21	R(30) G
24	1068.281 35(9)*	1169.12	0.125E-21	R(24) G	59	1070.900 27(7)	1218.36	0.891E-22	R(29) F
25	1068.374 51(24)	566.04	0.555E-22	R(53) P	60	1071.263 10(6)*	887.08	0.437E-21	R(42) B
26	1068.449 48(6)*	776.53	0.616E-21	R(35) C	61	1071.314 671(16)*	602.10	0.110E-20	R(54) A
27	1068.471 457(15)*	476.88	0.181E-20	R(48) A	62	1071.337 16(9)*	1248.86	0.110E-21	R(31) G
28	1068.606 61(6)*	790.88	0.592E-21	R(36) B	63	1071.337 74(7)	1230.57	0.870E-22	R(30) F
29	1068.714 56(9)*	1179.29	0.124E-21	R(25) G	64	1071.467 34(17)	1667.59	0.146E-22	R(21) M
30	1068.720 54(7)	1163.41	0.957E-22	R(24) E	65	1071.660 46(6)*	887.47	0.436E-21	R(42) C
31	1068.727 67(7)	1163.41	0.957E-22	R(24) F	66	1071.669 87(26)	723.75	0.290E-22	R(60) P
32	1068.840 96(25)	587.39	0.510E-22	R(54) P	67	1071.709 08(6)*	904.54	0.411E-21	R(43) B
33	1068.941 772(15)*	496.74	0.167E-20	R(49) A	68	1071.757 41(7)	1243.17	0.846E-22	R(31) E
34	1069.043 11(11)	877.73	0.197E-22	R(42) R	69	1071.793 571(17)*	624.39	0.101E-20	R(55) A
35	1069.047 06(6)*	805.90	0.566E-21	R(37) B	70	1071.899 83(17)	1676.56	0.146E-22	R(22) M

OCS 800 Pa (6 Torr) 2 m

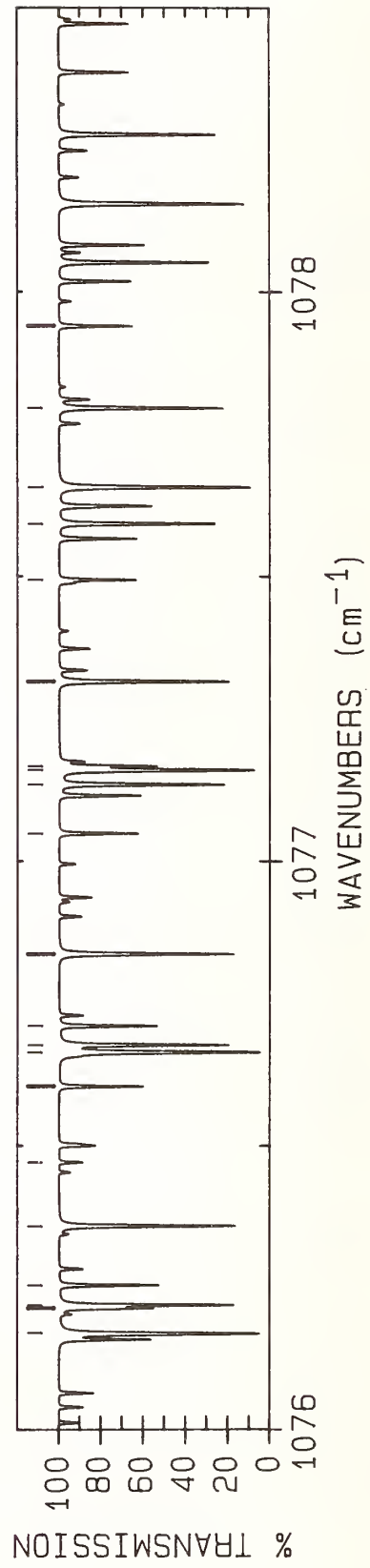
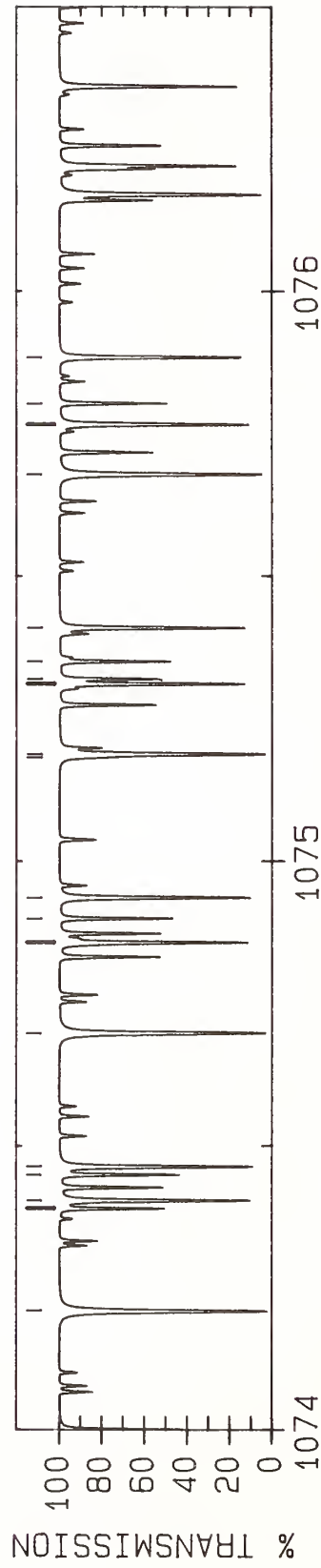
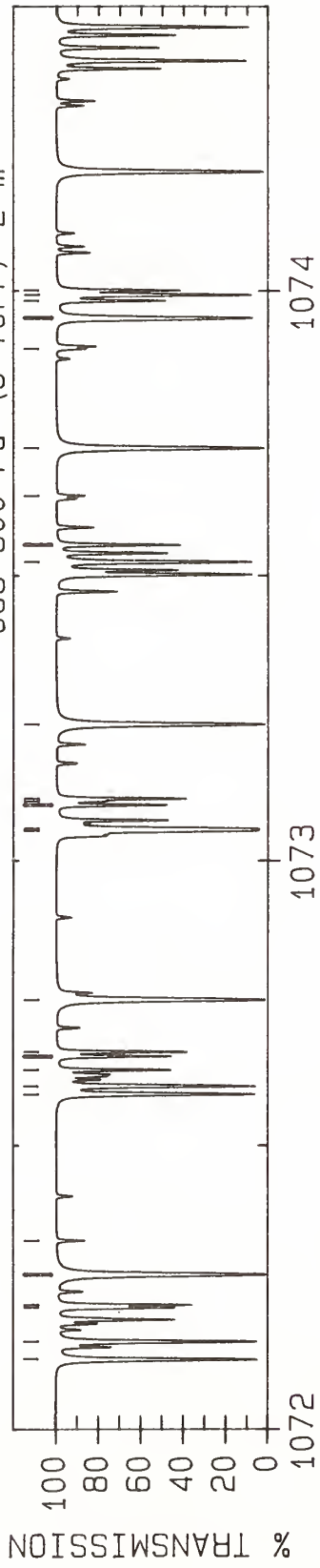

LINE #	WAVENUMBER(cm ⁻¹)	LOWER STATE (cm ⁻¹)	INTENSITY (cm/molecule)	ASSIGNMENT ROTATION BAND	LINE #	WAVENUMBER(cm ⁻¹)	LOWER STATE (cm ⁻¹)	INTENSITY (cm/molecule)	ASSIGNMENT ROTATION BAND
1	1072.124 43(6)*	904.94	0.411E-21	R(43) C	36	1074.899 43(9)*	1364.38	0.796E-22	R(39) G
2	1072.155 99(6)*	922.39	0.387E-21	R(44) B	37	1074.935 98(6)*	1018.28	0.272E-21	R(49) C
3	1072.215 62(8)	1256.20	0.821E-22	R(32) F	38	1075.181 65(22)	1762.64	0.132E-22	R(30) L
4	1072.220 52(9)*	1275.30	0.103E-21	R(33) G	39	1075.187 160(21)*	791.70	0.500E-21	R(62) A
5	1072.273 929(17)*	647.08	0.917E-21	R(56) A	40	1075.310 64(6)*	1058.74	0.234E-21	R(51) B
6	1072.333 39(16)	1685.94	0.146E-22	R(23) M	41	1075.319 36(19)	1358.74	0.615E-22	R(39) F
7	1072.589 72(6)*	922.82	0.386E-21	R(44) C	42	1075.350 26(9)*	1380.65	0.755E-22	R(40) G
8	1072.603 83(6)*	940.66	0.362E-21	R(45) B	43	1075.409 21(6)*	1038.59	0.252E-21	R(50) C
9	1072.632 19(8)	1269.62	0.794E-22	R(33) E	44	1075.677 956(22)*	817.21	0.448E-21	R(63) A
10	1072.656 04(9)	1269.63	0.795E-22	R(33) F	45	1075.765 10(6)*	1079.84	0.215E-21	R(52) B
11	1072.663 97(9)*	1289.13	0.995E-22	R(34) G	46	1075.766 73(21)	1375.01	0.584E-22	R(40) F
12	1072.755 753(18)*	670.17	0.833E-21	R(57) A	47	1075.802 37(9)*	1397.33	0.714E-22	R(41) G
13	1073.052 61(6)*	959.33	0.339E-21	R(46) B	48	1075.883 76(6)*	1059.31	0.233E-21	R(51) C
14	1073.056 33(6)*	941.10	0.362E-21	R(45) C	49	1076.170 278(23)*	843.13	0.401E-21	R(64) A
15	1073.097 45(10)	1283.47	0.767E-22	R(34) F	50	1076.215 10(24)	1391.69	0.552E-22	R(41) F
16	1073.104 10(27)	797.25	0.212E-22	R(63) P	51	1076.220 51(6)*	1101.34	0.198E-21	R(53) B
17	1073.108 61(9)*	1303.37	0.957E-22	R(35) G	52	1076.255 78(9)*	1414.41	0.674E-22	R(42) G
18	1073.239 052(18)*	693.67	0.756E-21	R(58) A	53	1076.359 65(6)*	1080.42	0.215E-21	R(52) C
19	1073.524 25(6)*	959.78	0.338E-21	R(46) C	54	1076.471 37(32)	1801.70	0.121E-22	R(33) L
20	1073.554 47(9)*	1318.01	0.917E-22	R(36) G	55	1076.604 02(23)	1408.75	0.521E-22	R(42) E
21	1073.640 58(15)	1716.53	0.143E-22	R(26) M	56	1076.664 132(25)*	869.46	0.358E-21	R(65) A
22	1073.723 834(19)*	717.57	0.684E-21	R(59) A	57	1076.664 47(26)	1408.78	0.522E-22	R(42) F
23	1073.898 48(18)	1727.23	0.141E-22	R(27) L	58	1076.676 90(6)*	1123.25	0.181E-21	R(54) B
24	1073.949 91(10)	1312.34	0.707E-22	R(36) E	59	1076.710 49(9)*	1431.90	0.635E-22	R(43) G
25	1073.952 98(6)*	997.88	0.294E-21	R(48) B	60	1076.836 87(6)*	1101.95	0.197E-21	R(53) C
26	1073.983 24(13)	1312.36	0.707E-22	R(36) F	61	1077.048 62(26)	1426.24	0.491E-22	R(43) E
27	1073.993 50(6)*	978.88	0.315E-21	R(47) C	62	1077.134 25(6)*	1145.56	0.166E-21	R(55) B
28	1074.001 55(9)*	1333.06	0.877E-22	R(37) G	63	1077.159 528(26)*	896.18	0.318E-21	R(66) A
29	1074.210 107(20)*	741.87	0.617E-21	R(60) A	64	1077.166 52(9)*	1449.79	0.596E-22	R(44) G
30	1074.390 58(11)	1327.39	0.677E-22	R(37) E	65	1077.315 43(6)*	1123.88	0.181E-21	R(54) C
31	1074.404 58(6)*	1017.76	0.273E-21	R(49) B	66	1077.493 83(31)	1444.14	0.461E-22	R(44) E
32	1074.449 87(9)*	1348.52	0.837E-22	R(38) G	67	1077.592 57(7)*	1168.28	0.152E-21	R(56) B
33	1074.464 08(6)*	998.38	0.294E-21	R(48) C	68	1077.656 473(27)*	923.31	0.283E-21	R(67) A
34	1074.697 879(21)*	766.58	0.556E-21	R(61) A	69	1077.795 32(6)*	1146.22	0.166E-21	R(55) C
35	1074.857 13(6)*	1038.05	0.253E-21	R(50) B	70	1077.939 63(36)	1462.44	0.432E-22	R(45) E

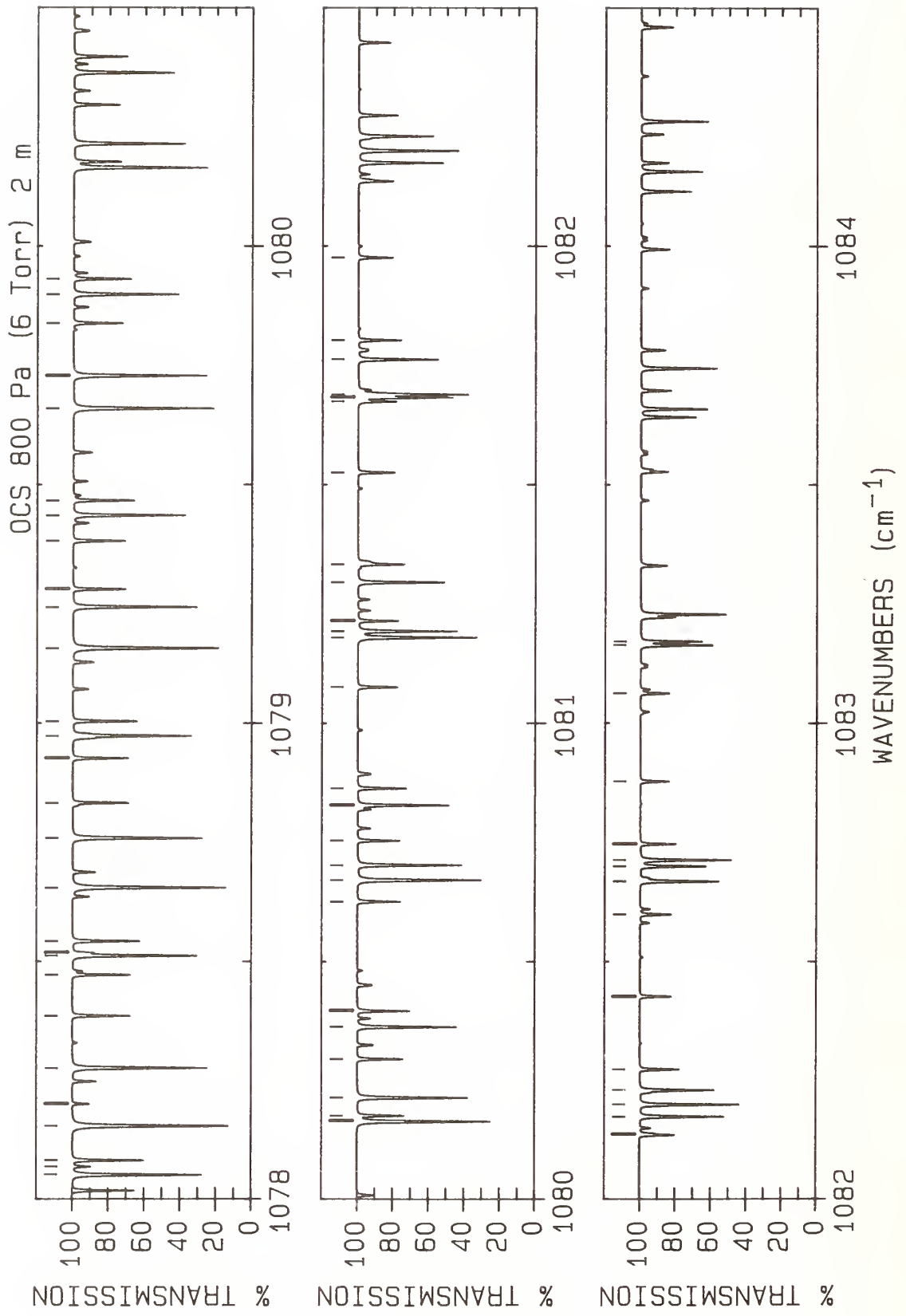

LINE #	WAVENUMBER(unc) (cm ⁻¹)	LOWER STATE (cm ⁻¹)	INTENSITY (cm/molecule)	ASSIGNMENT ROTATION BAND	LINE #	WAVENUMBER(unc) (cm ⁻¹)	LOWER STATE (cm ⁻¹)	INTENSITY (cm/molecule)	ASSIGNMENT ROTATION BAND
1	1078.051 87(7)*	1191.40	0.138E-21	R(57) B	36	1080.625 94(86)	1580.76	0.278E-22	R(51) E
2	1078.069 18(34)	1844.98	0.107E-22	R(36) M	37	1080.671 144(38)*	1094.57	0.133E-21	R(73) A
3	1078.082 59(9)*	1486.80	0.522E-22	R(46) G	38	1080.702 81(6)*	1288.73	0.929E-22	R(61) C
4	1078.154 976(29)*	950.85	0.251E-21	R(68) A	39	1080.754 29(66)	1580.82	0.279E-22	R(51) F
5	1078.201 41(51)	1859.48	0.103E-22	R(37) L	40	1080.828 52(7)*	1338.62	0.754E-22	R(63) B
6	1078.276 54(6)*	1168.96	0.151E-21	R(56) C	41	1080.863 96(9)*	1607.56	0.330E-22	R(52) G
7	1078.386 00(42)	1481.14	0.404E-22	R(46) E	42	1081.075 44(98)	1601.90	0.256E-22	R(52) E
8	1078.472 01(41)	1481.18	0.404E-22	R(46) F	43	1081.179 163(40)*	1124.52	0.116E-21	R(74) A
9	1078.512 16(7)*	1214.93	0.126E-21	R(58) B	44	1081.192 10(6)*	1313.90	0.837E-22	R(62) C
10	1078.518 15(39)	1860.07	0.102E-22	R(37) M	45	1081.213 82(72)	1601.96	0.257E-22	R(52) F
11	1078.542 67(9)*	1505.91	0.486E-22	R(47) G	46	1081.294 82(8)*	1364.57	0.676E-22	R(64) B
12	1078.655 046(30)*	978.78	0.222E-21	R(69) A	47	1081.332 50(9)*	1629.11	0.303E-22	R(53) G
13	1078.759 11(6)*	1192.10	0.138E-21	R(57) C	48	1081.525 4	1623.45	0.236E-22	R(53) E
14	1078.832 93(49)	1500.26	0.377E-22	R(47) E	49	1081.674 39(78)	1623.51	0.236E-22	R(53) F
15	1078.926 43(45)	1500.30	0.377E-22	R(47) F	50	1081.682 74(6)*	1339.47	0.753E-22	R(63) C
16	1078.973 43(7)*	1238.86	0.114E-21	R(59) B	51	1081.688 795(43)*	1154.87	0.101E-21	R(75) A
17	1079.004 12(9)*	1525.43	0.452E-22	R(48) G	52	1081.762 14(8)*	1390.93	0.605E-22	R(65) B
18	1079.156 689(32)*	1007.13	0.196E-21	R(70) A	53	1081.802 48(9)*	1651.06	0.278E-22	R(54) G
19	1079.243 02(6)*	1215.65	0.125E-21	R(58) C	54	1081.975 9	1645.40	0.216E-22	R(54) E
20	1079.280 40(56)	1519.78	0.351E-22	R(48) E	55	1082.135 98(85)	1645.47	0.217E-22	R(54) F
21	1079.381 86(49)	1519.82	0.351E-22	R(48) F	56	1082.174 74(6)*	1365.45	0.675E-22	R(64) C
22	1079.435 70(7)*	1263.19	0.103E-21	R(60) B	57	1082.200 047(46)*	1185.63	0.882E-22	R(76) A
23	1079.466 96(9)*	1545.35	0.419E-22	R(49) G	58	1082.230 50(8)*	1417.69	0.540E-22	R(66) B
24	1079.659 915(34)*	1035.87	0.172E-21	R(71) A	59	1082.273 94(9)*	1673.42	0.254E-22	R(55) G
25	1079.728 27(6)*	1239.61	0.114E-21	R(59) C	60	1082.426 7	1667.76	0.198E-22	R(55) E
26	1079.728 40(65)	1539.70	0.325E-22	R(49) E	61	1082.598 62(93)	1667.83	0.198E-22	R(55) F
27	1079.838 31(54)	1539.75	0.326E-22	R(49) F	62	1082.668 09(6)*	1391.83	0.604E-22	R(65) C
28	1079.898 97(7)*	1287.93	0.931E-22	R(61) B	63	1082.699 89(9)*	1444.85	0.481E-22	R(67) B
29	1079.931 21(9)*	1565.68	0.388E-22	R(50) G	64	1082.712 927(49)*	1216.79	0.766E-22	R(77) A
30	1080.164 731(36)*	1065.02	0.151E-21	R(72) A	65	1082.746 87(9)*	1696.18	0.232E-22	R(56) G
31	1080.176 92(75)	1560.03	0.301E-22	R(50) E	66	1082.878 0	1690.52	0.181E-22	R(56) E
32	1080.214 87(6)*	1263.97	0.103E-21	R(60) C	67	1083.062 3	1690.60	0.181E-22	R(56) F
33	1080.295 79(60)	1560.08	0.302E-22	R(50) F	68	1083.162 79(7)*	1418.62	0.539E-22	R(66) C
34	1080.363 24(7)*	1313.07	0.839E-22	R(62) B	69	1083.170 33(9)*	1472.41	0.428E-22	R(68) B
35	1080.396 87(9)*	1586.42	0.358E-22	R(51) G					

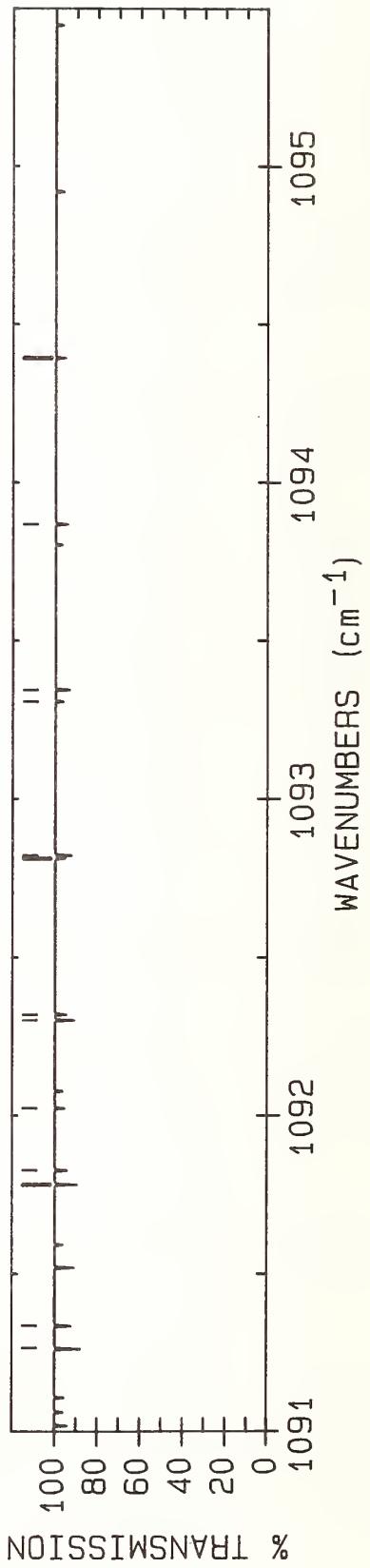
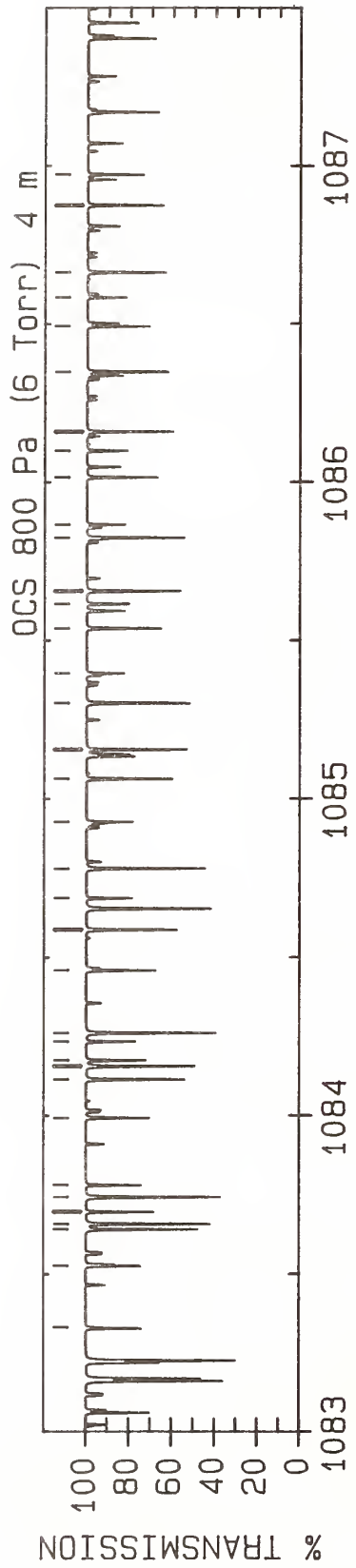

LINE #	WAVENUMBER(cm ⁻¹)	LOWER STATE (cm ⁻¹)	INTENSITY (cm/molecule)	ASSIGNMENT ROTATION BAND	LINE #	WAVENUMBER(unc)(cm ⁻¹)	LOWER STATE (cm ⁻¹)	INTENSITY (cm/molecule)	ASSIGNMENT ROTATION BAND
1	1083.329 8	1713.69	0.165E-22	R(57) E	36	1086.972 45(17)	1707.48	0.154E-22	R(76) B
2	1083.527 0	1713.77	0.165E-22	R(57) F	37	1087.169 48(11)*	1647.46	0.201E-22	R(74) C
3	1083.641 82(10)*	1500.39	0.379E-22	R(69) B	38	1087.403 138(96)*	1515.34	0.196E-22	R(86) A
4	1083.658 85(7)*	1445.81	0.480E-22	R(67) C	39	1087.452 68(19)	1738.67	0.134E-22	R(77) B
5	1083.697 20(10)*	1742.93	0.191E-22	R(58) G	40	1087.676 48(13)*	1677.89	0.176E-22	R(75) C
6	1083.743 595(56)*	1280.32	0.575E-22	R(79) A	41	1088.184 85(14)*	1708.71	0.154E-22	R(76) C
7	1083.781 9	1737.26	0.150E-22	R(58) E	42	1088.416 55(23)	1802.28	0.101E-22	R(79) B
8	1083.992 8	1737.35	0.150E-22	R(58) F	43	1088.463 82(11) *	1586.11	0.141E-22	R(88) A
9	1084.114 38(10)*	1528.76	0.336E-22	R(70) B	44	1088.694 60(16)	1739.94	0.134E-22	R(77) C
10	1084.156 28(7)*	1473.41	0.427E-22	R(68) C	45	1088.996 69(12) *	1622.10	0.120E-22	R(89) A
11	1084.174 61(10)*	1766.91	0.173E-22	R(59) G	46	1089.205 73(17)	1771.58	0.117E-22	R(78) C
12	1084.234 4	1761.24	0.136E-22	R(59) E	47	1089.531 27(13) *	1658.48	0.101E-22	R(90) A
13	1084.261 397(61)*	1312.69	0.496E-22	R(80) A	48	1089.718 23(19)	1803.61	0.101E-22	R(79) C
14	1084.459 7	1761.33	0.136E-22	R(59) F	49	1089.871 06(30)	1900.71	0.653E-23	R(82) B
15	1084.588 00(11)*	1557.54	0.296E-22	R(71) B	50	1090.023 40(24)	2086.28	0.444E-23	R(71) G
16	1084.687 3	1785.62	0.123E-22	R(60) E	51	1090.232 12(21)	1836.05	0.878E-23	R(80) C
17	1084.780 853(65)*	1345.46	0.427E-22	R(81) A	52	1090.358 26(33)	1934.32	0.561E-23	R(83) B
18	1084.927 6	1785.72	0.123E-22	R(60) F	53	1090.520 87(27)	2115.53	0.391E-23	R(72) G
19	1085.062 70(12)*	1586.72	0.261E-22	R(72) B	54	1090.626 9	2109.97	0.311E-23	R(72) F
20	1085.155 21(8)*	1529.81	0.335E-22	R(70) C	55	1090.747 40(24)	1868.90	0.759E-23	R(81) C
21	1085.301 969(70)*	1378.63	0.367E-22	R(82) A	56	1090.846 67(36)	1968.34	0.482E-23	R(84) B
22	1085.396 5	1810.52	0.111E-22	R(61) F	57	1091.019 89(30)	2145.18	0.343E-23	R(73) G
23	1085.538 48(13)*	1616.30	0.230E-22	R(73) B	58	1091.264 06(26)	1902.14	0.655E-23	R(82) C
24	1085.615 99(11)*	1841.28	0.127E-22	R(62) G	59	1091.336 30(39)	2002.76	0.413E-23	R(85) B
25	1085.656 73(9)*	1558.62	0.296E-22	R(71) C	60	1091.782 10(29)	1935.79	0.564E-23	R(83) C
26	1085.824 750(76)*	1412.21	0.315E-22	R(83) A	61	1091.827 16(43)	2037.58	0.353E-23	R(86) B
27	1085.866 6	1835.71	0.100E-22	R(62) F	62	1092.022 57(39)	2205.70	0.263E-23	R(75) G
28	1086.015 36(14)*	1646.29	0.201E-22	R(74) B	63	1092.301 54(32)	1969.85	0.484E-23	R(84) C
29	1086.099 51(11)*	1866.88	0.114E-22	R(63) G	64	1092.319 26(47)	2072.80	0.301E-23	R(87) B
30	1086.159 61(10)*	1587.83	0.261E-22	R(72) C	65	1092.812 62(51)	2108.43	0.256E-23	R(88) B
31	1086.349 202(82)*	1446.18	0.270E-22	R(84) A	66	1092.822 36(35)	2004.30	0.415E-23	R(85) C
32	1086.493 35(16)	1676.68	0.176E-22	R(75) B	67	1093.307 26(55)	2144.46	0.217E-23	R(89) B
33	1086.584 57(12)*	1892.89	0.102E-22	R(64) G	68	1093.344 58(39)	2039.16	0.355E-23	R(86) C
34	1086.663 86(10)*	1617.44	0.230E-22	R(73) C	69	1093.868 19(42)	2074.42	0.303E-23	R(87) C
35	1086.875 329(89)*	1480.56	0.230E-22	R(85) A	70	1094.393 19(46)	2110.08	0.258E-23	R(88) C



ATLAS OF OCS ABSORPTION LINES FROM 1650 cm⁻¹ to 1739 cm⁻¹

key:

Band	Isotopomer	Vibrational Transition
A	¹⁶ O ¹² C ³² S	00 ⁰ 2-00 ⁰ 0
B		01 ¹ 2-01 ^{1e} 0
C		01 ¹ 2-01 ^{1f} 0
D		00 ⁰ 3-00 ⁰ 1
E		02 ² 2-02 ^{2e} 0
F		02 ² 2-02 ^{2f} 0
G		02 ⁰ 2-02 ⁰ 0
H		01 ¹ 3-01 ^{1e} 1
I		01 ¹ 3-01 ^{1f} 1
L	¹⁶ O ¹² C ³³ S	00 ⁰ 2-00 ⁰ 0
P	¹⁶ O ¹² C ³⁴ S	00 ⁰ 2-00 ⁰ 0
Q		01 ¹ 2-01 ^{1e} 0
R		01 ¹ 2-01 ^{1f} 0
T	¹⁶ O ¹³ C ³² S	00 ⁰ 2-00 ⁰ 0

If the e or f designation is not specified (for $l \neq 0$), then the transition is to either level, depending on the selection rules and the change in the rotational quantum number, J . Spectra are given for a slitwidth of 0.003 cm⁻¹, a temperature of 296 K, and a transition moment of 0.0195 debye. No Herman-Wallis constant was included in the intensity calculation.

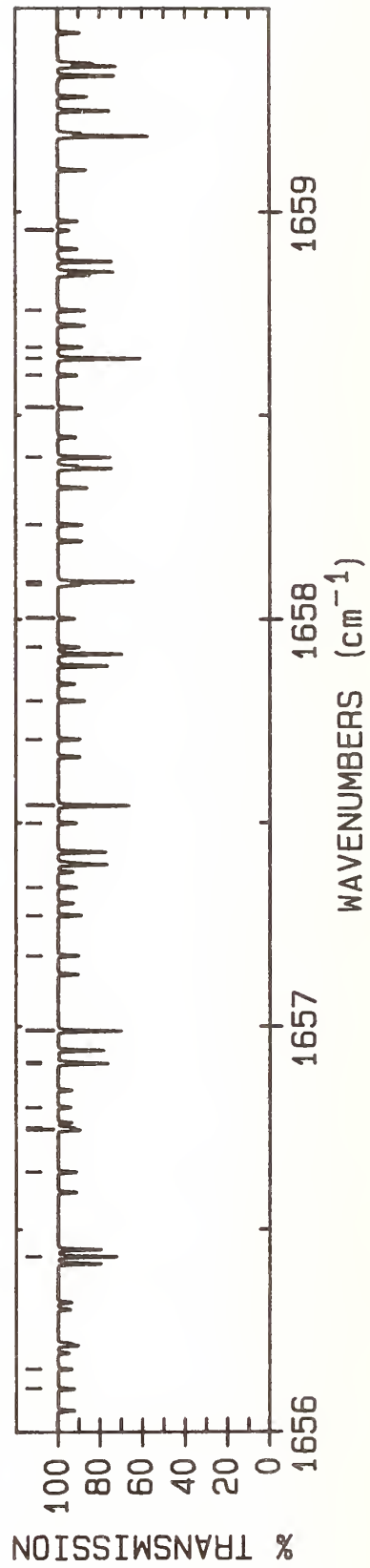
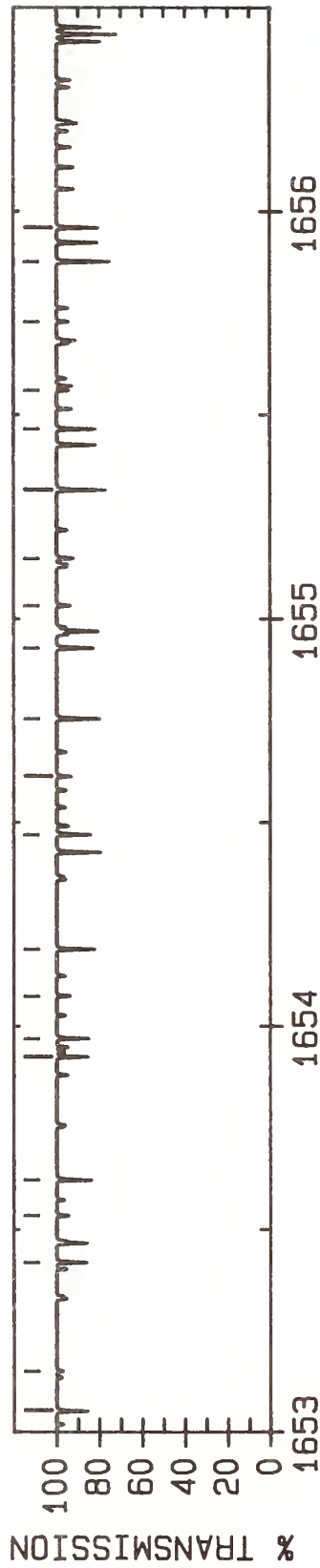
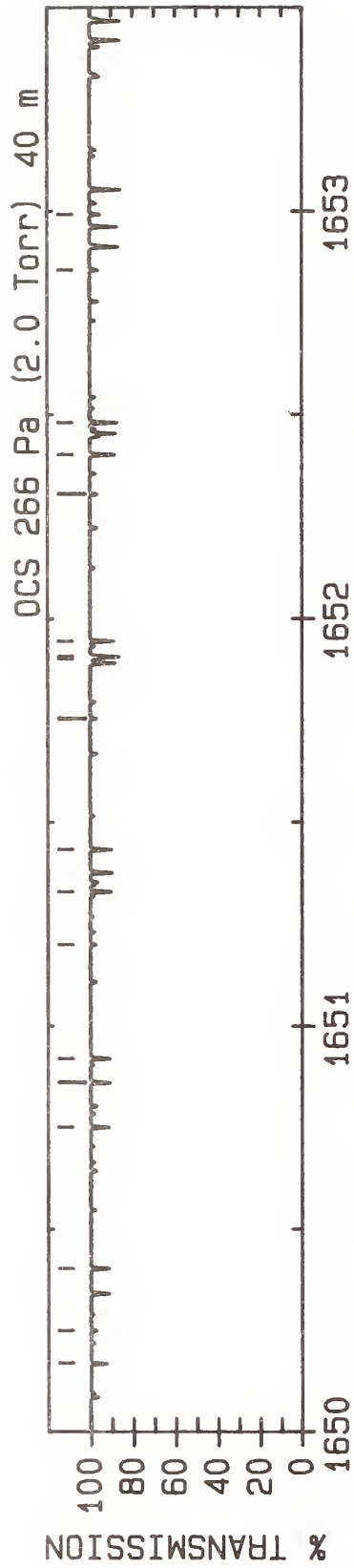

LINE #	WAVENUMBER(cm^{-1})	LOWER STATE (cm^{-1})	INTENSITY ($\text{cm}/\text{molecule}$)	ASSIGNMENT ROTATION BAND	LINE #	WAVENUMBER(unc) (cm^{-1})	LOWER STATE (cm^{-1})	INTENSITY ($\text{cm}/\text{molecule}$)	ASSIGNMENT ROTATION BAND
1	1650.169 63(29)*	1249.06	0.158E-23	P(79)	36	1655.465 69(38)	948.28	0.400E-23	P(46)
2	1650.251 12(26)	2086.28	0.563E-24	P(71)	37	1655.560 70(35)*	1968.34	0.119E-23	P(84)
3	1650.404 19(39)	1152.34	0.180E-23	P(56)	38	1655.729 17(45)	1969.85	0.118E-23	P(84)
4	1650.751 22(27)*	1217.87	0.182E-23	P(78)	39	1655.876 91(14)*	954.88	0.580E-23	P(69)
5	1650.860 86(39)	1129.53	0.198E-23	P(55)	40	1655.959 81(38)	930.05	0.428E-23	P(45)
6	1650.920 21(38)	1130.15	0.197E-23	P(55)	41	1656.108 05(21)	1835.71	0.167E-23	P(62)
7	1651.201 09(20)	2080.72	0.581E-24	P(71)	42	1656.157 04(33)*	1934.32	0.139E-23	P(83)
8	1651.330 38(25)*	1187.08	0.209E-23	P(77)	43	1656.434 40(13)*	927.63	0.653E-23	P(68)
9	1651.434 03(38)	1108.37	0.215E-23	P(54)	44	1656.642 46(21)	1810.52	0.186E-23	P(61)
10	1651.755 00(20)	2051.88	0.659E-24	P(70)	45	1656.745 35(25)	1766.91	0.222E-23	P(59)
11	1651.902 04(25)	2000.97	0.818E-24	P(68)	46	1656.751 01(31)*	1900.71	0.161E-23	P(82)
12	1651.907 0	2322.86	0.513E-24	P(68)	47	1656.800 93(38)*	2167.70	0.128E-23	P(80)
13	1651.907 14(23)*	1156.68	0.239E-23	P(76)	48	1656.908 72(37)	894.39	0.486E-23	P(43)
14	1651.945 65(38)	1086.97	0.234E-23	P(53)	49	1656.911 71(39)*	1902.14	0.160E-23	P(82)
15	1652.306 72(20)	2023.44	0.746E-24	P(69)	50	1656.989 48(12)*	900.76	0.733E-23	P(67)
16	1652.403 03(37)	1065.41	0.255E-23	P(52)	51	1657.174 73(21)	1785.72	0.207E-23	P(60)
17	1652.481 48(21)*	1126.67	0.273E-23	P(75)	52	1657.273 36(25)	1742.93	0.246E-23	P(58)
18	1652.856 27(20)	1995.41	0.843E-24	P(68)	53	1657.342 61(29)*	1867.49	0.187E-23	P(81)
19	1652.992 51(25)	1946.12	0.104E-23	P(66)	54	1657.499 47(37)*	1868.90	0.186E-23	P(81)
20	1653.053 40(20)*	1097.06	0.311E-23	P(74)	55	1657.542 17(11)*	874.29	0.822E-23	P(66)
21	1653.151 57(45)	2108.43	0.629E-24	P(88)	56	1657.544 2	1545.54	0.106E-24	P(87)
22	1653.419 95(36)	1024.64	0.300E-23	P(50)	57	1657.704 85(21)	1761.33	0.229E-23	P(59)
23	1653.534 70(25)	1919.30	0.117E-23	P(65)	58	1657.799 34(24)	1719.35	0.271E-23	P(57)
24	1653.622 92(18)*	1067.84	0.354E-23	P(73)	59	1657.931 84(27)*	1834.68	0.217E-23	P(80)
25	1653.925 04(37)	1004.85	0.323E-23	P(49)	60	1658.002 15(30)*	2103.56	0.171E-23	P(78)
26	1653.970 23(39)	1005.35	0.322E-23	P(49)	61	1658.084 88(34)*	1836.05	0.216E-23	P(80)
27	1654.074 88(25)	1892.89	0.130E-23	P(64)	62	1658.092 46(11)*	848.22	0.919E-23	P(65)
28	1654.190 03(17)*	1039.01	0.402E-23	P(72)	63	1658.232 84(21)	1737.35	0.253E-23	P(58)
29	1654.470 90(39)	985.93	0.347E-23	P(48)	64	1658.397 73(36)	844.83	0.576E-23	P(40)
30	1654.613 02(25)	1866.88	0.146E-23	P(63)	65	1658.518 71(25)*	1802.28	0.251E-23	P(79)
31	1654.754 73(16)*	1010.57	0.455E-23	P(71)	66	1658.598 94(27)*	2072.09	0.197E-23	P(77)
32	1654.928 53(37)	966.45	0.374E-23	P(47)	67	1658.640 34(10)*	822.54	0.103E-22	P(64)
33	1655.032 76(20)	1887.33	0.134E-23	P(64)	68	1658.667 97(32)*	1803.61	0.249E-23	P(79)
34	1655.149 14(25)	1841.28	0.163E-23	P(62)	69	1658.758 68(21)	1713.77	0.279E-23	P(57)
35	1655.317 02(15)*	982.53	0.514E-23	P(70)	70	1658.954 33(20)*	2004.02	0.118E-23	P(99)

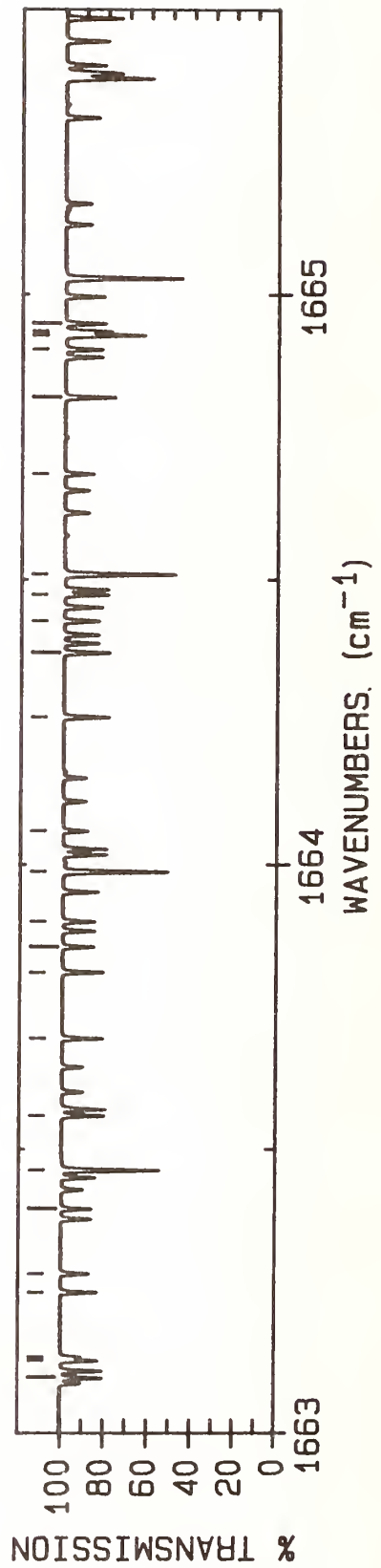
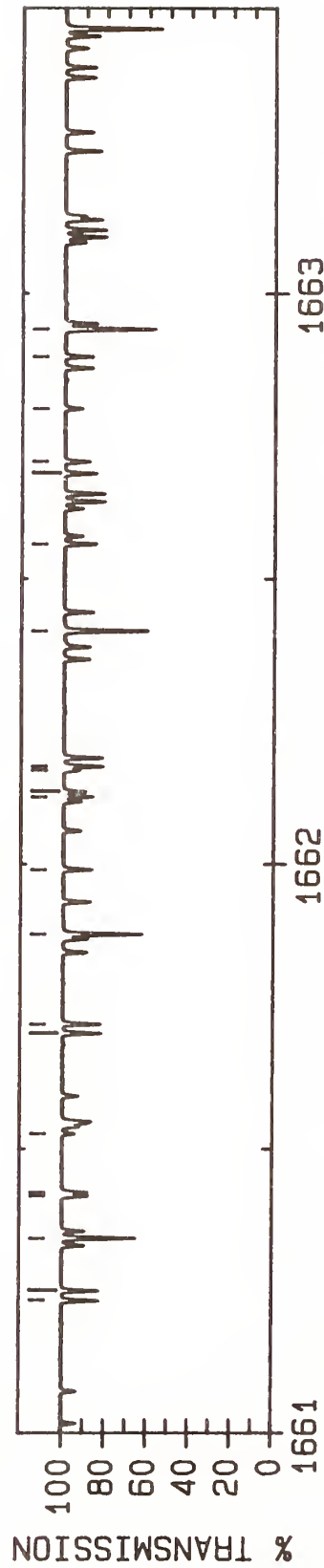
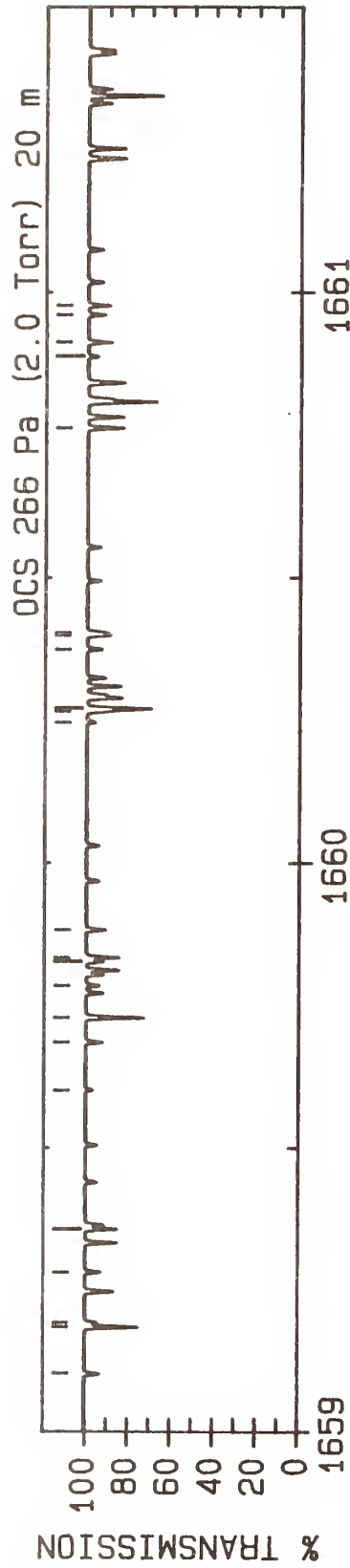

LINE #	WAVENUMBER(unc) (cm ⁻¹)	LOWER STATE (cm ⁻¹)	INTENSITY (cm/molecule)	ASSIGNMENT ROTATION BAND	LINE #	WAVENUMBER(unc) (cm ⁻¹)	LOWER STATE (cm ⁻¹)	INTENSITY (cm/molecule)	ASSIGNMENT ROTATION BAND
1	1659.103 23(24)*	1770.28	0.290E-23	P(78) B	36	1662.163 52(12)*	1808.05	0.291E-23	P(94) A
2	1659.185 84(10)*	797.25	0.114E-22	P(63) P	37	1662.170 58(33)	728.85	0.811E-23	P(32) Q
3	1659.193 19(24)*	2041.03	0.226E-23	P(76) D	38	1662.408 55(9)*	653.80	0.208E-22	P(57) P
4	1659.282 39(21)	1690.60	0.306E-23	P(56) F	39	1662.560 94(16)*	1586.72	0.654E-23	P(72) B
5	1659.357 67(35)	813.51	0.637E-23	P(38) R	40	1662.684 57(19)*	1587.83	0.650E-23	P(72) C
6	1659.601 24(18)*	1964.03	0.142E-23	P(98) A	41	1662.705 36(15)*	1863.06	0.495E-23	P(70) D
7	1659.685 38(22)*	1738.67	0.333E-23	P(77) B	42	1662.797 75(11)*	1770.05	0.346E-23	P(93) A
8	1659.728 94(9)*	772.36	0.127E-22	P(62) P	43	1662.888 90(22)	1539.75	0.559E-23	P(49) F
9	1659.784 89(22)*	2010.36	0.259E-23	P(75) D	44	1662.937 31(9)*	631.27	0.228E-22	P(56) P
10	1659.827 16(28)*	1739.94	0.331E-23	P(77) C	45	1663.098 41(32)	703.89	0.859E-23	P(30) Q
11	1659.834 38(34)	798.44	0.668E-23	P(37) R	46	1663.129 02(15)*	1557.54	0.743E-23	P(71) B
12	1659.882 92(24)	1629.11	0.391E-23	P(53) G	47	1663.134 9	1829.68	0.392E-23	P(47) I
13	1660.245 62(16)*	1924.43	0.170E-23	P(97) A	48	1663.249 13(18)*	1558.62	0.739E-23	P(71) C
14	1660.265 19(21)*	1707.48	0.383E-23	P(76) B	49	1663.281 85(14)*	1834.81	0.560E-23	P(69) D
15	1660.269 64(9)*	747.86	0.141E-22	P(61) P	50	1663.395 66(23)	1519.82	0.604E-23	P(48) F
16	1660.374 06(20)*	1980.10	0.296E-23	P(74) D	51	1663.463 68(9)*	609.13	0.249E-22	P(55) P
17	1660.398 73(24)	1607.56	0.426E-23	P(52) G	52	1663.559 00(32)	692.01	0.880E-23	P(29) Q
18	1660.403 27(26)*	1708.71	0.381E-23	P(76) C	53	1663.694 77(14)*	1528.76	0.843E-23	P(70) B
19	1660.762 19(34)	769.25	0.728E-23	P(35) Q	54	1663.811 39(17)*	1529.81	0.839E-23	P(70) C
20	1660.887 45(15)*	1885.23	0.204E-23	P(96) A	55	1663.855 82(14)*	1806.96	0.633E-23	P(68) D
21	1660.912 49(24)	1586.42	0.464E-23	P(51) G	56	1663.900 30(23)	1500.30	0.650E-23	P(47) F
22	1660.960 68(18)*	1950.24	0.338E-23	P(73) D	57	1663.987 67(9)*	587.39	0.272E-22	P(54) P
23	1660.977 06(24)*	1677.89	0.437E-23	P(75) C	58	1664.058 64(10)*	1695.27	0.487E-23	P(91) A
24	1661.233 88(34)	755.38	0.757E-23	P(34) Q	59	1664.258 19(13)*	1500.39	0.954E-23	P(69) B
25	1661.251 50(32)	755.63	0.756E-23	P(34) R	60	1664.371 36(16)*	1501.41	0.949E-23	P(69) C
26	1661.343 88(9)*	700.04	0.172E-22	P(59) P	61	1664.427 26(14)*	1779.51	0.713E-23	P(67) D
27	1661.417 75(18)*	1646.29	0.503E-23	P(74) B	62	1664.473 52(32)	669.43	0.914E-23	P(27) Q
28	1661.424 21(24)	1565.68	0.503E-23	P(50) G	63	1664.509 27(9)*	566.04	0.297E-22	P(53) P
29	1661.526 75(13)*	1846.44	0.244E-23	P(95) A	64	1664.685 30(9)*	1658.48	0.576E-23	P(90) A
30	1661.703 34(33)	741.92	0.785E-23	P(33) Q	65	1664.819 28(13)*	1472.41	0.108E-22	P(68) B
31	1661.719 54(32)	742.14	0.784E-23	P(33) R	66	1664.903 28(23)	1462.47	0.749E-23	P(45) F
32	1661.877 41(9)*	676.72	0.189E-22	P(58) P	67	1664.927 46(32)	658.73	0.927E-23	P(26) Q
33	1661.990 51(17)*	1616.30	0.574E-23	P(73) B	68	1664.929 04(15)*	1473.41	0.107E-22	P(68) C
34	1662.117 71(21)*	1617.44	0.571E-23	P(73) C	69	1664.935 20(32)	658.87	0.927E-23	P(26) R
35	1662.126 33(16)*	1891.72	0.437E-23	P(71) D	70	1664.948 84(24)	1431.90	0.831E-23	P(43) G

OCS 266 Pa (2.0 Torr) 10 m

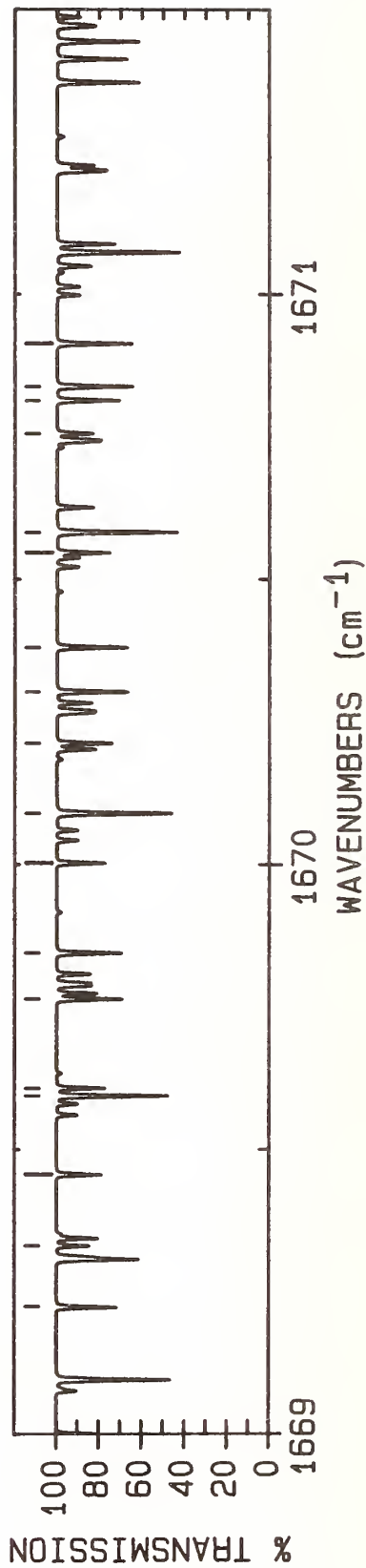
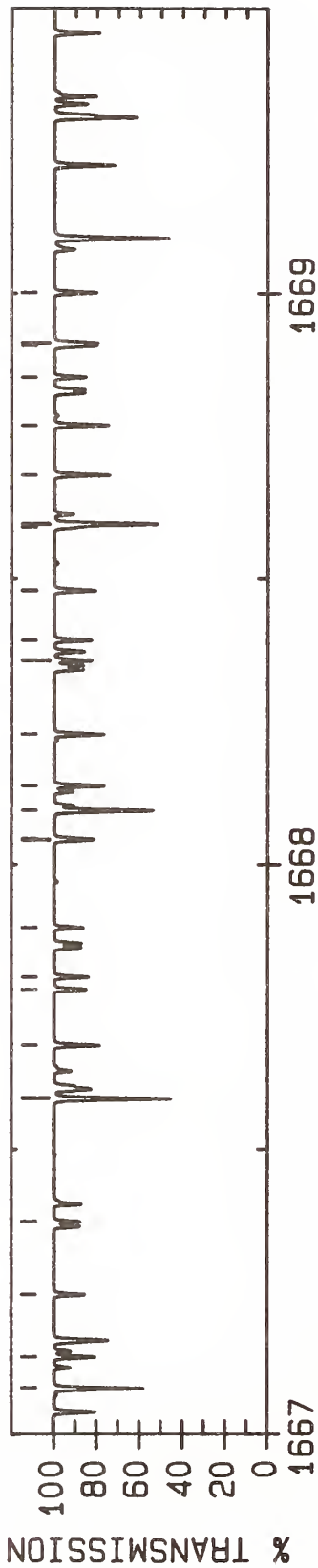
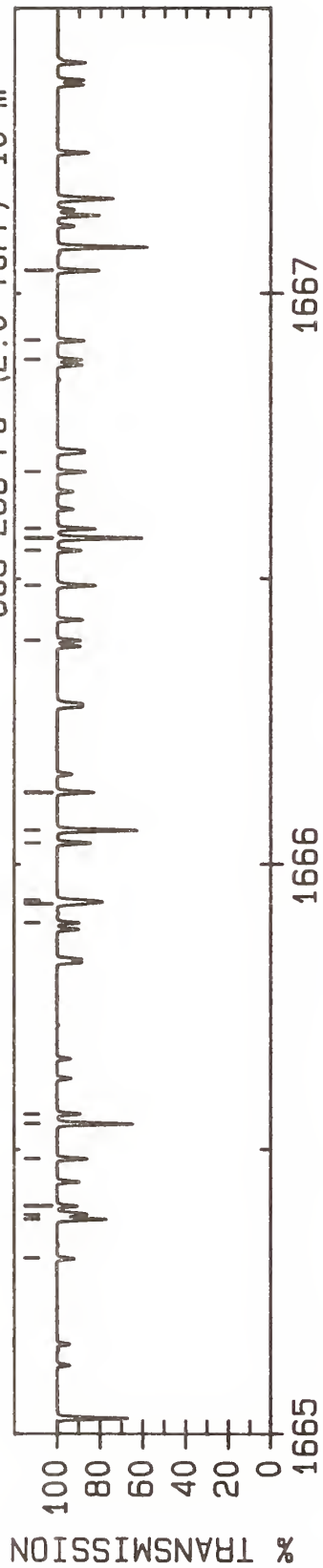

LINE #	WAVENUMBER(unc) (cm ⁻¹)	LOWER STATE (cm ⁻¹)	INTENSITY (cm/molecule)	ASSIGNMENT ROTATION BAND	LINE #	WAVENUMBER(unc) (cm ⁻¹)	LOWER STATE (cm ⁻¹)	INTENSITY (cm/molecule)	ASSIGNMENT ROTATION BAND
1	1665.309 45(9)*	1622.10	0.680E-23	P(89) A	36	1668.044 93(36)	595.02	0.924E-23	P(19) R
2	1665.378 04(12)*	1444.85	0.121E-22	P(67) B	37	1668.093 81(9)*	427.66	0.505E-22	P(46) P
3	1665.379 18(32)	648.43	0.938E-23	P(25) Q	38	1668.137 01(10)*	1313.07	0.214E-22	P(62) B
4	1665.385 93(32)	648.56	0.937E-23	P(25) R	39	1668.227 15(11)*	1313.90	0.213E-22	P(62) C
5	1665.401 62(23)	1444.17	0.800E-23	P(44) F	40	1668.356 76(13)*	1598.62	0.154E-22	P(60) D
6	1665.484 42(14)*	1445.81	0.121E-22	P(67) C	41	1668.392 43(8)*	1446.18	0.151E-22	P(84) A
7	1665.545 33(9)*	524.53	0.349E-22	P(51) P	42	1668.479 20(36)	587.41	0.909E-23	P(18) Q
8	1665.562 57(13)*	1725.81	0.898E-23	P(65) D	43	1668.480 54(37)	587.48	0.908E-23	P(18) R
9	1665.897 86(23)	1426.27	0.853E-23	P(43) F	44	1668.590 9	1642.17	0.749E-23	P(36) H
10	1665.931 07(9)*	1586.11	0.802E-23	P(88) A	45	1668.596 37(9)*	409.47	0.540E-22	P(45) P
11	1665.934 47(12)*	1417.69	0.137E-22	P(66) B	46	1668.681 86(10)*	1287.93	0.238E-22	P(61) B
12	1665.937 35(24)	1397.33	0.938E-23	P(41) G	47	1668.768 88(11)*	1288.73	0.237E-22	P(61) C
13	1666.037 53(13)*	1418.62	0.136E-22	P(66) C	48	1668.853 21(24)	1303.37	0.127E-22	P(35) G
14	1666.059 78(9)*	504.37	0.378E-22	P(50) P	49	1668.908 06(13)*	1574.38	0.171E-22	P(59) D
15	1666.125 0	1721.10	0.581E-23	P(41) H	50	1668.913 20(37)	580.28	0.888E-23	P(17) Q
16	1666.126 44(13)*	1699.57	0.100E-22	P(64) D	51	1668.913 99(38)	580.35	0.888E-23	P(17) R
17	1666.392 00(23)	1408.78	0.907E-23	P(42) F	52	1669.001 50(8)*	1412.21	0.176E-22	P(83) A
18	1666.488 58(11)*	1390.93	0.153E-22	P(65) B	53	1669.224 40(10)*	1263.19	0.264E-22	P(60) B
19	1666.550 18(8)*	1550.53	0.943E-23	P(87) A	54	1669.331 91(24)	1289.13	0.132E-22	P(34) G
20	1666.571 86(9)*	484.60	0.408E-22	P(49) P	55	1669.456 84(13)*	1550.55	0.188E-22	P(58) D
21	1666.588 35(12)*	1391.83	0.153E-22	P(65) C	56	1669.594 37(9)*	374.27	0.613E-22	P(43) P
22	1666.687 80(13)*	1673.73	0.112E-22	P(63) D	57	1669.608 07(8)*	1378.63	0.205E-22	P(82) A
23	1666.884 05(23)	1391.69	0.963E-23	P(41) F	58	1669.764 63(10)*	1238.86	0.292E-22	P(59) B
24	1666.917 60(24)	1364.38	0.105E-22	P(39) G	59	1669.845 54(10)*	1239.61	0.291E-22	P(59) C
25	1667.040 38(11)*	1364.57	0.172E-22	P(64) B	60	1670.003 12(13)*	1527.13	0.207E-22	P(57) D
26	1667.081 55(9)*	465.23	0.439E-22	P(48) P	61	1670.089 80(9)*	357.27	0.651E-22	P(42) P
27	1667.136 89(12)*	1365.45	0.171E-22	P(64) C	62	1670.212 13(8)*	1345.46	0.238E-22	P(81) A
28	1667.246 64(13)*	1648.29	0.125E-22	P(62) D	63	1670.302 55(10)*	1214.93	0.322E-22	P(58) B
29	1667.374 01(24)	1375.01	0.102E-22	P(40) F	64	1670.380 48(10)*	1215.65	0.321E-22	P(58) C
30	1667.589 85(11)*	1338.62	0.192E-22	P(63) B	65	1670.546 88(12)*	1504.10	0.228E-22	P(56) D
31	1667.683 16(11)*	1339.47	0.191E-22	P(63) C	66	1670.582 87(9)*	340.66	0.689E-22	P(41) P
32	1667.780 85(8)*	1480.56	0.129E-22	P(85) A	67	1670.755 53(24)	1248.86	0.146E-22	P(31) G
33	1667.802 96(13)*	1623.25	0.139E-22	P(61) D	68	1670.813 70(8)*	1312.69	0.276E-22	P(80) A
34	1667.889 55(24)	1333.06	0.116E-22	P(37) G	69	1670.838 18(10)*	1191.40	0.355E-22	P(57) B
35	1668.042 98(36)	594.94	0.925E-23	P(19) Q	70	1670.913 16(10)*	1192.10	0.354E-22	P(57) C

OCS 266 Pa (2.0 Torr) 5 m

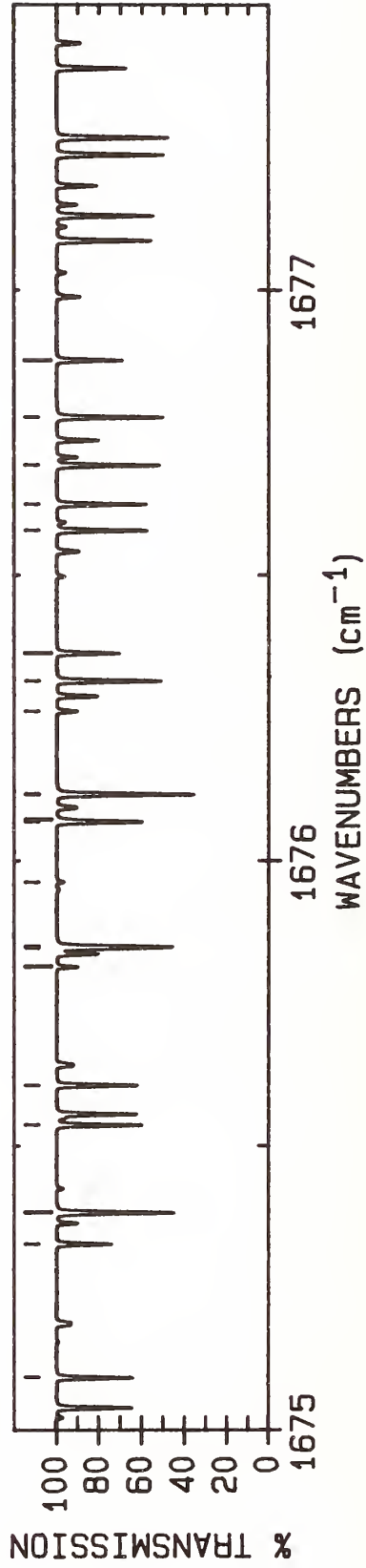
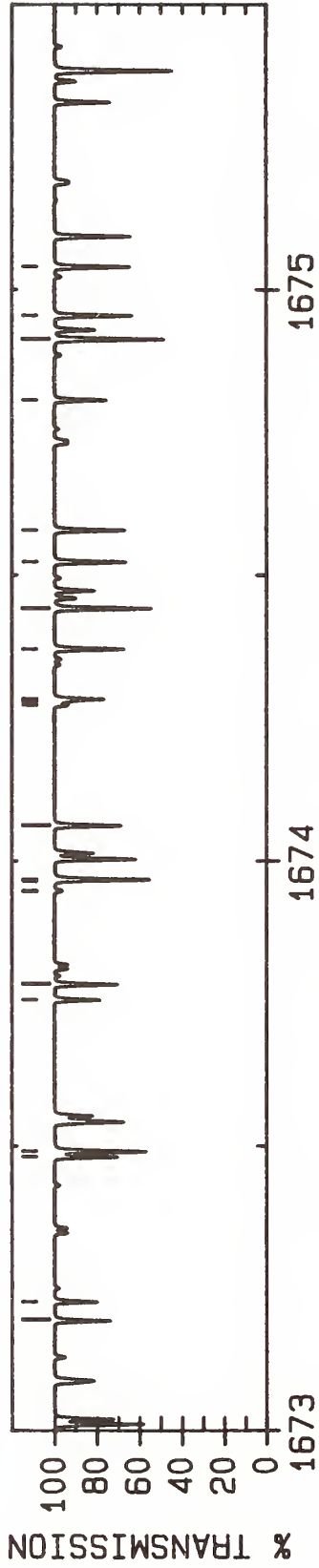
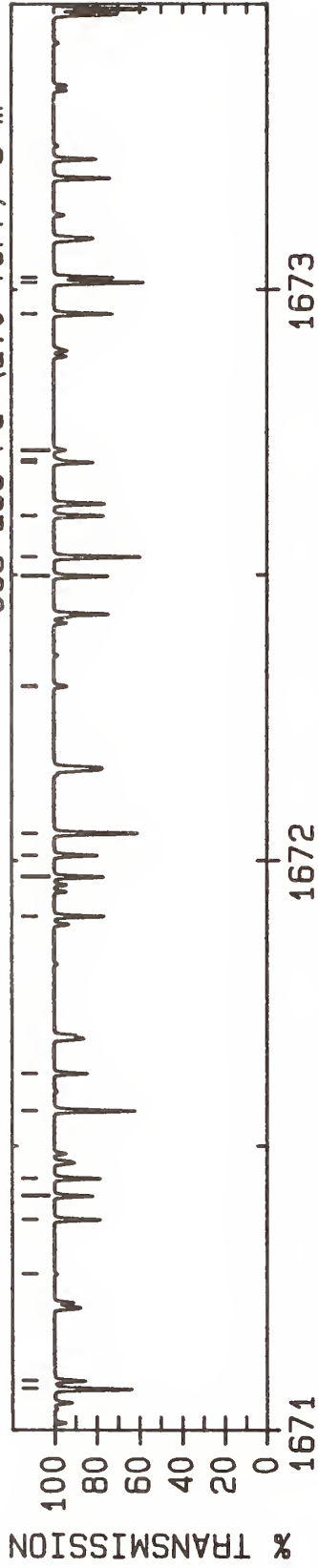

LINE #	WAVENUMBER(unc) (cm ⁻¹)	LOWER STATE (cm ⁻¹)	INTENSITY (cm/molecule)	ASSIGNMENT ROTATION BAND	LINE #	WAVENUMBER(unc) (cm ⁻¹)	LOWER STATE (cm ⁻¹)	INTENSITY (cm/molecule)	ASSIGNMENT ROTATION BAND
1	1671.073 55(9)*	324.44	0.727E-22	P(40)	36	1674.272 1	1493.97	0.103E-22	P(24)
2	1671.088 14(12)*	1481.48	0.250E-22	P(55)	37	1674.278 4	1494.11	0.103E-22	P(24)
3	1671.276 1	732.54	0.270E-23	P(60)	38	1674.283 15(12)*	1354.22	0.414E-22	P(49)
4	1671.371 50(10)*	1168.28	0.391E-22	P(56)	39	1674.370 73(8)*	1124.52	0.639E-22	P(74)
5	1671.412 77(8)*	1280.32	0.319E-22	P(79)	40	1674.441 95(9)*	221.99	0.989E-22	P(33)
6	1671.443 59(10)*	1168.96	0.389E-22	P(56)	41	1674.523 20(10)*	1038.05	0.658E-22	P(50)
7	1671.561 87(9)*	308.62	0.766E-22	P(39)	42	1674.578 96(10)*	1038.59	0.656E-22	P(50)
8	1671.626 90(12)*	1459.26	0.274E-22	P(54)	43	1674.806 90(12)*	1334.42	0.447E-22	P(48)
9	1671.902 52(10)*	1145.56	0.429E-22	P(55)	44	1674.913 35(24)	1149.99	0.168E-22	P(22)
10	1671.971 76(10)*	1146.22	0.427E-22	P(55)	45	1674.913 66(9)*	208.93	0.102E-21	P(32)
11	1672.009 34(8)*	1248.35	0.368E-22	P(78)	46	1674.954 87(8)*	1094.57	0.729E-22	P(73)
12	1672.047 81(9)*	293.19	0.805E-22	P(38)	47	1675.040 47(10)*	1017.76	0.712E-22	P(49)
13	1672.303 82(44)	537.51	0.575E-23	P(9)	48	1675.093 68(10)*	1018.28	0.710E-22	P(49)
14	1672.305 43(44)	537.49	0.575E-23	P(9)	49	1675.328 16(12)*	1315.02	0.481E-22	P(47)
15	1672.497 69(10)*	1123.88	0.468E-22	P(54)	50	1675.383 01(9)*	196.27	0.105E-21	P(31)
16	1672.531 38(9)*	278.16	0.843E-22	P(37)	51	1675.384 29(36)	1153.64	0.172E-22	P(23)
17	1672.603 42(8)*	1216.79	0.424E-22	P(77)	52	1675.384 96(24)	1153.64	0.172E-22	P(23)
18	1672.696 90(12)*	1416.04	0.325E-22	P(52)	53	1675.536 52(8)*	1065.02	0.831E-22	P(72)
19	1672.701 71(20)	764.12	0.334E-23	P(61)	54	1675.606 17(10)*	998.38	0.767E-22	P(48)
20	1672.717 82(45)	533.94	0.519E-23	P(8)	55	1675.814 20(24)	1132.50	0.167E-22	P(20)
21	1672.719 48(44)	533.92	0.519E-23	P(8)	56	1675.846 92(12)*	1296.03	0.517E-22	P(46)
22	1672.957 67(10)*	1101.34	0.512E-22	P(53)	57	1675.849 98(9)*	184.01	0.108E-21	P(30)
23	1673.012 58(9)*	263.53	0.881E-22	P(36)	58	1675.962 83(16)	622.38	0.601E-23	P(55)
24	1673.021 37(10)*	1101.95	0.511E-22	P(53)	59	1676.068 15(10)*	978.40	0.827E-22	P(47)
25	1673.195 01(8)*	1185.63	0.487E-22	P(76)	60	1676.071 67(71)	530.90	0.614E-23	P(51)
26	1673.228 15(12)*	1395.03	0.353E-22	P(51)	61	1676.115 69(8)*	1035.87	0.944E-22	P(71)
27	1673.481 81(10)*	1079.84	0.558E-22	P(52)	62	1676.116 42(10)*	978.88	0.826E-22	P(47)
28	1673.491 41(9)*	249.29	0.918E-22	P(35)	63	1676.261 46(24)	1124.36	0.165E-22	P(19)
29	1673.756 90(12)*	1374.42	0.383E-22	P(50)	64	1676.314 59(9)*	172.14	0.111E-21	P(29)
30	1673.784 12(8)*	1154.87	0.558E-22	P(75)	65	1676.363 20(12)*	1277.44	0.553E-22	P(45)
31	1673.946 86(46)	525.61	0.329E-23	P(5)	66	1676.578 56(10)*	959.33	0.889E-22	P(46)
32	1673.948 32(46)	525.60	0.329E-23	P(5)	67	1676.624 44(10)*	959.78	0.887E-22	P(46)
33	1673.964 5	616.53	0.436E-23	P(55)	68	1676.692 38(8)*	1007.13	0.107E-21	P(70)
34	1673.967 86(9)*	235.44	0.954E-22	P(34)	69	1676.776 83(9)*	160.67	0.113E-21	P(28)
35	1674.062 00(10)*	1059.31	0.605E-22	P(51)	70	1676.876 97(12)*	1259.25	0.591E-22	P(44)

OCS 266 Pa (2.0 Torr) 3 m

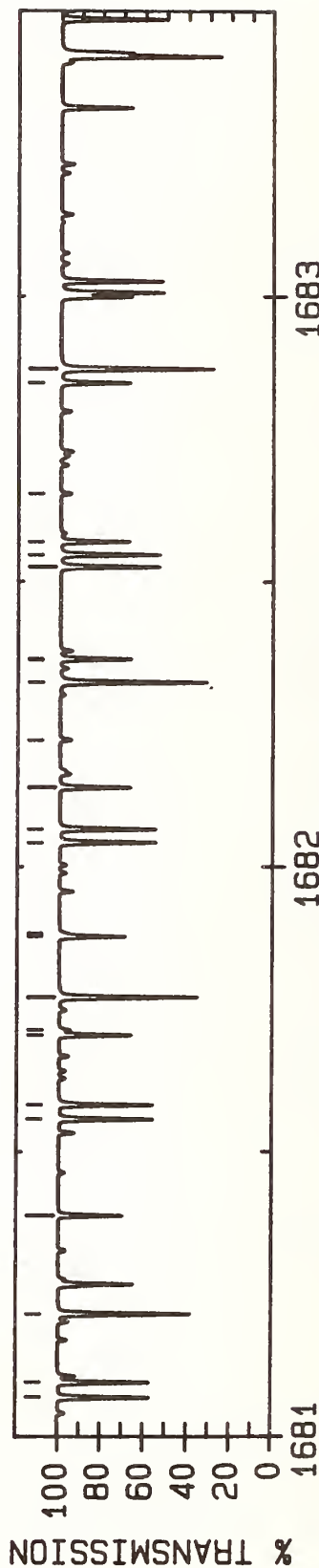
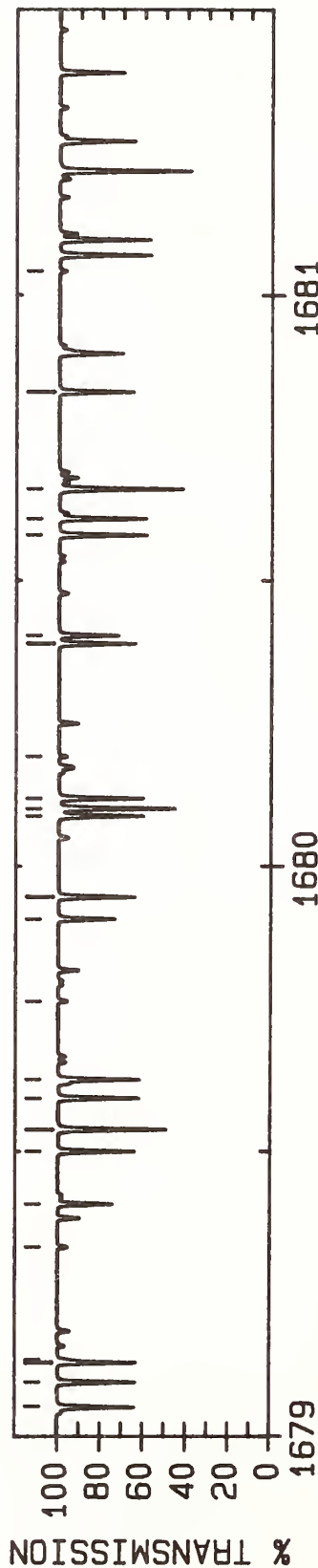
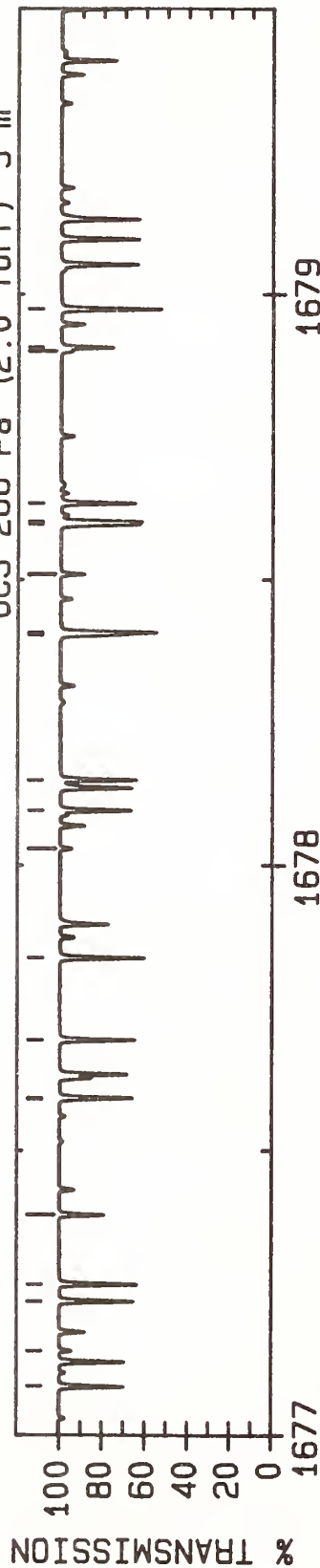

WAVELENGTHS (cm⁻¹)

LINE #	WAVENUMBER(unc) (cm ⁻¹)	LOWER STATE (cm ⁻¹)	INTENSITY (cm/molecule)	ASSIGNMENT ROTATION BAND	LINE #	WAVENUMBER(unc) (cm ⁻¹)	LOWER STATE (cm ⁻¹)	INTENSITY (cm/molecule)	ASSIGNMENT ROTATION BAND
1	1677.086 69(10)*	940.66	0.952E-22	P(45) B	36	1680.087 66(10)*	837.16	0.137E-21	P(39) B
2	1677.149 65(24)	1109.30	0.159E-22	P(17) G	37	1680.100 58(8)*	843.13	0.218E-21	P(64) A
3	1677.236 70(9)*	149.59	0.115E-21	P(27) P	38	1680.118 34(10)*	837.49	0.137E-21	P(39) C
4	1677.266 59(8)*	978.78	0.121E-21	P(69) A	39	1680.191 70(25)	1069.42	0.114E-22	P(10) G
5	1677.388 26(12)*	1241.47	0.630E-22	P(43) D	40	1680.389 43(9)*	83.11	0.118E-21	P(20) P
6	1677.590 58(24)	1102.39	0.155E-22	P(16) G	41	1680.403 71(12)*	1143.24	0.876E-22	P(37) D
7	1677.592 54(10)*	922.39	0.102E-21	P(44) B	42	1680.579 86(10)*	821.33	0.144E-21	P(38) B
8	1677.694 19(9)*	138.90	0.117E-21	P(26) P	43	1680.608 60(10)*	821.64	0.144E-21	P(38) C
9	1677.838 33(8)*	950.85	0.137E-21	P(68) A	44	1680.659 98(8)*	817.21	0.243E-21	P(63) A
10	1678.029 39(24)	1095.88	0.150E-22	P(15) G	45	1680.830 34(9)*	75.19	0.117E-21	P(19) P
11	1678.096 12(10)*	904.54	0.109E-21	P(43) B	46	1681.041 78(25)	1061.69	0.944E-23	P(8) G
12	1678.149 32(9)*	128.62	0.118E-21	P(25) P	47	1681.069 80(10)*	805.90	0.151E-21	P(37) B
13	1678.403 36(12)*	1207.11	0.710E-22	P(41) D	48	1681.096 64(10)*	806.20	0.151E-21	P(37) C
14	1678.407 60(8)*	923.31	0.154E-21	P(67) A	49	1681.216 91(8)*	791.70	0.271E-21	P(62) A
15	1678.509 52(25)	1096.66	0.157E-22	P(16) E	50	1681.388 98(12)*	1113.73	0.956E-22	P(35) D
16	1678.509 63(25)	1096.66	0.157E-22	P(16) F	51	1681.557 46(9)*	790.88	0.158E-21	P(36) B
17	1678.597 42(10)*	887.08	0.115E-21	P(42) B	52	1681.582 47(10)*	791.16	0.158E-21	P(36) C
18	1678.602 08(9)*	118.72	0.119E-21	P(24) P	53	1681.705 05(9)*	60.55	0.112E-21	P(17) P
19	1678.634 28(10)*	887.47	0.115E-21	P(42) C	54	1681.713 61(14)	400.19	0.142E-22	P(44) T
20	1678.900 67(24)	1084.07	0.138E-22	P(13) G	55	1681.771 37(8)*	766.58	0.301E-21	P(61) A
21	1678.907 18(12)*	1190.54	0.751E-22	P(40) D	56	1681.877 88(12)*	1099.58	0.996E-22	P(34) D
22	1678.974 40(8)*	896.18	0.173E-21	P(66) A	57	1681.883 37(25)	1055.59	0.730E-23	P(6) G
23	1679.052 47(9)*	109.23	0.120E-21	P(23) P	58	1682.042 86(9)*	776.26	0.165E-21	P(35) B
24	1679.096 44(10)*	870.04	0.122E-21	P(41) B	59	1682.066 09(10)*	776.53	0.165E-21	P(35) C
25	1679.131 19(10)*	870.40	0.122E-21	P(41) C	60	1682.138 86(9)*	53.83	0.109E-21	P(16) P
26	1679.136 09(15)	495.14	0.995E-23	P(49) T	61	1682.221 84(13)	382.42	0.151E-22	P(43) T
27	1679.333 13(24)	1078.78	0.130E-22	P(12) G	62	1682.323 38(8)*	741.87	0.334E-21	P(60) A
28	1679.408 51(12)*	1174.37	0.793E-22	P(39) D	63	1682.362 80(37)	573.60	0.925E-23	R(16) R
29	1679.500 49(9)*	100.13	0.120E-21	P(22) P	64	1682.364 30(12)*	1085.84	0.103E-21	P(33) D
30	1679.538 72(8)*	869.46	0.194E-21	P(65) A	65	1682.525 98(9)*	762.05	0.172E-21	P(34) B
31	1679.593 19(10)*	853.39	0.129E-21	P(40) B	66	1682.547 50(9)*	762.31	0.172E-21	P(34) C
32	1679.625 87(10)*	853.74	0.129E-21	P(40) C	67	1682.570 29(9)*	47.49	0.106E-21	P(15) P
33	1679.763 48(25)	1073.90	0.122E-22	P(11) G	68	1682.653 91(45)	296.75	0.143E-22	P(38) L
34	1679.907 36(12)*	1158.61	0.834E-22	P(38) D	69	1682.848 24(12)*	1072.49	0.107E-21	P(32) D
35	1679.946 15(9)*	91.42	0.119E-21	P(21) P	70	1682.872 93(8)*	717.57	0.370E-21	P(59) A

OCS 266 Pa (2.0 Torr) 3 m

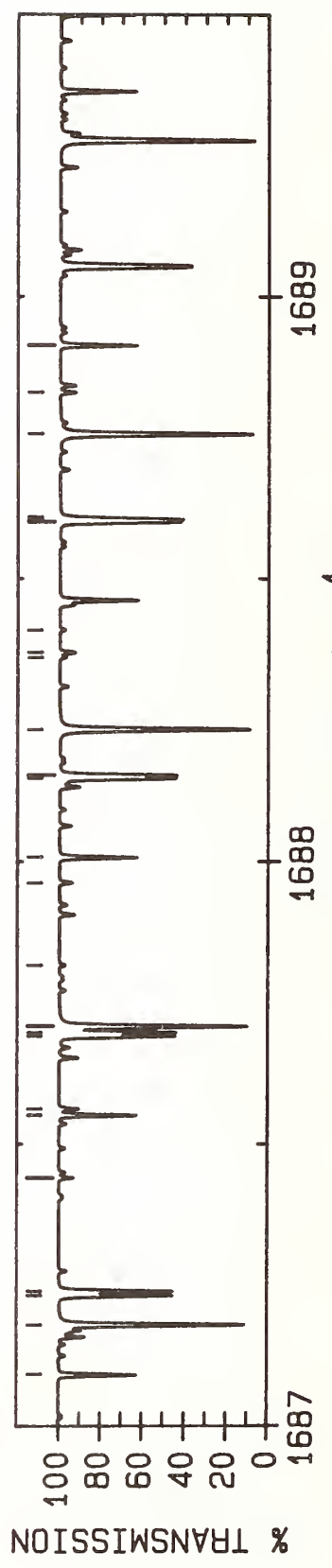
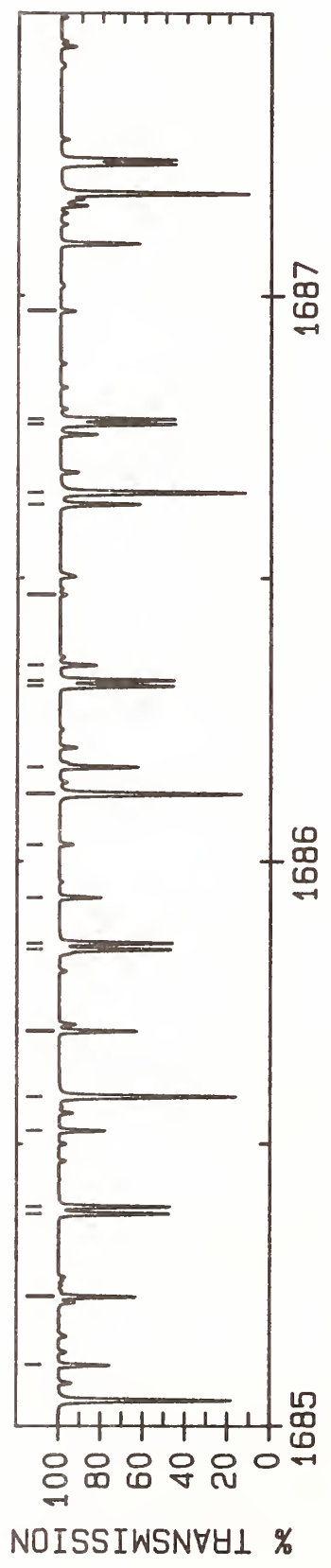
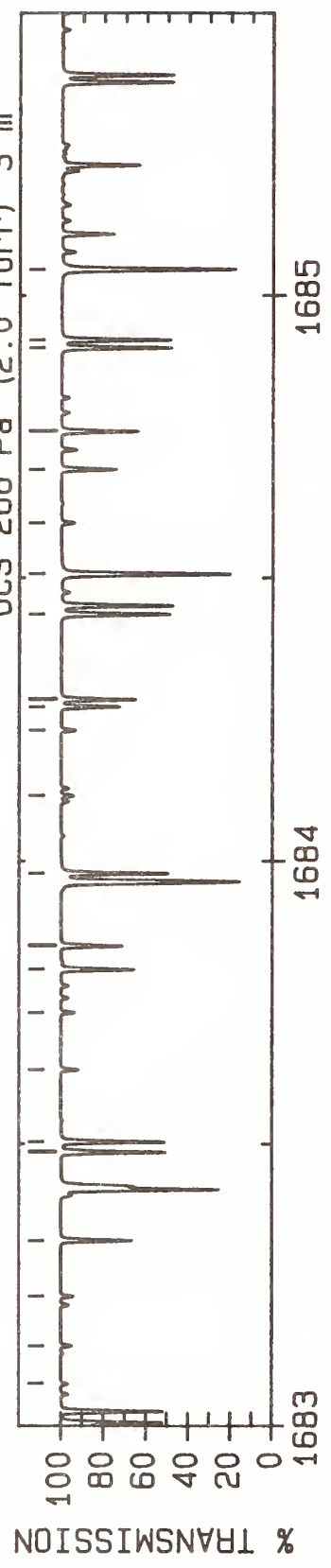

WAVENUMBERS (cm⁻¹)

LINE #	WAVENUMBER(unc) (cm ⁻¹)	LOWER STATE (cm ⁻¹)	INTENSITY (cm/molecule)	ASSIGNMENT ROTATION BAND	LINE #	WAVENUMBER(unc) (cm ⁻¹)	LOWER STATE (cm ⁻¹)	INTENSITY (cm/molecule)	ASSIGNMENT ROTATION BAND
1	1683.075 48(35)	587.48	0.967E-23	R(18)	36	1686.166 33(11)*	990.41	0.125E-21	D
2	1683.143 40(45)	281.54	0.150E-22	P(37)	37	1686.309 47(9)*	662.98	0.213E-21	B
3	1683.231 02(13)	348.07	0.171E-22	P(41)	38	1686.319 41(9)*	663.13	0.213E-21	C
4	1683.329 70(12)*	1059.56	0.110E-21	P(31)	39	1686.346 39(10)*	8.31	0.512E-22	P(6)
5	1683.485 44(9)*	734.85	0.185E-21	P(32)	40	1686.470 46(32)	680.52	0.943E-23	Q
6	1683.503 70(9)*	735.07	0.185E-21	P(32)	41	1686.630 42(11)*	980.30	0.126E-21	D
7	1683.630 50(44)	266.73	0.157E-22	P(36)	42	1686.651 01(8)*	558.74	0.708E-21	A
8	1683.731 98(12)	331.50	0.180E-22	P(40)	43	1686.772 23(9)*	652.42	0.216E-21	B
9	1683.808 67(12)*	1047.02	0.113E-21	P(30)	44	1686.780 99(9)*	652.56	0.216E-21	C
10	1683.850 35(10)*	30.87	0.916E-22	P(12)	45	1686.972 94(36)	174.23	0.199E-22	L
11	1683.978 49(9)*	722.07	0.190E-21	P(31)	46	1687.092 03(11)*	970.60	0.126E-21	D
12	1684.115 19(43)	252.31	0.164E-22	P(35)	47	1687.180 93(8)*	537.67	0.769E-21	A
13	1684.230 52(12)	315.33	0.190E-22	P(39)	48	1687.232 72(9)*	642.27	0.218E-21	B
14	1684.272 29(10)*	26.12	0.859E-22	P(11)	49	1687.240 37(9)*	642.40	0.217E-21	C
15	1684.285 16(11)*	1034.89	0.116E-21	P(29)	50	1687.440 83(35)	162.62	0.203E-22	L
16	1684.435 84(9)*	709.27	0.196E-21	P(30)	51	1687.551 16(11)*	961.29	0.127E-21	D
17	1684.506 82(8)*	647.08	0.495E-21	P(56)	52	1687.562 33(10)*	2.38	0.264E-22	P(3)
18	1684.597 48(42)	238.30	0.171E-22	P(34)	53	1687.690 96(9)*	632.52	0.219E-21	B
19	1684.691 86(10)*	21.77	0.798E-22	P(10)	54	1687.697 55(9)*	632.64	0.219E-21	C
20	1684.759 18(11)*	1023.17	0.119E-21	P(28)	55	1687.708 41(8)*	517.00	0.834E-21	A
21	1684.907 64(9)*	697.09	0.201E-21	P(29)	56	1687.816 89(32)	729.06	0.848E-23	R
22	1684.921 46(9)*	697.27	0.201E-21	P(29)	57	1687.962 89(10)*	1.19	0.177E-22	P(2)
23	1685.046 55(8)*	624.39	0.543E-21	P(55)	58	1688.007 82(11)*	952.40	0.126E-21	D
24	1685.109 05(10)*	17.81	0.732E-22	P(9)	59	1688.146 93(9)*	623.18	0.219E-21	B
25	1685.230 71(11)*	1011.84	0.121E-21	P(27)	60	1688.152 54(9)*	623.29	0.219E-21	C
26	1685.377 18(9)*	685.31	0.206E-21	P(28)	61	1688.233 43(8)*	496.74	0.902E-21	A
27	1685.389 65(9)*	685.49	0.206E-21	P(28)	62	1688.361 06(10)*	0.40	0.887E-23	P(1)
28	1685.523 87(10)*	14.25	0.662E-22	P(8)	63	1688.369 42(33)	140.59	0.210E-22	L
29	1685.583 82(8)*	602.10	0.595E-21	P(54)	64	1688.409 32(35)	755.38	0.792E-23	Q
30	1685.699 76(11)*	1000.93	0.123E-21	P(26)	65	1688.600 64(9)*	614.25	0.218E-21	B
31	1685.844 46(9)*	673.94	0.210E-21	P(27)	66	1688.605 32(9)*	614.35	0.218E-21	C
32	1685.855 63(9)*	674.10	0.210E-21	P(27)	67	1688.608 61(10)	188.01	0.273E-22	T
33	1685.936 32(10)*	11.08	0.589E-22	P(7)	68	1688.756 02(8)*	476.88	0.973E-21	A
34	1686.029 96(39)	198.66	0.189E-22	P(31)	69	1688.830 12(32)	130.18	0.213E-22	L
35	1686.118 64(8)*	580.22	0.649E-21	P(53)	70	1688.913 68(11)*	935.82	0.124E-21	D

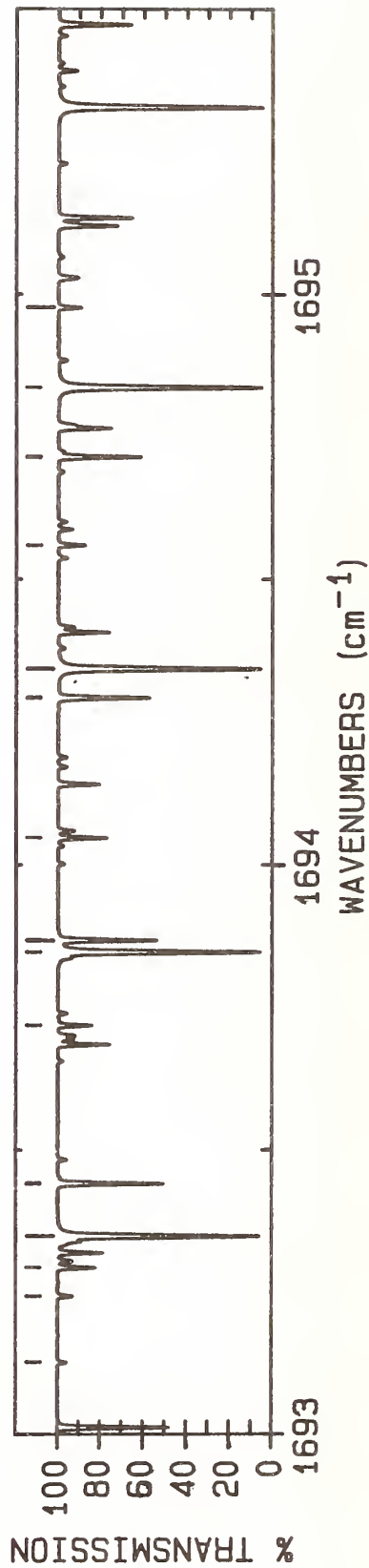
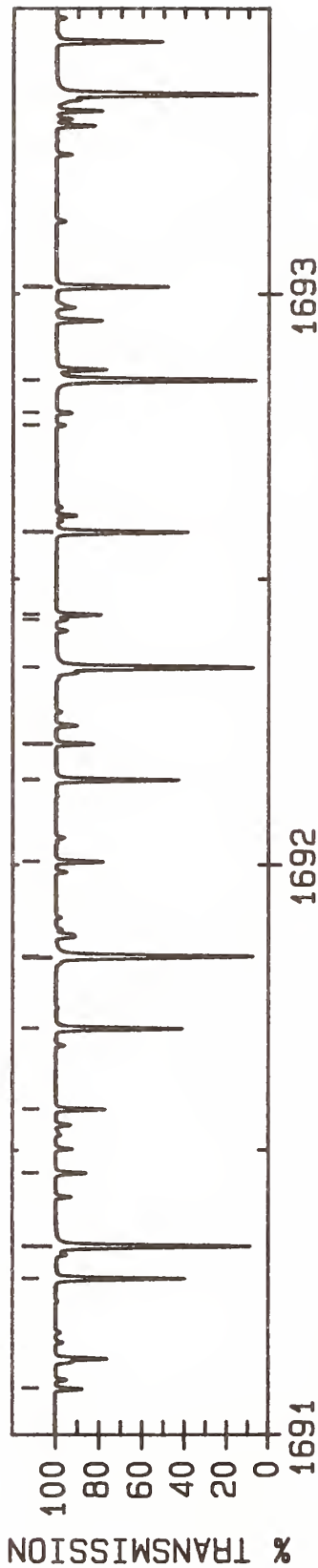
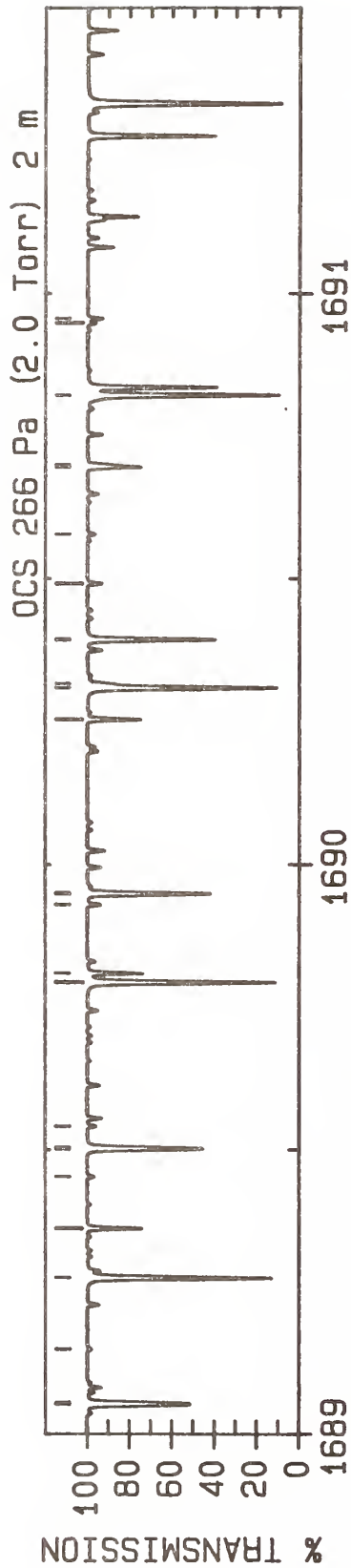

LINE #	WAVENUMBER(unc) (cm ⁻¹)	LOWER STATE (cm ⁻¹)	INTENSITY (cm/molecule)	ASSIGNMENT ROTATION BAND	LINE #	WAVENUMBER(unc) (cm ⁻¹)	LOWER STATE (cm ⁻¹)	INTENSITY (cm/molecule)	ASSIGNMENT ROTATION BAND
1	1689.052 10(9)*	605.72	0.217E-21	P(20) B	36	1691.840 23(8)*	366.22	0.146E-20	P(42) A
2	1689.055 91(9)*	605.81	0.217E-21	P(20) C	37	1692.006 09(12)*	890.52	0.977E-22	P(12) D
3	1689.150 27(10)*	0.00	0.889E-23	R(0) P	38	1692.148 56(9)*	557.42	0.178E-21	P(13) C
4	1689.276 16(8)*	457.42	0.105E-20	P(47) A	39	1692.149 01(9)*	557.38	0.178E-21	P(13) B
5	1689.362 90(11)*	928.13	0.122E-21	P(18) D	40	1692.211 70(10)*	14.25	0.748E-22	R(8) P
6	1689.453 31(24)	1078.78	0.142E-22	R(12) G	41	1692.345 73(8)*	349.19	0.155E-20	P(41) A
7	1689.501 29(9)*	597.60	0.214E-21	P(19) B	42	1692.429 29(34)	61.29	0.203E-22	P(17) L
8	1689.504 31(9)*	597.68	0.214E-21	P(19) C	43	1692.437 94(12)*	885.66	0.917E-22	P(11) D
9	1689.541 31(10)*	0.40	0.178E-22	R(1) P	44	1692.581 58(9)*	552.14	0.168E-21	P(12) C
10	1689.793 85(8)*	438.37	0.113E-20	P(46) A	45	1692.582 38(9)*	552.11	0.168E-21	P(12) B
11	1689.809 63(12)*	920.85	0.119E-21	P(17) D	46	1692.583 62(10)*	17.81	0.817E-22	R(9) P
12	1689.929 95(10)*	1.19	0.265E-22	R(2) P	47	1692.769 67(24)	1141.04	0.178E-22	R(21) G
13	1689.948 23(9)*	589.88	0.211E-21	P(18) B	48	1692.791 24(11)	93.41	0.303E-22	P(21) T
14	1689.950 51(9)*	589.95	0.211E-21	P(18) C	49	1692.848 79(8)*	332.57	0.164E-20	P(40) A
15	1690.253 88(12)*	913.98	0.116E-21	P(16) D	50	1693.012 40(9)*	547.26	0.158E-21	P(11) C
16	1690.309 11(8)*	419.73	0.121E-20	P(45) A	51	1693.013 50(9)*	547.23	0.158E-21	P(11) B
17	1690.316 21(10)*	2.38	0.352E-22	R(3) P	52	1693.127 45(23)	1149.99	0.178E-22	R(22) G
18	1690.392 90(9)*	582.57	0.206E-21	P(17) B	53	1693.243 93(11)	84.92	0.301E-22	P(20) T
19	1690.394 51(9)*	582.63	0.206E-21	P(17) C	54	1693.294 19(12)*	877.17	0.782E-22	P(9) D
20	1690.491 67(10)	141.93	0.296E-22	P(26) T	55	1693.349 41(8)*	316.35	0.173E-20	P(39) A
21	1690.578 04(24)	1095.88	0.161E-22	R(15) G	56	1693.441 03(9)*	542.79	0.146E-21	P(10) C
22	1690.695 66(12)*	907.50	0.112E-21	P(15) D	57	1693.442 35(9)*	542.76	0.146E-21	P(10) B
23	1690.700 09(10)*	3.96	0.437E-22	R(4) P	58	1693.718 59(12)*	873.53	0.708E-22	P(8) D
24	1690.821 92(8)*	401.49	0.129E-20	P(44) A	59	1693.847 60(8)*	300.54	0.182E-20	P(38) A
25	1690.948 67(24)	1102.39	0.166E-22	R(16) G	60	1693.867 47(9)*	538.72	0.134E-21	P(9) C
26	1690.956 41(10)	131.41	0.300E-22	P(25) T	61	1693.868 94(9)*	538.70	0.134E-21	P(9) B
27	1691.081 57(10)*	5.94	0.519E-22	R(5) P	62	1694.047 36(9)*	36.02	0.105E-21	R(13) P
28	1691.275 47(9)*	569.16	0.194E-21	P(15) B	63	1694.291 70(9)*	535.06	0.121E-21	P(8) C
29	1691.275 92(9)*	569.22	0.194E-21	P(15) C	64	1694.293 27(9)*	535.04	0.121E-21	P(8) B
30	1691.332 30(8)*	383.65	0.137E-20	P(43) A	65	1694.343 35(8)*	285.13	0.191E-20	P(37) A
31	1691.460 67(10)*	8.31	0.599E-22	R(6) P	66	1694.559 93(12)*	867.46	0.547E-22	P(6) D
32	1691.571 76(12)*	895.77	0.103E-21	P(13) D	67	1694.713 74(9)*	531.81	0.107E-21	P(7) C
33	1691.713 34(9)*	563.12	0.186E-21	P(14) C	68	1694.715 34(9)*	531.80	0.107E-21	P(7) B
34	1691.713 37(9)*	563.07	0.186E-21	P(14) B	69	1694.836 67(8)*	270.13	0.200E-20	P(36) A
35	1691.837 38(10)*	11.08	0.675E-22	R(7) P	70	1694.976 88(12)*	865.03	0.461E-22	P(5) D

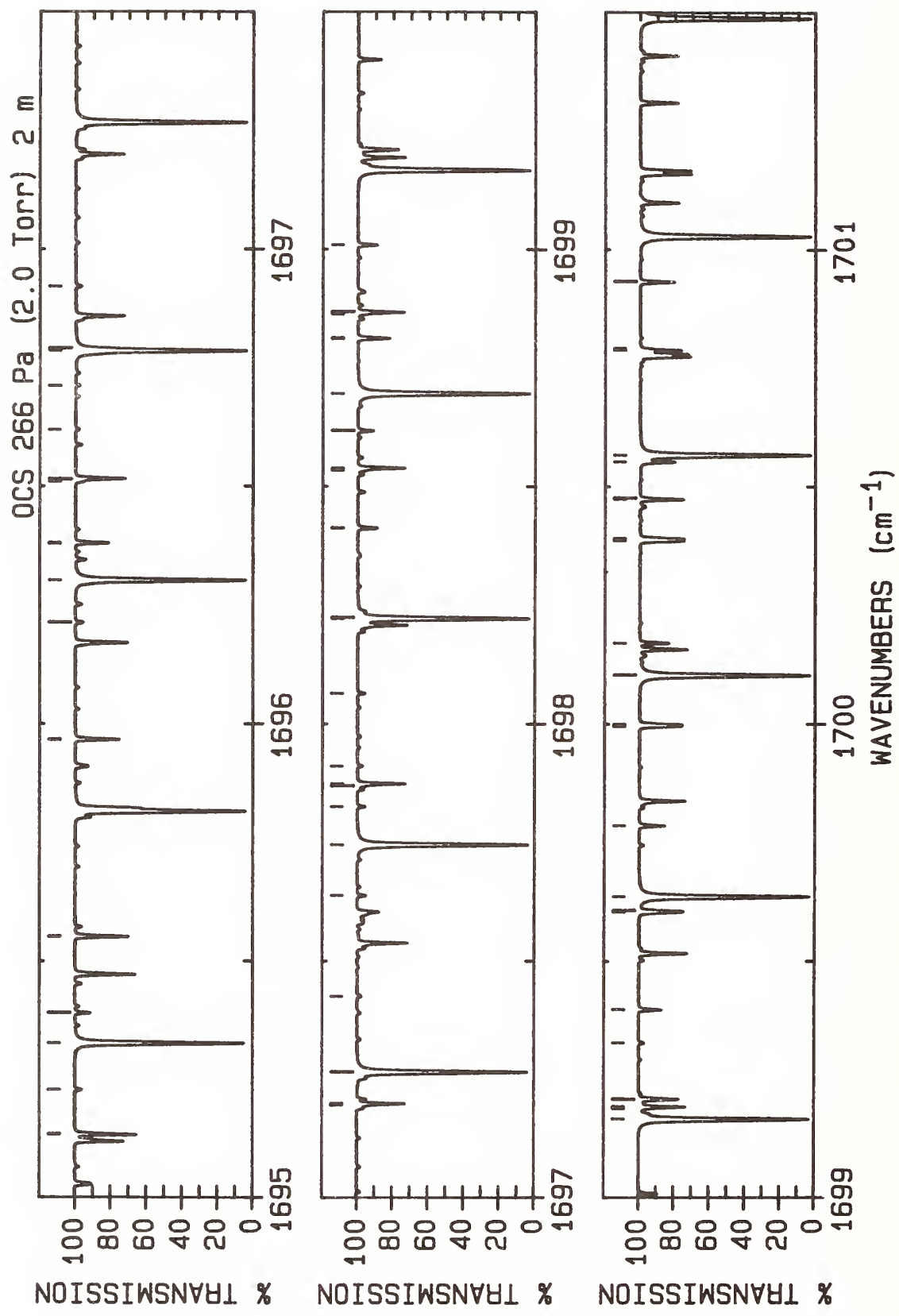

LINE #	WAVENUMBER(unc) (cm ⁻¹)	LOWER STATE (cm ⁻¹)	INTENSITY (cm/molecule)	ASSIGNMENT ROTATION BAND	LINE #	WAVENUMBER(unc) (cm ⁻¹)	LOWER STATE (cm ⁻¹)	INTENSITY (cm/molecule)	ASSIGNMENT ROTATION BAND
1	1695.133 58(9)*	528.96	0.924E-22	P(6)	36	1698.412 00(9)*	520.83	0.248E-22	R(1)
2	1695.135 15(9)*	528.95	0.924E-22	P(6)	37	1698.413 05(9)*	520.83	0.248E-22	R(1)
3	1695.229 08(24)	1212.24	0.166E-22	R(28)	38	1698.533 64(24)	1297.71	0.136E-22	R(35)
4	1695.327 55(8)*	255.53	0.209E-20	P(35)	39	1698.538 71(9)*	138.90	0.123E-21	R(26)
5	1695.391 33(12)*	863.01	0.373E-22	P(4)	40	1698.617 38(12)*	861.39	0.377E-22	R(3)
6	1695.551 22(9)*	526.52	0.769E-22	P(5)	41	1698.695 61(8)*	164.69	0.261E-20	P(28)
7	1695.552 69(9)*	526.51	0.769E-22	P(5)	42	1698.811 40(9)*	521.64	0.438E-22	R(2)
8	1695.966 65(9)*	524.49	0.607E-22	P(4)	43	1698.813 06(9)*	521.64	0.438E-22	R(2)
9	1695.967 96(9)*	524.48	0.607E-22	P(4)	44	1698.862 71(24)	1312.36	0.130E-22	R(36)
10	1696.212 79(12)*	860.18	0.189E-22	P(2)	45	1698.867 29(9)*	149.59	0.121E-21	R(27)
11	1696.302 01(8)*	227.55	0.226E-20	P(33)	46	1699.009 41(12)*	863.01	0.467E-22	R(4)
12	1696.379 89(9)*	522.86	0.435E-22	P(3)	47	1699.167 04(8)*	153.34	0.265E-20	P(27)
13	1696.380 97(9)*	522.86	0.435E-22	P(3)	48	1699.189 62(24)	1327.41	0.124E-22	R(37)
14	1696.509 57(93)	1218.35	0.166E-22	R(29)	49	1699.193 44(9)*	160.67	0.119E-21	R(28)
15	1696.513 95(24)	1218.36	0.166E-22	R(29)	50	1699.208 52(9)*	522.86	0.613E-22	R(3)
16	1696.516 43(9)*	83.11	0.125E-21	R(20)	51	1699.210 87(9)*	522.86	0.613E-22	R(3)
17	1696.619 78(12)*	859.37	0.949E-23	P(1)	52	1699.328 31(15)	8.49	0.131E-22	P(6)
18	1696.712 14(47)	11.22	0.107E-22	P(7)	53	1699.398 95(12)*	865.03	0.555E-22	R(5)
19	1696.785 60(8)*	214.17	0.234E-20	P(32)	54	1699.603 37(9)*	524.48	0.779E-22	R(4)
20	1696.790 93(9)*	521.64	0.246E-22	P(2)	55	1699.606 47(9)*	524.49	0.779E-22	R(4)
21	1696.791 71(9)*	521.64	0.246E-22	P(2)	56	1699.636 03(8)*	142.38	0.270E-20	P(26)
22	1696.921 52(24)	1275.30	0.143E-22	R(33)	57	1699.785 99(12)*	867.46	0.640E-22	R(6)
23	1697.195 78(24)	1243.18	0.157E-22	R(31)	58	1699.995 94(9)*	526.51	0.937E-22	R(5)
24	1697.200 19(9)*	100.13	0.126E-21	R(22)	59	1699.999 86(9)*	526.52	0.937E-22	R(5)
25	1697.266 75(8)*	201.19	0.241E-20	P(31)	60	1700.102 60(8)*	131.84	0.273E-20	P(25)
26	1697.426 30(12)*	858.97	0.952E-23	R(0)	61	1700.170 53(12)*	870.29	0.722E-22	R(7)
27	1697.638 16(14)	22.24	0.205E-22	P(10)	62	1700.386 24(9)*	528.95	0.109E-21	R(6)
28	1697.745 47(8)*	188.62	0.248E-20	P(30)	63	1700.391 03(9)*	528.96	0.109E-21	R(6)
29	1697.825 82(12)*	859.37	0.190E-22	R(1)	64	1700.473 73(9)*	208.93	0.107E-21	R(32)
30	1697.869 02(24)	1269.63	0.147E-22	R(33)	65	1700.475 48(23)	1391.69	0.101E-22	R(41)
31	1697.874 29(9)*	118.72	0.125E-21	R(24)	66	1700.552 57(12)*	873.53	0.800E-22	R(8)
32	1697.911 29(24)	1318.01	0.127E-22	R(36)	67	1700.566 73(8)*	121.70	0.275E-20	P(24)
33	1698.064 32(14)	18.20	0.188E-22	P(9)	68	1700.787 72(9)*	221.99	0.104E-21	R(33)
34	1698.221 75(8)*	176.45	0.255E-20	P(29)	69	1700.791 49(23)	1408.78	0.948E-23	R(42)
35	1698.222 84(12)*	860.18	0.284E-22	R(2)	70	1700.932 10(12)*	877.17	0.873E-22	R(9)

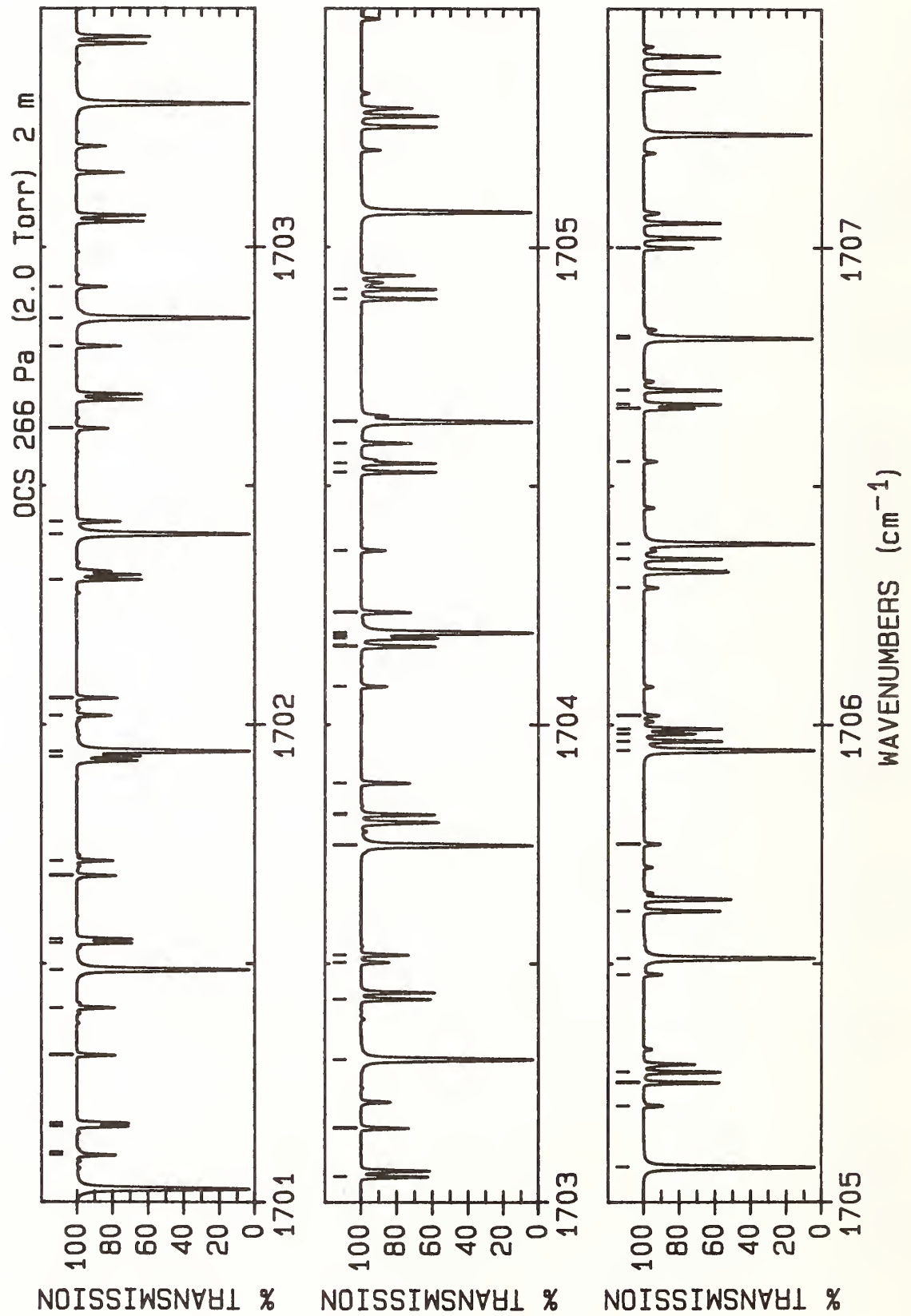

LINE #	WAVENUMBER(unc) (cm ⁻¹)	LOWER STATE (cm ⁻¹)	INTENSITY (cm/molecule)	ASSIGNMENT ROTATION BAND	LINE #	WAVENUMBER(unc) (cm ⁻¹)	LOWER STATE (cm ⁻¹)	INTENSITY (cm/molecule)	ASSIGNMENT ROTATION BAND
1	1701.099 27(9)*	235.44	0.998E-22	R(34) P	36	1704.166 60(15)	6.07	0.133E-22	R(5) T
2	1701.105 31(23)	1426.27	0.892E-23	R(43) F	37	1704.180 73(9)*	575.72	0.215E-21	R(16) C
3	1701.159 99(9)*	535.04	0.137E-21	R(8) B	38	1704.185 72(40)	26.44	0.171E-22	R(11) L
4	1701.166 74(9)*	535.06	0.137E-21	R(8) C	39	1704.192 29(8)*	55.17	0.254E-20	P(16) A
5	1701.309 13(12)*	881.21	0.942E-22	R(10) D	40	1704.235 00(11)*	928.13	0.130E-21	R(18) D
6	1701.408 37(9)*	249.29	0.960E-22	R(35) P	41	1704.364 57(9)*	409.47	0.564E-22	R(45) P
7	1701.487 70(8)*	102.63	0.277E-20	P(22) A	42	1704.528 74(9)*	582.57	0.220E-21	R(17) B
8	1701.543 45(9)*	538.70	0.150E-21	R(9) B	43	1704.547 45(9)*	582.63	0.220E-21	R(17) C
9	1701.551 27(9)*	538.72	0.150E-21	R(9) C	44	1704.589 41(11)*	935.82	0.132E-21	R(19) D
10	1701.683 66(12)*	885.66	0.101E-21	R(11) D	45	1704.634 55(8)*	48.68	0.246E-20	P(15) A
11	1701.715 03(9)*	263.53	0.921E-22	R(36) P	46	1704.891 58(9)*	589.88	0.224E-21	R(18) B
12	1701.933 58(9)*	542.79	0.162E-21	R(10) C	47	1704.911 94(9)*	589.95	0.224E-21	R(18) C
13	1701.944 55(8)*	93.71	0.276E-20	P(21) A	48	1705.074 37(8)*	42.60	0.237E-20	P(14) A
14	1702.019 25(9)*	278.16	0.881E-22	R(37) P	49	1705.203 38(9)*	465.23	0.458E-22	R(48) P
15	1702.055 67(12)*	890.52	0.106E-21	R(12) D	50	1705.252 12(9)*	597.60	0.228E-21	R(19) B
16	1702.303 51(9)*	547.23	0.173E-21	R(11) B	51	1705.274 19(9)*	597.68	0.228E-21	R(19) C
17	1702.303 60(46)	8.41	0.109E-22	R(6) L	52	1705.478 03(9)*	484.60	0.426E-22	R(49) P
18	1702.398 96(8)*	85.19	0.274E-20	P(20) A	53	1705.511 77(8)*	36.92	0.226E-20	P(13) A
19	1702.425 18(12)*	895.77	0.112E-21	R(13) D	54	1705.610 35(9)*	605.72	0.230E-21	R(20) B
20	1702.620 32(9)*	308.62	0.800E-22	R(39) P	55	1705.750 20(9)*	504.37	0.395E-22	R(50) P
21	1702.792 17(12)*	901.44	0.116E-21	R(14) D	56	1705.946 72(8)*	31.64	0.214E-20	P(12) A
22	1702.850 94(8)*	77.08	0.271E-20	P(19) A	57	1705.966 28(9)*	614.25	0.231E-21	R(21) B
23	1702.917 18(9)*	324.44	0.759E-22	R(40) P	58	1705.981 79(11)*	970.60	0.133E-21	R(23) D
24	1703.054 42(9)*	557.38	0.193E-21	R(13) B	59	1705.991 96(9)*	614.35	0.231E-21	R(21) C
25	1703.156 65(12)*	907.50	0.121E-21	R(15) D	60	1706.019 89(9)*	524.53	0.365E-22	R(51) P
26	1703.300 49(8)*	69.37	0.267E-20	P(18) A	61	1706.287 08(9)*	545.09	0.337E-22	R(52) P
27	1703.426 44(9)*	563.07	0.201E-21	R(14) B	62	1706.347 48(9)*	623.29	0.231E-21	R(22) C
28	1703.503 53(9)*	357.27	0.679E-22	R(42) P	63	1706.379 25(8)*	26.78	0.201E-20	P(11) A
29	1703.518 62(11)*	913.98	0.124E-21	R(16) D	64	1706.551 79(9)*	566.04	0.310E-22	R(53) P
30	1703.747 61(8)*	62.07	0.261E-20	P(17) A	65	1706.662 79(11)*	990.41	0.131E-21	R(25) D
31	1703.811 77(9)*	569.22	0.209E-21	R(15) C	66	1706.671 21(9)*	632.52	0.231E-21	R(23) B
32	1703.814 15(41)	22.03	0.160E-22	R(10) L	67	1706.700 75(9)*	632.64	0.231E-21	R(23) C
33	1703.878 07(11)*	920.85	0.127E-21	R(17) D	68	1706.809 34(8)*	22.31	0.187E-20	P(10) A
34	1704.080 02(9)*	391.68	0.602E-22	R(44) P	69	1706.814 00(9)*	587.39	0.285E-22	R(54) P
35	1704.163 60(9)*	575.66	0.215E-21	R(16) B	70	1706.999 49(11)*	1000.93	0.130E-21	R(26) D

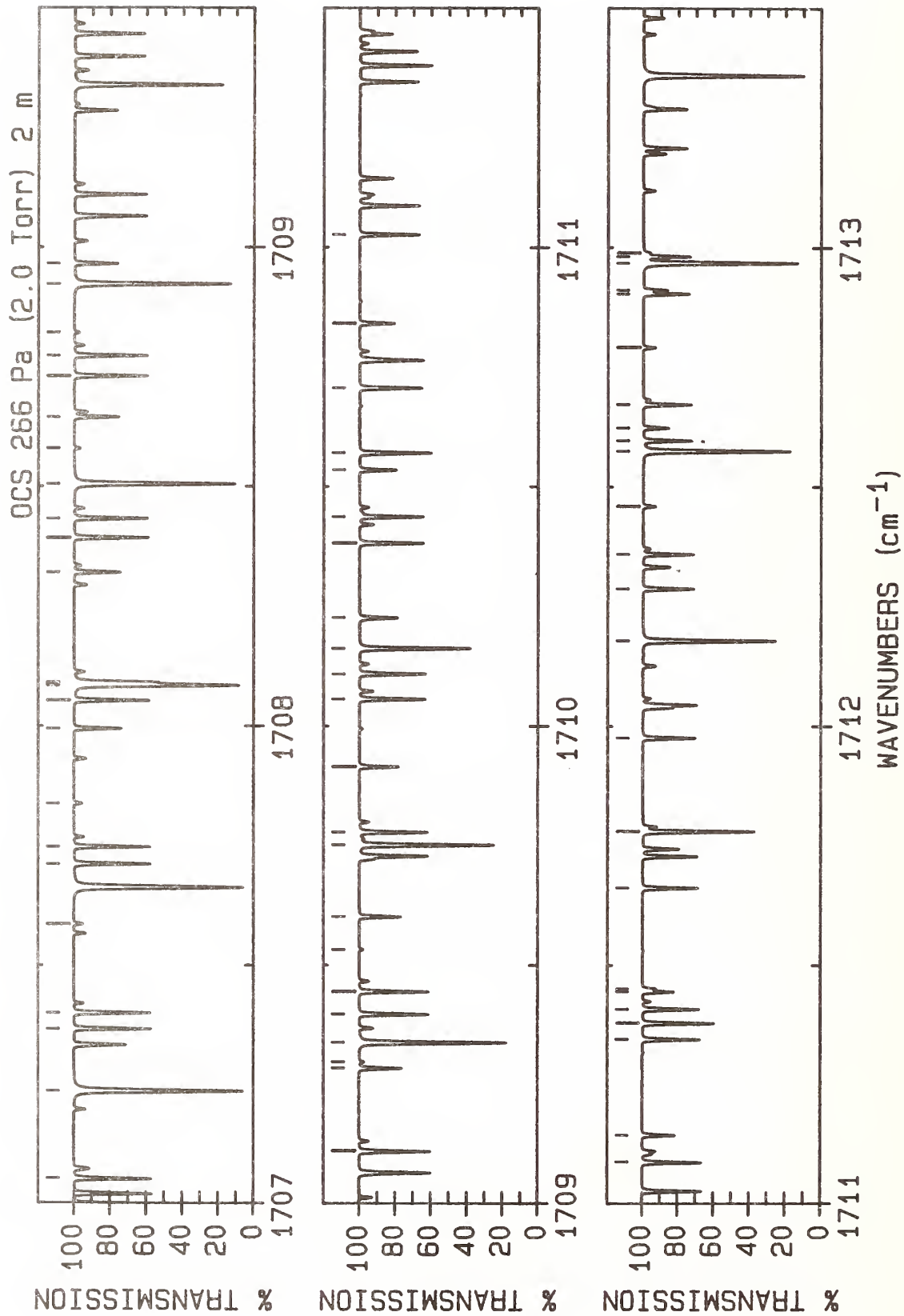

LINE #	WAVENUMBER(unc) (cm ⁻¹)	LOWER STATE (cm ⁻¹)	INTENSITY (cm/molecule)	ASSIGNMENT ROTATION BAND	LINE #	WAVENUMBER(unc) (cm ⁻¹)	LOWER STATE (cm ⁻¹)	INTENSITY (cm/molecule)	ASSIGNMENT ROTATION BAND
1	1707.051 77(9)*	642.40	0.229E-21	R(24) C	36	1710.056 70(9)*	748.25	0.187E-21	R(33) B
2	1707.237 00(8)*	18.26	0.171E-20	P(9) A	37	1710.109 18(10)*	748.49	0.187E-21	R(33) C
3	1707.366 90(9)*	652.42	0.227E-21	R(25) B	38	1710.162 37(8)*	1.22	0.415E-21	P(2) A
4	1707.400 54(9)*	652.56	0.227E-21	R(25) C	39	1710.226 42(12)*	1128.29	0.958E-22	R(36) D
5	1707.585 65(9)*	653.80	0.217E-22	R(57) P	40	1710.382 43(9)*	762.05	0.180E-21	R(34) B
6	1707.711 26(9)*	662.98	0.224E-21	R(26) B	41	1710.437 52(10)*	762.31	0.180E-21	R(34) C
7	1707.747 05(9)*	663.13	0.224E-21	R(26) C	42	1710.535 04(12)*	1143.24	0.915E-22	R(37) D
8	1707.837 85(9)*	676.72	0.198E-22	R(58) P	43	1710.570 53(8)*	0.41	0.208E-21	P(1) A
9	1707.994 35(12)*	1034.89	0.122E-21	R(29) D	44	1710.705 81(10)*	776.26	0.173E-21	R(35) B
10	1708.053 31(9)*	673.94	0.220E-21	R(27) B	45	1710.841 10(12)*	1158.61	0.872E-22	R(38) D
11	1708.085 01(8)*	11.36	0.138E-20	P(7) A	46	1711.026 84(10)*	790.88	0.165E-21	R(36) B
12	1708.087 55(9)*	700.04	0.180E-22	R(59) P	47	1711.087 35(10)*	791.16	0.165E-21	R(36) C
13	1708.091 30(9)*	674.10	0.220E-21	R(27) C	48	1711.144 59(12)*	1174.37	0.829E-22	R(39) D
14	1708.320 88(12)*	1047.02	0.119E-21	R(30) D	49	1711.345 53(10)*	805.90	0.158E-21	R(37) B
15	1708.393 03(9)*	685.31	0.216E-21	R(28) B	50	1711.379 51(8)*	0.00	0.209E-21	R(0) A
16	1708.433 29(9)*	685.49	0.216E-21	R(28) C	51	1711.408 83(10)*	806.20	0.158E-21	R(37) C
17	1708.505 36(8)*	8.52	0.120E-20	P(6) A	52	1711.445 50(12)*	1190.54	0.785E-22	R(40) D
18	1708.579 41(10)*	747.86	0.147E-22	R(61) P	53	1711.451 70(10)	131.41	0.315E-22	R(25) T
19	1708.644 86(12)*	1059.56	0.116E-21	R(31) D	54	1711.661 86(10)*	821.33	0.150E-21	R(38) B
20	1708.730 43(9)*	697.09	0.211E-21	R(29) B	55	1711.780 34(8)*	0.41	0.417E-21	R(1) A
21	1708.773 01(9)*	697.27	0.211E-21	R(29) C	56	1711.975 84(10)*	837.16	0.143E-21	R(39) B
22	1708.821 56(10)*	772.36	0.133E-22	R(62) P	57	1712.178 72(8)*	1.22	0.623E-21	R(2) A
23	1708.923 27(8)*	6.09	0.101E-20	P(5) A	58	1712.287 45(10)*	853.39	0.135E-21	R(40) B
24	1708.966 28(12)*	1072.49	0.112E-21	R(32) D	59	1712.359 46(10)*	853.74	0.135E-21	R(40) C
25	1709.110 46(9)*	709.47	0.206E-21	R(30) C	60	1712.459 79(10)	164.16	0.300E-22	R(28) T
26	1709.285 16(12)*	1085.84	0.108E-21	R(33) D	61	1712.574 66(8)*	2.43	0.826E-21	R(3) A
27	1709.298 29(11)*	822.54	0.107E-22	R(64) P	62	1712.596 70(10)*	870.04	0.128E-21	R(41) B
28	1709.338 74(8)*	4.06	0.818E-21	P(4) A	63	1712.623 34(12)*	1259.25	0.618E-22	R(44) D
29	1709.398 24(9)*	721.86	0.200E-21	R(31) B	64	1712.671 73(10)*	870.40	0.128E-21	R(41) C
30	1709.445 64(9)*	722.07	0.200E-21	R(31) C	65	1712.790 87(10)	175.88	0.293E-22	R(29) T
31	1709.532 86(12)*	848.22	0.962E-23	R(65) P	66	1712.903 59(10)*	887.08	0.121E-21	R(42) B
32	1709.601 47(12)*	1099.58	0.104E-21	R(34) D	67	1712.911 33(12)*	1277.44	0.578E-22	R(45) D
33	1709.751 78(8)*	2.43	0.618E-21	P(3) A	68	1712.968 14(8)*	4.06	0.102E-20	R(4) A
34	1709.778 55(9)*	735.07	0.193E-21	R(32) C	69	1712.981 69(10)*	887.47	0.120E-21	R(42) C
35	1709.915 23(12)*	1113.73	0.100E-21	R(35) D	70	1712.989 23(46)	281.54	0.157E-22	R(37) L

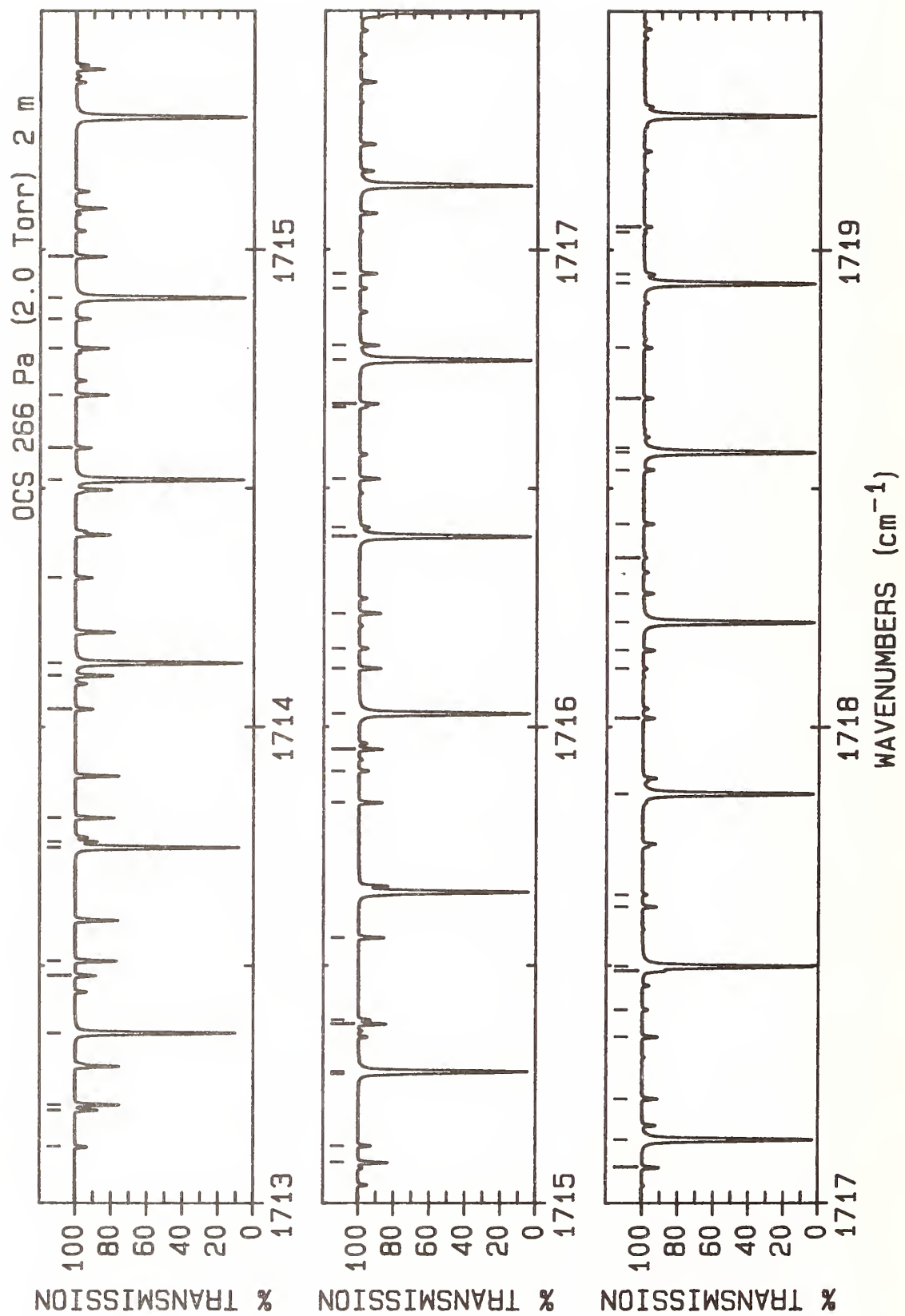

LINE #	WAVENUMBER(unc) (cm ⁻¹)	LOWER STATE (cm ⁻¹)	INTENSITY (cm/molecule)	ASSIGNMENT ROTATION BAND	LINE #	WAVENUMBER(unc) (cm ⁻¹)	LOWER STATE (cm ⁻¹)	INTENSITY (cm/molecule)	ASSIGNMENT ROTATION BAND
1	1713.119 48(10)	188.01	0.286E-22	R(30) T	36	1716.400 28(10)*	1123.25	0.491E-22	R(54) B
2	1713.196 73(12)*	1296.03	0.540E-22	R(46) D	37	1716.417 98(13)*	1550.55	0.197E-22	R(58) D
3	1713.208 11(10)*	904.54	0.113E-21	R(43) B	38	1716.519 29(10)*	1123.88	0.489E-22	R(54) C
4	1713.359 18(8)*	6.09	0.122E-20	R(5) A	39	1716.669 35(13)*	1574.38	0.178E-22	R(59) D
5	1713.479 53(12)*	1315.02	0.503E-22	R(47) D	40	1716.676 06(10)*	1145.56	0.448E-22	R(55) B
6	1713.510 25(10)*	922.39	0.106E-21	R(44) B	41	1716.768 12(8)*	42.60	0.255E-20	R(14) A
7	1713.747 77(8)*	8.52	0.140E-20	R(6) A	42	1716.798 79(10)*	1146.22	0.447E-22	R(55) C
8	1713.759 73(12)*	1334.42	0.467E-22	R(48) D	43	1716.918 07(13)*	1598.62	0.161E-22	R(60) D
9	1713.810 01(10)*	940.66	0.995E-22	R(45) B	44	1716.949 41(10)*	1168.28	0.408E-22	R(56) B
10	1714.037 33(12)*	1354.22	0.433E-22	R(49) D	45	1717.075 93(10)*	1168.96	0.407E-22	R(56) C
11	1714.107 39(10)*	959.33	0.928E-22	R(46) B	46	1717.134 59(8)*	48.68	0.265E-20	R(15) A
12	1714.133 91(8)*	11.36	0.158E-20	R(7) A	47	1717.220 34(10)*	1191.40	0.372E-22	R(57) B
13	1714.312 32(12)*	1374.42	0.400E-22	R(50) D	48	1717.350 69(10)*	1192.10	0.370E-22	R(57) C
14	1714.517 60(8)*	14.61	0.175E-20	R(8) A	49	1717.407 58(13)*	1648.29	0.131E-22	R(62) D
15	1714.584 70(12)*	1395.03	0.369E-22	R(51) D	50	1717.488 85(10)*	1214.93	0.337E-22	R(58) B
16	1714.695 00(10)*	997.88	0.803E-22	R(48) B	51	1717.498 59(8)*	55.17	0.272E-20	R(16) A
17	1714.792 64(10)*	998.38	0.801E-22	R(48) C	52	1717.623 06(10)*	1215.65	0.336E-22	R(58) C
18	1714.854 47(12)*	1416.04	0.340E-22	R(52) D	53	1717.648 36(13)*	1673.73	0.118E-22	R(63) D
19	1714.898 83(8)*	18.26	0.191E-20	R(9) A	54	1717.860 13(8)*	62.07	0.279E-20	R(17) A
20	1714.985 22(10)*	1017.76	0.744E-22	R(49) B	55	1718.018 55(10)*	1263.19	0.276E-22	R(60) B
21	1715.086 29(10)*	1018.28	0.742E-22	R(49) C	56	1718.121 93(14)*	1725.81	0.941E-23	R(65) D
22	1715.121 61(12)*	1437.45	0.312E-22	R(53) D	57	1718.160 63(11)*	1263.97	0.275E-22	R(60) C
23	1715.273 04(10)*	1038.05	0.688E-22	R(50) B	58	1718.219 20(8)*	69.37	0.284E-20	R(18) A
24	1715.277 60(8)*	22.31	0.207E-20	R(10) A	59	1718.279 74(11)*	1287.93	0.249E-22	R(61) B
25	1715.377 60(10)*	1038.59	0.686E-22	R(50) C	60	1718.354 72(14)*	1752.46	0.839E-23	R(66) D
26	1715.386 14(12)*	1459.26	0.286E-22	R(54) D	61	1718.425 82(11)*	1288.73	0.248E-22	R(61) C
27	1715.558 46(10)*	1058.74	0.634E-22	R(51) B	62	1718.538 48(11)*	1313.07	0.224E-22	R(62) B
28	1715.841 48(10)*	1079.84	0.584E-22	R(52) B	63	1718.575 80(8)*	77.08	0.288E-20	R(19) A
29	1715.907 32(13)*	1504.10	0.238E-22	R(56) D	64	1718.584 84(14)*	1779.51	0.747E-23	R(67) D
30	1715.953 16(10)*	1080.42	0.582E-22	R(52) C	65	1718.688 60(12)*	1313.90	0.223E-22	R(62) C
31	1716.027 78(8)*	31.64	0.233E-20	R(12) A	66	1718.794 77(11)*	1338.62	0.201E-22	R(63) B
32	1716.122 08(10)*	1101.34	0.536E-22	R(53) B	67	1718.929 93(8)*	85.19	0.291E-20	R(20) A
33	1716.163 97(13)*	1527.13	0.217E-22	R(57) D	68	1718.948 98(12)*	1339.47	0.200E-22	R(63) C
34	1716.237 41(10)*	1101.95	0.534E-22	R(53) C	69	1719.037 06(16)*	1834.81	0.588E-23	R(69) D
35	1716.399 18(8)*	36.92	0.245E-20	R(13) A	70	1719.048 60(12)*	1364.57	0.180E-22	R(64) B

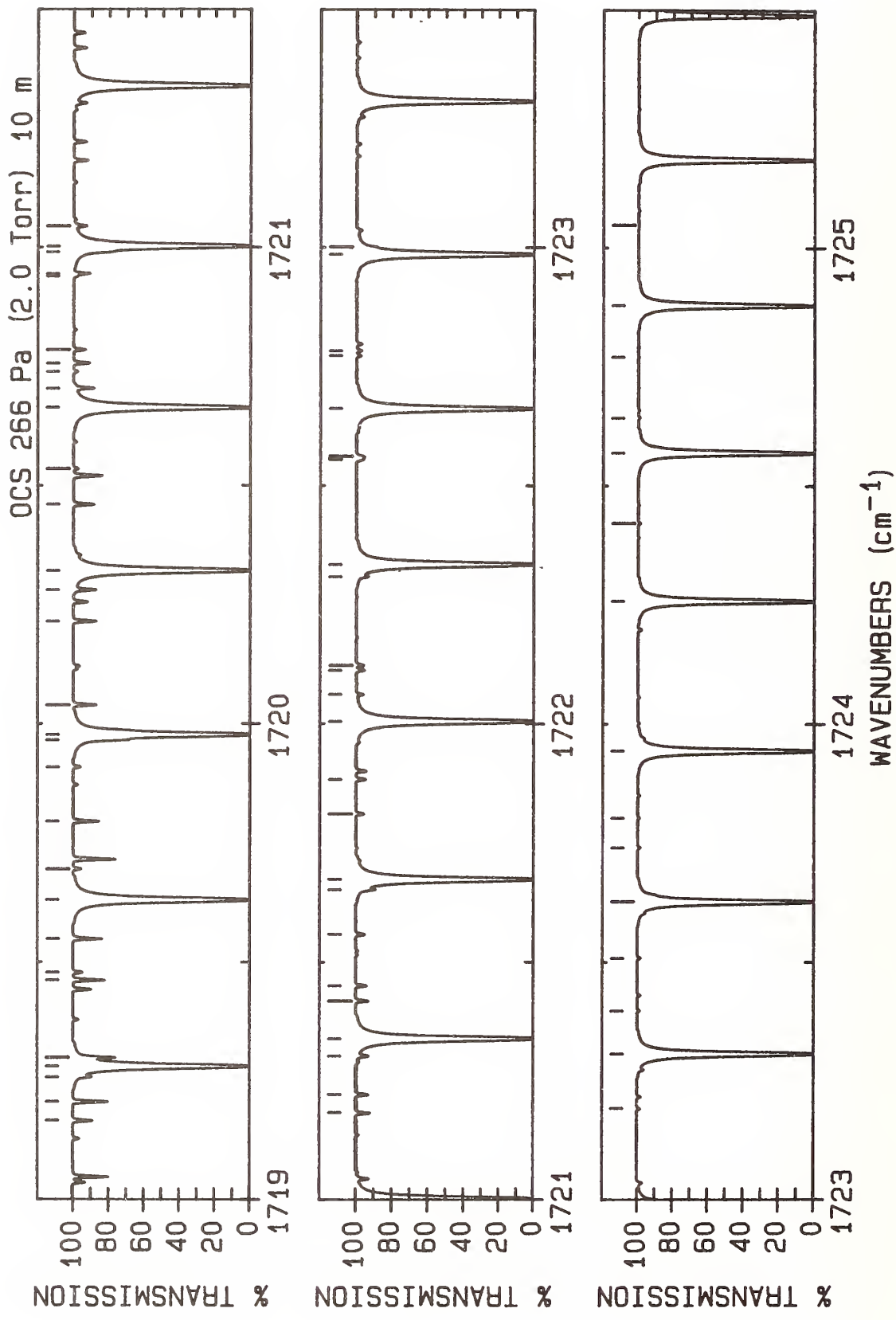

LINE #	WAVENUMBER(unc) (cm ⁻¹)	LOWER STATE (cm ⁻¹)	INTENSITY (cm/molecule)	ASSIGNMENT ROTATION BAND	LINE #	WAVENUMBER(unc) (cm ⁻¹)	LOWER STATE (cm ⁻¹)	INTENSITY (cm/molecule)	ASSIGNMENT ROTATION BAND
1	1719.167 12(15)	515.34	0.962E-23	R(50) T	36	1721.450 80(21)*	1646.29	0.528E-23	R(74) B
2	1719.206 94(13)*	1365.45	0.179E-22	R(64) C	37	1721.558 35(20)	715.26	0.429E-23	R(59) T
3	1719.259 14(17)*	1863.06	0.520E-23	R(70) D	38	1721.652 48(26)*	1647.46	0.525E-23	R(74) C
4	1719.281 58(8)*	93.71	0.293E-20	R(21) A	39	1721.673 64(8)*	164.69	0.274E-20	R(28) A
5	1719.299 97(12)*	1390.93	0.160E-22	R(65) B	40	1721.811 21(21)	739.49	0.387E-23	R(60) T
6	1719.462 48(14)*	1391.83	0.160E-22	R(65) C	41	1721.883 51(28)*	1677.89	0.459E-23	R(75) C
7	1719.478 54(18)*	1891.72	0.458E-23	R(71) D	42	1722.005 41(8)*	176.45	0.267E-20	R(29) A
8	1719.548 88(13)*	1417.69	0.143E-22	R(66) B	43	1722.061 49(22)	764.12	0.349E-23	R(61) T
9	1719.630 75(8)*	102.63	0.293E-20	R(22) A	44	1722.112 05(30)*	1708.71	0.400E-23	R(76) C
10	1719.695 25(20)*	1920.78	0.404E-23	R(72) D	45	1722.122 75(25)*	1738.67	0.350E-23	R(77) B
11	1719.795 32(13)*	1444.85	0.127E-22	R(67) B	46	1722.309 18(23)	789.15	0.314E-23	R(62) T
12	1719.909 27(22)*	1950.24	0.355E-23	R(73) D	47	1722.334 68(8)*	188.62	0.260E-20	R(30) A
13	1719.966 27(16)*	1445.81	0.127E-22	R(67) C	48	1722.554 28(25)	814.58	0.282E-23	R(63) T
14	1719.977 44(8)*	111.96	0.292E-20	R(23) A	49	1722.558 09(29)*	1802.28	0.264E-23	R(79) B
15	1720.039 28(14)*	1472.41	0.113E-22	R(68) B	50	1722.561 66(34)*	1771.58	0.303E-23	R(78) C
16	1720.214 52(17)*	1473.41	0.112E-22	R(68) C	51	1722.661 46(8)*	201.19	0.253E-20	R(31) A
17	1720.280 76(15)*	1500.39	0.100E-22	R(69) B	52	1722.771 97(31)*	1834.68	0.228E-23	R(80) B
18	1720.321 65(8)*	121.70	0.290E-20	R(24) A	53	1722.782 71(37)*	1803.61	0.262E-23	R(79) C
19	1720.460 32(18)*	1501.41	0.996E-23	R(69) C	54	1722.985 74(8)*	214.17	0.245E-20	R(32) A
20	1720.535 12(30)*	2041.03	0.238E-23	R(76) D	55	1723.001 25(39)*	1836.05	0.227E-23	R(80) C
21	1720.663 38(8)*	131.84	0.287E-20	R(25) A	56	1723.192 09(35)*	1900.71	0.170E-23	R(82) B
22	1720.703 67(19)*	1529.81	0.880E-23	R(70) C	57	1723.307 51(8)*	227.55	0.236E-20	R(33) A
23	1720.738 32(34)*	2072.09	0.207E-23	R(77) D	58	1723.398 32(38)*	1934.32	0.146E-23	R(83) B
24	1720.756 26(17)*	1557.54	0.780E-23	R(71) B	59	1723.508 72(33)	920.34	0.179E-23	R(67) T
25	1720.784 33(18)	644.99	0.573E-23	R(56) T	60	1723.626 78(8)*	241.34	0.228E-20	R(34) A
26	1720.938 80(38)*	2103.56	0.180E-23	R(78) D	61	1723.740 81(35)	947.79	0.159E-23	R(68) T
27	1720.944 57(21)*	1558.62	0.776E-23	R(71) C	62	1723.803 11(43)	2002.76	0.107E-23	R(85) B
28	1720.990 28(18)*	1586.72	0.686E-23	R(72) B	63	1723.943 54(8)*	255.53	0.219E-20	R(35) A
29	1721.002 62(8)*	142.38	0.284E-20	R(26) A	64	1724.257 78(8)*	270.13	0.209E-20	R(36) A
30	1721.044 90(18)	668.01	0.521E-23	R(57) T	65	1724.421 38(45)	1032.54	0.110E-23	R(71) T
31	1721.183 01(22)*	1587.83	0.683E-23	R(72) C	66	1724.569 52(8)*	285.13	0.200E-20	R(37) A
32	1721.221 79(19)*	1616.30	0.603E-23	R(73) B	67	1724.642 98(48)	1061.59	0.970E-24	R(72) T
33	1721.302 91(19)	691.43	0.473E-23	R(58) T	68	1724.770 06(58)	2180.89	0.477E-24	R(90) B
34	1721.339 38(8)*	153.34	0.279E-20	R(27) A	69	1724.878 74(8)*	300.54	0.190E-20	R(38) A
35	1721.418 98(24)*	1617.44	0.599E-23	R(73) C	70	1725.047 35(73)	2182.61	0.474E-24	R(90) C

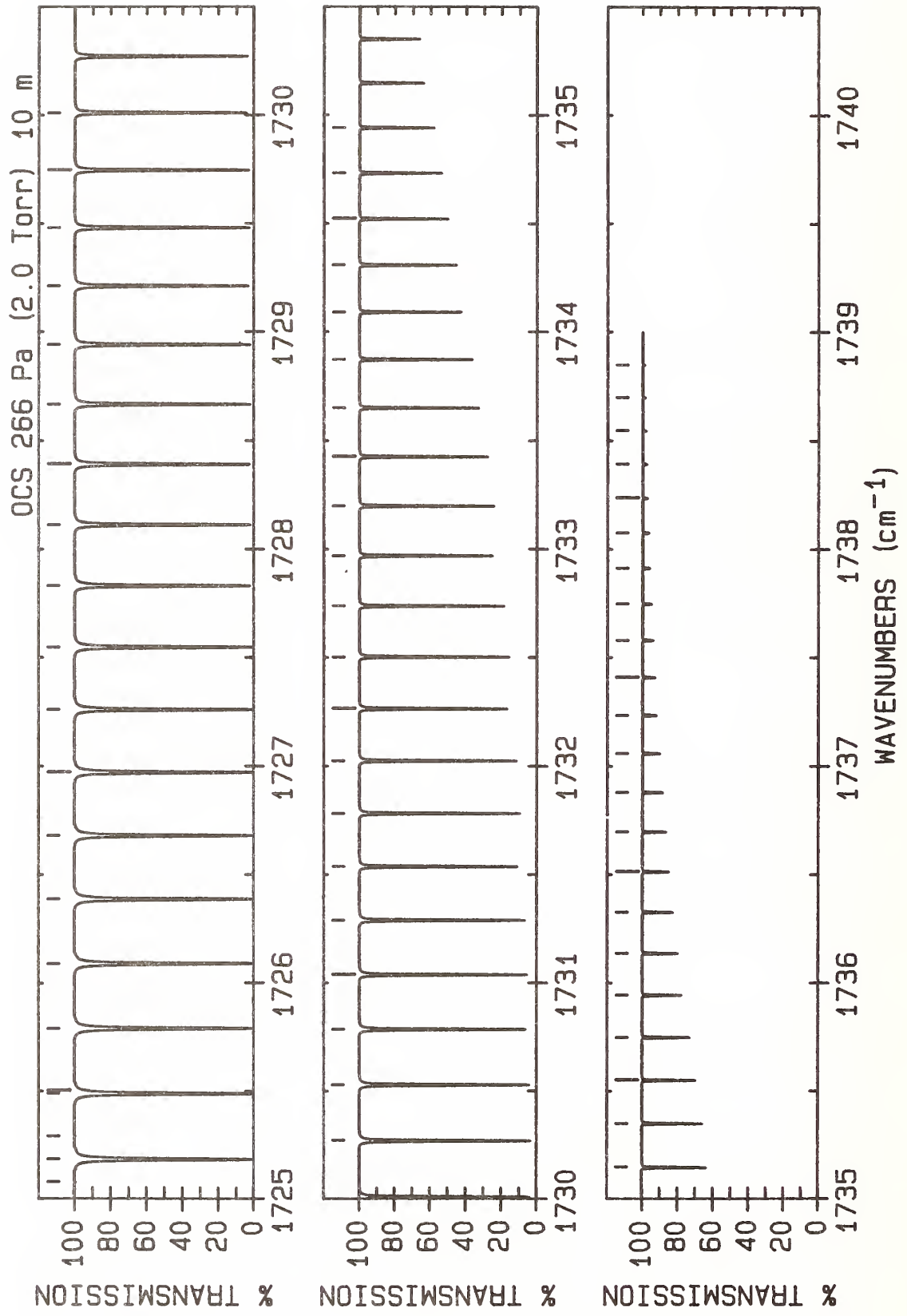

LINE #	WAVENUMBER(unc) (cm ⁻¹)	LOWER STATE (cm ⁻¹)	INTENSITY (cm/molecule)	ASSIGNMENT ROTATION BAND	LINE #	WAVENUMBER(unc) (cm ⁻¹)	LOWER STATE (cm ⁻¹)	INTENSITY (cm/molecule)	ASSIGNMENT ROTATION BAND
1	1725.078 28(56)	1120.90	0.747E-24	R(74) T	36	1733.650 89(8)*	1035.87	0.990E-22	R(71) A
2	1725.185 44(8)*	316.35	0.181E-20	R(39) A	37	1733.872 63(8)*	1065.02	0.872E-22	R(72) A
3	1725.291 97(61)	1151.16	0.654E-24	R(75) T	38	1734.091 73(8)*	1094.57	0.765E-22	R(73) A
4	1725.489 62(8)*	332.57	0.171E-20	R(40) A	39	1734.308 19(8)*	1124.52	0.671E-22	R(74) A
5	1725.503 02(65)	1181.82	0.571E-24	R(76) T	40	1734.522 00(8)*	1154.87	0.586E-22	R(75) A
6	1725.791 27(8)*	349.19	0.162E-20	R(41) A	41	1734.733 16(8)*	1185.63	0.512E-22	R(76) A
7	1726.090 40(8)*	366.22	0.153E-20	R(42) A	42	1734.941 67(8)*	1216.79	0.446E-22	R(77) A
8	1726.386 99(8)*	383.65	0.143E-20	R(43) A	43	1735.147 51(8)*	1248.35	0.387E-22	R(78) A
9	1726.681 05(8)*	401.49	0.135E-20	R(44) A	44	1735.350 70(8)*	1280.32	0.336E-22	R(79) A
10	1726.972 58(8)*	419.73	0.126E-20	R(45) A	45	1735.551 22(8)*	1312.69	0.290E-22	R(80) A
11	1727.261 56(8)*	438.37	0.118E-20	R(46) A	46	1735.749 06(8)*	1345.46	0.251E-22	R(81) A
12	1727.548 00(8)*	457.42	0.110E-20	R(47) A	47	1735.944 23(8)*	1378.63	0.216E-22	R(82) A
13	1727.831 90(8)*	476.88	0.102E-20	R(48) A	48	1736.136 72(8)*	1412.21	0.186E-22	R(83) A
14	1728.113 25(8)*	496.74	0.942E-21	R(49) A	49	1736.326 53(8)*	1446.18	0.159E-22	R(84) A
15	1728.392 04(8)*	517.00	0.871E-21	R(50) A	50	1736.513 65(8)*	1480.56	0.136E-22	R(85) A
16	1728.668 28(8)*	537.67	0.803E-21	R(51) A	51	1736.698 07(9)*	1515.34	0.117E-22	R(86) A
17	1728.941 96(8)*	558.74	0.739E-21	R(52) A	52	1736.879 79(9)*	1550.53	0.994E-23	R(87) A
18	1729.213 07(8)*	580.22	0.679E-21	R(53) A	53	1737.058 82(9)*	1586.11	0.846E-23	R(88) A
19	1729.481 62(8)*	602.10	0.622E-21	R(54) A	54	1737.235 13(10)*	1622.10	0.718E-23	R(89) A
20	1729.747 60(8)*	624.39	0.568E-21	R(55) A	55	1737.408 73(10)*	1658.48	0.608E-23	R(90) A
21	1730.011 01(8)*	647.08	0.518E-21	R(56) A	56	1737.579 62(11)*	1695.27	0.514E-23	R(91) A
22	1730.271 84(8)*	670.17	0.471E-21	R(57) A	57	1737.747 78(12)*	1732.46	0.434E-23	R(92) A
23	1730.530 09(8)*	693.67	0.427E-21	R(58) A	58	1737.913 22(13)*	1770.05	0.365E-23	R(93) A
24	1730.785 76(8)*	717.57	0.387E-21	R(59) A	59	1738.075 93(15)*	1808.05	0.307E-23	R(94) A
25	1731.038 84(8)*	741.87	0.350E-21	R(60) A	60	1738.235 91(16)*	1846.44	0.257E-23	R(95) A
26	1731.289 33(8)*	766.58	0.315E-21	R(61) A	61	1738.393 14(18)*	1885.23	0.215E-23	R(96) A
27	1731.537 23(8)*	791.70	0.284E-21	R(62) A	62	1738.547 63(20)*	1924.43	0.180E-23	R(97) A
28	1731.782 52(8)*	817.21	0.254E-21	R(63) A	63	1738.699 37(22)*	1964.03	0.150E-23	R(98) A
29	1732.025 22(8)*	843.13	0.228E-21	R(64) A	64	1738.848 36(24)*	2004.02	0.125E-23	R(99) A
30	1732.265 30(8)*	869.46	0.204E-21	R(65) A					
31	1732.502 78(8)*	896.18	0.182E-21	R(66) A					
32	1732.737 65(8)*	923.31	0.162E-21	R(67) A					
33	1732.969 90(8)*	950.85	0.143E-21	R(68) A					
34	1733.199 52(8)*	978.78	0.127E-21	R(69) A					
35	1733.426 52(8)*	1007.13	0.112E-21	R(70) A					



ATLAS OF OCS ABSORPTION LINES FROM 1832 cm⁻¹ to 1934 cm⁻¹

key:

Band	Isotopomer	Vibrational Transition
A	¹⁶ O ¹² C ³² S	02 ⁰ 1-00 ⁰ 0
B		03 ¹ 1-01 ^{1e} 0
C		03 ¹ 1-01 ^{1f} 0
D		02 ⁰ 2-00 ⁰ 1
E		04 ² 1-02 ^{2e} 0
F		04 ² 1-02 ^{2f} 0
G		04 ⁰ 1-02 ⁰ 0
H		03 ¹ 2-01 ^{1e} 1
I		03 ¹ 2-01 ^{1f} 1
X		02 ² 1-00 ⁰ 0
P	¹⁶ O ¹² C ³⁴ S	02 ⁰ 1-00 ⁰ 0
Q		03 ¹ 1-01 ^{1e} 0
R		03 ¹ 1-01 ^{1f} 0
T	¹⁶ O ¹³ C ³² S	02 ⁰ 1-00 ⁰ 0
U		03 ¹ 1-01 ^{1e} 0
V		03 ¹ 1-01 ^{1f} 0

If the e or f designation is not specified (for $l \neq 0$), then the transition is to either level, depending on the selection rules and the change in the rotational quantum number, J . Spectra are given for a slitwidth of 0.003 cm⁻¹, a temperature of 296 K, and a transition moment of 0.022 debye. No Herman-Wallis constant was included in the intensity calculation.

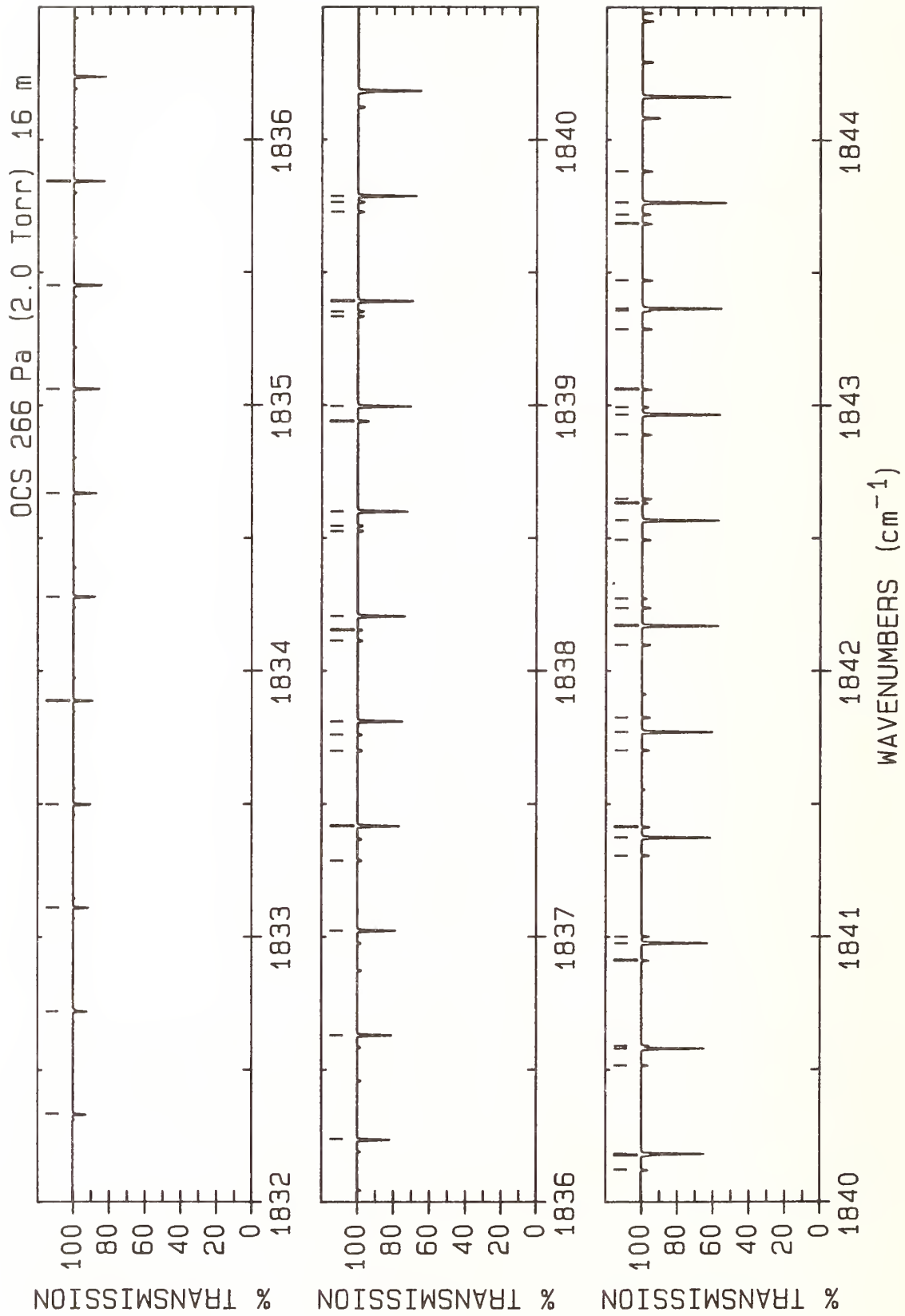

LINE #	WAVENUMBER(unc) (cm ⁻¹)	LOWER STATE (cm ⁻¹)	INTENSITY (cm/molecule)	ASSIGNMENT ROTATION BAND	LINE #	WAVENUMBER(unc) (cm ⁻¹)	LOWER STATE (cm ⁻¹)	INTENSITY (cm/molecule)	ASSIGNMENT ROTATION BAND
1	1832.333 60(39)	789.15	0.398E-23	P(62) T	36	1840.183 39(14)	365.04	0.222E-22	P(42) T
2	1832.721 70(36)	764.12	0.444E-23	P(61) T	37	1840.516 4	837.23	0.215E-23	P(40) V
3	1833.110 33(33)	739.49	0.494E-23	P(60) T	38	1840.580 00(13)	348.07	0.235E-22	P(41) T
4	1833.499 48(31)	715.26	0.548E-23	P(59) T	39	1840.589 6	820.69	0.227E-23	P(39) U
5	1833.889 13(28)	691.43	0.607E-23	P(58) T	40	1840.911 3	821.03	0.227E-23	P(39) V
6	1834.279 27(26)	668.01	0.670E-23	P(57) T	41	1840.976 91(12)	331.50	0.249E-22	P(40) T
7	1834.669 89(25)	644.99	0.739E-23	P(56) T	42	1841.001 7	804.91	0.239E-23	P(38) U
8	1835.060 99(23)	622.38	0.812E-23	P(55) T	43	1841.306 5	805.23	0.239E-23	P(38) V
9	1835.452 55(22)	600.16	0.890E-23	P(54) T	44	1841.374 14(12)	315.33	0.263E-22	P(39) T
10	1835.844 56(21)	578.35	0.974E-23	P(53) T	45	1841.413 7	789.54	0.251E-23	P(37) U
11	1836.237 01(20)	556.95	0.106E-22	P(52) T	46	1841.702 0	789.84	0.251E-23	P(37) V
12	1836.629 89(19)	535.94	0.116E-22	P(51) T	47	1841.771 67(11)	299.57	0.277E-22	P(38) T
13	1837.023 19(19)	515.34	0.125E-22	P(50) T	48	1841.825 5	774.57	0.263E-23	P(36) U
14	1837.286 7	961.47	0.138E-23	P(47) U	49	1842.097 8	774.86	0.262E-23	P(36) V
15	1837.416 90(18)	495.14	0.136E-22	P(49) T	50	1842.169 48(11)	284.21	0.291E-22	P(37) T
16	1837.700 1	942.46	0.148E-23	P(46) U	51	1842.237 1	760.00	0.274E-23	P(35) U
17	1837.760 3	961.95	0.138E-23	P(47) V	52	1842.272 39(35)	2103.56	0.148E-23	P(78) D
18	1837.811 00(17)	475.34	0.147E-22	P(48) T	53	1842.493 9	760.27	0.274E-23	P(35) V
19	1838.113 4	923.85	0.159E-23	P(45) U	54	1842.567 58(11)	269.26	0.305E-22	P(36) T
20	1838.153 1	942.92	0.148E-23	P(46) V	55	1842.632 64(32)	2072.09	0.171E-23	P(77) D
21	1838.205 49(17)	455.95	0.158E-22	P(47) T	56	1842.648 5	745.84	0.286E-23	P(34) U
22	1838.526 5	905.65	0.170E-23	P(44) U	57	1842.890 2	746.10	0.285E-23	P(34) V
23	1838.546 3	924.30	0.158E-23	P(45) V	58	1842.965 95(10)	254.71	0.318E-22	P(35) T
24	1838.600 36(16)	436.96	0.170E-22	P(46) T	59	1842.993 82(30)	2041.03	0.197E-23	P(76) D
25	1838.939 4	887.85	0.181E-23	P(43) U	60	1843.059 8	732.08	0.296E-23	P(33) U
26	1838.939 7	906.08	0.169E-23	P(44) V	61	1843.286 8	732.32	0.296E-23	P(33) V
27	1838.995 59(16)	418.38	0.183E-22	P(45) T	62	1843.355 92(28)*	2010.36	0.226E-23	P(75) D
28	1839.333 4	888.26	0.180E-23	P(43) V	63	1843.364 59(10)	240.56	0.331E-22	P(34) T
29	1839.352 2	870.45	0.192E-23	P(42) U	64	1843.470 9	718.73	0.307E-23	P(32) U
30	1839.391 18(15)	400.19	0.195E-22	P(44) T	65	1843.683 7	718.95	0.306E-23	P(32) V
31	1839.727 5	870.84	0.192E-23	P(42) V	66	1843.718 95(27)*	1980.10	0.260E-23	P(74) D
32	1839.764 8	853.46	0.204E-23	P(41) U	67	1843.763 48(10)	226.82	0.344E-22	P(33) T
33	1839.787 12(14)	382.42	0.208E-22	P(43) T	68	1843.881 8	705.77	0.316E-23	P(31) U
34	1840.121 8	853.84	0.203E-23	P(41) V					
35	1840.177 3	836.87	0.215E-23	P(40) U					

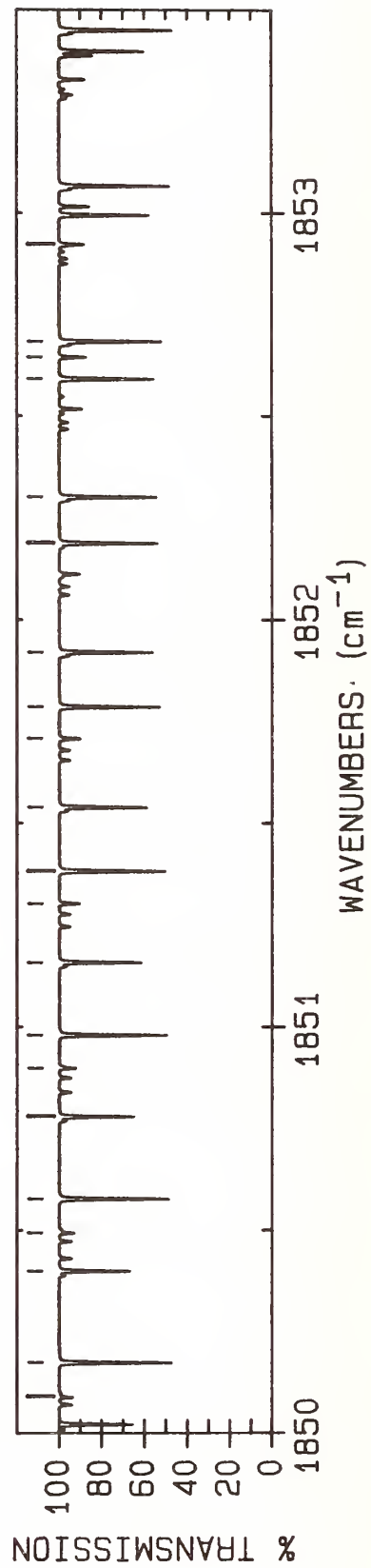
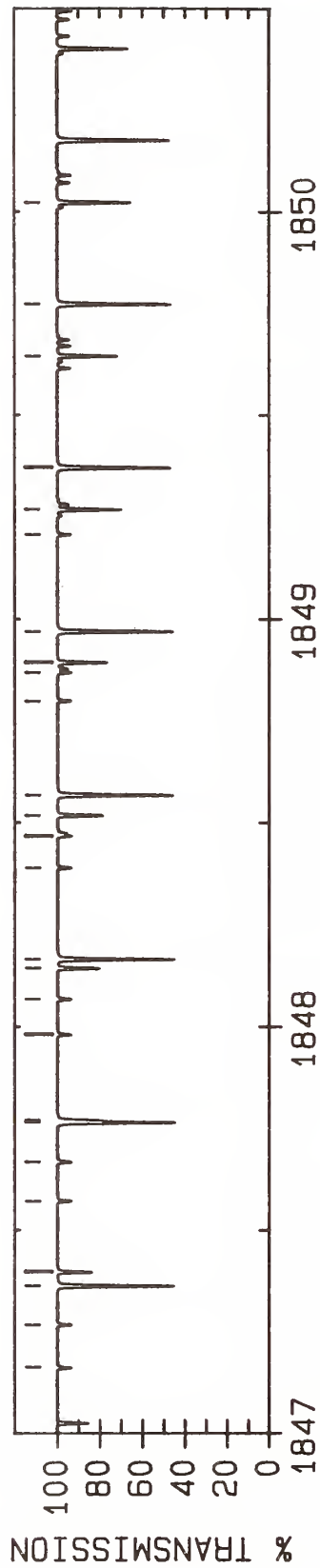
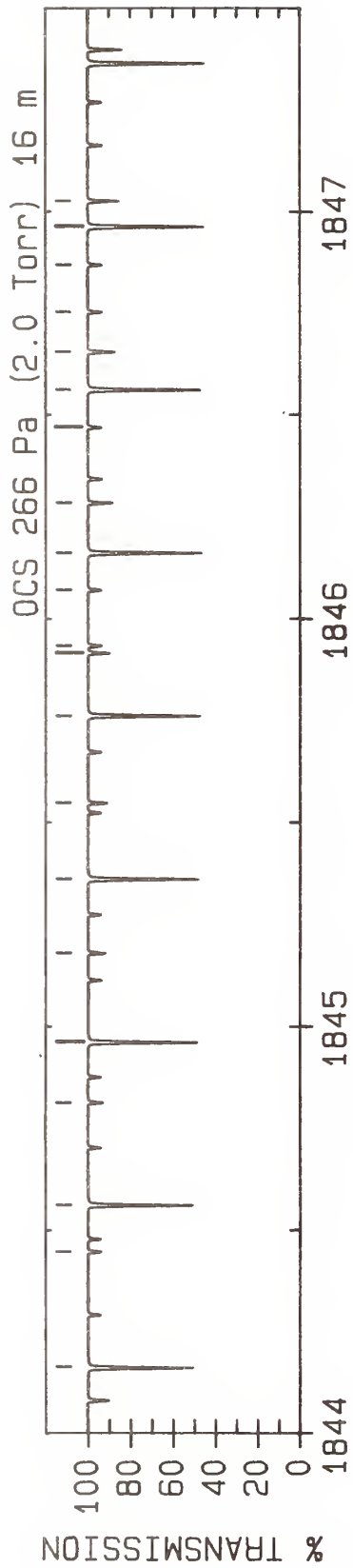

LINE #	WAVENUMBER(unc) (cm ⁻¹)	LOWER STATE (cm ⁻¹)	INTENSITY (cm/molecule)	ASSIGNMENT ROTATION BAND	LINE #	WAVENUMBER(unc) (cm ⁻¹)	LOWER STATE (cm ⁻¹)	INTENSITY (cm/molecule)	ASSIGNMENT ROTATION BAND
1	1844.162 63(10)	213.48	0.356E-22	P(32) T	36	1848.518 16(24)*	1623.25	0.126E-22	P(61) D
2	1844.447 72(25)*	1920.78	0.339E-23	P(72) D	37	1848.567 76(9)	93.41	0.421E-22	P(21) T
3	1844.562 02(10)	200.54	0.368E-22	P(31) T	38	1848.798 6	581.93	0.354E-23	P(19) U
4	1844.813 46(25)*	1891.72	0.387E-23	P(71) D	39	1848.868 5	582.01	0.354E-23	P(19) V
5	1844.961 64(10)	188.01	0.378E-22	P(30) T	40	1848.893 14(24)*	1598.62	0.140E-22	P(60) D
6	1845.180 09(25)*	1863.06	0.440E-23	P(70) D	41	1848.969 39(9)	84.92	0.418E-22	P(20) T
7	1845.361 49(10)	175.88	0.388E-22	P(29) T	42	1849.207 1	574.24	0.348E-23	P(18) U
8	1845.547 59(25)*	1834.81	0.499E-23	P(69) D	43	1849.268 89(24)*	1574.38	0.156E-22	P(59) D
9	1845.761 56(10)	164.16	0.397E-22	P(28) T	44	1849.269 2	574.31	0.348E-23	P(18) V
10	1845.915 97(24)*	1806.96	0.565E-23	P(68) D	45	1849.371 19(9)	76.83	0.413E-22	P(19) T
11	1845.933 7	647.09	0.353E-23	P(26) U	46	1849.645 41(24)*	1550.55	0.172E-22	P(58) D
12	1846.071 0	647.25	0.353E-23	P(26) V	47	1849.773 16(9)	69.15	0.406E-22	P(18) T
13	1846.161 85(10)	152.84	0.405E-22	P(27) T	48	1850.022 67(24)*	1527.13	0.190E-22	P(57) D
14	1846.285 21(24)*	1779.51	0.638E-23	P(67) D	49	1850.023 5	560.07	0.332E-23	P(16) U
15	1846.469 8	636.71	0.357E-23	P(25) V	50	1850.089 6	2018.52	0.350E-23	P(56) H
16	1846.562 35(10)	141.93	0.411E-22	P(26) T	51	1850.175 29(9)	61.87	0.398E-22	P(17) T
17	1846.655 30(24)*	1752.46	0.719E-23	P(66) D	52	1850.400 68(24)*	1504.10	0.209E-22	P(56) D
18	1846.753 2	626.45	0.361E-23	P(24) U	53	1850.493 9	1995.86	0.384E-23	P(55) H
19	1846.868 9	626.58	0.360E-23	P(24) V	54	1850.577 57(9)	55.00	0.387E-22	P(16) T
20	1846.963 05(10)	131.41	0.416E-22	P(25) T	55	1850.779 42(24)*	1481.48	0.230E-22	P(55) D
21	1847.026 23(24)*	1725.81	0.809E-23	P(65) D	56	1850.898 3	1973.61	0.420E-23	P(54) H
22	1847.162 6	616.74	0.362E-23	P(23) U	57	1850.980 02(9)	48.53	0.375E-22	P(15) T
23	1847.268 3	616.86	0.362E-23	P(23) V	58	1851.158 87(23)*	1459.26	0.252E-22	P(54) D
24	1847.363 94(10)	121.31	0.420E-22	P(24) T	59	1851.302 9	1951.77	0.459E-23	P(53) H
25	1847.397 99(24)*	1699.57	0.907E-23	P(64) D	60	1851.382 61(9)	42.46	0.360E-22	P(14) T
26	1847.571 9	607.43	0.363E-23	P(22) U	61	1851.539 02(23)*	1437.45	0.275E-22	P(53) D
27	1847.668 0	607.54	0.362E-23	P(22) V	62	1851.707 6	1930.32	0.500E-23	P(52) H
28	1847.765 03(10)	111.60	0.422E-22	P(23) T	63	1851.785 35(9)	36.80	0.344E-22	P(13) T
29	1847.770 58(24)*	1673.73	0.102E-22	P(63) D	64	1851.919 86(23)*	1416.04	0.300E-22	P(52) D
30	1847.981 0	598.52	0.361E-23	P(21) U	65	1852.188 23(9)	31.54	0.326E-22	P(12) T
31	1848.067 9	598.62	0.361E-23	P(21) V	66	1852.301 39(23)*	1395.03	0.326E-22	P(51) D
32	1848.143 97(24)*	1648.29	0.113E-22	P(62) D	67	1852.591 25(10)	26.69	0.306E-22	P(11) T
33	1848.166 31(9)	102.30	0.422E-22	P(22) T	68	1852.644 89(19)*	982.53	0.701E-23	P(70) P
34	1848.389 9	590.02	0.359E-23	P(20) U	69	1852.683 58(23)*	1374.42	0.354E-22	P(50) D
35	1848.468 1	590.11	0.359E-23	P(20) V	70	1852.922 5	1868.42	0.638E-23	P(49) H

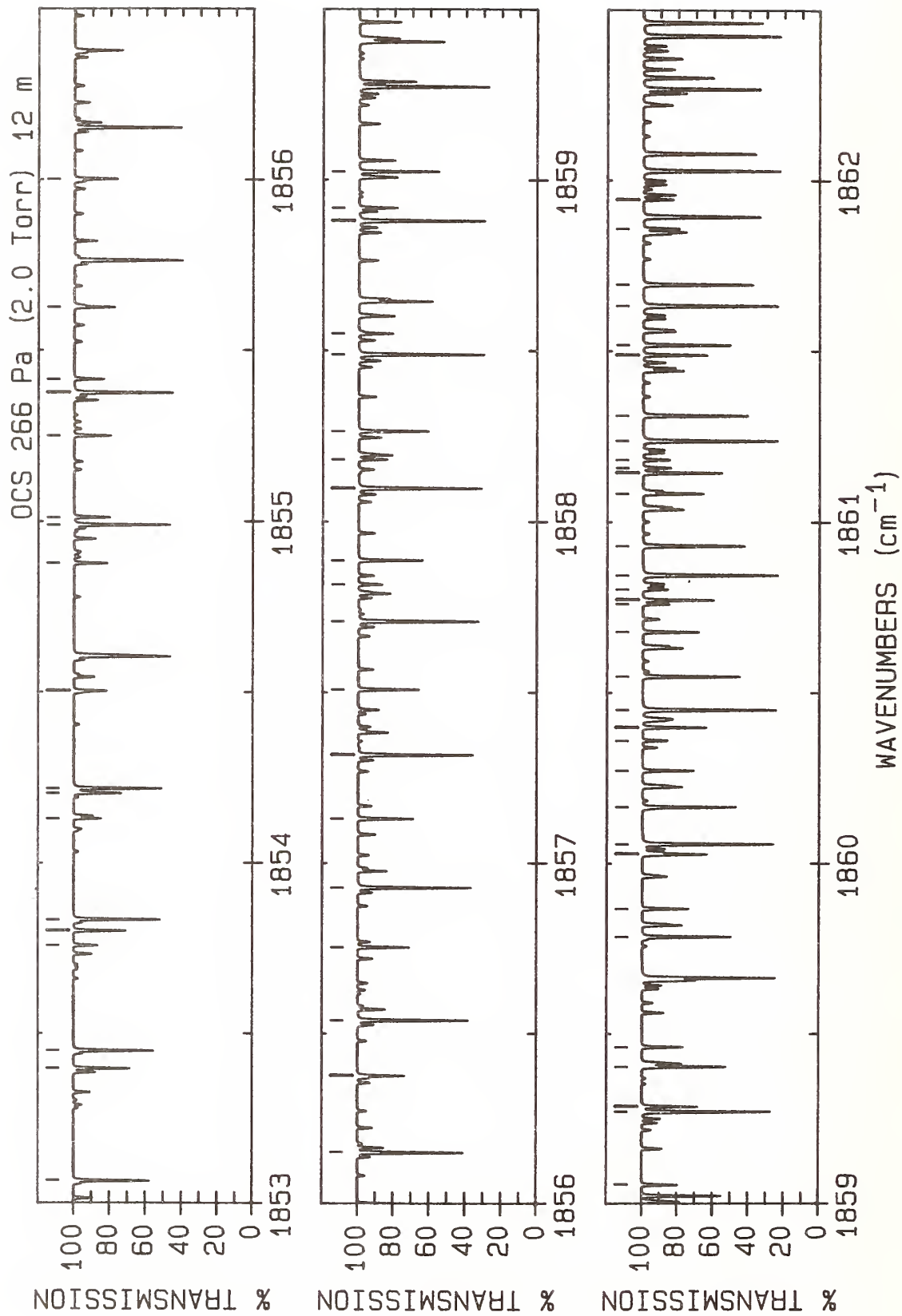

LINE #	WAVENUMBER(unc) (cm ⁻¹)	LOWER STATE (cm ⁻¹)	INTENSITY (cm/molecule)	ASSIGNMENT	ROTATION BAND	LINE #	WAVENUMBER(unc) (cm ⁻¹)	LOWER STATE (cm ⁻¹)	INTENSITY (cm/molecule)	ASSIGNMENT	ROTATION BAND
1	1853.066 43(23)*	1354.22	0.384E-22	P(49)	D	36	1858.918 38(9)*	1480.56	0.168E-22	P(85)	A
2	1853.397 70(10)	18.20	0.261E-22	P(9)	T	37	1859.024 14(18)*	566.04	0.415E-22	P(53)	P
3	1853.449 92(23)*	1334.42	0.414E-22	P(48)	D	38	1859.056 80(12)	4.04	0.156E-22	R(4)	T
4	1853.758 17(18)*	900.76	0.101E-22	P(67)	P	39	1859.272 00(23)*	1085.84	0.967E-22	P(33)	D
5	1853.801 13(11)	14.56	0.236E-22	P(8)	T	40	1859.287 45(9)*	1446.18	0.197E-22	P(84)	A
6	1853.834 04(23)*	1315.02	0.446E-22	P(47)	D	41	1859.404 29(18)*	545.09	0.452E-22	P(52)	P
7	1854.130 54(18)*	874.29	0.113E-22	P(66)	P	42	1859.461 89(11)	6.07	0.185E-22	R(5)	T
8	1854.204 68(11)	11.32	0.210E-22	P(7)	T	43	1859.784 92(18)*	524.53	0.490E-22	P(51)	P
9	1854.218 79(23)*	1296.03	0.480E-22	P(46)	D	44	1859.867 10(11)	8.49	0.213E-22	R(6)	T
10	1854.503 52(18)*	848.22	0.126E-22	P(65)	P	45	1860.027 91(9)*	1378.63	0.269E-22	P(82)	A
11	1854.877 12(18)*	822.54	0.141E-22	P(64)	P	46	1860.057 12(23)*	1059.56	0.103E-21	P(31)	D
12	1854.990 09(23)*	1259.25	0.550E-22	P(44)	D	47	1860.166 02(18)*	504.37	0.531E-22	P(50)	P
13	1855.012 17(12)	6.07	0.154E-22	P(5)	T	48	1860.272 42(10)	11.32	0.241E-22	R(7)	T
14	1855.251 31(18)*	797.25	0.158E-22	P(63)	P	49	1860.360 71(9)	966.45	0.107E-22	P(47)	Q
15	1855.376 63(23)*	1241.47	0.587E-22	P(43)	D	50	1860.399 29(9)*	1345.46	0.313E-22	P(81)	A
16	1855.416 10(12)	4.04	0.124E-22	P(4)	T	51	1860.450 37(23)*	1047.02	0.106E-21	P(30)	D
17	1855.626 10(18)*	772.36	0.176E-22	P(62)	P	52	1860.547 59(18)*	484.60	0.573E-22	P(49)	P
18	1856.001 47(18)*	747.86	0.195E-22	P(61)	P	53	1860.677 86(10)	14.56	0.267E-22	R(8)	T
19	1856.151 43(23)*	1207.11	0.662E-22	P(41)	D	54	1860.759 84(9)	947.84	0.114E-22	P(46)	Q
20	1856.377 41(18)*	723.75	0.216E-22	P(60)	P	55	1860.771 43(9)*	1312.69	0.364E-22	P(80)	A
21	1856.539 66(23)*	1190.54	0.701E-22	P(40)	D	56	1860.802 34(10)	966.90	0.107E-22	P(47)	R
22	1856.753 91(18)*	700.04	0.239E-22	P(59)	P	57	1860.844 08(23)*	1034.89	0.109E-21	P(29)	D
23	1856.928 44(23)*	1174.37	0.740E-22	P(39)	D	58	1860.929 61(18)*	465.23	0.618E-22	P(48)	P
24	1857.130 96(18)*	676.72	0.264E-22	P(58)	P	59	1861.083 41(10)	18.20	0.291E-22	R(9)	T
25	1857.317 76(23)*	1158.61	0.779E-22	P(38)	D	60	1861.144 33(9)*	1280.32	0.422E-22	P(79)	A
26	1857.508 55(18)*	653.80	0.290E-22	P(57)	P	61	1861.158 97(9)	929.63	0.122E-22	P(45)	Q
27	1857.707 59(23)*	1143.24	0.818E-22	P(37)	D	62	1861.182 44(9)	948.28	0.114E-22	P(46)	R
28	1857.815 86(9)*	1586.11	0.103E-22	P(88)	A	63	1861.238 24(23)*	1023.17	0.112E-21	P(28)	D
29	1857.886 67(18)*	631.27	0.318E-22	P(56)	P	64	1861.312 07(18)*	446.25	0.664E-22	P(47)	P
30	1858.097 95(23)*	1128.29	0.856E-22	P(36)	D	65	1861.489 08(9)	22.24	0.314E-22	R(10)	T
31	1858.182 58(9)*	1550.53	0.121E-22	P(87)	A	66	1861.517 97(9)*	1248.35	0.489E-22	P(78)	A
32	1858.265 32(18)*	609.13	0.349E-22	P(55)	P	67	1861.632 83(23)*	1011.84	0.114E-21	P(27)	D
33	1858.488 81(23)*	1113.73	0.894E-22	P(35)	D	68	1861.694 97(18)*	427.66	0.712E-22	P(46)	P
34	1858.550 09(9)*	1515.34	0.143E-22	P(86)	A	69	1861.858 76(14)*	1616.30	0.161E-22	P(73)	B
35	1858.880 16(23)*	1099.58	0.931E-22	P(34)	D	70	1861.943 88(9)	912.21	0.130E-22	P(44)	R

OCS 266 Pa (2.0 Torr) 2 m

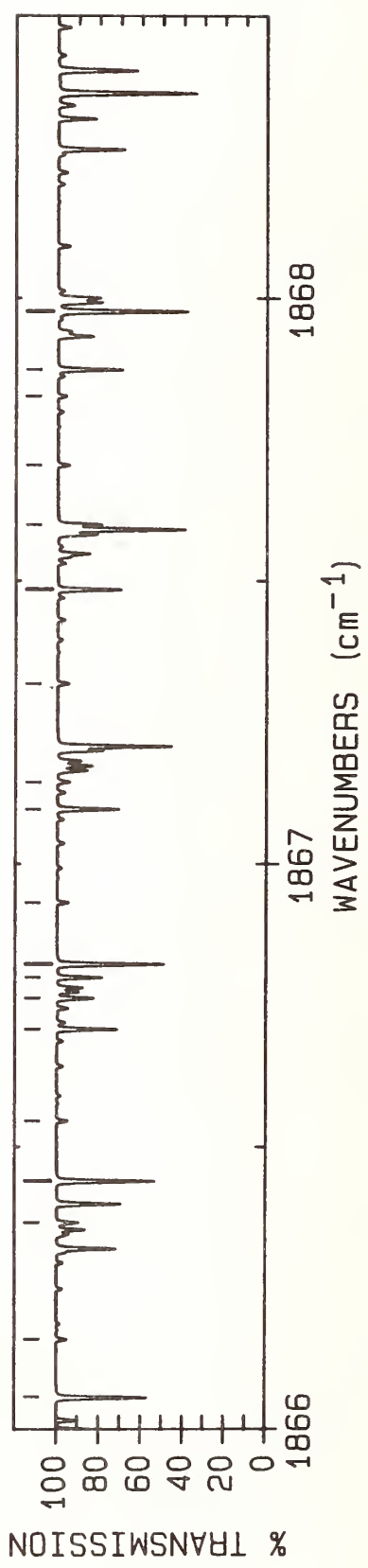
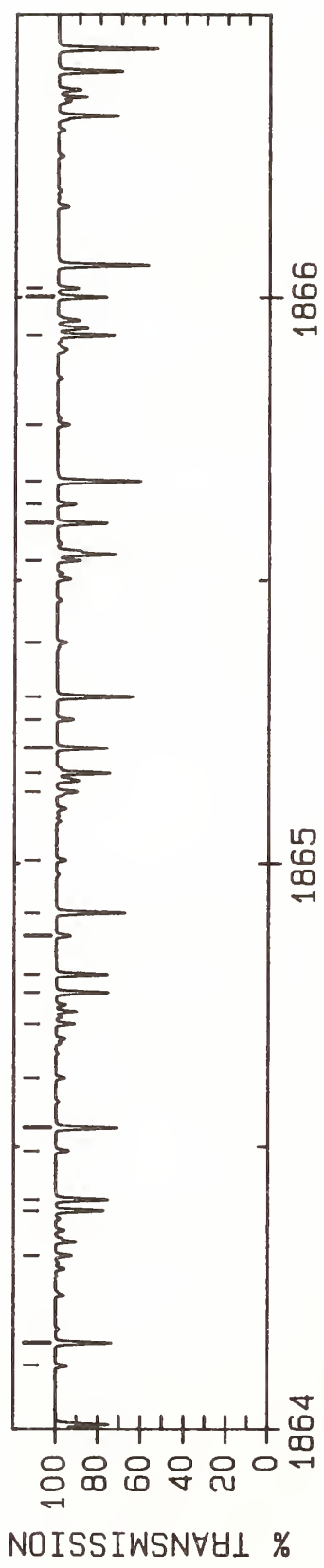
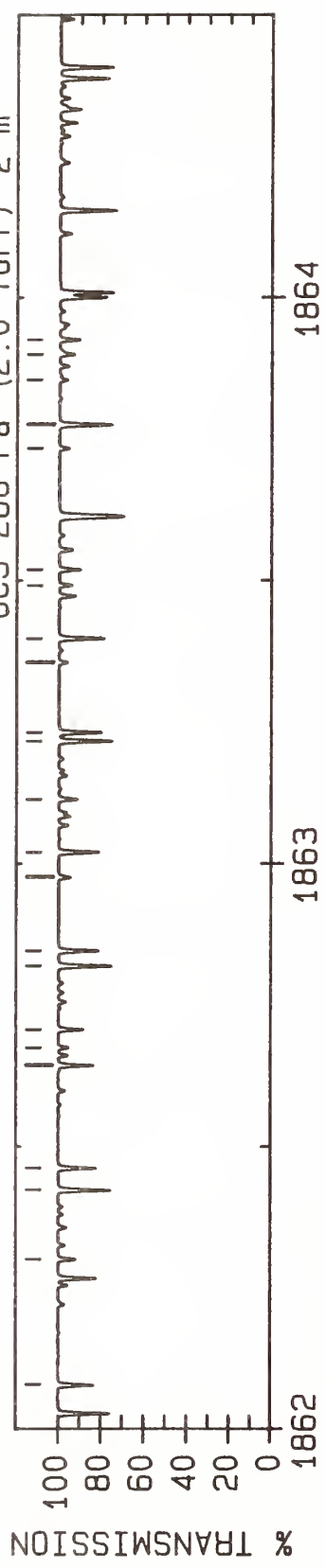

LINE #	WAVENUMBER(unc) (cm ⁻¹)	LOWER STATE (cm ⁻¹)	INTENSITY (cm/molecule)	ASSIGNMENT ROTATION BAND	LINE #	WAVENUMBER(unc) (cm ⁻¹)	LOWER STATE (cm ⁻¹)	INTENSITY (cm/molecule)	ASSIGNMENT ROTATION BAND
1	1862.078 29(18)*	409.47	0.762E-22	P(45)	36	1864.913 14(9)*	978.78	0.165E-21	P(69)
2	1862.300 77(9)	31.54	0.355E-22	R(12)	37	1865.005 51(7)	783.77	0.199E-22	R(36)
3	1862.423 31(23)*	990.41	0.117E-21	P(25)	38	1865.126 30(13)*	1390.93	0.433E-22	P(65)
4	1862.462 03(18)*	391.68	0.813E-22	P(44)	39	1865.159 12(18)*	278.16	0.119E-21	P(37)
5	1862.643 31(9)*	1154.87	0.748E-22	P(75)	40	1865.202 82(23)*	928.13	0.114E-21	P(18)
6	1862.674 61(13)*	1557.54	0.209E-22	P(71)	41	1865.253 77(13)*	1445.81	0.342E-22	P(67)
7	1862.706 79(9)	36.80	0.373E-22	R(13)	42	1865.293 83(9)*	950.85	0.186E-21	P(68)
8	1862.819 17(23)*	980.30	0.118E-21	P(24)	43	1865.389 96(7)	769.50	0.208E-22	P(35)
9	1862.846 17(18)*	374.27	0.865E-22	P(43)	44	1865.535 40(13)*	1364.57	0.485E-22	P(64)
10	1862.976 03(13)*	1617.44	0.161E-22	P(73)	45	1865.601 45(23)*	920.85	0.112E-21	P(17)
11	1863.019 87(9)*	1124.52	0.857E-22	P(74)	46	1865.635 02(13)*	1418.62	0.385E-22	P(66)
12	1863.112 93(9)	42.46	0.389E-22	R(14)	47	1865.675 18(9)*	923.31	0.210E-21	P(67)
13	1863.215 46(23)*	970.60	0.119E-21	P(23)	48	1865.774 80(7)	755.63	0.216E-22	P(34)
14	1863.230 72(18)*	357.27	0.919E-22	P(42)	49	1865.932 98(18)*	249.29	0.130E-21	P(35)
15	1863.354 47(13)*	1587.83	0.184E-22	P(72)	50	1866.000 45(23)*	913.98	0.109E-21	P(16)
16	1863.397 14(9)*	1094.57	0.981E-22	P(73)	51	1866.016 74(13)*	1391.83	0.432E-22	P(65)
17	1863.491 21(13)*	1500.39	0.269E-22	P(69)	52	1866.057 17(9)*	896.18	0.237E-21	P(66)
18	1863.519 19(9)	48.53	0.402E-22	R(15)	53	1866.160 02(7)	742.14	0.224E-22	P(33)
19	1863.733 39(13)*	1558.62	0.209E-22	P(71)	54	1866.366 62(10)	102.30	0.446E-22	R(22)
20	1863.775 11(9)*	1065.02	0.112E-21	P(72)	55	1866.439 80(9)*	869.46	0.266E-21	P(65)
21	1863.854 46(8)	828.97	0.173E-22	P(39)	56	1866.545 61(6)	729.06	0.231E-22	P(32)
22	1863.899 77(13)*	1472.41	0.304E-22	P(68)	57	1866.708 19(18)*	221.99	0.140E-21	P(33)
23	1863.925 58(9)	55.00	0.414E-22	R(16)	58	1866.763 34(13)*	1287.93	0.672E-22	P(61)
24	1864.112 78(13)*	1529.81	0.237E-22	P(70)	59	1866.799 56(24)*	901.44	0.101E-21	P(14)
25	1864.153 77(9)*	1035.87	0.128E-21	P(71)	60	1866.823 05(9)*	843.13	0.299E-21	P(64)
26	1864.308 47(13)*	1444.85	0.343E-22	P(67)	61	1866.931 57(6)	716.37	0.239E-22	P(31)
27	1864.386 65(18)*	308.62	0.108E-21	P(39)	62	1867.096 27(18)*	208.93	0.145E-21	P(32)
28	1864.406 71(23)*	943.90	0.117E-21	P(20)	63	1867.143 91(6)	703.89	0.245E-22	P(30)
29	1864.492 64(13)*	1501.41	0.269E-22	P(69)	64	1867.317 91(6)	704.08	0.245E-22	P(30)
30	1864.533 12(9)*	1007.13	0.145E-21	P(70)	65	1867.484 68(18)*	196.27	0.149E-21	P(31)
31	1864.621 44(8)	798.44	0.191E-22	P(37)	66	1867.600 10(24)*	890.52	0.915E-22	P(12)
32	1864.717 32(13)*	1417.69	0.386E-22	P(66)	67	1867.704 62(6)	692.18	0.251E-22	P(29)
33	1864.772 71(18)*	293.19	0.114E-21	P(38)	68	1867.826 17(17)	1673.42	0.184E-22	P(55)
34	1864.804 57(23)*	935.82	0.116E-21	P(19)	69	1867.873 38(18)*	184.01	0.153E-21	P(30)
35	1864.872 97(13)*	1473.41	0.304E-22	P(68)	70	1867.976 47(9)*	766.58	0.416E-21	P(61)

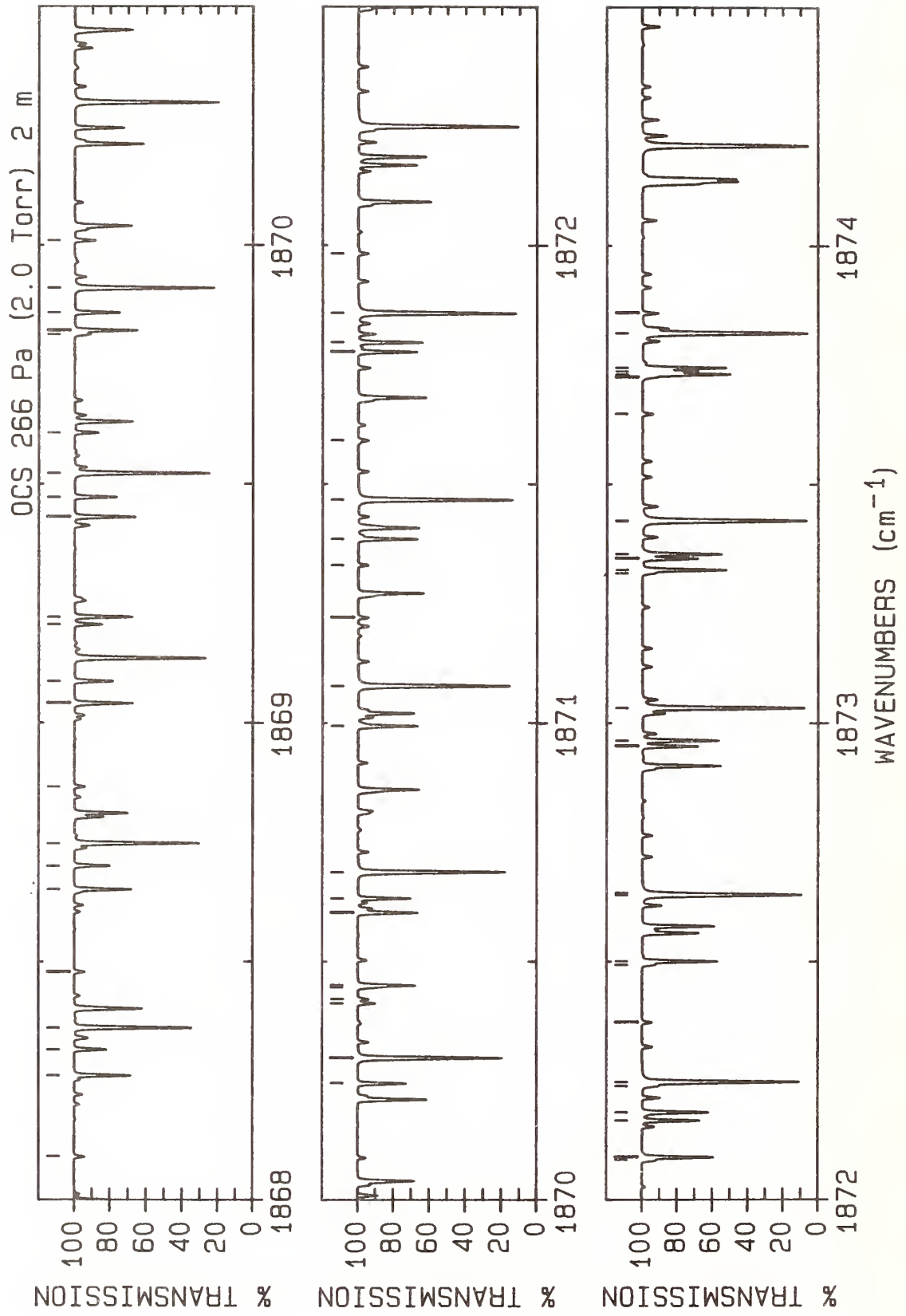

LINE #	WAVENUMBER(unc) (cm ⁻¹)	LOWER STATE (cm ⁻¹)	INTENSITY (cm/molecule)	ASSIGNMENT ROTATION BAND	LINE #	WAVENUMBER(unc) (cm ⁻¹)	LOWER STATE (cm ⁻¹)	INTENSITY (cm/molecule)	ASSIGNMENT ROTATION BAND
1	1868.091 70(6)	680.68	0.257E-22	P(28) R	36	1871.329 76(20)	1519.78	0.258E-22	P(48) E
2	1868.262 39(18)*	172.14	0.157E-21	P(29) P	37	1871.384 60(19)*	91.42	0.169E-21	P(21) P
3	1868.316 61(13)*	1239.61	0.825E-22	P(59) C	38	1871.467 15(9)*	558.74	0.986E-21	P(52) A
4	1868.362 12(9)*	741.87	0.462E-21	P(60) A	39	1871.591 65(8)	595.02	0.264E-22	P(19) R
5	1868.479 15(6)	669.58	0.261E-22	P(27) R	40	1871.776 06(19)*	83.11	0.167E-21	P(20) P
6	1868.651 70(18)*	160.67	0.160E-21	P(28) P	41	1871.796 19(13)*	1038.59	0.186E-21	P(50) C
7	1868.701 49(13)*	1215.65	0.911E-22	P(58) C	42	1871.857 60(9)*	537.67	0.107E-20	P(51) A
8	1868.748 35(9)*	717.57	0.512E-21	P(59) A	43	1871.982 31(9)	587.48	0.259E-22	P(18) R
9	1868.866 95(6)	658.87	0.265E-22	P(26) R	44	1872.083 99(11)	269.26	0.318E-22	R(36) T
10	1869.041 29(18)*	149.59	0.163E-21	P(27) P	45	1872.090 79(13)*	997.88	0.218E-21	P(48) B
11	1869.086 81(13)*	1192.10	0.101E-21	P(57) C	46	1872.167 77(19)*	75.19	0.165E-21	P(19) P
12	1869.205 40(24)*	873.53	0.663E-22	P(8) D	47	1872.184 95(13)*	1018.28	0.202E-21	P(49) C
13	1869.221 07(10)	175.88	0.406E-22	R(29) T	48	1872.240 04(20)	1481.18	0.300E-22	P(46) F
14	1869.221 34(13)*	1145.56	0.122E-21	P(55) B	49	1872.248 53(9)*	517.00	0.116E-20	P(50) A
15	1869.431 16(18)*	138.90	0.166E-21	P(26) P	50	1872.373 31(9)	580.35	0.254E-22	P(17) R
16	1869.472 57(13)*	1168.96	0.111E-21	P(56) C	51	1872.493 78(12)	284.21	0.303E-22	R(37) T
17	1869.522 49(9)*	670.17	0.625E-21	P(57) A	52	1872.500 75(13)*	978.40	0.235E-21	P(47) B
18	1869.607 58(24)*	870.29	0.589E-22	P(7) D	53	1872.639 93(9)*	496.74	0.126E-20	P(49) A
19	1869.812 49(17)	1565.68	0.285E-22	P(50) G	54	1872.644 58(20)	1462.47	0.321E-22	P(45) F
20	1869.821 32(18)*	128.62	0.168E-21	P(25) P	55	1872.951 91(19)*	60.55	0.159E-21	P(17) P
21	1869.858 76(13)*	1146.22	0.121E-21	P(55) C	56	1872.963 71(13)*	978.88	0.234E-21	P(47) C
22	1869.910 38(9)*	647.08	0.688E-21	P(56) A	57	1873.031 78(9)*	476.88	0.136E-20	P(48) A
23	1870.010 10(24)*	867.46	0.512E-22	P(6) D	58	1873.314 03(13)	315.33	0.274E-22	R(39) T
24	1870.245 39(13)*	1123.88	0.133E-21	P(54) C	59	1873.320 65(13)*	940.66	0.270E-21	P(45) B
25	1870.298 80(9)*	624.39	0.755E-21	P(55) A	60	1873.344 34(19)*	53.83	0.155E-21	P(16) P
26	1870.412 95(25)*	865.03	0.432E-22	P(5) D	61	1873.353 71(13)*	959.78	0.252E-21	P(46) C
27	1870.421 79(7)	620.01	0.271E-22	P(22) R	62	1873.423 37(17)	1397.33	0.534E-22	P(41) G
28	1870.446 90(10)	213.48	0.372E-22	R(32) T	63	1873.424 09(9)*	457.42	0.147E-20	P(47) A
29	1870.450 99(13)*	1079.84	0.158E-21	P(52) B	64	1873.647 65(25)*	860.18	0.266E-22	R(2) D
30	1870.602 43(18)*	109.23	0.170E-21	P(23) P	65	1873.724 49(14)	331.50	0.259E-22	R(40) T
31	1870.632 45(13)*	1101.95	0.145E-21	P(53) C	66	1873.730 58(13)*	922.39	0.289E-21	P(44) B
32	1870.687 75(9)*	602.10	0.827E-21	P(54) A	67	1873.737 00(19)*	47.49	0.150E-21	P(15) P
33	1870.993 39(18)*	100.13	0.170E-21	P(22) P	68	1873.744 13(13)*	941.10	0.270E-21	P(45) C
34	1871.077 20(9)*	580.22	0.905E-21	P(53) A	69	1873.816 84(9)*	438.37	0.158E-20	P(46) A
35	1871.219 66(25)*	861.39	0.264E-22	P(3) D	70	1873.858 86(20)	1408.78	0.389E-22	P(42) F

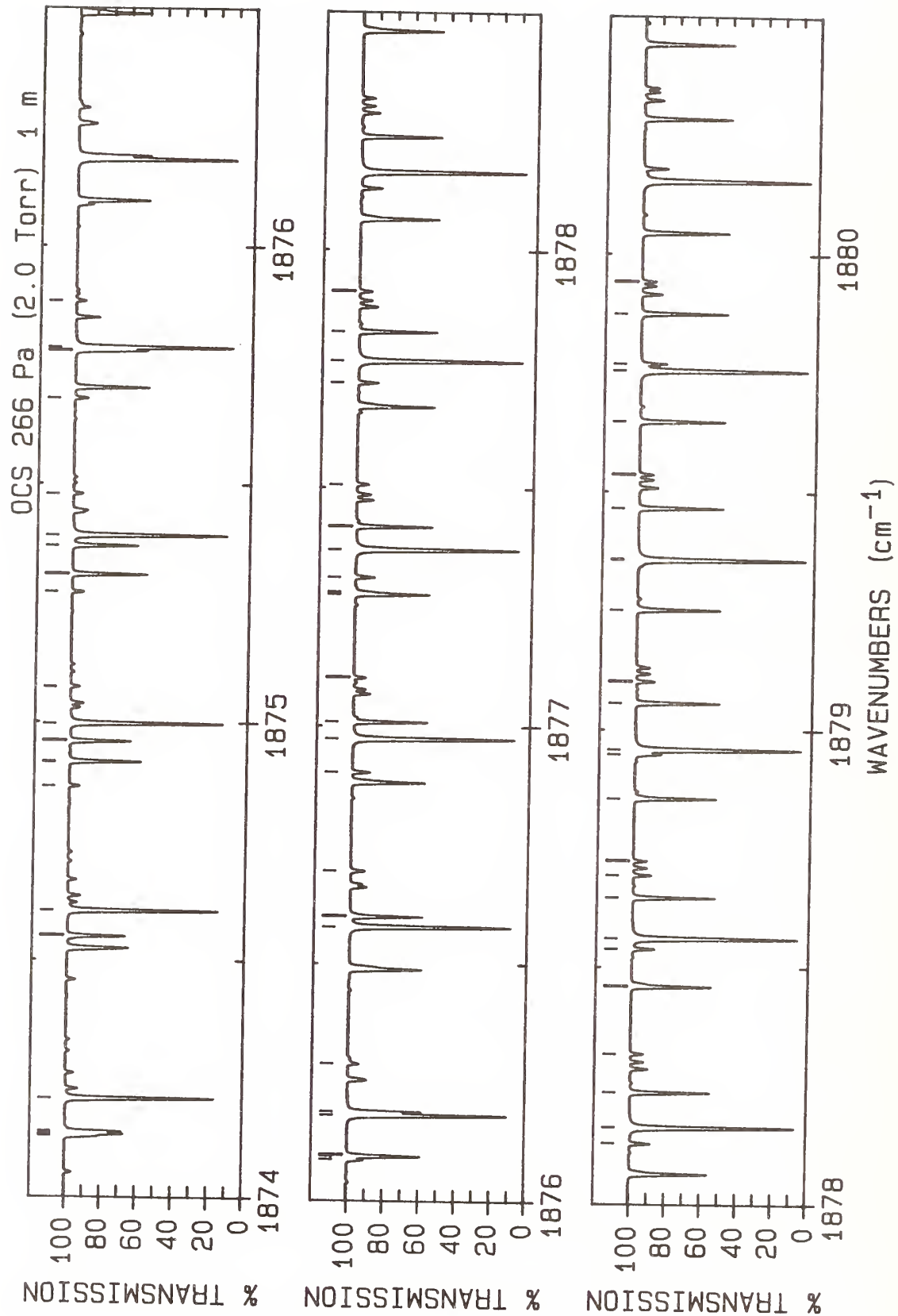

LINE #	WAVENUMBER(unc) (cm ⁻¹)	LOWER STATE (cm ⁻¹)	INTENSITY (cm/molecule)	ASSIGNMENT ROTATION BAND	LINE #	WAVENUMBER(unc) (cm ⁻¹)	LOWER STATE (cm ⁻¹)	INTENSITY (cm/molecule)	ASSIGNMENT ROTATION BAND
1	1874.129 88(19)*	41.56	0.144E-21	P(14)	36	1877.275 89(13)*	791.16	0.449E-21	P(36)
2	1874.134 95(13)*	922.82	0.289E-21	P(44)	37	1877.280 80(20)*	8.31	0.725E-22	P(6)
3	1874.140 48(13)*	904.54	0.308E-21	P(43)	38	1877.311 55(24)*	885.66	0.942E-22	R(11)
4	1874.210 02(9)*	419.73	0.169E-20	P(45)	39	1877.369 92(9)*	285.13	0.269E-20	P(37)
5	1874.550 36(13)*	887.08	0.328E-21	P(42)	40	1877.418 47(13)*	776.26	0.469E-21	P(35)
6	1874.603 63(9)*	401.49	0.181E-20	P(44)	41	1877.506 78(19)	1269.63	0.602E-22	F
7	1874.866 03(24)*	865.03	0.520E-22	R(5)	42	1877.720 28(24)*	890.52	0.996E-22	R(12)
8	1874.916 33(19)*	30.87	0.130E-21	P(12)	43	1877.766 58(9)*	270.13	0.281E-20	P(36)
9	1874.917 80(13)*	887.47	0.327E-21	P(42)	44	1877.828 00(13)*	762.05	0.488E-21	P(34)
10	1874.960 21(13)*	870.04	0.348E-21	P(41)	45	1877.912 52(19)	1256.20	0.623E-22	F
11	1874.997 64(9)*	383.65	0.193E-20	P(43)	46	1878.129 34(24)*	895.77	0.105E-21	R(13)
12	1875.074 04(19)	1358.74	0.461E-22	P(39)	47	1878.163 59(9)*	255.53	0.294E-20	P(35)
13	1875.272 80(24)*	867.46	0.599E-22	R(6)	48	1878.237 47(13)*	748.25	0.507E-21	P(33)
14	1875.309 83(13)*	870.40	0.347E-21	P(41)	49	1878.318 33(19)	1243.18	0.644E-22	P(31)
15	1875.309 88(19)*	26.12	0.122E-21	P(11)	50	1878.460 17(13)*	748.49	0.506E-21	P(33)
16	1875.370 03(13)*	853.39	0.368E-21	P(40)	51	1878.538 74(23)*	901.44	0.109E-21	R(14)
17	1875.392 06(9)*	366.22	0.205E-20	P(42)	52	1878.560 93(9)*	241.34	0.306E-20	P(34)
18	1875.479 28(19)	1342.87	0.486E-22	P(38)	53	1878.646 88(13)*	734.85	0.525E-21	P(32)
19	1875.679 90(24)*	870.29	0.676E-22	R(7)	54	1878.693 95(17)	1212.24	0.904E-22	P(28)
20	1875.779 81(13)*	837.16	0.388E-21	P(39)	55	1878.724 21(19)	1230.57	0.662E-22	F
21	1875.786 88(9)*	349.19	0.218E-20	P(41)	56	1878.855 69(13)*	735.07	0.524E-21	C
22	1875.884 62(19)	1327.41	0.510E-22	P(37)	57	1878.948 47(23)*	907.50	0.113E-21	R(15)
23	1876.087 32(24)*	873.53	0.749E-22	R(8)	58	1878.958 61(9)*	227.55	0.318E-20	P(33)
24	1876.095 08(13)*	837.49	0.388E-21	P(39)	59	1879.056 23(13)*	721.86	0.542E-21	P(31)
25	1876.097 62(19)*	17.81	0.104E-21	P(9)	60	1879.101 01(17)	1200.85	0.922E-22	G
26	1876.182 08(9)*	332.57	0.230E-20	P(40)	61	1879.251 59(13)*	722.07	0.541E-21	C
27	1876.189 54(13)*	821.33	0.409E-21	P(38)	62	1879.356 61(9)*	214.17	0.329E-20	P(32)
28	1876.290 04(19)	1312.36	0.534E-22	P(36)	63	1879.358 55(23)*	913.98	0.116E-21	R(16)
29	1876.577 66(9)*	316.35	0.243E-20	P(39)	64	1879.465 50(13)*	709.27	0.557E-21	P(30)
30	1876.599 24(13)*	805.90	0.429E-21	P(37)	65	1879.536 17(19)	1206.55	0.694E-22	F
31	1876.695 54(19)	1297.71	0.557E-22	P(35)	66	1879.647 86(13)*	709.47	0.557E-21	C
32	1876.903 14(24)*	881.21	0.882E-22	R(10)	67	1879.754 93(9)*	201.19	0.340E-20	P(31)
33	1876.973 61(9)*	300.54	0.256E-20	P(38)	68	1879.768 96(23)*	920.85	0.119E-21	R(17)
34	1877.008 88(13)*	790.88	0.449E-21	P(36)	69	1879.874 71(13)*	697.09	0.572E-21	P(29)
35	1877.101 12(19)	1283.47	0.580E-22	P(34)	70	1879.942 24(19)	1195.16	0.708E-22	F

OCS 266 Pa (2.0 Torr) 1 m

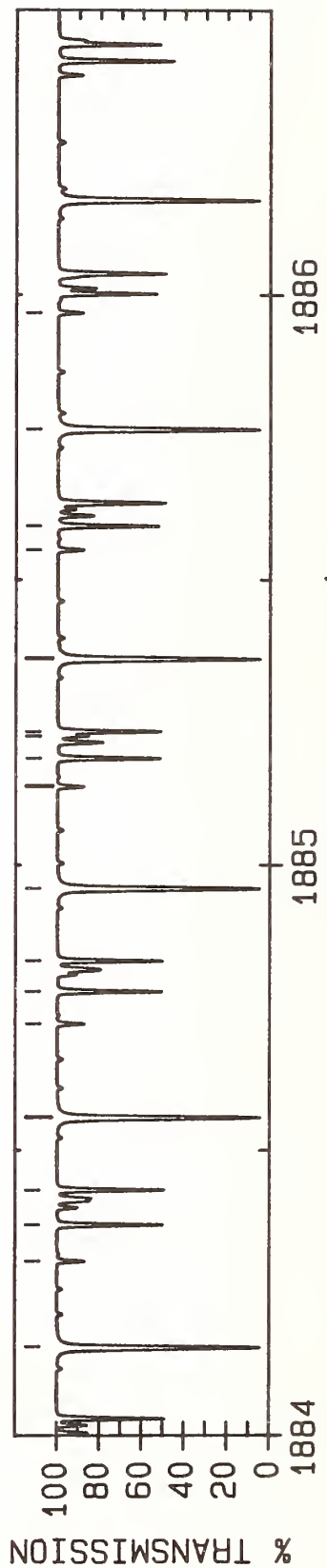
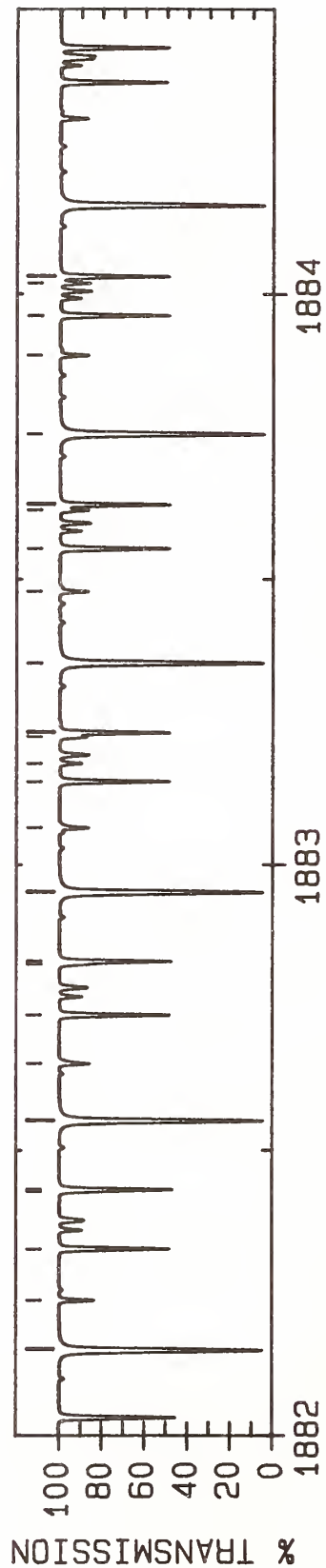
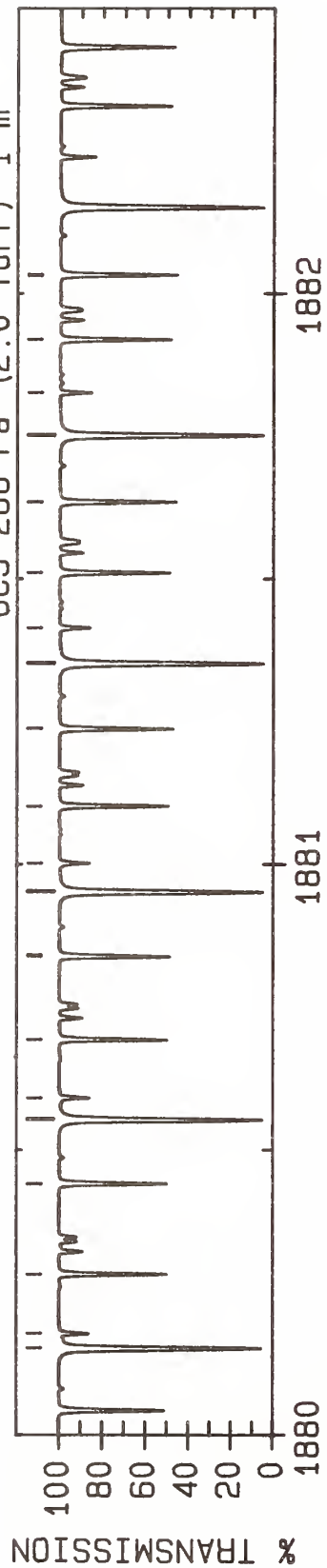

WAVENUMBERS (cm⁻¹)

LINE #	WAVENUMBER(unc) (cm ⁻¹)	LOWER STATE (cm ⁻¹)	INTENSITY (cm/molecule)	ASSIGNMENT ROTATION BAND	LINE #	WAVENUMBER(unc) (cm ⁻¹)	LOWER STATE (cm ⁻¹)	INTENSITY (cm/molecule)	ASSIGNMENT ROTATION BAND	LINE #	WAVENUMBER(unc) (cm ⁻¹)	LOWER STATE (cm ⁻¹)	INTENSITY (cm/molecule)	ASSIGNMENT ROTATION BAND
1	1880.153 55(9)*	188.62	0.350E-20	P(30) A	36	1883.064 92(23)*	990.41	0.123E-21	R(25) D					
2	1880.179 71(23)*	928.13	0.121E-21	R(18) D	37	1883.145 44(13)*	614.25	0.620E-21	P(21) B					
3	1880.283 84(13)*	685.31	0.585E-21	P(28) B	38	1883.177 03(18)	1109.30	0.908E-22	P(17) G					
4	1880.441 51(13)*	685.49	0.584E-21	P(28) C	39	1883.223 48(19)*	14.25	0.106E-21	R(8) P					
5	1880.552 48(9)*	176.45	0.359E-20	P(29) A	40	1883.230 78(13)*	614.35	0.619E-21	P(21) C					
6	1880.590 82(23)*	935.82	0.123E-21	R(19) D	41	1883.352 96(9)*	102.63	0.390E-20	P(22) A					
7	1880.692 89(13)*	673.94	0.596E-21	P(27) B	42	1883.478 55(23)*	1000.93	0.121E-21	R(26) D					
8	1880.838 89(13)*	674.10	0.595E-21	P(27) C	43	1883.553 89(13)*	605.72	0.615E-21	P(20) B					
9	1880.841 16(20)*	1.19	0.376E-22	R(2) P	44	1883.621 21(19)*	17.81	0.116E-21	R(9) P					
10	1880.951 71(9)*	164.69	0.367E-20	P(28) A	45	1883.630 68(13)*	605.81	0.615E-21	P(20) C					
11	1881.002 27(23)*	943.90	0.124E-21	R(20) D	46	1883.754 10(9)*	93.71	0.389E-20	P(21) A					
12	1881.101 86(13)*	662.98	0.605E-21	P(26) B	47	1883.892 57(23)*	1011.84	0.119E-21	R(27) D					
13	1881.236 64(13)*	663.13	0.605E-21	P(26) C	48	1883.962 24(13)*	597.60	0.608E-21	P(19) B					
14	1881.237 74(20)*	2.38	0.499E-22	R(3) P	49	1884.019 13(19)*	21.77	0.125E-21	R(10) P					
15	1881.351 22(9)*	153.34	0.374E-20	P(27) A	50	1884.030 92(13)*	597.68	0.608E-21	P(19) C					
16	1881.414 07(23)*	952.40	0.125E-21	R(21) D	51	1884.155 49(9)*	85.19	0.387E-20	P(20) A					
17	1881.510 75(13)*	652.42	0.613E-21	P(25) B	52	1884.306 98(23)*	1023.17	0.117E-21	R(28) D					
18	1881.634 50(20)*	3.96	0.619E-22	R(4) P	53	1884.370 49(13)*	589.88	0.598E-21	P(18) B					
19	1881.634 75(13)*	652.56	0.612E-21	P(25) C	54	1884.431 52(13)*	589.95	0.598E-21	P(18) C					
20	1881.751 02(9)*	142.38	0.380E-20	P(26) A	55	1884.557 13(9)*	77.08	0.382E-20	P(19) A					
21	1881.826 24(23)*	961.29	0.125E-21	R(22) D	56	1884.721 77(23)*	1034.89	0.114E-21	R(29) D					
22	1881.919 56(13)*	642.27	0.618E-21	P(24) B	57	1884.778 64(13)*	582.57	0.585E-21	P(17) B					
23	1882.031 45(20)*	5.94	0.735E-22	R(5) P	58	1884.832 47(13)*	582.63	0.585E-21	P(17) C					
24	1882.033 22(13)*	642.40	0.618E-21	P(24) C	59	1884.959 01(9)*	69.37	0.376E-20	P(18) A					
25	1882.151 10(9)*	131.84	0.385E-20	P(25) A	60	1885.136 96(23)*	1047.02	0.111E-21	R(30) D					
26	1882.238 76(23)*	970.60	0.125E-21	R(23) D	61	1885.186 69(13)*	575.66	0.569E-21	P(16) B					
27	1882.328 28(13)*	632.52	0.621E-21	P(23) B	62	1885.225 53(20)	1084.04	0.622E-22	P(14) E					
28	1882.428 60(20)*	8.31	0.848E-22	R(6) P	63	1885.226 10(19)	1084.04	0.622E-22	P(14) F					
29	1882.432 05(13)*	632.64	0.621E-21	P(23) C	64	1885.233 76(13)*	575.72	0.569E-21	P(16) C					
30	1882.551 46(9)*	121.70	0.388E-20	P(24) A	65	1885.361 13(9)*	62.07	0.368E-20	P(17) A					
31	1882.651 65(23)*	980.30	0.124E-21	R(24) D	66	1885.552 56(23)*	1059.56	0.108E-21	R(31) D					
32	1882.736 91(13)*	623.18	0.622E-21	P(22) B	67	1885.594 63(13)*	569.16	0.551E-21	P(15) B					
33	1882.825 94(19)*	11.08	0.957E-22	R(7) P	68	1885.763 49(9)*	55.17	0.358E-20	P(16) A					
34	1882.831 24(13)*	623.29	0.621E-21	P(22) C	69	1885.968 56(23)*	1072.49	0.105E-21	R(32) D					
35	1882.952 07(9)*	111.96	0.390E-20	P(23) A										

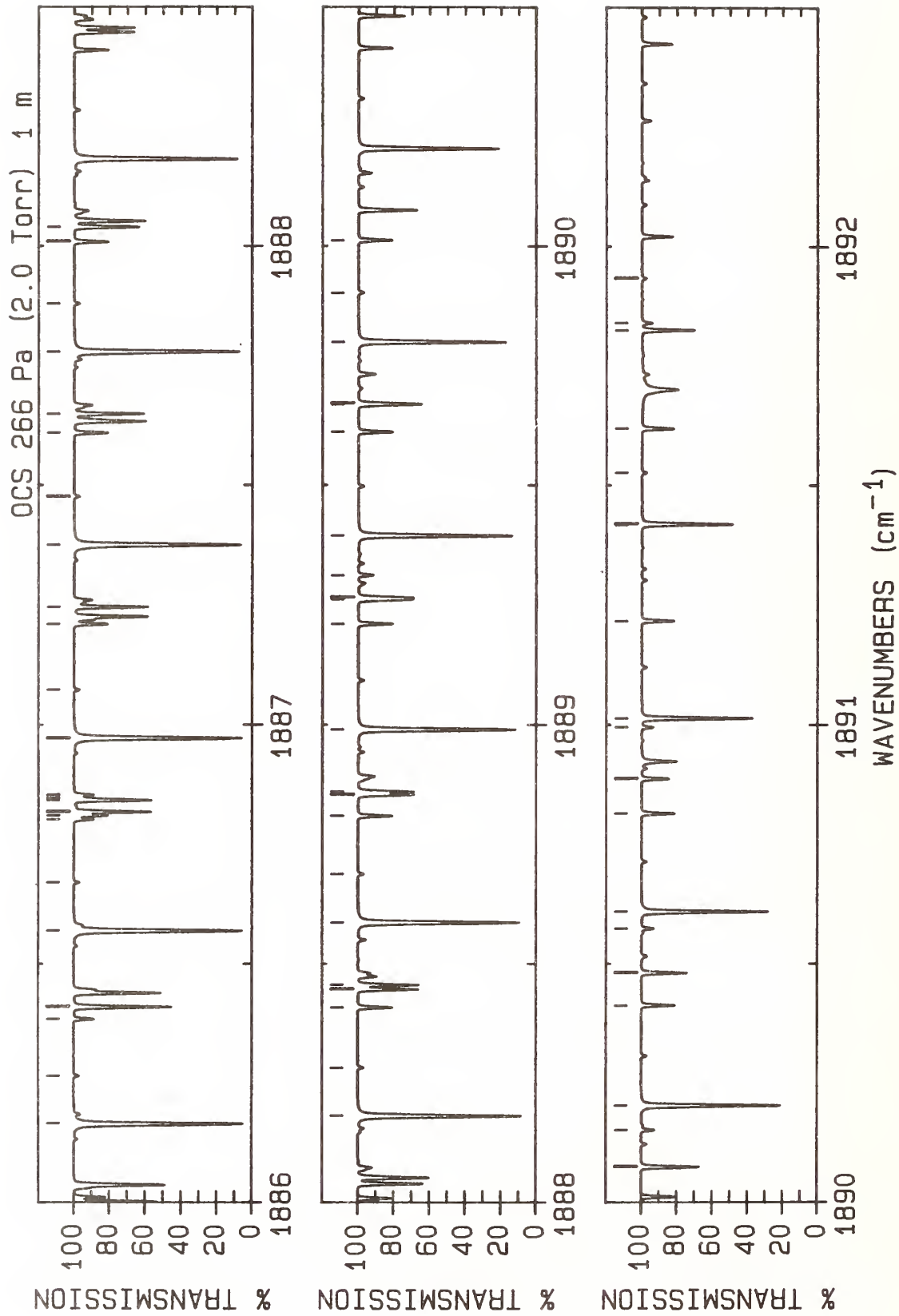

LINE #	WAVENUMBER(unc) (cm ⁻¹)	LOWER STATE (cm ⁻¹)	INTENSITY (cm/molecule)	ASSIGNMENT ROTATION BAND	LINE #	WAVENUMBER(unc) (cm ⁻¹)	LOWER STATE (cm ⁻¹)	INTENSITY (cm/molecule)	ASSIGNMENT ROTATION BAND
1	1886.166 08(9)*	48.68	0.347E-20	P(15) A	36	1888.860 73(13)*	531.81	0.304E-21	P(7) C
2	1886.266 96(8)	580.35	0.271E-22	R(17) R	37	1888.990 38(9)*	14.61	0.218E-20	P(8) A
3	1886.384 99(23)*	1085.84	0.101E-21	R(33) D	38	1889.210 45(18)*	109.23	0.179E-21	R(23) P
4	1886.410 21(13)*	557.38	0.505E-21	P(13) B	39	1889.261 21(13)*	528.95	0.262E-21	P(6) B
5	1886.410 80(19)*	53.83	0.165E-21	R(16) P	40	1889.265 40(13)*	528.96	0.262E-21	P(6) C
6	1886.568 89(9)*	42.60	0.333E-20	P(14) A	41	1889.312 19(23)*	1190.54	0.730E-22	R(40) D
7	1886.669 66(8)	587.48	0.276E-22	R(18) R	42	1889.394 70(9)*	11.36	0.194E-20	P(7) A
8	1886.801 83(23)*	1099.58	0.972E-22	R(34) D	43	1889.611 26(18)*	118.72	0.178E-21	R(24) P
9	1886.810 12(19)*	60.55	0.170E-21	R(17) P	44	1889.668 03(13)*	526.51	0.218E-21	P(5) B
10	1886.817 83(13)*	552.11	0.478E-21	P(12) B	45	1889.670 40(13)*	526.52	0.218E-21	P(5) C
11	1886.842 37(13)*	552.14	0.478E-21	P(12) C	46	1889.799 22(9)*	8.52	0.169E-20	P(6) A
12	1886.846 80(20)	1061.69	0.540E-22	P(8) G	47	1889.902 50(6)	658.87	0.278E-22	R(26) R
13	1886.853 23(20)	1063.68	0.481E-22	P(10) E	48	1890.012 31(18)*	128.62	0.176E-21	R(25) P
14	1886.853 35(20)	1063.68	0.481E-22	P(10) F	49	1890.074 73(13)*	524.48	0.172E-21	P(4) B
15	1886.971 93(9)*	36.92	0.318E-20	P(13) A	50	1890.075 73(13)*	524.49	0.172E-21	P(4) C
16	1887.072 68(8)	595.02	0.280E-22	R(19) R	51	1890.152 71(23)*	1224.09	0.650E-22	R(42) D
17	1887.209 64(19)*	67.68	0.173E-21	R(18) P	52	1890.203 95(9)*	6.09	0.142E-20	P(5) A
18	1887.245 37(13)*	547.26	0.448E-21	P(11) C	53	1890.413 58(18)*	138.90	0.174E-21	R(26) P
19	1887.375 19(9)*	31.64	0.302E-20	P(12) A	54	1890.481 31(13)*	522.86	0.124E-21	P(3) B
20	1887.476 01(7)	602.95	0.283E-22	R(20) R	55	1890.481 38(13)*	522.86	0.124E-21	P(3) C
21	1887.609 38(19)*	75.19	0.176E-21	R(19) P	56	1890.573 70(23)*	1241.47	0.611E-22	R(43) D
22	1887.648 71(13)*	542.79	0.416E-21	P(10) C	57	1890.608 88(9)*	4.06	0.115E-20	P(4) A
23	1887.778 67(9)*	26.78	0.283E-20	P(11) A	58	1890.815 09(18)*	149.59	0.171E-21	R(27) P
24	1887.879 65(7)	611.28	0.285E-22	R(21) R	59	1890.887 37(13)*	521.64	0.699E-22	P(2) C
25	1888.009 32(18)*	83.11	0.177E-21	R(20) P	60	1890.887 76(13)*	521.64	0.699E-22	P(2) B
26	1888.040 04(13)*	538.70	0.381E-21	P(9) B	61	1890.995 20(23)*	1259.25	0.572E-22	R(44) D
27	1888.182 36(9)*	22.31	0.263E-20	P(10) A	62	1891.014 00(9)*	2.43	0.870E-21	P(3) A
28	1888.283 60(7)	620.01	0.286E-22	R(22) R	63	1891.216 84(18)*	160.67	0.168E-21	R(28) P
29	1888.409 48(18)*	91.42	0.178E-21	R(21) P	64	1891.417 21(23)*	1277.44	0.535E-22	R(45) D
30	1888.447 21(13)*	535.04	0.343E-21	P(8) B	65	1891.419 33(9)*	1.22	0.584E-21	P(2) A
31	1888.456 39(13)*	535.06	0.343E-21	P(8) C	66	1891.526 38(6)	704.08	0.257E-22	R(30) R
32	1888.586 27(9)*	18.26	0.242E-20	P(9) A	67	1891.618 83(18)*	172.14	0.164E-21	R(29) P
33	1888.687 86(6)	629.13	0.286E-22	R(23) R	68	1891.824 84(9)*	0.41	0.293E-21	P(1) A
34	1888.809 85(18)*	100.13	0.179E-21	R(22) P	69	1891.839 74(23)*	1296.03	0.499E-22	R(46) D
35	1888.854 27(13)*	531.80	0.304E-21	P(7) B	70	1891.933 13(7)	716.37	0.250E-22	R(31) R

OCS 266 Pa (2.0 Torr) 1 m

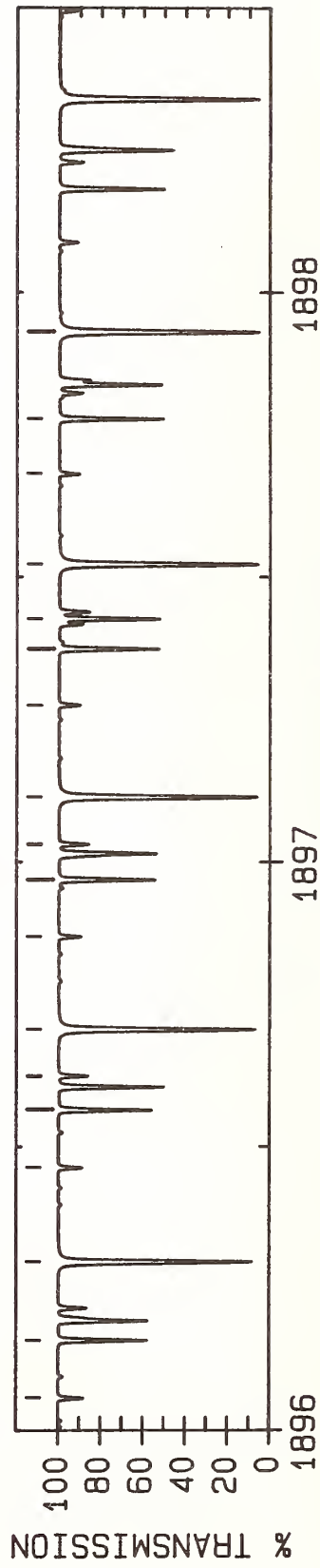
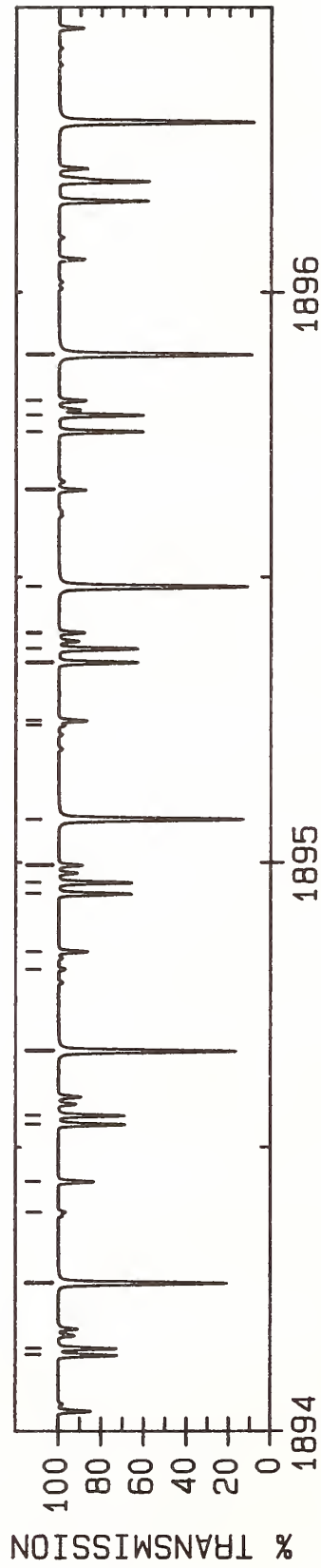
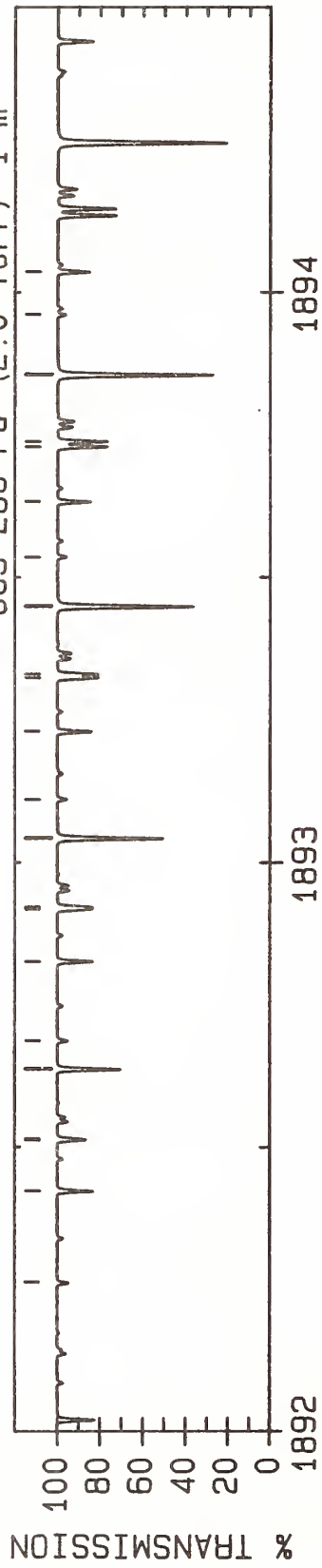

WAVELENGTHS (cm⁻¹)

LINE #	WAVENUMBER(unc) (cm ⁻¹)	LOWER STATE (cm ⁻¹)	INTENSITY (cm/molecule)	ASSIGNMENT ROTATION BAND	LINE #	WAVENUMBER(unc) (cm ⁻¹)	LOWER STATE (cm ⁻¹)	INTENSITY (cm/molecule)	ASSIGNMENT ROTATION BAND	LINE #	WAVENUMBER(unc) (cm ⁻¹)	LOWER STATE (cm ⁻¹)	INTENSITY (cm/molecule)	ASSIGNMENT ROTATION BAND
1	1892.262 81(23)*	1315.02	0.464E-22	R(47) D	36	1894.995 59(20)	1059.61	0.493E-22	R(9) F	36	1894.995 59(20)	1059.61	0.493E-22	R(9) F
2	1892.423 55(18)*	196.27	0.156E-21	R(31) P	37	1895.075 93(9)*	8.52	0.198E-20	R(6) A	37	1895.075 93(9)*	8.52	0.198E-20	R(6) A
3	1892.512 34(13)*	520.83	0.702E-22	R(1) B	38	1895.239 94(24)*	1459.26	0.262E-22	R(54) D	38	1895.239 94(24)*	1459.26	0.262E-22	R(54) D
4	1892.514 54(13)*	520.83	0.702E-22	R(1) C	39	1895.248 42(18)*	293.19	0.119E-21	R(38) P	39	1895.248 42(18)*	293.19	0.119E-21	R(38) P
5	1892.636 46(9)*	0.00	0.294E-21	R(0) A	40	1895.350 39(13)*	535.04	0.389E-21	R(8) B	40	1895.350 39(13)*	535.04	0.389E-21	R(8) B
6	1892.686 41(23)*	1334.42	0.431E-22	R(48) D	41	1895.374 41(13)*	535.06	0.389E-21	R(8) C	41	1895.374 41(13)*	535.06	0.389E-21	R(8) C
7	1892.826 29(18)*	208.93	0.151E-21	R(32) P	42	1895.402 48(20)	1063.68	0.536E-22	R(10) E	42	1895.402 48(20)	1063.68	0.536E-22	R(10) E
8	1892.918 17(13)*	521.64	0.124E-21	R(2) B	43	1895.402 86(20)	1063.68	0.536E-22	R(10) F	43	1895.402 86(20)	1063.68	0.536E-22	R(10) F
9	1892.922 13(13)*	521.64	0.124E-21	R(2) C	44	1895.483 18(9)*	11.36	0.223E-20	R(7) A	44	1895.483 18(9)*	11.36	0.223E-20	R(7) A
10	1893.042 56(9)*	0.41	0.587E-21	R(1) A	45	1895.653 11(18)*	308.62	0.113E-21	R(39) P	45	1895.653 11(18)*	308.62	0.113E-21	R(39) P
11	1893.110 57(23)*	1354.22	0.399E-22	R(49) D	46	1895.755 30(13)*	538.70	0.426E-21	R(9) B	46	1895.755 30(13)*	538.70	0.426E-21	R(9) B
12	1893.229 30(18)*	221.99	0.146E-21	R(33) P	47	1895.784 23(13)*	538.72	0.426E-21	R(9) C	47	1895.784 23(13)*	538.72	0.426E-21	R(9) C
13	1893.323 86(13)*	522.86	0.174E-21	R(3) B	48	1895.809 62(20)	1068.16	0.575E-22	R(11) E	48	1895.809 62(20)	1068.16	0.575E-22	R(11) E
14	1893.330 05(13)*	522.86	0.174E-21	R(3) C	49	1895.810 15(20)	1068.16	0.575E-22	R(11) F	49	1895.810 15(20)	1068.16	0.575E-22	R(11) F
15	1893.448 86(9)*	1.22	0.877E-21	R(2) A	50	1895.890 62(9)*	14.61	0.247E-20	R(8) A	50	1895.890 62(9)*	14.61	0.247E-20	R(8) A
16	1893.535 28(23)*	1374.42	0.368E-22	R(50) D	51	1896.058 09(18)*	324.44	0.107E-21	R(40) P	51	1896.058 09(18)*	324.44	0.107E-21	R(40) P
17	1893.632 57(18)*	235.44	0.141E-21	R(34) P	52	1896.160 07(13)*	542.76	0.460E-21	R(10) B	52	1896.160 07(13)*	542.76	0.460E-21	R(10) B
18	1893.729 43(13)*	524.48	0.221E-21	R(4) B	53	1896.298 25(9)*	18.26	0.269E-20	R(9) A	53	1896.298 25(9)*	18.26	0.269E-20	R(9) A
19	1893.738 29(13)*	524.49	0.221E-21	R(4) C	54	1896.463 39(18)*	340.66	0.101E-21	R(41) P	54	1896.463 39(18)*	340.66	0.101E-21	R(41) P
20	1893.855 34(9)*	2.43	0.116E-20	R(3) A	55	1896.564 71(13)*	547.23	0.492E-21	R(11) B	55	1896.564 71(13)*	547.23	0.492E-21	R(11) B
21	1893.960 57(23)*	1395.03	0.339E-22	R(51) D	56	1896.623 79(19)	1078.34	0.643E-22	R(13) E	56	1896.623 79(19)	1078.34	0.643E-22	R(13) E
22	1894.036 11(18)*	249.29	0.136E-21	R(35) P	57	1896.624 75(19)	1078.34	0.643E-22	R(13) F	57	1896.624 75(19)	1078.34	0.643E-22	R(13) F
23	1894.134 87(13)*	526.51	0.266E-21	R(5) B	58	1896.706 07(9)*	22.31	0.291E-20	R(10) A	58	1896.706 07(9)*	22.31	0.291E-20	R(10) A
24	1894.146 84(13)*	526.52	0.266E-21	R(5) C	59	1896.869 00(18)*	357.27	0.956E-22	R(42) P	59	1896.869 00(18)*	357.27	0.956E-22	R(42) P
25	1894.262 01(9)*	4.06	0.144E-20	R(4) A	60	1896.969 21(13)*	552.11	0.521E-21	R(12) B	60	1896.969 21(13)*	552.11	0.521E-21	R(12) B
26	1894.386 43(23)*	1416.04	0.312E-22	R(52) D	61	1897.030 82(19)	1084.04	0.672E-22	R(14) E	61	1897.030 82(19)	1084.04	0.672E-22	R(14) E
27	1894.439 93(18)*	263.53	0.130E-21	R(36) P	62	1897.032 07(19)	1084.04	0.672E-22	R(14) F	62	1897.032 07(19)	1084.04	0.672E-22	R(14) F
28	1894.540 17(13)*	528.95	0.309E-21	R(6) B	63	1897.114 09(9)*	26.78	0.310E-20	R(11) A	63	1897.114 09(9)*	26.78	0.310E-20	R(11) A
29	1894.555 72(13)*	528.96	0.309E-21	R(6) C	64	1897.274 92(18)*	374.27	0.900E-22	R(43) P	64	1897.274 92(18)*	374.27	0.900E-22	R(43) P
30	1894.668 88(9)*	6.09	0.171E-20	R(5) A	65	1897.373 58(13)*	557.38	0.547E-21	R(13) B	65	1897.373 58(13)*	557.38	0.547E-21	R(13) B
31	1894.812 89(24)*	1437.45	0.286E-22	R(53) D	66	1897.426 65(13)*	557.42	0.547E-21	R(13) C	66	1897.426 65(13)*	557.42	0.547E-21	R(13) C
32	1894.844 03(18)*	278.16	0.124E-21	R(37) P	67	1897.522 30(9)*	31.64	0.328E-20	R(12) A	67	1897.522 30(9)*	31.64	0.328E-20	R(12) A
33	1894.945 35(13)*	531.80	0.350E-21	R(7) B	68	1897.681 18(18)*	391.68	0.846E-22	R(44) P	68	1897.681 18(18)*	391.68	0.846E-22	R(44) P
34	1894.964 90(13)*	531.81	0.350E-21	R(7) C	69	1897.777 81(13)*	563.07	0.571E-21	R(14) B	69	1897.777 81(13)*	563.07	0.571E-21	R(14) B
35	1894.995 32(20)	1059.61	0.493E-22	R(9) E	70	1897.930 70(9)*	36.92	0.345E-20	R(13) A	70	1897.930 70(9)*	36.92	0.345E-20	R(13) A

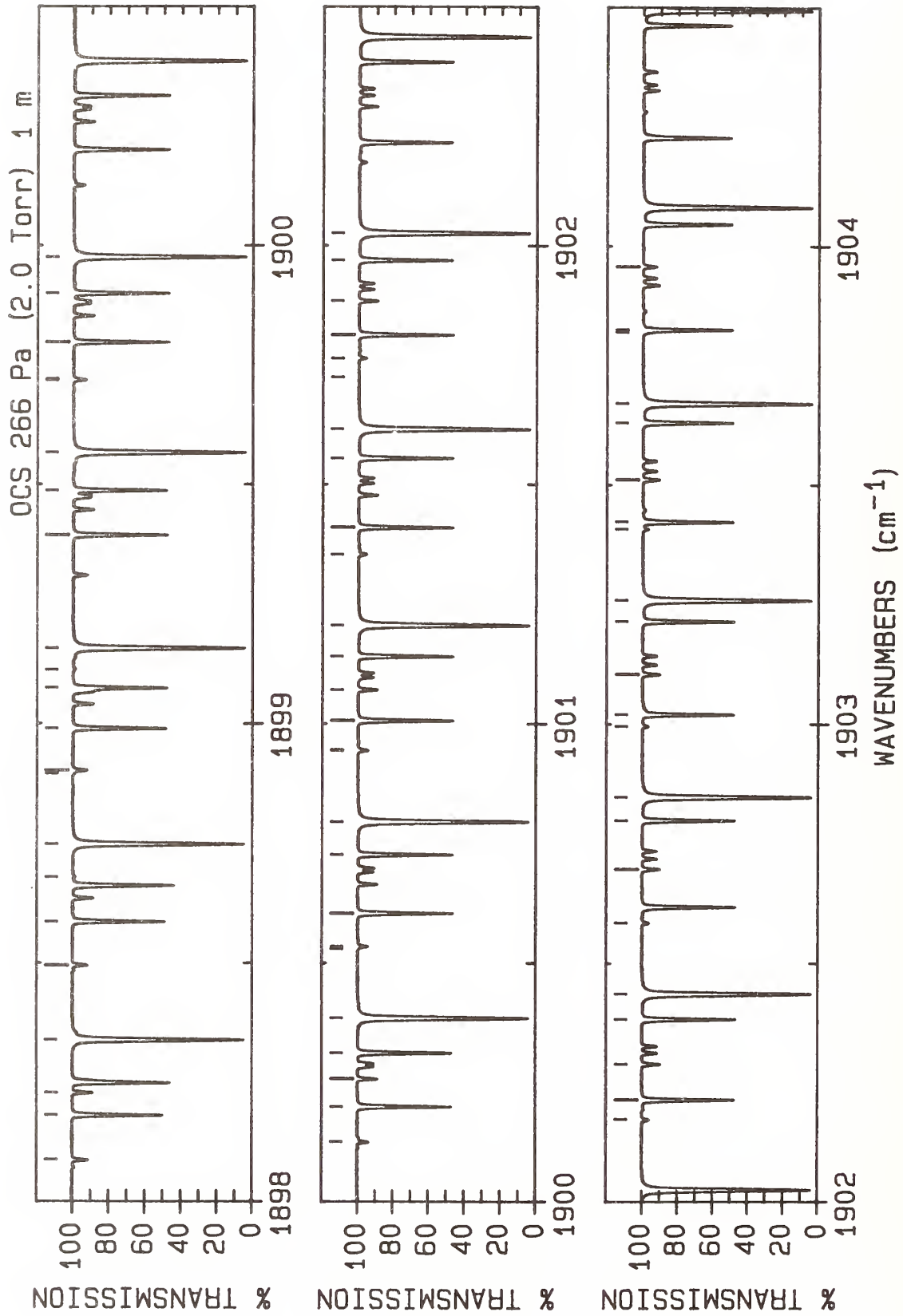

LINE #	WAVENUMBER(cm^{-1})	LOWER STATE (cm^{-1})	INTENSITY ($\text{cm}^2/\text{molecule}$)	ASSIGNMENT ROTATION BAND	LINE #	WAVENUMBER(cm^{-1})	LOWER STATE (cm^{-1})	INTENSITY ($\text{cm}^2/\text{molecule}$)	ASSIGNMENT ROTATION BAND
1	1898.087 77(18)*	409.47	0.793E-22	R(45) P	36	1901.070 72(17)	1189.87	0.983E-22	R(26) G
2	1898.181 90(13)*	569.16	0.592E-21	R(15) B	37	1901.140 33(13)*	623.29	0.656E-21	R(22) C
3	1898.228 71(17)	1124.36	0.100E-21	R(19) G	38	1901.205 22(9)*	93.71	0.412E-20	R(21) A
4	1898.339 31(9)*	42.60	0.359E-20	R(14) A	39	1901.353 43(18)*	566.04	0.432E-22	R(53) P
5	1898.494 70(18)*	427.66	0.741E-22	R(46) P	40	1901.409 74(13)*	632.52	0.655E-21	R(23) B
6	1898.585 86(13)*	575.66	0.610E-21	R(16) B	41	1901.554 51(13)*	632.64	0.654E-21	R(23) C
7	1898.679 13(24)*	1648.29	0.118E-22	R(62) D	42	1901.615 48(9)*	102.63	0.412E-20	R(22) A
8	1898.748 11(9)*	48.68	0.372E-20	R(15) A	43	1901.724 19(25)*	1834.81	0.519E-23	R(69) D
9	1898.895 65(10)	985.93	0.103E-22	R(48) R	44	1901.763 37(18)*	587.39	0.396E-22	R(54) P
10	1898.901 99(18)*	446.25	0.691E-22	R(47) P	45	1901.812 60(13)*	642.27	0.651E-21	R(24) B
11	1898.989 68(13)*	582.57	0.624E-21	R(17) B	46	1901.883 52(17)	1212.24	0.947E-22	R(28) G
12	1899.074 07(13)*	582.63	0.624E-21	R(17) C	47	1901.969 00(13)*	642.40	0.650E-21	R(24) C
13	1899.112 02(24)*	1673.73	0.106E-22	R(63) D	48	1902.025 95(9)*	111.96	0.411E-20	R(23) A
14	1899.157 11(9)*	55.17	0.383E-20	R(16) A	49	1902.173 71(18)*	609.13	0.362E-22	R(55) P
15	1899.393 37(13)*	589.88	0.636E-21	R(18) B	50	1902.215 33(13)*	652.42	0.644E-21	R(25) B
16	1899.486 70(13)*	589.95	0.636E-21	R(18) C	51	1902.290 13(17)	1224.04	0.925E-22	R(29) G
17	1899.566 32(9)*	62.07	0.393E-20	R(17) A	52	1902.383 80(13)*	652.56	0.644E-21	R(25) C
18	1899.717 63(18)*	484.60	0.596E-22	R(49) P	53	1902.436 65(9)*	121.70	0.408E-20	R(24) A
19	1899.720 75(10)	1025.16	0.889E-23	R(50) R	54	1902.584 48(18)*	631.27	0.331E-22	R(56) P
20	1899.796 92(13)*	597.60	0.646E-21	R(19) B	55	1902.696 89(17)	1236.25	0.901E-22	R(30) G
21	1899.899 64(13)*	597.68	0.645E-21	R(19) C	56	1902.798 91(13)*	663.13	0.635E-21	R(26) C
22	1899.975 73(9)*	69.37	0.400E-20	R(18) A	57	1902.847 57(9)*	131.84	0.404E-20	R(25) A
23	1900.126 00(18)*	504.37	0.552E-22	R(50) P	58	1902.995 68(18)*	653.80	0.301E-22	R(57) P
24	1900.200 33(13)*	605.72	0.652E-21	R(20) B	59	1903.020 38(13)*	673.94	0.625E-21	R(27) B
25	1900.258 37(17)	1169.12	0.101E-21	R(24) G	60	1903.103 83(17)	1248.86	0.874E-22	R(31) G
26	1900.312 89(13)*	605.81	0.652E-21	R(20) C	61	1903.214 33(13)*	674.10	0.625E-21	R(27) C
27	1900.385 35(9)*	77.08	0.406E-20	R(19) A	62	1903.258 72(9)*	142.38	0.399E-20	R(26) A
28	1900.529 67(13)	214.17	0.789E-23	R(32) X	63	1903.407 31(18)*	676.72	0.274E-22	R(58) P
29	1900.534 75(18)*	524.53	0.510E-22	R(51) P	64	1903.422 70(13)*	685.31	0.613E-21	R(28) B
30	1900.603 60(13)*	614.25	0.656E-21	R(21) B	65	1903.510 97(17)	1261.88	0.846E-22	R(32) G
31	1900.726 46(13)*	614.35	0.655E-21	R(21) C	66	1903.630 06(13)*	685.49	0.613E-21	R(28) C
32	1900.795 18(9)*	85.19	0.409E-20	R(20) A	67	1903.670 10(9)*	153.34	0.392E-20	R(27) A
33	1900.943 89(18)*	545.09	0.470E-22	R(52) P	68	1903.819 38(18)*	700.04	0.248E-22	R(59) P
34	1900.945 88(13)	227.55	0.858E-23	R(33) X	69	1903.824 89(13)*	697.09	0.599E-21	R(29) B
35	1901.006 74(13)*	623.18	0.656E-21	R(22) B	70	1903.957 24(19)	1243.18	0.673E-22	R(31) F

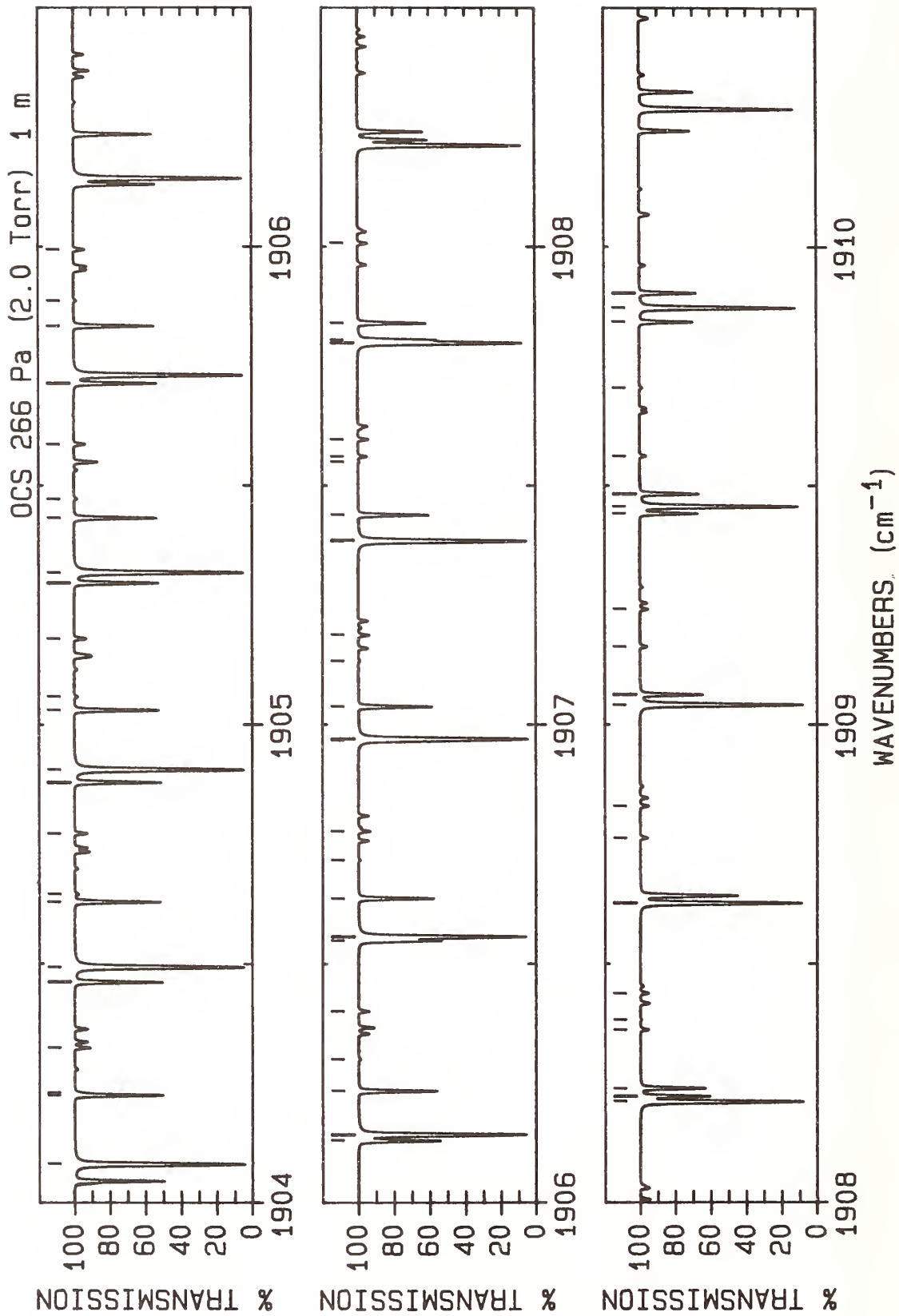

LINE #	WAVENUMBER(unc) (cm ⁻¹)	LOWER STATE (cm ⁻¹)	INTENSITY (cm/molecule)	ASSIGNMENT ROTATION BAND	LINE #	WAVENUMBER(unc) (cm ⁻¹)	LOWER STATE (cm ⁻¹)	INTENSITY (cm/molecule)	ASSIGNMENT ROTATION BAND
1	1904.081 73(9)*	164.69	0.385E-20	R(28) A	36	1907.037 68(13)*	805.90	0.448E-21	R(37) B
2	1904.226 94(13)*	709.27	0.583E-21	R(30) B	37	1907.132 84(19)*	900.76	0.105E-22	R(67) P
3	1904.231 90(18)*	723.75	0.225E-22	R(60) P	38	1907.186 84(16)	1397.33	0.556E-22	R(41) G
4	1904.325 89(17)	1289.13	0.786E-22	R(34) G	39	1907.383 79(9)*	270.13	0.294E-20	R(36) A
5	1904.462 45(13)*	709.47	0.583E-21	R(30) C	40	1907.385 56(13)*	806.20	0.447E-21	R(37) C
6	1904.493 59(9)*	176.45	0.376E-20	R(29) A	41	1907.438 70(13)*	821.33	0.426E-21	R(38) B
7	1904.628 86(13)*	721.86	0.567E-21	R(31) B	42	1907.549 24(19)*	927.63	0.929E-23	R(68) P
8	1904.644 88(18)*	747.86	0.203E-22	R(61) P	43	1907.560 86(19)	1374.99	0.455E-22	R(40) E
9	1904.772 06(19)	1269.63	0.630E-22	R(33) F	44	1907.596 91(16)	1414.41	0.524E-22	R(42) G
10	1904.879 11(13)*	722.07	0.566E-21	R(31) C	45	1907.797 77(9)*	285.13	0.280E-20	R(37) A
11	1904.905 70(9)*	188.62	0.366E-20	R(30) A	46	1907.804 39(13)*	821.64	0.426E-21	R(38) C
12	1905.030 65(13)*	734.85	0.549E-21	R(32) B	47	1907.839 61(13)*	837.16	0.405E-21	R(39) B
13	1905.058 33(18)*	772.36	0.183E-22	R(62) P	48	1908.007 37(16)	1431.90	0.492E-22	R(43) G
14	1905.179 48(19)	1283.47	0.606E-22	R(34) F	49	1908.212 03(9)*	300.54	0.267E-20	R(38) A
15	1905.296 07(13)*	735.07	0.548E-21	R(32) C	50	1908.223 53(13)*	837.49	0.405E-21	R(39) C
16	1905.318 06(9)*	201.19	0.355E-20	R(31) A	51	1908.240 40(13)*	853.39	0.384E-21	R(40) B
17	1905.432 31(13)*	748.25	0.530E-21	R(33) B	52	1908.362 78(20)	1408.75	0.405E-22	R(42) E
18	1905.472 25(18)*	797.25	0.164E-22	R(63) P	53	1908.383 61(20)*	982.53	0.728E-23	R(70) P
19	1905.586 90(19)	1297.71	0.582E-22	R(35) F	54	1908.439 11(20)	1408.78	0.406E-22	R(42) F
20	1905.713 35(13)*	748.49	0.529E-21	R(33) C	55	1908.626 59(9)*	316.35	0.253E-20	R(39) A
21	1905.833 84(13)*	762.05	0.510E-21	R(34) B	56	1908.763 06(20)	1426.24	0.380E-22	R(43) E
22	1905.886 66(18)*	822.54	0.147E-22	R(64) P	57	1908.829 56(16)	1468.09	0.431E-22	R(45) G
23	1905.994 33(19)	1312.36	0.557E-22	R(36) F	58	1909.041 45(9)*	332.57	0.240E-20	R(40) A
24	1906.130 94(13)*	762.31	0.510E-21	R(34) C	59	1909.041 62(13)*	887.08	0.342E-21	R(42) B
25	1906.143 55(9)*	227.55	0.332E-20	R(33) A	60	1909.062 74(13)*	870.40	0.362E-21	R(41) C
26	1906.235 25(13)*	776.26	0.490E-21	R(35) B	61	1909.162 87(20)	1444.14	0.357E-22	R(44) E
27	1906.301 55(18)*	848.22	0.132E-22	R(65) P	62	1909.241 33(16)	1486.80	0.402E-22	R(46) G
28	1906.401 77(19)	1327.41	0.532E-22	R(37) F	63	1909.442 06(13)*	904.54	0.321E-21	R(43) B
29	1906.548 83(13)*	776.53	0.489E-21	R(35) C	64	1909.456 61(9)*	349.19	0.227E-20	R(41) A
30	1906.556 69(9)*	241.34	0.320E-20	R(34) A	65	1909.482 82(13)*	887.47	0.341E-21	R(42) C
31	1906.636 52(13)*	790.88	0.469E-21	R(36) B	66	1909.562 18(20)	1462.44	0.334E-22	R(45) E
32	1906.716 94(19)*	874.29	0.117E-22	R(66) P	67	1909.704 37(11)	602.10	0.154E-22	R(54) X
33	1906.777 15(16)	1380.65	0.589E-22	R(40) G	68	1909.842 39(13)*	922.39	0.301E-21	R(44) B
34	1906.967 04(13)*	791.16	0.468E-21	R(36) C	69	1909.872 10(9)*	366.22	0.214E-20	R(42) A
35	1906.970 10(9)*	255.53	0.307E-20	R(35) A	70	1909.903 21(13)*	904.94	0.321E-21	R(43) C

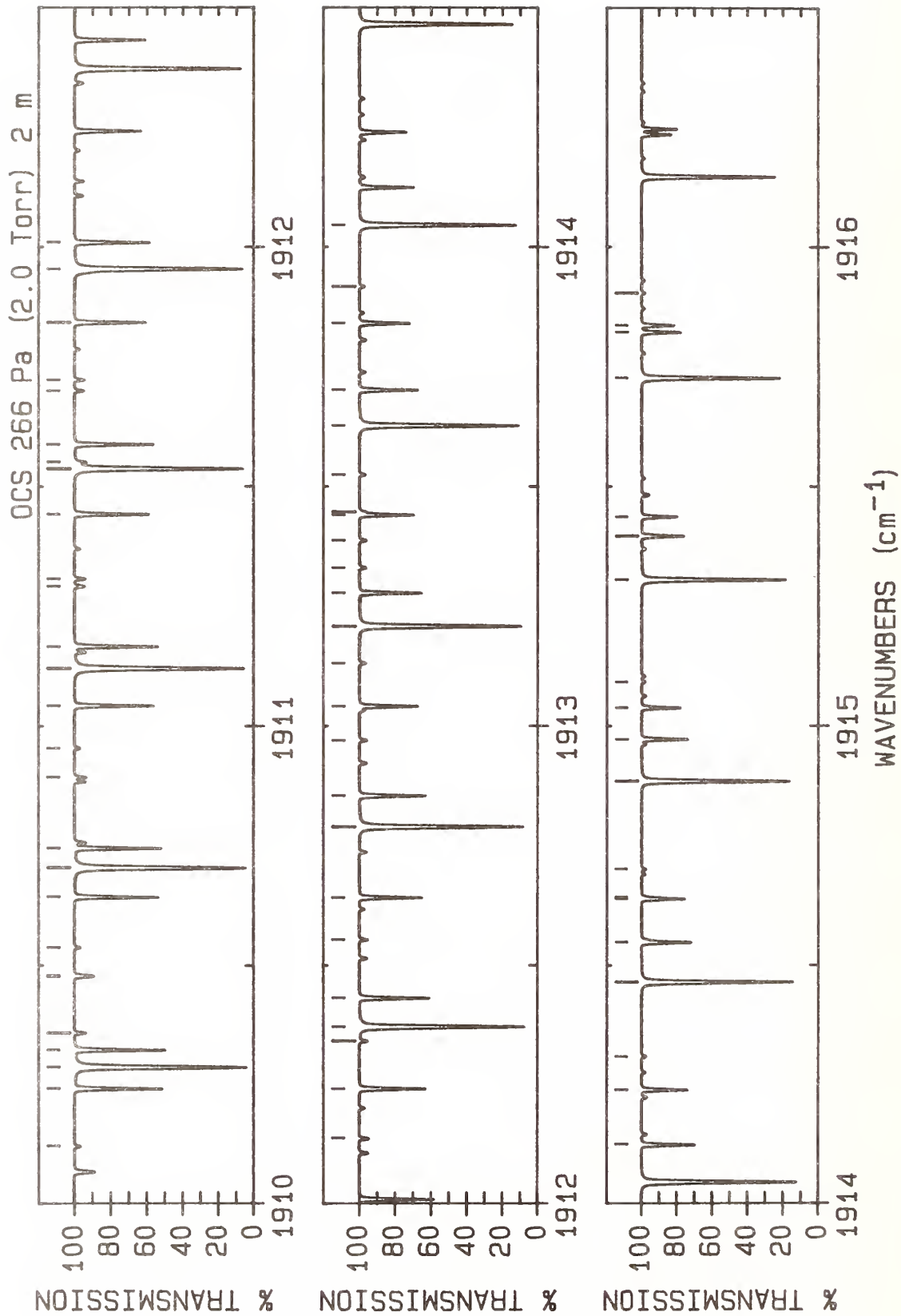

LINE #	WAVENUMBER(unc) (cm ⁻¹)	LOWER STATE (cm ⁻¹)	INTENSITY (cm/molecule)	ASSIGNMENT ROTATION BAND	LINE #	WAVENUMBER(unc) (cm ⁻¹)	LOWER STATE (cm ⁻¹)	INTENSITY (cm/molecule)	ASSIGNMENT ROTATION BAND
1	1910.121 06(10)	624.39	0.151E-22	R(55) X	36	1912.854 73(13)*	1038.59	0.194E-21	R(50) C
2	1910.242 62(13)*	940.66	0.282E-21	R(45) B	37	1912.970 30(17)	1673.42	0.191E-22	R(55) G
3	1910.287 90(9)*	383.65	0.201E-20	R(43) A	38	1913.041 43(13)*	1079.84	0.165E-21	R(52) B
4	1910.323 91(13)*	922.82	0.301E-21	R(44) C	39	1913.131 08(21)	1645.40	0.164E-22	R(54) E
5	1910.359 26(20)	1500.26	0.289E-22	R(47) E	40	1913.208 18(9)*	517.00	0.121E-20	R(50) A
6	1910.476 77(20)	1500.30	0.291E-22	R(47) F	41	1913.277 64(13)*	1059.31	0.179E-21	R(51) C
7	1910.479 51(17)	1545.35	0.321E-22	R(49) G	42	1913.330 36(21)	1645.47	0.165E-22	R(54) F
8	1910.537 59(10)	647.08	0.148E-22	R(56) X	43	1913.387 47(17)	1696.18	0.174E-22	R(56) G
9	1910.642 73(13)*	959.33	0.263E-21	R(46) B	44	1913.440 91(13)*	1101.34	0.151E-21	R(53) B
10	1910.704 04(9)*	401.49	0.188E-20	R(44) A	45	1913.447 39(9)	817.21	0.114E-22	R(63) X
11	1910.744 93(13)*	941.10	0.281E-21	R(45) C	46	1913.524 59(21)	1667.76	0.149E-22	R(55) E
12	1910.893 25(17)	1565.68	0.296E-22	R(50) G	47	1913.626 84(9)*	537.67	0.112E-20	R(51) A
13	1910.953 95(10)	670.17	0.144E-22	R(57) X	48	1913.700 86(13)*	1080.42	0.165E-21	R(52) C
14	1911.042 75(13)*	978.40	0.245E-21	R(47) B	49	1913.840 31(13)*	1123.25	0.139E-21	R(54) B
15	1911.120 51(9)*	419.73	0.176E-20	R(45) A	50	1913.917 43(21)	1690.52	0.136E-22	R(56) E
16	1911.166 26(13)*	959.78	0.263E-21	R(46) C	51	1914.045 88(9)*	558.74	0.103E-20	R(52) A
17	1911.291 96(20)	1539.75	0.250E-22	R(49) F	52	1914.124 41(13)*	1101.95	0.151E-21	R(53) C
18	1911.307 53(17)	1586.42	0.273E-22	R(51) G	53	1914.239 65(13)*	1145.56	0.127E-21	R(55) B
19	1911.442 67(13)*	997.88	0.227E-21	R(48) B	54	1914.309 61(21)	1713.69	0.124E-22	R(57) E
20	1911.537 33(9)*	438.37	0.164E-20	R(46) A	55	1914.465 33(9)*	580.22	0.941E-21	R(53) A
21	1911.550 76(21)	1560.03	0.230E-22	R(50) E	56	1914.548 27(13)*	1123.88	0.138E-21	R(54) C
22	1911.587 91(13)*	978.88	0.244E-21	R(47) C	57	1914.638 92(13)*	1168.28	0.115E-21	R(56) B
23	1911.699 59(21)	1560.08	0.231E-22	R(50) F	58	1914.642 70(18)	1766.91	0.129E-22	R(59) G
24	1911.722 37(17)	1607.56	0.250E-22	R(52) G	59	1914.701 12(21)	1737.26	0.112E-22	R(58) E
25	1911.842 49(13)*	1017.76	0.210E-21	R(49) B	60	1914.885 18(9)*	602.10	0.861E-21	R(54) A
26	1911.954 49(9)*	457.42	0.153E-20	R(47) A	61	1914.972 44(13)*	1146.22	0.126E-21	R(55) C
27	1912.009 87(13)*	998.38	0.227E-21	R(48) C	62	1915.038 13(13)*	1191.40	0.105E-21	R(57) B
28	1912.137 76(17)	1629.11	0.230E-22	R(53) G	63	1915.091 94(21)	1761.24	0.101E-22	R(59) E
29	1912.242 22(13)*	1038.05	0.195E-21	R(50) B	64	1915.305 45(9)*	624.39	0.785E-21	R(55) A
30	1912.342 16(21)	1601.90	0.195E-22	R(52) E	65	1915.396 94(13)*	1168.96	0.115E-21	R(56) C
31	1912.372 02(9)*	476.88	0.142E-20	R(48) A	66	1915.437 29(13)*	1214.93	0.952E-22	R(58) B
32	1912.432 14(13)*	1018.28	0.210E-21	R(49) C	67	1915.726 14(9)*	647.08	0.715E-21	R(56) A
33	1912.553 74(17)	1651.06	0.210E-22	R(54) G	68	1915.821 76(13)*	1192.10	0.105E-21	R(57) C
34	1912.641 87(13)*	1058.74	0.179E-21	R(51) B	69	1915.836 40(13)*	1238.86	0.861E-22	R(59) B
35	1912.789 91(9)*	496.74	0.131E-20	R(49) A	70	1915.903 67(18)	1841.28	0.943E-23	R(62) G

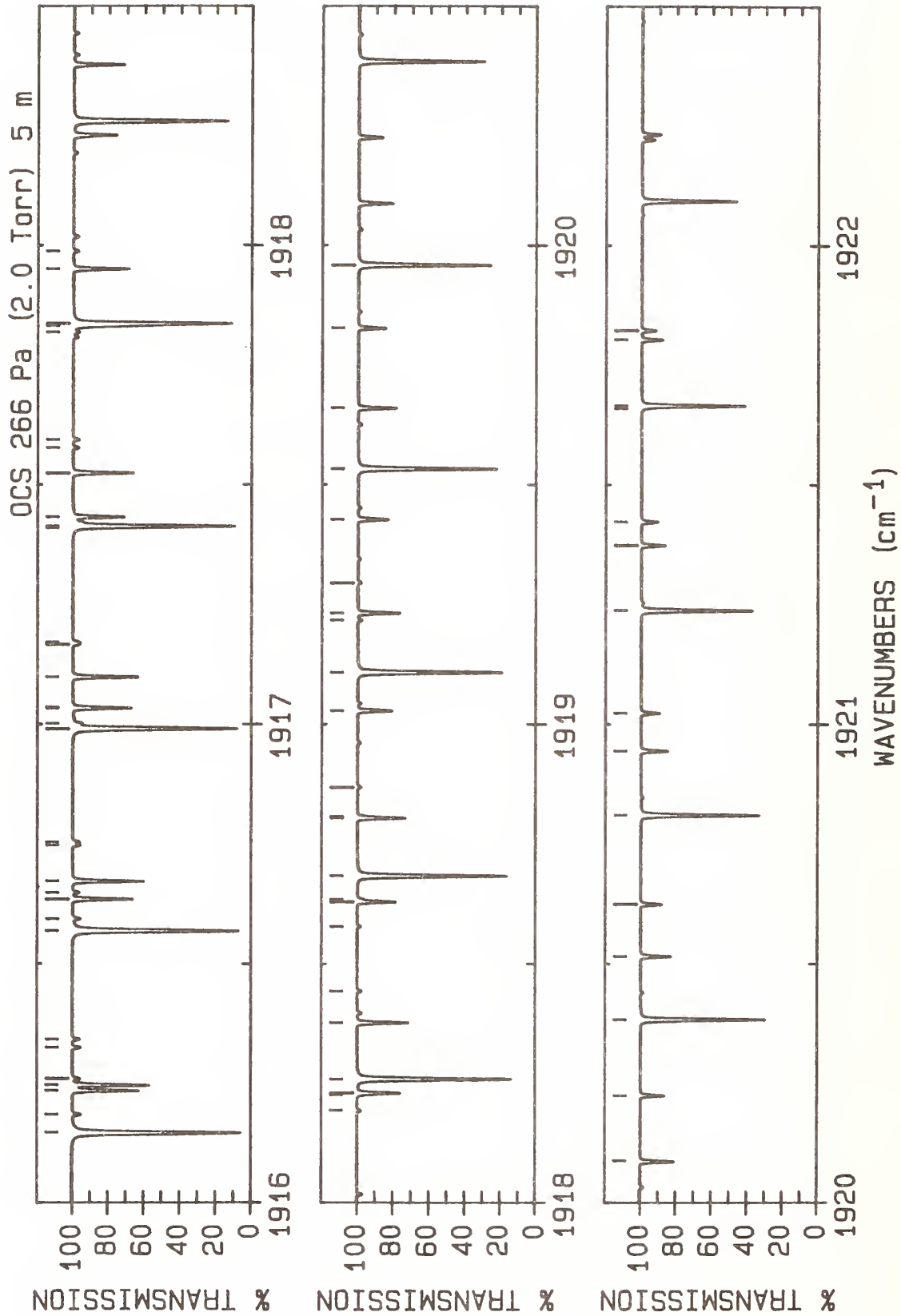

LINE #	WAVENUMBER(unc) (cm ⁻¹)	LOWER STATE (cm ⁻¹)	INTENSITY (cm/molecule)	ASSIGNMENT ROTATION BAND	LINE #	WAVENUMBER(unc) (cm ⁻¹)	LOWER STATE (cm ⁻¹)	INTENSITY (cm/molecule)	ASSIGNMENT ROTATION BAND
1	1916.147 27(9)*	670.17	0.650E-21	R(57) A	36	1918.259 69(9)*	791.70	0.388E-21	R(62) A
2	1916.185 56(21)	1810.52	0.832E-23	R(61) F	37	1918.377 38(13)*	1339.47	0.564E-22	R(63) C
3	1916.235 47(13)*	1263.19	0.778E-22	R(60) B	38	1918.443 32(21)	2000.97	0.471E-23	R(68) G
4	1916.246 89(13)*	1215.65	0.950E-22	R(58) C	39	1918.577 77(21)	1995.24	0.373E-23	R(68) E
5	1916.260 23(21)	1835.60	0.741E-23	R(62) E	40	1918.629 37(13)*	1417.69	0.402E-22	R(66) B
6	1916.325 29(19)	1866.88	0.845E-23	R(63) G	41	1918.634 84(22)	1967.78	0.425E-23	R(67) F
7	1916.342 43(8)	1007.13	0.749E-23	R(70) X	42	1918.683 59(9)*	817.21	0.347E-21	R(63) A
8	1916.568 83(9)*	693.67	0.589E-21	R(58) A	43	1918.804 44(13)*	1365.45	0.505E-22	R(64) C
9	1916.593 62(21)	1835.71	0.748E-23	R(62) F	44	1918.807 56(9)	1185.63	0.459E-23	R(76) X
10	1916.634 50(13)*	1287.93	0.701E-22	R(61) B	45	1918.868 89(21)	2029.00	0.416E-23	R(69) G
11	1916.648 26(21)	1861.19	0.665E-23	R(63) E	46	1919.028 34(13)*	1444.85	0.357E-22	R(67) B
12	1916.672 35(13)*	1239.61	0.860E-22	R(59) C	47	1919.107 99(9)*	843.13	0.311E-21	R(64) A
13	1916.747 58(19)	1892.89	0.755E-23	R(64) G	48	1919.216 67(10)	1216.79	0.419E-23	R(77) X
14	1916.754 45(8)	1035.87	0.696E-23	R(71) X	49	1919.231 82(13)*	1391.83	0.451E-22	R(65) C
15	1916.990 85(9)*	717.57	0.532E-21	R(59) A	50	1919.295 12(22)	2057.44	0.367E-23	R(70) G
16	1917.001 74(21)	1861.32	0.671E-23	R(63) F	51	1919.427 33(13)*	1472.41	0.317E-22	R(68) B
17	1917.033 50(13)*	1313.07	0.630E-22	R(62) B	52	1919.532 88(9)*	869.46	0.277E-21	R(65) A
18	1917.035 58(21)	1887.19	0.595E-23	R(64) E	53	1919.659 53(13)*	1418.62	0.402E-22	R(66) C
19	1917.098 12(13)*	1263.97	0.777E-22	R(60) C	54	1919.826 35(13)*	1500.39	0.281E-22	R(69) B
20	1917.166 02(9)	1065.02	0.644E-23	R(72) X	55	1919.958 28(9)*	896.18	0.246E-21	R(66) A
21	1917.170 52(19)	1919.30	0.673E-23	R(65) G	56	1920.087 55(13)*	1445.81	0.357E-22	R(67) C
22	1917.409 92(21)	1887.33	0.601E-23	R(64) F	57	1920.225 40(14)*	1528.76	0.248E-22	R(70) B
23	1917.413 33(9)*	741.87	0.480E-21	R(60) A	58	1920.384 20(9)*	923.31	0.219E-21	R(67) A
24	1917.432 48(13)*	1338.62	0.565E-22	R(63) B	59	1920.515 90(13)*	1473.41	0.317E-22	R(68) C
25	1917.524 22(13)*	1288.73	0.700E-22	R(61) C	60	1920.624 51(14)*	1557.54	0.218E-22	R(71) B
26	1917.577 14(9)	1094.57	0.595E-23	R(73) X	61	1920.810 64(9)*	950.85	0.194E-21	R(68) A
27	1917.594 13(20)	1946.12	0.599E-23	R(66) G	62	1920.944 58(13)*	1501.41	0.281E-22	R(69) C
28	1917.818 16(21)	1913.74	0.536E-23	R(65) F	63	1921.023 67(14)*	1586.72	0.192E-22	R(72) B
29	1917.831 45(13)*	1364.57	0.506E-22	R(64) B	64	1921.237 61(9)*	978.78	0.171E-21	R(69) A
30	1917.836 27(9)*	766.58	0.432E-21	R(61) A	65	1921.373 57(13)*	1529.81	0.248E-22	R(70) C
31	1917.950 64(13)*	1313.90	0.629E-22	R(62) C	66	1921.422 90(14)*	1616.30	0.168E-22	R(73) B
32	1917.987 78(9)	1124.52	0.547E-23	R(74) X	67	1921.659 39(13)	1412.21	0.226E-23	R(83) X
33	1918.193 28(21)	1967.62	0.420E-23	R(67) E	68	1921.665 11(9)*	1007.13	0.151E-21	R(70) A
34	1918.226 47(21)	1940.56	0.478E-23	R(66) F	69	1921.802 89(13)*	1558.62	0.218E-22	R(71) C
35	1918.230 41(13)*	1390.93	0.451E-22	R(65) B	70	1921.822 21(14)*	1646.29	0.147E-22	R(74) B

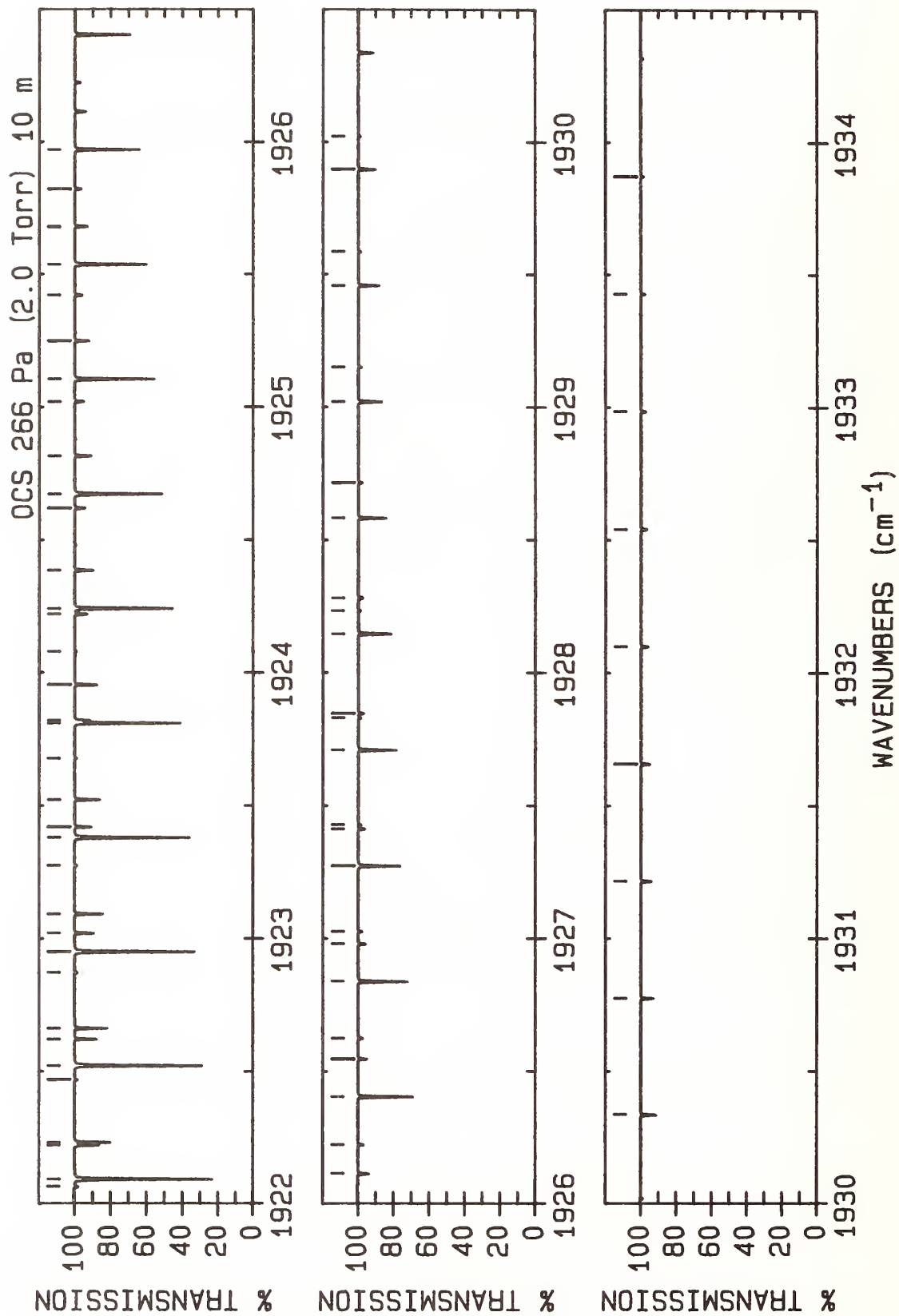

LINE #	WAVENUMBER(unc) (cm ⁻¹)	LOWER STATE (cm ⁻¹)	INTENSITY (cm/molecule)	ASSIGNMENT ROTATION BAND	LINE #	WAVENUMBER(unc) (cm ⁻¹)	LOWER STATE (cm ⁻¹)	INTENSITY (cm/molecule)	ASSIGNMENT ROTATION BAND
1	1922.064 38(14)	1446.18	0.202E-23	R(84) X	36	1925.971 06(9)*	1312.69	0.379E-22	R(80) A
2	1922.093 16(9)*	1035.87	0.133E-21	R(71) A	37	1926.113 81(14)*	1868.90	0.549E-23	R(81) C
3	1922.221 61(14)*	1676.68	0.129E-22	R(75) B	38	1926.223 54(14)*	2002.76	0.294E-23	R(85) B
4	1922.232 53(13)*	1587.83	0.192E-22	R(72) C	39	1926.404 86(9)*	1345.46	0.326E-22	R(81) A
5	1922.468 73(14)	1480.56	0.180E-23	R(85) X	40	1926.546 67(14)*	1902.14	0.472E-23	R(82) C
6	1922.521 76(9)*	1065.02	0.117E-21	R(72) A	41	1926.624 85(14)*	2037.58	0.251E-23	R(86) B
7	1922.621 11(14)*	1707.48	0.112E-22	R(76) B	42	1926.839 26(9)*	1378.63	0.280E-22	R(82) A
8	1922.662 50(14)*	1617.44	0.169E-22	R(73) C	43	1926.979 85(14)*	1935.79	0.406E-23	R(83) C
9	1922.872 41(15)	1515.34	0.159E-23	R(86) X	44	1927.026 43(14)*	2072.80	0.213E-23	R(87) B
10	1922.950 92(9)*	1094.57	0.102E-21	R(73) A	45	1927.274 25(9)*	1412.21	0.240E-22	R(83) A
11	1923.020 73(14)*	1738.67	0.974E-23	R(77) B	46	1927.413 34(14)*	1969.85	0.348E-23	R(84) C
12	1923.092 79(14)*	1647.46	0.148E-22	R(74) C	47	1927.428 29(14)*	2108.43	0.181E-23	R(88) B
13	1923.275 43(16)	1550.53	0.141E-23	R(87) X	48	1927.709 85(9)*	1446.18	0.205E-22	R(84) A
14	1923.380 64(9)*	1124.52	0.892E-22	R(74) A	49	1927.830 45(14)*	2144.46	0.153E-23	R(89) B
15	1923.420 48(14)*	1770.28	0.845E-23	R(78) B	50	1927.847 15(14)*	2004.30	0.297E-23	R(85) C
16	1923.523 40(14)*	1677.89	0.129E-22	R(75) C	51	1928.146 05(9)*	1480.56	0.175E-22	R(85) A
17	1923.677 76(17)	1586.11	0.124E-23	R(88) X	52	1928.232 93(14)*	2180.89	0.129E-23	R(90) B
18	1923.810 93(9)*	1154.87	0.778E-22	R(75) A	53	1928.281 28(14)*	2039.16	0.254E-23	R(86) C
19	1923.820 38(14)*	1802.28	0.732E-23	R(79) B	54	1928.582 86(9)*	1515.34	0.149E-22	R(86) A
20	1923.954 33(14)*	1708.71	0.112E-22	R(76) C	55	1928.715 72(14)*	2074.42	0.216E-23	R(87) C
21	1924.079 39(19)	1622.10	0.110E-23	R(89) X	56	1929.020 27(9)*	1550.53	0.126E-22	R(87) A
22	1924.220 43(14)*	1834.68	0.632E-23	R(80) B	57	1929.150 47(14)*	2110.08	0.184E-23	R(88) C
23	1924.241 79(9)*	1185.63	0.677E-22	R(76) A	58	1929.458 29(9)*	1586.11	0.107E-22	R(88) A
24	1924.385 59(14)*	1739.94	0.979E-23	R(77) C	59	1929.585 53(15)*	2146.15	0.156E-23	R(89) C
25	1924.620 65(14)*	1867.49	0.545E-23	R(81) B	60	1929.896 91(9)*	1622.10	0.906E-23	R(89) A
26	1924.673 23(9)*	1216.79	0.587E-22	R(77) A	61	1930.020 91(15)*	2182.61	0.132E-23	R(90) C
27	1924.817 16(14)*	1771.58	0.850E-23	R(78) C	62	1930.336 14(9)*	1658.48	0.764E-23	R(90) A
28	1925.021 05(14)*	1900.71	0.468E-23	R(82) B	63	1930.775 98(9)*	1695.27	0.643E-23	R(91) A
29	1925.105 25(9)*	1248.35	0.509E-22	R(78) A	64	1931.216 41(9)*	1732.46	0.540E-23	R(92) A
30	1925.249 06(14)*	1803.61	0.736E-23	R(79) C	65	1931.657 45(9)*	1770.05	0.453E-23	R(93) A
31	1925.421 66(14)*	1934.32	0.402E-23	R(83) B	66	1932.099 08(9)*	1808.05	0.379E-23	R(94) A
32	1925.537 86(9)*	1280.32	0.440E-22	R(79) A	67	1932.541 31(9)*	1846.44	0.316E-23	R(95) A
33	1925.678 70(24)	1770.05	0.638E-24	R(93) X	68	1932.984 12(9)*	1885.23	0.264E-23	R(96) A
34	1925.681 28(14)*	1836.05	0.636E-23	R(80) C	69	1933.427 53(9)*	1924.43	0.219E-23	R(97) A
35	1925.822 49(14)*	1968.34	0.344E-23	R(84) B	70	1933.871 51(9)*	1964.03	0.182E-23	R(98) A

ATLAS OF OCS ABSORPTION LINES FROM 1970 cm⁻¹ to 2141 cm⁻¹

key:

Band	Isotopomer	Vibrational Transition
A	¹⁶ O ¹² C ³² S	10 ⁰ 0-00 ⁰ 0
B		11 ¹ 0-01 ^{1e} 0
C		11 ¹ 0-01 ^{1f} 0
D		10 ⁰ 1-00 ⁰ 1
E		12 ² 0-02 ^{2e} 0
F		12 ² 0-02 ^{2f} 0
G		12 ⁰ 0-02 ⁰ 0
H		11 ¹ 1-01 ^{1e} 1
I		11 ¹ 1-01 ^{1f} 1
W		04 ⁰ 0-00 ⁰ 0
Y		05 ¹ 0-01 ^{1e} 0
Z		05 ¹ 0-01 ^{1f} 0
J	¹⁶ O ¹³ C ³⁴ S	10 ⁰ 0-00 ⁰ 0
K	¹⁸ O ¹² C ³² S	10 ⁰ 0-00 ⁰ 0
L	¹⁶ O ¹² C ³³ S	10 ⁰ 0-00 ⁰ 0
M		11 ¹ 0-01 ^{1e} 0
N		11 ¹ 0-01 ^{1f} 0
P	¹⁶ O ¹² C ³⁴ S	10 ⁰ 0-00 ⁰ 0
Q		11 ¹ 0-01 ^{1e} 0
R		11 ¹ 0-01 ^{1f} 0
S		10 ⁰ 1-00 ⁰ 1
T	¹⁶ O ¹³ C ³² S	10 ⁰ 0-00 ⁰ 0
U		11 ¹ 0-01 ^{1e} 0
V		11 ¹ 0-01 ^{1f} 0

If the e or f designation is not specified (for $l \neq 0$), then the transition is to either level, depending on the selection rules and the change in the rotational quantum number, J . Spectra are given for a slitwidth of 0.003 cm⁻¹, a temperature of 296 K, and transition moments of 0.345 debye for $\Delta v_1 = 1$ transitions, 0.024 debye for the W band, and 0.017 debye for the Y and Z bands. No Herman-Wallis constant was included in the intensity calculation.

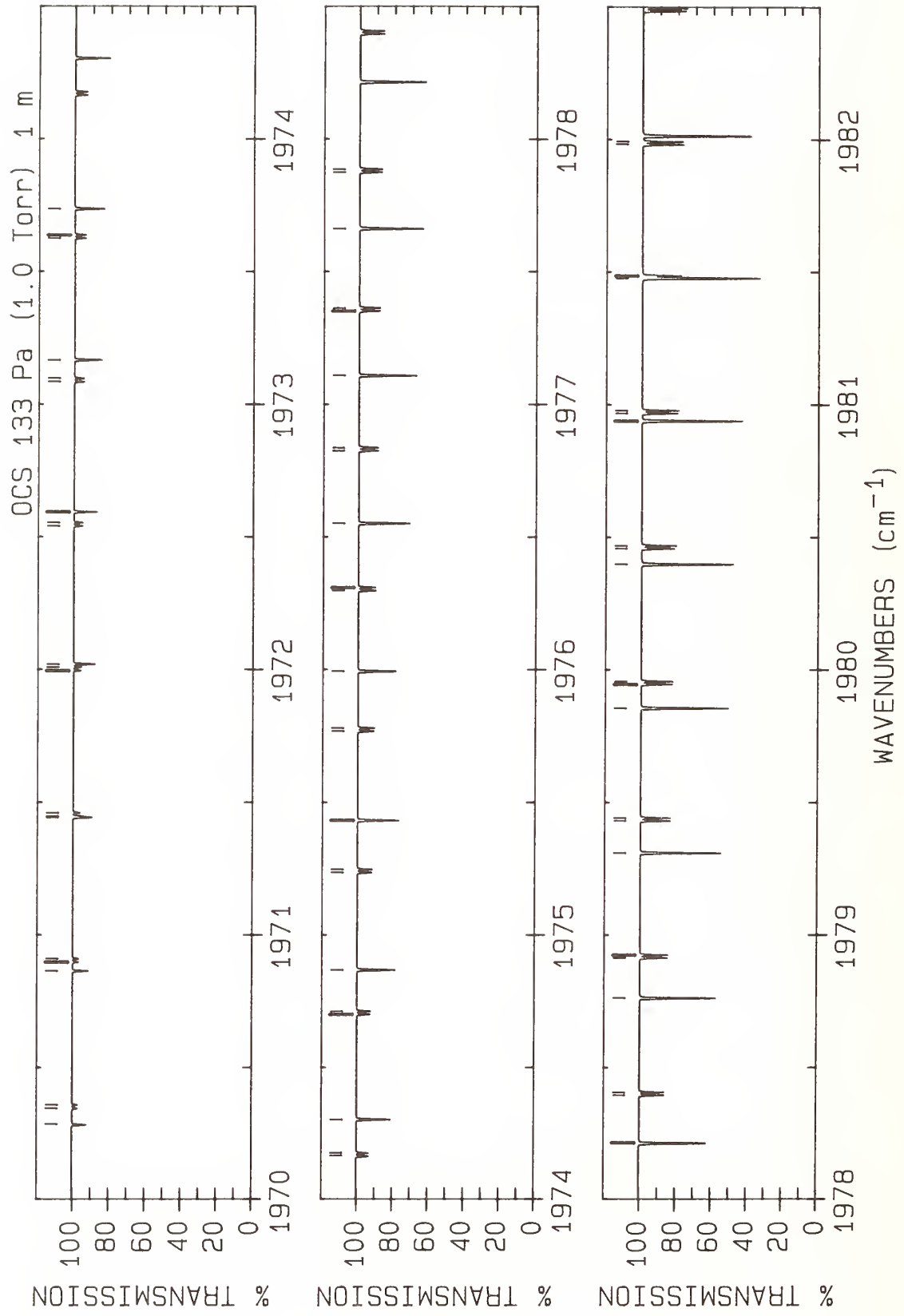

LINE #	WAVENUMBER(unc) (cm ⁻¹)	LOWER STATE (cm ⁻¹)	INTENSITY (cm/molecule)	ASSIGNMENT ROTATION BAND	LINE #	WAVENUMBER(unc) (cm ⁻¹)	LOWER STATE (cm ⁻¹)	INTENSITY (cm/molecule)	ASSIGNMENT ROTATION BAND
1	1970.283 26(58)	1276.20	0.132E-21	P(79) T	36	1976.550 89(19)*	947.79	0.564E-21	P(68) T
2	1970.345 31(52)	1427.35	0.539E-22	P(67) V	37	1976.825 33(20)	1128.74	0.190E-21	P(55) V
3	1970.358 44(57)	1426.37	0.542E-22	P(67) U	38	1976.836 59(21)	1128.07	0.190E-21	P(55) U
4	1970.864 20(52)	1244.34	0.153E-21	P(78) T	39	1977.107 24(18)*	920.34	0.635E-21	P(67) T
5	1970.897 53(48)	1400.25	0.606E-22	P(66) V	40	1977.350 89(18)	1106.48	0.207E-21	P(54) V
6	1970.910 46(52)	1399.29	0.609E-22	P(66) U	41	1977.362 03(19)	1105.84	0.208E-21	P(54) U
7	1971.442 91(47)	1212.88	0.176E-21	P(77) T	42	1977.661 34(17)*	893.30	0.714E-21	P(66) T
8	1971.447 53(44)	1373.55	0.680E-22	P(65) V	43	1977.874 23(17)	1084.62	0.226E-21	P(53) V
9	1971.460 26(48)	1372.62	0.683E-22	P(65) U	44	1977.885 26(18)	1084.00	0.227E-21	P(53) U
10	1971.995 31(40)	1347.26	0.761E-22	P(64) V	45	1978.213 20(17)*	866.66	0.800E-21	P(65) T
11	1972.007 85(44)	1346.35	0.764E-22	P(64) U	46	1978.395 34(17)	1063.17	0.247E-21	P(52) V
12	1972.019 40(42)	1181.82	0.202E-21	P(76) T	47	1978.406 27(17)	1062.57	0.247E-21	P(52) U
13	1972.540 87(37)	1321.36	0.850E-22	P(63) V	48	1978.762 80(16)*	840.42	0.895E-21	P(64) T
14	1972.553 24(41)	1320.49	0.853E-22	P(63) U	49	1978.914 23(16)	1042.12	0.268E-21	P(51) V
15	1972.593 66(37)	1151.16	0.231E-21	P(75) T	50	1978.925 06(16)	1041.54	0.269E-21	P(51) U
16	1973.084 21(34)	1295.87	0.946E-22	P(62) V	51	1979.310 16(16)*	814.58	0.100E-20	P(63) T
17	1973.096 40(37)	1295.03	0.950E-22	P(62) U	52	1979.430 90(15)	1021.47	0.291E-21	P(50) V
18	1973.165 69(34)	1120.90	0.264E-21	P(74) T	53	1979.441 63(15)	1020.92	0.291E-21	P(50) U
19	1973.625 32(32)	1270.79	0.105E-21	P(61) V	54	1979.855 26(16)*	789.15	0.111E-20	P(62) T
20	1973.637 36(34)	1269.97	0.106E-21	P(61) U	55	1979.945 35(15)	1001.23	0.314E-21	P(49) V
21	1973.735 49(30)	1091.04	0.301E-21	P(73) T	56	1979.955 98(15)	1000.70	0.315E-21	P(49) U
22	1974.164 21(29)	1246.10	0.117E-21	P(60) V	57	1980.398 11(15)*	764.12	0.124E-20	P(61) T
23	1974.176 10(31)	1245.31	0.117E-21	P(60) U	58	1980.457 57(14)	981.39	0.339E-21	P(48) V
24	1974.303 05(27)	1061.59	0.343E-21	P(72) T	59	1980.468 11(15)	980.88	0.340E-21	P(48) U
25	1974.700 88(27)	1221.82	0.129E-21	P(59) V	60	1980.938 70(15)*	739.49	0.137E-20	P(60) T
26	1974.712 63(29)	1221.06	0.130E-21	P(59) U	61	1980.967 58(14)	961.95	0.365E-21	P(47) V
27	1974.868 37(25)*	1032.54	0.390E-21	P(71) T	62	1980.978 02(14)	961.47	0.366E-21	P(47) U
28	1975.235 33(25)	1197.95	0.143E-21	P(58) V	63	1981.475 36(14)	942.92	0.392E-21	P(46) V
29	1975.246 94(26)	1197.21	0.143E-21	P(58) U	64	1981.477 04(15)*	715.26	0.152E-20	P(59) T
30	1975.431 45(23)*	1003.88	0.442E-21	P(70) T	65	1981.485 70(14)	942.46	0.393E-21	P(46) U
31	1975.767 55(23)	1174.48	0.157E-21	P(57) V	66	1981.980 91(14)	924.30	0.420E-21	P(45) V
32	1975.779 04(24)	1173.76	0.158E-21	P(57) U	67	1981.991 17(14)	923.85	0.421E-21	P(45) U
33	1975.992 29(21)*	975.63	0.500E-21	P(69) T					
34	1976.297 55(21)	1151.41	0.173E-21	P(56) V					
35	1976.308 92(22)	1150.71	0.173E-21	P(56) U					

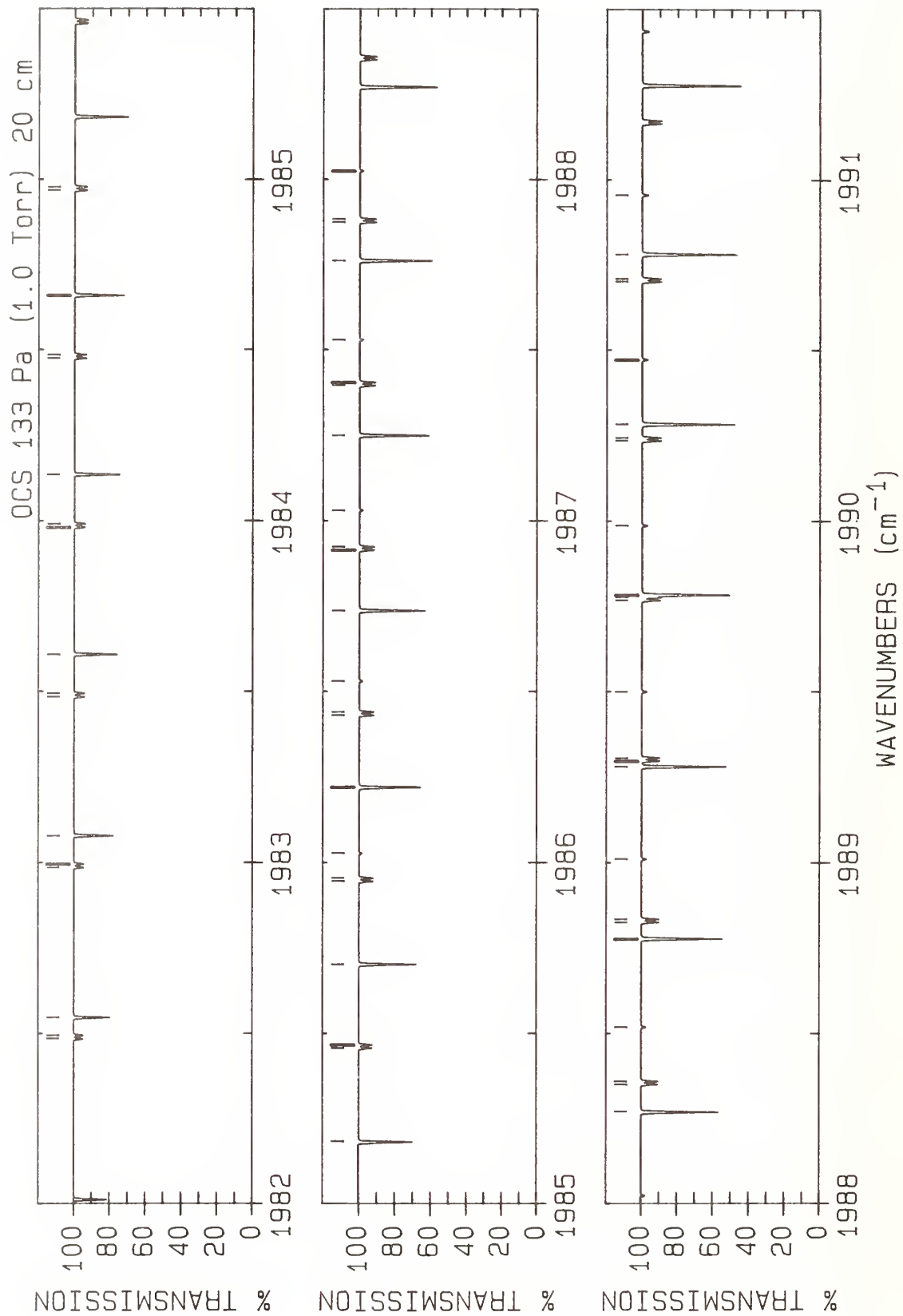

LINE #	WAVENUMBER(unc) (cm ⁻¹)	LOWER STATE (cm ⁻¹)	INTENSITY (cm/molecule)	ASSIGNMENT ROTATION BAND	LINE #	WAVENUMBER(unc) (cm ⁻¹)	LOWER STATE (cm ⁻¹)	INTENSITY (cm/molecule)	ASSIGNMENT ROTATION BAND
1	1982.484 25(14)	906.08	0.449E-21	P(44) V	36	1987.528 8	444.66	0.193E-21	P(47) J
2	1982.494 41(14)	905.65	0.450E-21	P(44) U	37	1987.760 86(15)*	455.95	0.428E-20	P(47) T
3	1982.546 95(15)*	668.01	0.185E-20	P(57) T	38	1987.874 27(13)	732.32	0.785E-21	P(33) V
4	1982.985 36(14)	888.26	0.478E-21	P(43) V	39	1987.883 21(13)	732.08	0.786E-21	P(33) U
5	1982.995 43(14)	887.85	0.479E-21	P(43) U	40	1988.024 8	426.14	0.207E-21	P(46) J
6	1983.078 51(15)*	644.99	0.203E-20	P(56) T	41	1988.269 81(15)*	436.96	0.460E-20	P(46) T
7	1983.484 26(14)	870.84	0.509E-21	P(42) V	42	1988.350 93(13)	718.95	0.812E-21	P(32) V
8	1983.494 22(14)	870.45	0.510E-21	P(42) U	43	1988.359 74(13)	718.73	0.813E-21	P(32) U
9	1983.607 82(15)*	622.38	0.223E-20	P(55) T	44	1988.518 6	408.01	0.221E-21	P(45) J
10	1983.980 92(14)	853.84	0.539E-21	P(41) V	45	1988.776 49(15)*	418.38	0.492E-20	P(45) T
11	1983.990 79(14)	853.46	0.540E-21	P(41) U	46	1988.825 37(13)	705.99	0.838E-21	P(31) V
12	1984.134 87(15)*	600.16	0.243E-20	P(54) T	47	1988.834 04(13)	705.77	0.839E-21	P(31) U
13	1984.475 37(14)	837.23	0.571E-21	P(40) V	48	1989.010 2	390.28	0.236E-21	P(44) J
14	1984.485 13(14)	836.87	0.572E-21	P(40) U	49	1989.280 91(15)*	400.19	0.526E-20	P(44) T
15	1984.659 65(15)*	578.35	0.266E-20	P(53) T	50	1989.297 59(13)	693.43	0.863E-21	P(30) V
16	1984.967 60(13)	821.03	0.602E-21	P(39) V	51	1989.306 11(13)	693.23	0.863E-21	P(30) U
17	1984.977 25(13)	820.69	0.603E-21	P(39) U	52	1989.499 5	372.94	0.251E-21	P(43) J
18	1985.182 18(15)*	556.95	0.290E-20	P(52) T	53	1989.767 58(13)	681.28	0.885E-21	P(29) V
19	1985.457 60(13)	805.23	0.634E-21	P(38) V	54	1989.775 95(13)	681.09	0.885E-21	P(29) U
20	1985.467 15(13)	804.91	0.635E-21	P(38) U	55	1989.783 06(15)*	382.42	0.560E-20	P(43) T
21	1985.702 44(15)*	535.94	0.315E-20	P(51) T	56	1989.986 7	356.00	0.266E-21	P(42) J
22	1985.945 38(13)	789.84	0.665E-21	P(37) V	57	1990.235 35(13)	669.53	0.905E-21	P(28) V
23	1985.954 81(13)	789.54	0.666E-21	P(37) U	58	1990.243 56(13)	669.35	0.905E-21	P(28) U
24	1986.027 5	502.58	0.155E-21	P(50) J	59	1990.282 94(15)*	365.04	0.596E-20	P(42) T
25	1986.220 44(15)*	515.34	0.341E-20	P(50) T	60	1990.471 7	339.45	0.282E-21	P(41) J
26	1986.430 93(13)	774.86	0.696E-21	P(36) V	61	1990.700 90(13)	658.18	0.922E-21	P(27) V
27	1986.440 25(13)	774.57	0.697E-21	P(36) U	62	1990.708 93(13)	658.02	0.923E-21	P(27) U
28	1986.530 1	482.88	0.167E-21	P(49) J	63	1990.780 56(14)*	348.07	0.632E-20	P(41) T
29	1986.736 18(15)*	495.14	0.369E-20	P(49) T	64	1990.954 4	323.29	0.297E-21	P(40) J
30	1986.914 27(13)	760.27	0.726E-21	P(35) V					
31	1986.923 47(13)	760.00	0.727E-21	P(35) U					
32	1987.030 5	463.57	0.180E-21	P(48) J					
33	1987.249 65(15)*	475.34	0.398E-20	P(48) T					
34	1987.395 38(13)	746.10	0.756E-21	P(34) V					
35	1987.404 45(13)	745.84	0.757E-21	P(34) U					

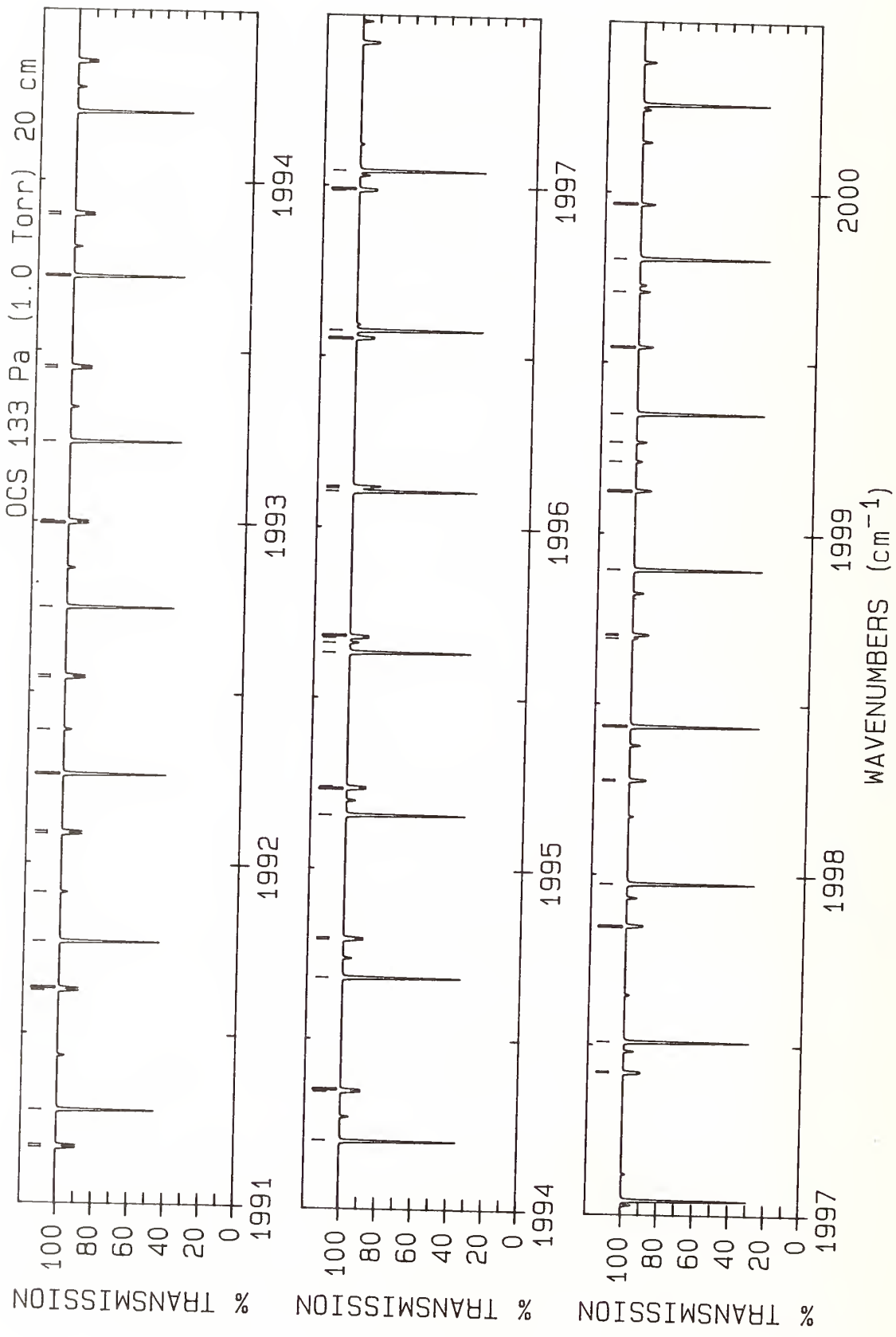

LINE #	WAVENUMBER(unc) (cm ⁻¹)	LOWER STATE (cm ⁻¹)	INTENSITY (cm/molecule)	ASSIGNMENT ROTATION BAND	LINE #	WAVENUMBER(unc) (cm ⁻¹)	LOWER STATE (cm ⁻¹)	INTENSITY (cm/molecule)	ASSIGNMENT ROTATION BAND	LINE #	WAVENUMBER(unc) (cm ⁻¹)	LOWER STATE (cm ⁻¹)	INTENSITY (cm/molecule)	ASSIGNMENT ROTATION BAND
1	1991.164 22(13)	647.25	0.936E-21	P(26)	V	36	1996.104 75(14)*	188.01	0.101E-19	P(30)	T			
2	1991.172 08(13)	647.09	0.937E-21	P(26)	U	37	1996.113 80(13)	553.64	0.851E-21	P(15)	V			
3	1991.275 92(14)*	331.50	0.668E-20	P(40)	T	38	1996.119 17(13)	553.59	0.851E-21	P(15)	U			
4	1991.625 31(13)	636.71	0.948E-21	P(25)	V	39	1996.119 2	171.53	0.452E-21	P(29)	J			
5	1991.632 99(13)	636.57	0.948E-21	P(25)	U	40	1996.550 40(14)	547.56	0.818E-21	P(14)	V			
6	1991.769 00(14)*	315.33	0.705E-20	P(39)	T	41	1996.555 48(13)	547.52	0.818E-21	P(14)	U			
7	1991.913 4	292.15	0.329E-21	P(38)	J	42	1996.575 16(14)*	175.88	0.104E-19	P(29)	T			
8	1992.084 18(13)	626.58	0.956E-21	P(24)	V	43	1996.575 5	160.09	0.461E-21	P(28)	J			
9	1992.091 67(13)	626.45	0.956E-21	P(24)	U	44	1996.984 76(14)	541.89	0.780E-21	P(13)	V			
10	1992.259 82(14)*	299.57	0.742E-20	P(38)	T	45	1996.989 55(14)	541.85	0.780E-21	P(13)	U			
11	1992.389 5	277.17	0.344E-21	P(37)	J	46	1997.043 30(14)*	164.16	0.106E-19	P(28)	T			
12	1992.540 83(13)	616.86	0.960E-21	P(23)	V	47	1997.416 89(14)	536.62	0.738E-21	P(12)	V			
13	1992.548 11(13)	616.74	0.961E-21	P(23)	U	48	1997.421 37(14)	536.59	0.738E-21	P(12)	U			
14	1992.748 38(14)*	284.21	0.778E-20	P(37)	T	49	1997.509 17(14)*	152.84	0.108E-19	P(27)	T			
15	1992.995 24(13)	607.54	0.961E-21	P(22)	V	50	1997.846 79(14)	531.76	0.692E-21	P(11)	V			
16	1993.002 32(13)	607.43	0.962E-21	P(22)	U	51	1997.850 96(14)	531.73	0.692E-21	P(11)	U			
17	1993.234 66(14)*	269.26	0.815E-20	P(36)	T	52	1997.972 77(14)*	141.93	0.109E-19	P(26)	T			
18	1993.447 44(13)	598.62	0.958E-21	P(21)	V	53	1998.274 45(14)	527.30	0.642E-21	P(10)	V			
19	1993.454 30(13)	598.52	0.959E-21	P(21)	U	54	1998.278 30(14)	527.28	0.642E-21	P(10)	U			
20	1993.718 68(14)*	254.71	0.850E-20	P(35)	T	55	1998.434 10(14)*	131.41	0.111E-19	P(25)	T			
21	1993.897 40(13)	590.11	0.951E-21	P(20)	V	56	1998.691 3	719.15	0.269E-21	P(61)	K			
22	1993.904 04(13)	590.02	0.952E-21	P(20)	U	57	1998.699 88(14)	523.25	0.588E-21	P(9)	V			
23	1994.200 43(14)*	240.56	0.885E-20	P(34)	T	58	1998.703 39(14)	523.23	0.588E-21	P(9)	U			
24	1994.345 14(13)	582.01	0.940E-21	P(19)	V	59	1998.893 16(14)*	121.31	0.112E-19	P(24)	T			
25	1994.351 54(13)	581.93	0.940E-21	P(19)	U	60	1999.123 08(14)	519.60	0.530E-21	P(8)	V			
26	1994.679 91(14)*	226.82	0.919E-20	P(33)	T	61	1999.126 25(14)	519.58	0.530E-21	P(8)	U			
27	1994.790 65(13)	574.31	0.924E-21	P(18)	V	62	1999.210 3	695.97	0.297E-21	P(60)	K			
28	1994.796 80(13)	574.24	0.925E-21	P(18)	U	63	1999.266 9	99.77	0.487E-21	P(22)	J			
29	1995.157 13(14)*	213.48	0.951E-20	P(32)	T	64	1999.349 94(14)*	111.60	0.112E-19	P(23)	T			
30	1995.233 93(13)	567.01	0.904E-21	P(17)	V	65	1999.544 04(14)	516.36	0.469E-21	P(7)	V			
31	1995.239 83(13)	566.95	0.905E-21	P(17)	U	66	1999.546 85(14)	516.35	0.469E-21	P(7)	U			
32	1995.632 07(14)*	200.54	0.981E-20	P(31)	T	67	1999.707 7	91.09	0.485E-21	P(21)	J			
33	1995.660 7	183.35	0.441E-21	P(30)	J	68	1999.804 46(14)*	102.30	0.113E-19	P(22)	T			
34	1995.674 98(13)	560.13	0.880E-21	P(16)	V	69	1999.962 77(14)	513.52	0.405E-21	P(6)	V			
35	1995.680 62(13)	560.07	0.880E-21	P(16)	U	70	1999.965 21(14)	513.51	0.405E-21	P(6)	U			

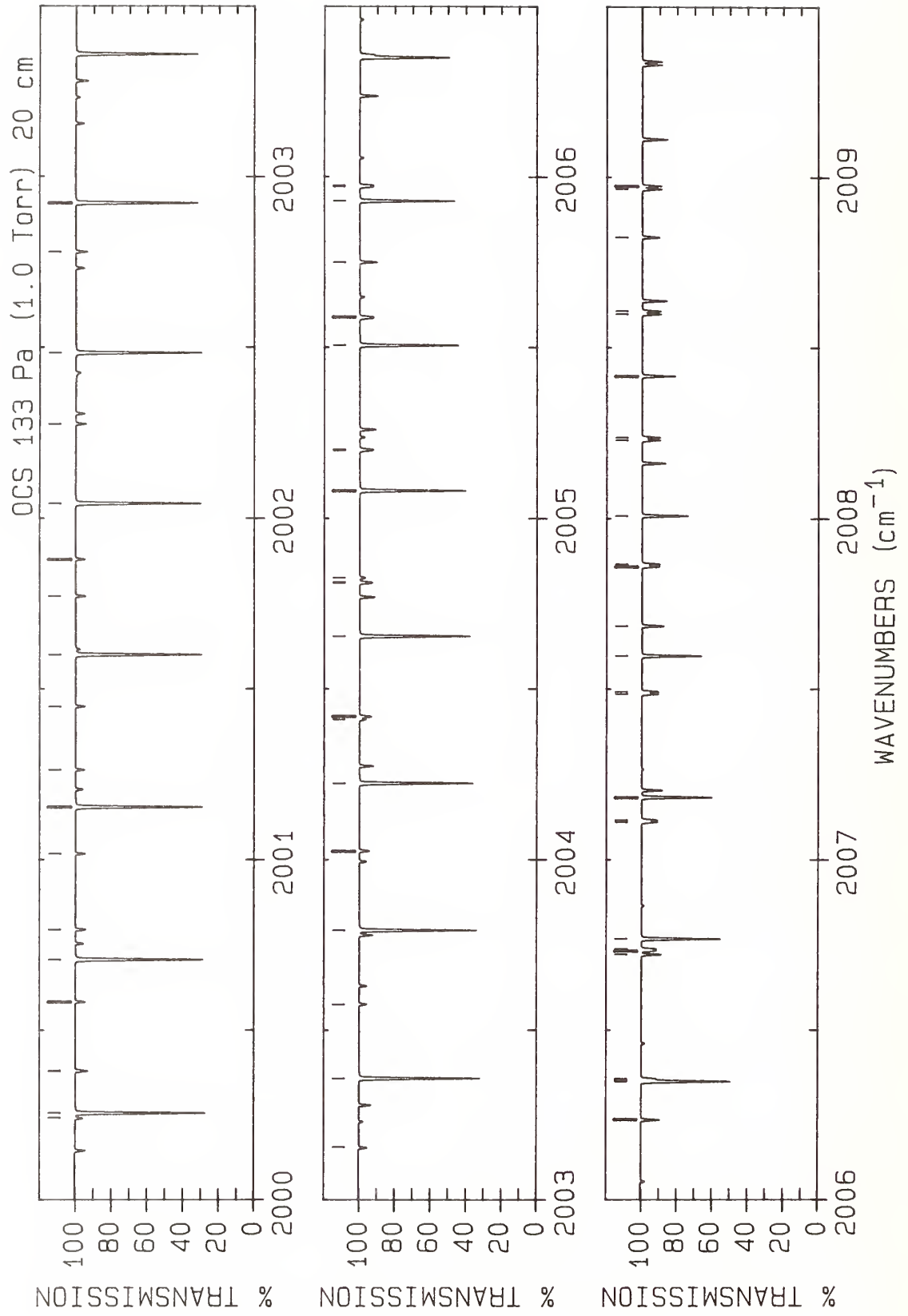

LINE #	WAVENUMBER(unc) (cm ⁻¹)	LOWER STATE (cm ⁻¹)	INTENSITY (cm/molecule)	ASSIGNMENT ROTATION BAND	LINE #	WAVENUMBER(unc) (cm ⁻¹)	LOWER STATE (cm ⁻¹)	INTENSITY (cm/molecule)	ASSIGNMENT ROTATION BAND
1	2000.241 4	650.74	0.358E-21	P(58) K	36	2005.198 96(14)	513.51	0.477E-21	R(6) U
2	2000.256 71(14)*	93.41	0.112E-19	P(21) T	37	2005.202 31(14)	513.52	0.477E-21	R(6) V
3	2000.379 26(14)	511.09	0.337E-21	P(5) V	38	2005.506 30(14)*	18.20	0.694E-20	P(9) T
4	2000.381 32(14)	511.08	0.337E-21	P(5) U	39	2005.585 75(14)	516.35	0.540E-21	R(7) U
5	2000.582 8	74.93	0.475E-21	P(19) J	40	2005.589 62(14)	516.36	0.540E-21	R(7) V
6	2000.706 68(14)*	84.92	0.111E-19	P(20) T	41	2005.749 6	429.11	0.853E-21	P(47) K
7	2000.793 51(14)	509.06	0.266E-21	P(4) V	42	2005.928 97(14)*	14.56	0.628E-20	P(8) T
8	2000.795 18(14)	509.06	0.266E-21	P(4) U	43	2005.970 29(14)	519.58	0.601E-21	R(8) U
9	2001.017 0	67.44	0.466E-21	P(18) J	44	2005.974 69(14)	519.60	0.601E-21	R(8) V
10	2001.154 38(14)*	76.83	0.110E-19	P(19) T	45	2006.236 7	411.24	0.911E-21	P(46) K
11	2001.263 4	607.03	0.427E-21	P(56) K	46	2006.349 36(14)*	11.32	0.559E-20	P(7) T
12	2001.449 0	60.34	0.456E-21	P(17) J	47	2006.352 55(14)	523.23	0.657E-21	R(9) U
13	2001.599 81(14)*	69.15	0.108E-19	P(18) T	48	2006.357 50(14)	523.25	0.657E-21	R(9) V
14	2001.771 0	585.75	0.465E-21	P(55) K	49	2006.721 4	393.75	0.971E-21	P(45) K
15	2001.878 8	53.63	0.444E-21	P(16) J	50	2006.732 56(14)	527.28	0.710E-21	R(10) U
16	2002.042 96(14)*	61.87	0.106E-19	P(17) T	51	2006.738 06(14)	527.30	0.710E-21	R(10) V
17	2002.276 4	564.84	0.506E-21	P(54) K	52	2006.767 46(14)*	8.49	0.486E-20	P(6) T
18	2002.483 84(14)*	55.00	0.103E-19	P(16) T	53	2007.110 29(14)	531.73	0.760E-21	R(11) U
19	2002.779 4	544.31	0.549E-21	P(53) K	54	2007.116 36(14)	531.76	0.759E-21	R(11) V
20	2002.922 45(14)*	48.53	0.997E-20	P(15) T	55	2007.183 29(14)*	6.07	0.410E-20	P(5) T
21	2003.155 0	35.89	0.393E-21	P(13) J	56	2007.485 76(13)	536.59	0.805E-21	R(12) U
22	2003.358 78(14)*	42.46	0.959E-20	P(14) T	57	2007.492 40(13)	536.62	0.804E-21	R(12) V
23	2003.575 9	30.76	0.372E-21	P(12) J	58	2007.596 84(14)*	4.04	0.331E-20	P(4) T
24	2003.792 84(14)*	36.80	0.915E-20	P(13) T	59	2007.684 0	359.90	0.109E-20	P(43) K
25	2004.025 00(14)	507.44	0.269E-21	R(3) U	60	2007.858 96(13)	541.85	0.845E-21	R(13) U
26	2004.026 85(14)	507.44	0.269E-21	R(3) V	61	2007.866 18(13)	541.89	0.845E-21	R(13) V
27	2004.224 62(14)*	31.54	0.867E-20	P(12) T	62	2008.008 10(14)*	2.43	0.250E-20	P(3) T
28	2004.411 2	21.69	0.324E-21	P(10) J	63	2008.229 89(13)	547.52	0.882E-21	R(14) U
29	2004.418 58(14)	509.06	0.341E-21	R(4) U	64	2008.237 71(13)	547.56	0.882E-21	R(14) V
30	2004.420 92(14)	509.06	0.341E-21	R(4) V	65	2008.417 08(14)*	1.21	0.168E-20	P(2) T
31	2004.654 12(14)*	26.69	0.814E-20	P(11) T	66	2008.598 55(13)	553.59	0.914E-21	R(15) U
32	2004.809 90(14)	511.08	0.411E-21	R(5) U	67	2008.606 97(13)	553.64	0.914E-21	R(15) V
33	2004.812 74(14)	511.09	0.410E-21	R(5) V	68	2008.823 77(14)*	0.40	0.843E-21	P(1) T
34	2004.825 6	17.75	0.298E-21	P(9) J	69	2008.964 93(13)	560.07	0.942E-21	R(16) U
35	2005.081 35(14)*	22.24	0.756E-20	P(10) T	70	2008.973 96(13)	560.13	0.941E-21	R(16) V

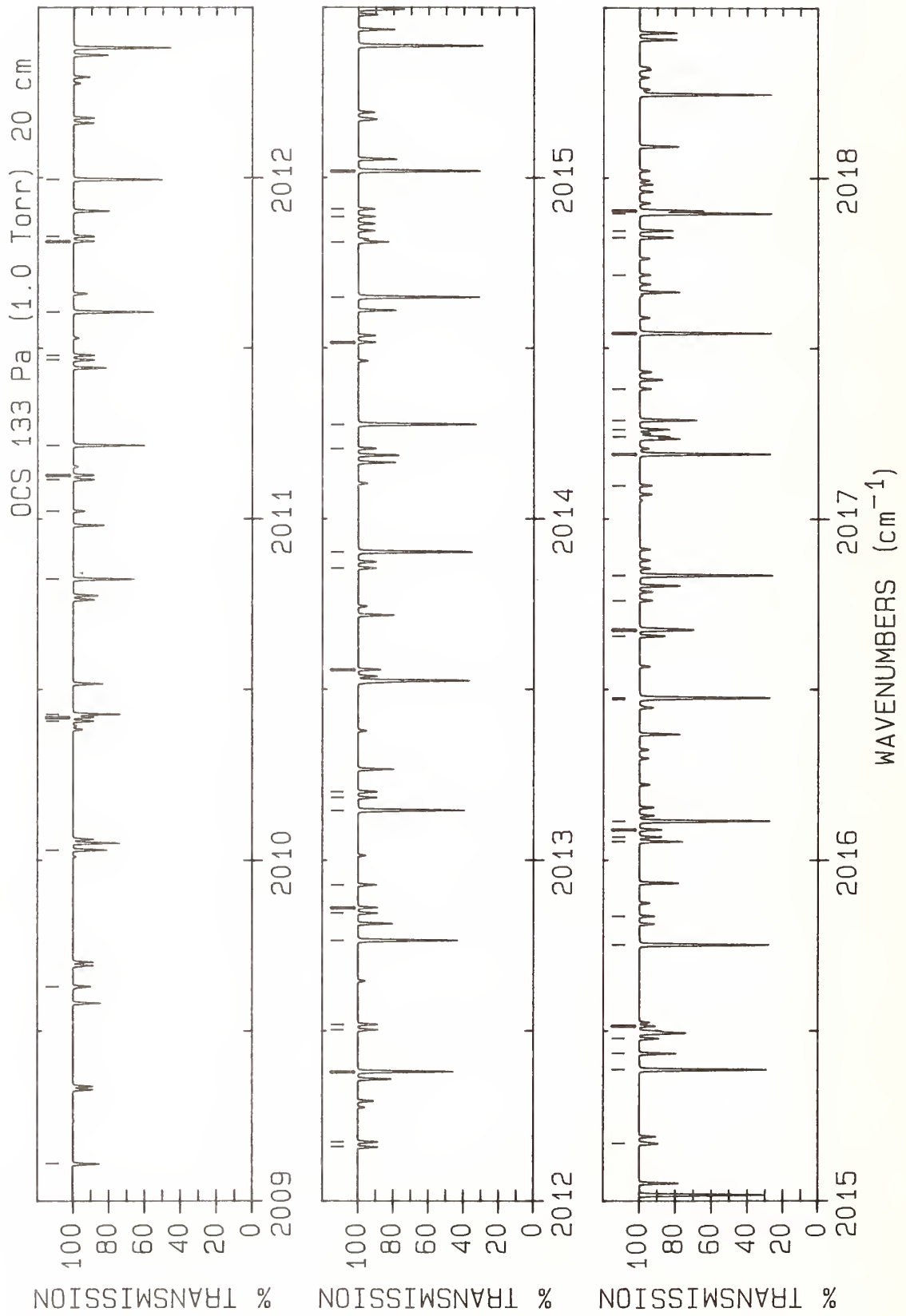

LINE #	WAVENUMBER(cm^{-1})	LOWER STATE (cm^{-1})	INTENSITY ($\text{cm}^2/\text{molecule}$)	ASSIGNMENT ROTATION BAND	LINE #	WAVENUMBER(unc) (cm^{-1})	LOWER STATE (cm^{-1})	INTENSITY ($\text{cm}^2/\text{molecule}$)	ASSIGNMENT ROTATION BAND
1	2009.110 7	311.98	0.129E-20	P(40) K	36	2014.649 22(14)*	36.80	0.99IE-20	R(13) T
2	2009.630 30(14)*	0.00	0.845E-21	R(0) T	37	2014.811 28(13)*	1732.46	0.156E-20	P(92) A
3	2010.030 14(14)*	0.40	0.169E-20	R(1) T	38	2014.885 63(18)*	1836.05	0.820E-21	P(80) C
4	2010.407 70(13)	590.02	0.101E-20	R(20) U	39	2014.907 69(19)*	1834.68	0.826E-21	P(80) B
5	2010.419 28(13)	590.11	0.101E-20	R(20) V	40	2015.019 20(14)*	42.46	0.103E-19	R(14) T
6	2010.427 68(14)*	1.21	0.252E-20	R(2) T	41	2015.169 44(13)	745.84	0.790E-21	R(34) U
7	2010.822 93(14)*	2.43	0.334E-20	R(3) T	42	2015.386 87(14)*	48.53	0.107E-19	R(15) T
8	2011.022 72(15)	1964.03	0.538E-21	P(98) A	43	2015.434 53(13)*	1695.27	0.185E-20	P(91) A
9	2011.115 41(13)	607.43	0.101E-20	R(22) U	44	2015.478 25(17)*	1803.61	0.949E-21	P(79) C
10	2011.128 32(13)	607.54	0.101E-20	R(22) V	45	2015.514 55(13)	760.27	0.758E-21	R(35) V
11	2011.215 89(14)*	4.04	0.414E-20	R(4) T	46	2015.752 23(14)*	55.00	0.110E-19	R(16) T
12	2011.465 84(13)	616.74	0.101E-20	R(23) U	47	2015.835 91(13)	774.86	0.726E-21	R(36) V
13	2011.479 42(13)	616.86	0.101E-20	R(23) V	48	2016.055 44(13)*	1658.48	0.219E-20	P(90) A
14	2011.606 56(14)*	6.07	0.493E-20	R(5) T	49	2016.068 55(15)*	1771.58	0.110E-20	P(78) C
15	2011.813 99(13)	626.45	0.101E-20	R(24) U	50	2016.089 90(16)*	1770.28	0.110E-20	P(78) B
16	2011.828 25(13)	626.58	0.101E-20	R(24) V	51	2016.115 28(14)*	61.87	0.113E-19	R(17) T
17	2011.994 94(14)*	8.49	0.568E-20	R(6) T	52	2016.471 72(14)	805.23	0.660E-21	R(38) V
18	2012.159 85(13)	636.57	0.997E-21	R(25) U	53	2016.476 02(14)*	69.15	0.115E-19	R(18) T
19	2012.174 80(13)	636.71	0.996E-21	R(25) V	54	2016.656 53(14)*	1739.94	0.126E-20	P(77) C
20	2012.381 02(14)*	11.32	0.640E-20	R(7) T	55	2016.674 00(13)*	1622.10	0.258E-20	P(89) A
21	2012.503 42(13)	647.09	0.983E-21	R(26) U	56	2016.677 54(15)*	1738.67	0.127E-20	P(77) B
22	2012.519 07(13)	647.25	0.983E-21	R(26) V	57	2016.760 95(14)	820.69	0.628E-21	R(39) U
23	2012.764 80(14)*	14.56	0.709E-20	R(8) T	58	2016.834 45(14)*	76.83	0.117E-19	R(19) T
24	2012.844 70(13)	658.02	0.967E-21	R(27) U	59	2017.098 31(14)	837.23	0.595E-21	R(40) V
25	2012.861 06(13)	658.18	0.967E-21	R(27) V	60	2017.190 56(14)*	84.92	0.118E-19	R(20) T
26	2012.927 50(13)*	1846.44	0.924E-21	P(95) A	61	2017.242 18(13)*	1708.71	0.145E-20	P(76) C
27	2013.146 29(14)*	18.20	0.775E-20	R(9) T	62	2017.262 87(14)*	1707.48	0.146E-20	P(76) B
28	2013.183 69(13)	669.35	0.949E-21	R(28) U	63	2017.290 22(13)*	1586.11	0.304E-20	P(88) A
29	2013.200 76(13)	669.53	0.948E-21	R(28) V	64	2017.381 39(14)	853.46	0.563E-21	R(41) U
30	2013.557 77(13)*	1808.05	0.110E-20	P(94) A	65	2017.544 35(14)*	93.41	0.119E-19	R(21) T
31	2013.854 80(13)	693.23	0.903E-21	R(30) U	66	2017.715 66(14)	870.84	0.530E-21	R(42) V
32	2013.902 36(14)*	26.69	0.892E-20	R(11) T	67	2017.825 51(13)*	1677.89	0.166E-20	P(75) C
33	2014.206 14(13)	705.99	0.876E-21	R(31) V	68	2017.845 88(13)*	1676.68	0.167E-20	P(75) B
34	2014.276 94(14)*	31.54	0.944E-20	R(12) T	69	2017.895 83(14)*	102.30	0.119E-19	R(22) T
35	2014.516 72(13)	718.73	0.850E-21	R(32) U	70	2017.904 10(13)*	1550.53	0.357E-20	P(87) A

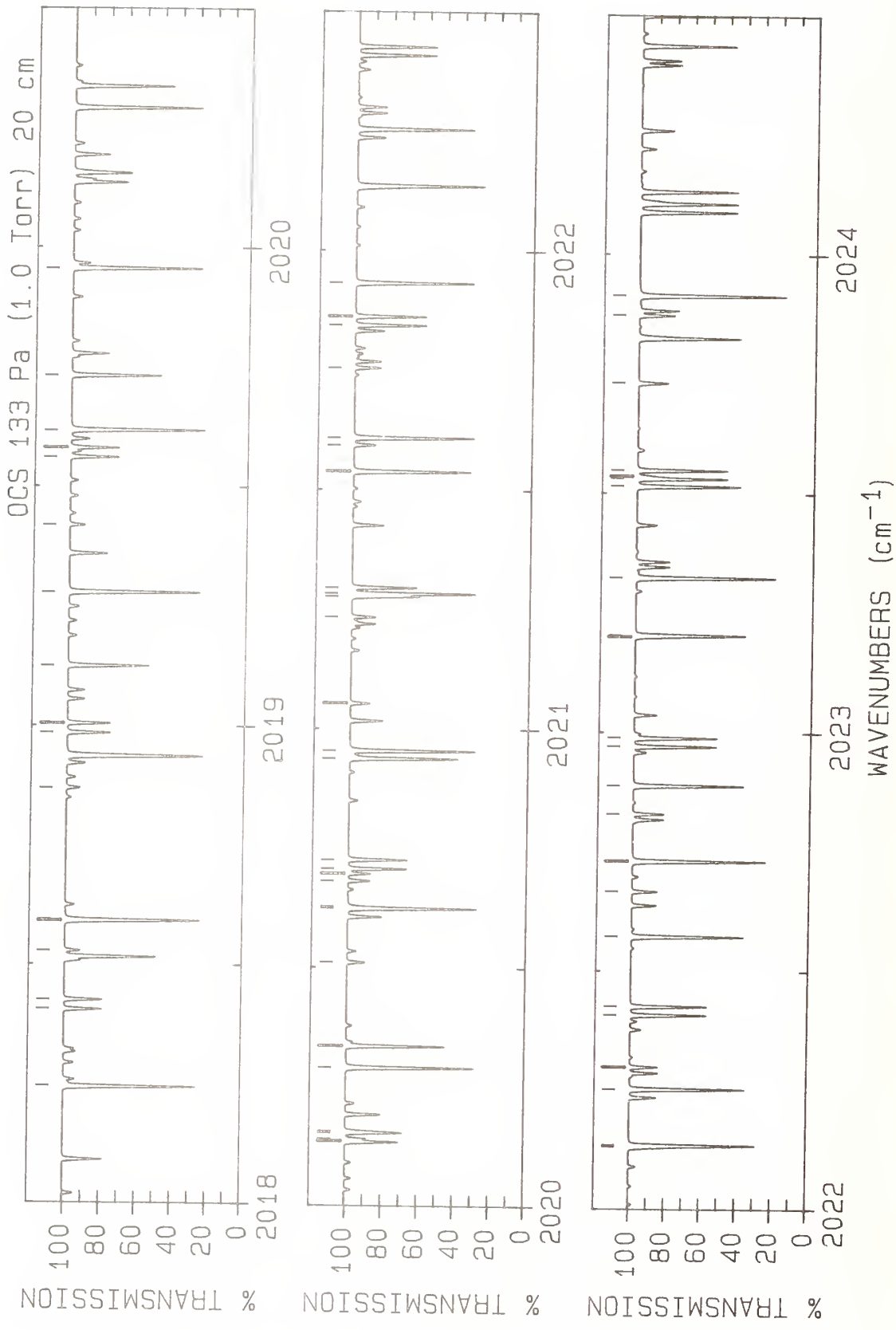

LINE #	WAVENUMBER(unc) (cm ⁻¹)	LOWER STATE (cm ⁻¹)	INTENSITY (cm/molecule)	ASSIGNMENT ROTATION BAND	LINE #	WAVENUMBER(unc) (cm ⁻¹)	LOWER STATE (cm ⁻¹)	INTENSITY (cm/molecule)	ASSIGNMENT ROTATION BAND
1	2018.244 99(14)*	111.60	0.118E-19	R(23)	36	2021.233 41(21)	1690.52	0.117E-20	P(56)
2	2018.406 51(12)*	1647.46	0.190E-20	P(74)	37	2021.276 58(11)*	1501.41	0.361E-20	P(69)
3	2018.426 57(13)*	1646.29	0.191E-20	P(74)	38	2021.282 74(14)*	213.48	0.993E-20	R(32)
4	2018.528 56(32)	1810.40	0.710E-21	P(61)	39	2021.295 22(11)*	1500.39	0.363E-20	P(69)
5	2018.591 7	149.06	0.492E-21	R(27)	40	2021.538 03(13)*	1345.46	0.903E-20	P(81)
6	2018.591 83(14)*	121.31	0.118E-19	R(24)	41	2021.593 49(11)	1719.35	0.104E-20	P(57)
7	2018.594 51(15)	923.85	0.438E-21	R(45)	42	2021.608 60(14)*	226.82	0.959E-20	R(33)
8	2018.869 67(15)	1841.28	0.622E-21	P(62)	43	2021.754 31(20)	1667.83	0.128E-20	P(55)
9	2018.985 18(12)*	1617.44	0.217E-20	P(73)	44	2021.843 59(11)*	1473.41	0.408E-20	P(68)
10	2019.004 95(12)*	1616.30	0.218E-20	P(73)	45	2021.861 98(11)*	1472.41	0.410E-20	P(68)
11	2019.124 81(13)*	1480.56	0.491E-20	P(85)	46	2021.932 13(14)*	240.56	0.924E-20	R(34)
12	2019.278 53(14)*	141.93	0.115E-19	R(26)	47	2022.131 19(11)	1696.18	0.114E-20	P(56)
13	2019.419 15(13)	1816.08	0.692E-21	P(61)	48	2022.135 45(13)*	1312.69	0.105E-19	P(80)
14	2019.561 53(11)*	1587.83	0.247E-20	P(72)	49	2022.253 31(14)*	254.71	0.887E-20	R(35)
15	2019.581 00(12)*	1586.72	0.249E-20	P(72)	50	2022.299 59(18)	1645.40	0.140E-20	P(54)
16	2019.617 23(27)	1761.24	0.873E-21	P(59)	51	2022.408 27(11)*	1445.81	0.460E-20	P(67)
17	2019.618 39(14)*	152.84	0.113E-19	R(27)	52	2022.426 40(11)*	1444.85	0.462E-20	P(67)
18	2019.731 65(13)*	1446.18	0.574E-20	P(84)	53	2022.572 15(14)*	269.26	0.850E-20	R(36)
19	2019.955 93(14)*	164.16	0.111E-19	R(28)	54	2022.666 53(11)	1673.42	0.125E-20	P(55)
20	2020.135 54(11)*	1558.62	0.281E-20	P(71)	55	2022.730 51(13)*	1280.32	0.121E-19	P(79)
21	2020.141 88(25)	1737.35	0.964E-21	P(58)	56	2022.829 30(17)	1623.45	0.153E-20	P(53)
22	2020.154 73(11)*	1557.54	0.283E-20	P(71)	57	2022.888 65(14)*	284.21	0.812E-20	R(37)
23	2020.158 21(24)	1737.26	0.964E-21	P(58)	58	2022.970 62(11)*	1418.62	0.517E-20	P(66)
24	2020.291 13(14)*	175.88	0.108E-19	R(29)	59	2022.988 50(11)*	1417.69	0.519E-20	P(66)
25	2020.336 13(13)*	1412.21	0.669E-20	P(83)	60	2023.199 53(11)	1651.06	0.137E-20	P(54)
26	2020.511 03(12)	1766.91	0.850E-21	P(59)	61	2023.202 79(14)*	299.57	0.773E-20	R(38)
27	2020.624 00(14)*	188.01	0.106E-19	R(30)	62	2023.323 21(13)*	1248.35	0.140E-19	P(78)
28	2020.628 09(20)	1062.57	0.257E-21	R(52)	63	2023.514 59(15)*	315.33	0.735E-20	R(39)
29	2020.681 66(23)	1713.77	0.106E-20	P(57)	64	2023.530 63(11)*	1391.83	0.580E-20	P(65)
30	2020.696 93(22)	1713.69	0.106E-20	P(57)	65	2023.535 83(20)	1217.87	0.699E-21	P(78)
31	2020.707 22(11)*	1529.81	0.319E-20	P(70)	66	2023.548 27(11)*	1390.93	0.583E-20	P(65)
32	2020.726 14(11)*	1528.76	0.321E-20	P(70)	67	2023.730 18(10)	1629.11	0.150E-20	P(53)
33	2020.938 25(13)*	1378.63	0.778E-20	P(82)	68	2023.871 94(15)	1580.82	0.182E-20	P(51)
34	2020.954 54(14)*	200.54	0.103E-19	R(31)	69	2023.913 55(12)*	1216.79	0.161E-19	P(77)
35	2021.053 44(12)	1742.93	0.940E-21	P(58)					

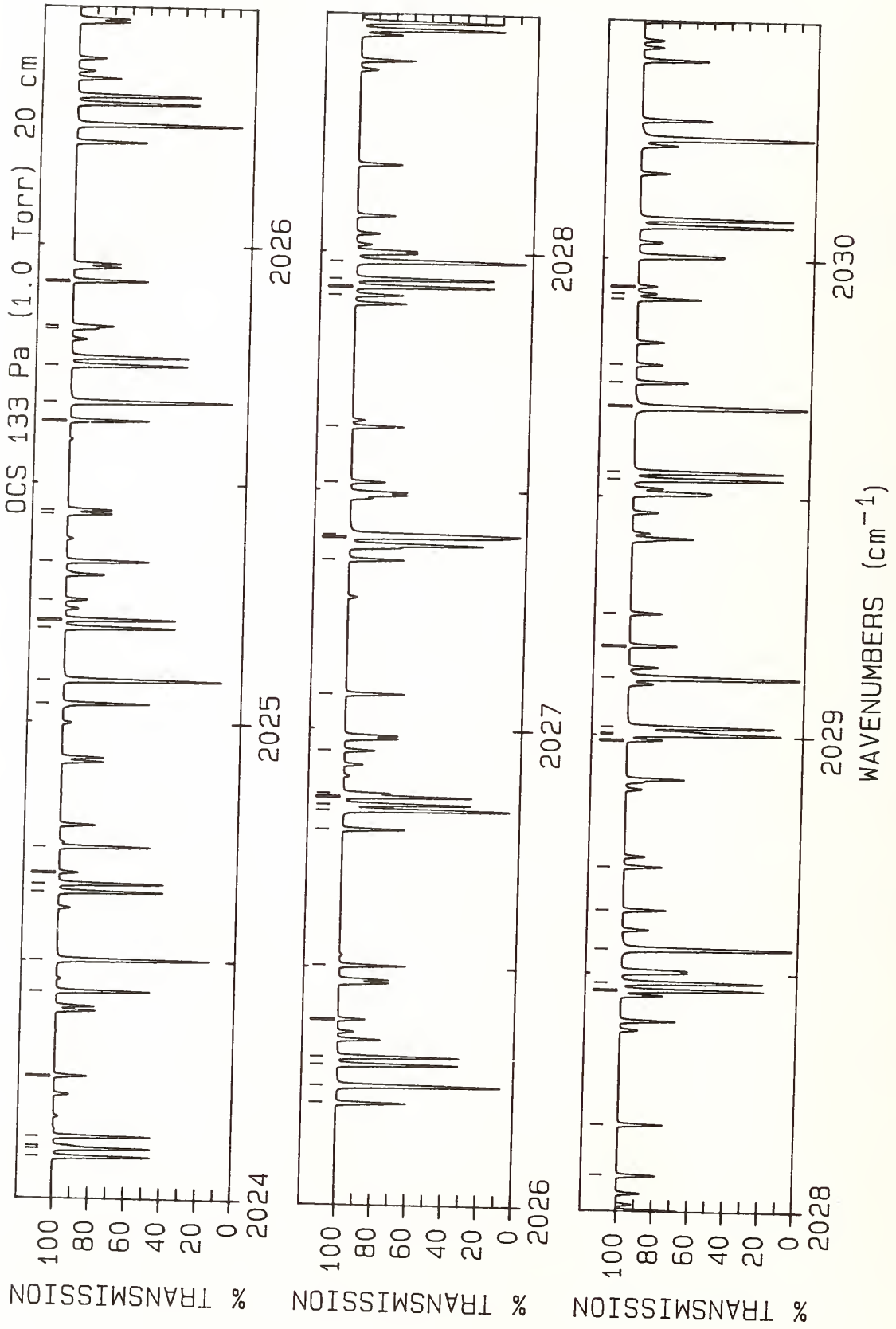

LINE #	WAVENUMBER(unc) (cm ⁻¹)	LOWER STATE (cm ⁻¹)	INTENSITY (cm/molecule)	ASSIGNMENT ROTATION BAND	LINE #	WAVENUMBER(unc) (cm ⁻¹)	LOWER STATE (cm ⁻¹)	INTENSITY (cm/molecule)	ASSIGNMENT ROTATION BAND
1	2024.088 30(11)*	1365.45	0.649E-20	P(64) C	36	2026.864 78(9)	1505.91	0.242E-20	P(47) G
2	2024.105 70(11)*	1364.57	0.652E-20	P(64) B	37	2026.954 30(15)*	1039.01	0.154E-20	P(72) P
3	2024.111 32(19)*	1187.08	0.802E-21	P(77) P	38	2027.072 36(15)*	535.94	0.327E-20	R(51) T
4	2024.131 14(15)*	348.07	0.658E-20	R(41) T	39	2027.353 47(15)*	556.95	0.301E-20	R(52) T
5	2024.258 48(10)	1607.56	0.163E-20	P(52) G	40	2027.401 25(10)*	1214.93	0.123E-19	P(58) B
6	2024.435 88(15)*	365.04	0.621E-20	R(42) T	41	2027.405 97(12)*	1035.87	0.358E-19	P(71) A
7	2024.501 53(12)*	1185.63	0.185E-19	P(76) A	42	2027.515 98(14)*	1010.57	0.175E-20	P(71) P
8	2024.643 64(11)*	1339.47	0.725E-20	P(63) C	43	2027.632 21(15)*	578.35	0.277E-20	R(53) T
9	2024.660 80(11)*	1338.62	0.728E-20	P(63) B	44	2027.908 57(15)*	600.16	0.253E-20	R(54) T
10	2024.684 52(18)*	1156.68	0.917E-21	P(76) P	45	2027.926 50(10)*	1192.10	0.135E-19	P(57) C
11	2024.738 27(15)*	382.42	0.584E-20	R(43) T	46	2027.942 33(10)*	1191.40	0.135E-19	P(57) B
12	2025.038 30(15)*	400.19	0.547E-20	R(44) T	47	2027.979 75(12)*	1007.13	0.405E-19	P(70) A
13	2025.087 15(12)*	1154.87	0.212E-19	P(75) A	48	2028.075 36(14)*	982.53	0.197E-20	P(70) P
14	2025.196 63(11)*	1313.90	0.809E-20	P(62) C	49	2028.182 56(15)*	622.38	0.232E-20	R(55) T
15	2025.213 56(10)*	1313.07	0.812E-20	P(62) B	50	2028.465 44(10)*	1168.96	0.148E-19	P(56) C
16	2025.255 41(17)*	1126.67	0.105E-20	P(75) P	51	2028.481 06(10)*	1168.28	0.148E-19	P(56) B
17	2025.335 97(15)*	418.38	0.512E-20	R(45) T	52	2028.551 17(12)*	978.78	0.459E-19	P(69) A
18	2025.435 91(13)	1519.82	0.230E-20	P(48) F	53	2028.632 43(14)*	954.88	0.223E-20	P(69) P
19	2025.443 86(14)	1519.78	0.230E-20	P(48) E	54	2028.723 41(15)*	668.01	0.192E-20	R(57) T
20	2025.631 28(15)*	436.96	0.478E-20	R(46) T	55	2028.990 27(15)*	691.43	0.175E-20	R(58) T
21	2025.670 41(12)*	1124.52	0.242E-19	P(74) A	56	2029.002 04(10)*	1146.22	0.162E-19	P(55) C
22	2025.747 29(10)*	1288.73	0.899E-20	P(61) C	57	2029.004 25(11)	1391.69	0.367E-20	P(41) F
23	2025.824 01(16)*	1097.06	0.119E-20	P(74) P	58	2029.017 45(10)*	1145.56	0.163E-19	P(55) B
24	2025.829 29(9)	1545.35	0.208E-20	P(49) G	59	2029.120 21(12)*	950.85	0.518E-19	P(68) A
25	2025.924 23(15)*	455.95	0.446E-20	R(47) T	60	2029.187 20(14)*	927.63	0.251E-20	P(68) P
26	2026.214 81(15)*	475.34	0.414E-20	R(48) T	61	2029.254 75(15)*	715.26	0.158E-20	R(59) T
27	2026.251 29(12)*	1094.57	0.276E-19	P(73) A	62	2029.536 29(10)*	1123.88	0.178E-19	P(54) C
28	2026.295 60(10)*	1263.97	0.998E-20	P(60) C	63	2029.551 49(10)*	1123.25	0.178E-19	P(54) B
29	2026.312 09(10)*	1263.19	0.100E-19	P(60) B	64	2029.686 88(12)*	923.31	0.584E-19	P(67) A
30	2026.390 30(15)*	1067.84	0.136E-20	P(73) P	65	2029.690 10(27)	1648.29	0.159E-20	P(62) D
31	2026.503 03(15)*	495.14	0.384E-20	R(49) T	66	2029.739 65(14)*	900.76	0.281E-20	P(67) P
32	2026.788 88(15)*	515.34	0.355E-20	R(50) T	67	2029.776 57(15)*	764.12	0.129E-20	R(61) T
33	2026.829 82(12)*	1065.02	0.315E-19	P(72) A	68	2029.915 08(8)	1397.33	0.358E-20	P(41) G
34	2026.841 58(10)*	1239.61	0.110E-19	P(59) C	69	2029.926 19(7)	1086.97	0.901E-21	P(53) R
35	2026.857 84(10)*	1238.86	0.111E-19	P(59) B	70	2029.941 20(6)	1086.39	0.904E-21	P(53) Q

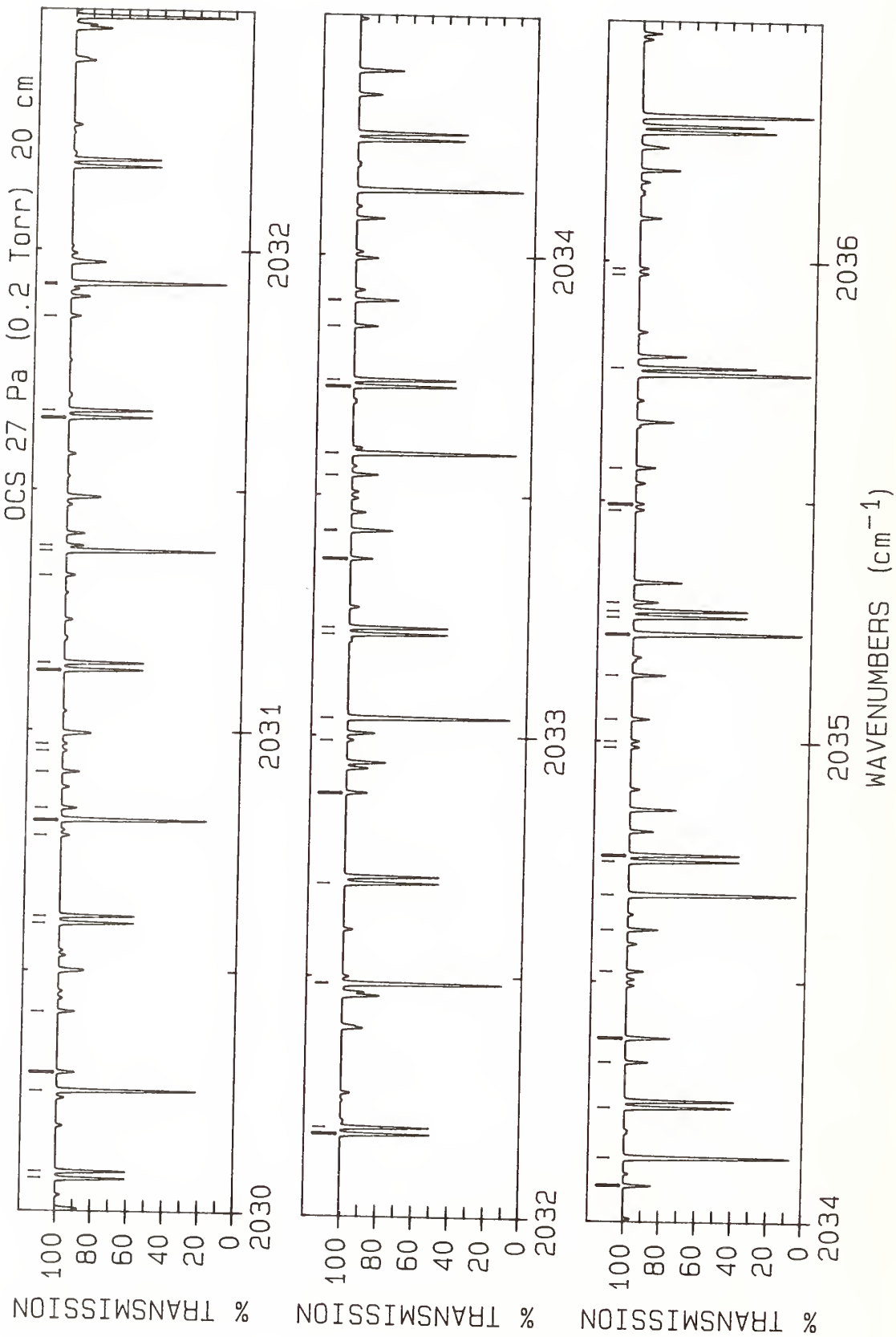

LINE #	WAVENUMBER(unc) (cm ⁻¹)	LOWER STATE (cm ⁻¹)	INTENSITY (cm/molecule)	ASSIGNMENT ROTATION BAND	LINE #	WAVENUMBER(unc) (cm ⁻¹)	LOWER STATE (cm ⁻¹)	INTENSITY (cm/molecule)	ASSIGNMENT ROTATION BAND
1	2030.068 20(10)*	1101.95	0.194E-19	P(53) C	36	2033.425 21(10)	1256.20	0.554E-20	P(32) F
2	2030.083 20(10)*	1101.34	0.195E-19	P(53) B	37	2033.427 02(10)	1256.19	0.554E-20	P(32) E
3	2030.251 17(12)*	896.18	0.656E-19	P(66) A	38	2033.542 02(14)*	723.75	0.597E-20	P(60) P
4	2030.288 86(16)*	814.58	0.104E-20	R(63) T	39	2033.587 02(12)*	741.87	0.127E-18	P(60) A
5	2030.289 79(14)*	874.29	0.315E-20	P(66) P	40	2033.725 81(10)*	959.78	0.337E-19	P(46) C
6	2030.415 29(8)	1380.65	0.379E-20	P(40) G	41	2033.739 37(10)*	959.33	0.338E-19	P(46) B
7	2030.597 76(10)*	1080.42	0.212E-19	P(52) C	42	2033.851 37(7)	1275.30	0.522E-20	P(33) G
8	2030.612 55(10)*	1079.84	0.212E-19	P(52) B	43	2033.904 82(10)	1243.18	0.571E-20	P(31) F
9	2030.780 13(26)	1598.62	0.196E-20	P(60) D	44	2033.906 43(10)	1243.17	0.571E-20	P(31) E
10	2030.813 09(12)*	869.46	0.736E-19	P(65) A	45	2034.075 94(14)*	700.04	0.658E-20	P(59) P
11	2030.837 62(14)*	848.22	0.352E-20	P(65) P	46	2034.134 67(12)*	717.57	0.140E-18	P(59) A
12	2030.913 15(8)	1364.38	0.400E-20	P(39) G	47	2034.238 92(10)*	941.10	0.361E-19	P(45) C
13	2030.956 75(6)	1045.37	0.106E-20	P(51) R	48	2034.332 91(7)	1261.88	0.541E-20	P(32) G
14	2030.971 29(5)	1044.83	0.107E-20	P(51) Q	49	2034.382 10(10)	1230.57	0.588E-20	P(30) F
15	2031.124 97(10)*	1059.31	0.230E-19	P(51) C	50	2034.383 54(10)	1230.56	0.588E-20	P(30) E
16	2031.139 56(10)*	1058.74	0.231E-19	P(51) B	51	2034.521 18(25)	1437.45	0.379E-20	P(53) D
17	2031.321 62(26)	1574.38	0.217E-20	P(59) D	52	2034.607 55(14)*	676.72	0.725E-20	P(58) P
18	2031.372 64(12)*	843.13	0.824E-19	P(64) A	53	2034.679 93(12)*	693.67	0.155E-18	P(58) A
19	2031.383 13(14)*	822.54	0.393E-20	P(64) P	54	2034.749 69(10)*	922.82	0.386E-19	P(44) C
20	2031.649 84(10)*	1038.59	0.249E-19	P(50) C	55	2034.762 84(10)*	922.39	0.387E-19	P(44) B
21	2031.664 22(10)*	1038.05	0.250E-19	P(50) B	56	2034.987 43(4)	894.77	0.187E-20	P(43) R
22	2031.860 75(26)	1550.55	0.239E-20	P(58) D	57	2035.000 13(4)	894.39	0.187E-20	P(43) Q
23	2031.926 33(14)*	797.25	0.438E-20	P(63) P	58	2035.046 21(25)	1416.04	0.413E-20	P(52) D
24	2031.929 80(12)*	817.21	0.920E-19	P(63) A	59	2035.136 83(14)*	653.80	0.797E-20	P(57) P
25	2032.172 35(10)*	1018.28	0.270E-19	P(49) C	60	2035.222 81(12)*	670.17	0.171E-18	P(57) A
26	2032.186 53(10)*	1017.76	0.271E-19	P(49) B	61	2035.258 10(10)*	904.94	0.411E-19	P(43) C
27	2032.484 59(12)*	791.70	0.103E-18	P(62) A	62	2035.271 04(10)*	904.54	0.412E-19	P(43) B
28	2032.485 43(5)	985.93	0.134E-20	P(48) R	63	2035.289 00(7)	1236.25	0.575E-20	P(30) G
29	2032.692 52(10)*	998.38	0.291E-19	P(48) C	64	2035.480 95(4)	877.73	0.198E-20	P(42) R
30	2032.881 29(7)	1303.37	0.483E-20	P(35) G	65	2035.493 42(3)	877.36	0.198E-20	P(42) Q
31	2032.990 41(5)	966.90	0.143E-20	P(47) R	66	2035.568 88(25)	1395.03	0.449E-20	P(51) D
32	2033.037 00(12)*	766.58	0.114E-18	P(61) A	67	2035.776 89(10)*	887.08	0.438E-19	P(42) B
33	2033.210 34(10)*	978.88	0.313E-19	P(47) C	68	2035.972 18(4)	861.08	0.210E-20	P(41) R
34	2033.224 11(10)*	978.40	0.314E-19	P(47) B	69	2035.984 43(3)	860.73	0.210E-20	P(41) Q
35	2033.367 50(7)	1289.13	0.503E-20	P(34) G					

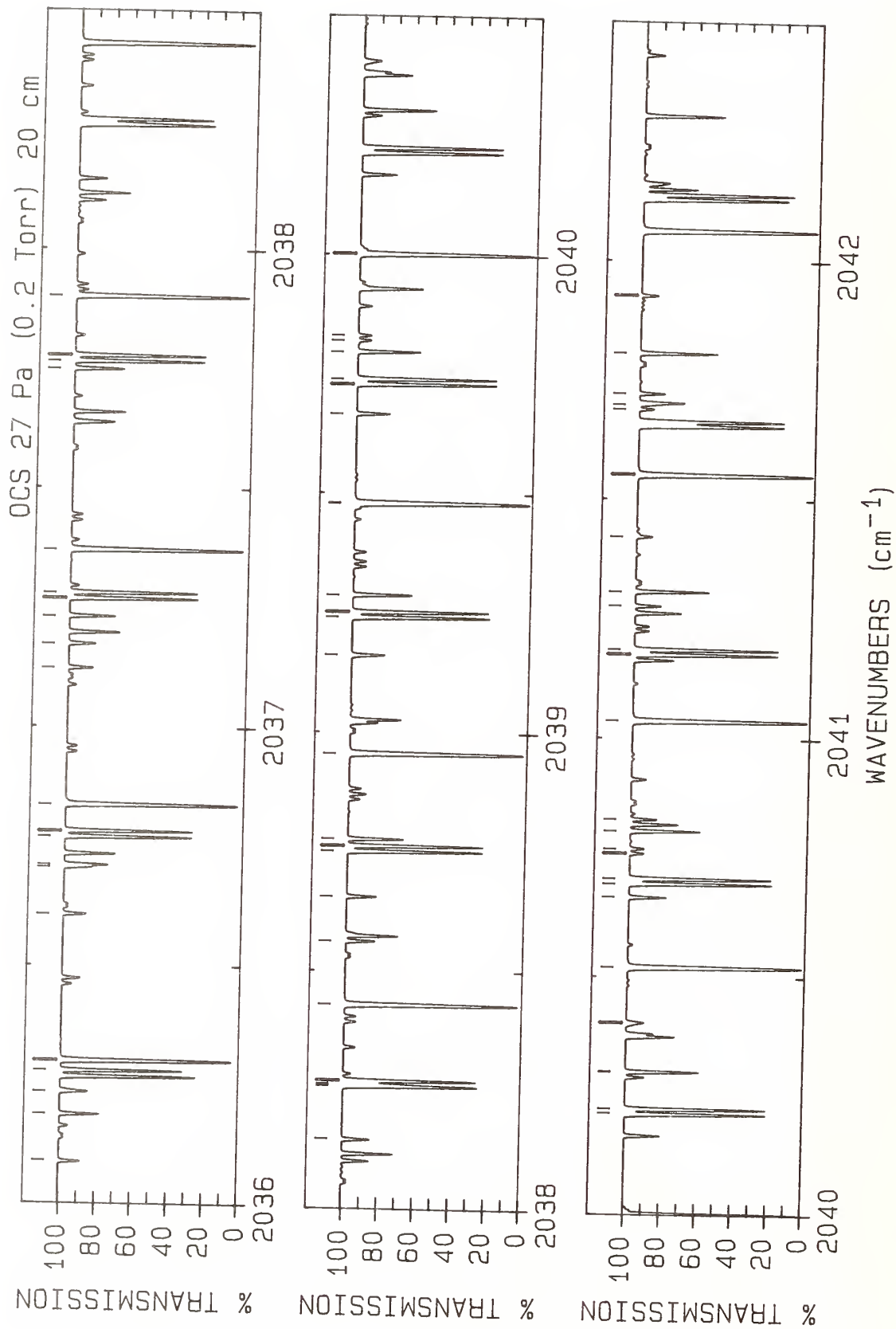

LINE #	WAVENUMBER(unc) (cm ⁻¹)	LOWER STATE (cm ⁻¹)	INTENSITY (cm/molecule)	ASSIGNMENT ROTATION BAND	LINE #	WAVENUMBER(unc) (cm ⁻¹)	LOWER STATE (cm ⁻¹)	INTENSITY (cm/molecule)	ASSIGNMENT ROTATION BAND	LINE #	WAVENUMBER(unc) (cm ⁻¹)	LOWER STATE (cm ⁻¹)	INTENSITY (cm/molecule)	ASSIGNMENT ROTATION BAND
1	2036.089 21(25)	1374.42	0.486E-20	P(50)	D	36	2039.287 41(14)*	484.60	P(49)	P(49)	36	2039.287 41(14)*	0.156E-19	P(49)
2	2036.188 43(14)*	609.13	0.956E-20	P(55)	P	37	2039.478 80(10)	1118.64	P(55)	P(19)	37	2039.478 80(10)	0.639E-20	P(19)
3	2036.235 78(7)	1212.24	0.603E-20	P(28)	G	38	2039.479 91(12)*	496.74	P(28)	P(49)	38	2039.479 91(12)*	0.341E-18	P(49)
4	2036.280 38(10)*	870.04	0.465E-19	P(41)	B	39	2039.665 73(25)	1241.47	P(41)	D	39	2039.665 73(25)	0.800E-20	D
5	2036.301 41(12)*	624.39	0.206E-18	P(55)	A	40	2039.727 86(10)*	762.31	P(55)	C	40	2039.727 86(10)*	0.652E-19	C
6	2036.607 19(25)	1354.22	0.526E-20	P(49)	D	41	2039.738 81(10)*	762.05	P(49)	B	41	2039.738 81(10)*	0.652E-19	B
7	2036.705 68(7)	1200.85	0.615E-20	P(27)	G	42	2039.795 76(14)*	465.23	P(27)	P	42	2039.795 76(14)*	0.168E-19	P
8	2036.710 74(14)*	587.39	0.104E-19	P(54)	P	43	2039.819 40(4)	742.14	P(54)	R	43	2039.819 40(4)	0.301E-20	R
9	2036.769 22(10)*	853.74	0.491E-19	P(40)	C	44	2039.829 79(3)	741.92	P(40)	Q	44	2039.829 79(3)	0.302E-20	Q
10	2036.781 52(10)*	853.39	0.492E-19	P(40)	B	45	2040.001 30(12)*	476.88	P(40)	A	45	2040.001 30(12)*	0.368E-18	A
11	2036.837 13(12)*	602.10	0.225E-18	P(54)	A	46	2040.212 71(10)*	748.49	P(54)	C	46	2040.212 71(10)*	0.677E-19	C
12	2037.122 81(25)	1334.42	0.567E-20	P(48)	D	47	2040.223 43(10)*	748.25	P(48)	B	47	2040.223 43(10)*	0.677E-19	B
13	2037.173 24(7)	1189.87	0.625E-20	P(26)	G	48	2040.300 11(3)	728.85	P(26)	Q	48	2040.300 11(3)	0.312E-20	Q
14	2037.230 73(14)*	566.04	0.114E-19	P(53)	P	49	2040.301 78(14)*	446.25	P(53)	P	49	2040.301 78(14)*	0.181E-19	P
15	2037.268 21(10)*	837.49	0.518E-19	P(39)	C	50	2040.403 87(7)	451.67	P(39)	L	50	2040.403 87(7)	0.317E-20	L
16	2037.280 30(10)*	837.16	0.519E-19	P(39)	B	51	2040.520 29(12)*	457.42	P(39)	A	51	2040.520 29(12)*	0.396E-18	A
17	2037.370 47(12)*	580.22	0.246E-18	P(53)	A	52	2040.666 48(25)	1207.11	P(53)	D	52	2040.666 48(25)	0.901E-20	D
18	2037.748 39(14)*	545.09	0.124E-19	P(52)	P	53	2040.695 21(10)*	735.07	P(52)	C	53	2040.695 21(10)*	0.701E-19	C
19	2037.764 85(10)*	821.64	0.546E-19	P(38)	C	54	2040.705 69(10)*	734.85	P(38)	B	54	2040.705 69(10)*	0.701E-19	B
20	2037.776 72(10)*	821.33	0.546E-19	P(38)	B	55	2040.758 24(4)	716.37	P(38)	R	55	2040.758 24(4)	0.321E-20	R
21	2037.901 41(12)*	558.74	0.268E-18	P(52)	A	56	2040.768 14(3)	716.17	P(52)	Q	56	2040.768 14(3)	0.321E-20	Q
22	2038.147 02(25)	1296.03	0.656E-20	P(46)	D	57	2040.805 47(14)*	427.66	P(46)	P	57	2040.805 47(14)*	0.194E-19	P
23	2038.259 14(10)*	806.20	0.573E-19	P(37)	C	58	2040.829 95(8)	1116.63	P(37)	G	58	2040.829 95(8)	0.618E-20	G
24	2038.263 72(14)*	524.53	0.134E-19	P(51)	P	59	2041.036 89(12)*	438.37	P(51)	A	59	2041.036 89(12)*	0.426E-18	A
25	2038.270 78(10)*	805.90	0.574E-19	P(37)	B	60	2041.175 35(10)*	722.07	P(37)	C	60	2041.175 35(10)*	0.723E-19	C
26	2038.429 97(12)*	537.67	0.291E-18	P(51)	A	61	2041.185 59(10)*	721.86	P(51)	B	61	2041.185 59(10)*	0.724E-19	B
27	2038.561 97(7)	1159.35	0.641E-20	P(23)	G	62	2041.276 57(8)	1109.30	P(23)	G	62	2041.276 57(8)	0.605E-20	G
28	2038.655 60(25)	1277.44	0.702E-20	P(45)	D	63	2041.306 83(14)*	409.47	P(45)	P	63	2041.306 83(14)*	0.207E-19	P
29	2038.751 07(10)*	791.16	0.600E-19	P(36)	C	64	2041.421 41(6)	414.44	P(36)	L	64	2041.421 41(6)	0.364E-20	L
30	2038.762 49(10)*	790.88	0.600E-19	P(36)	B	65	2041.551 09(12)*	419.73	P(36)	A	65	2041.551 09(12)*	0.456E-18	A
31	2038.776 73(14)*	504.37	0.145E-19	P(50)	P	66	2041.687 88(4)	692.18	P(50)	R	66	2041.687 88(4)	0.338E-20	R
32	2038.956 14(12)*	517.00	0.315E-18	P(50)	A	67	2041.697 28(3)	692.01	P(50)	Q	67	2041.697 28(3)	0.338E-20	Q
33	2039.161 84(25)	1259.25	0.750E-20	P(44)	D	68	2041.720 85(8)	1102.39	P(44)	G	68	2041.720 85(8)	0.589E-20	G
34	2039.240 64(10)*	776.53	0.626E-19	P(35)	C	69	2041.805 86(14)*	391.68	P(35)	P	69	2041.805 86(14)*	0.221E-19	P
35	2039.251 83(10)*	776.26	0.627E-19	P(35)	B	70	2041.926 64(6)	396.43	P(35)	L	70	2041.926 64(6)	0.389E-20	L

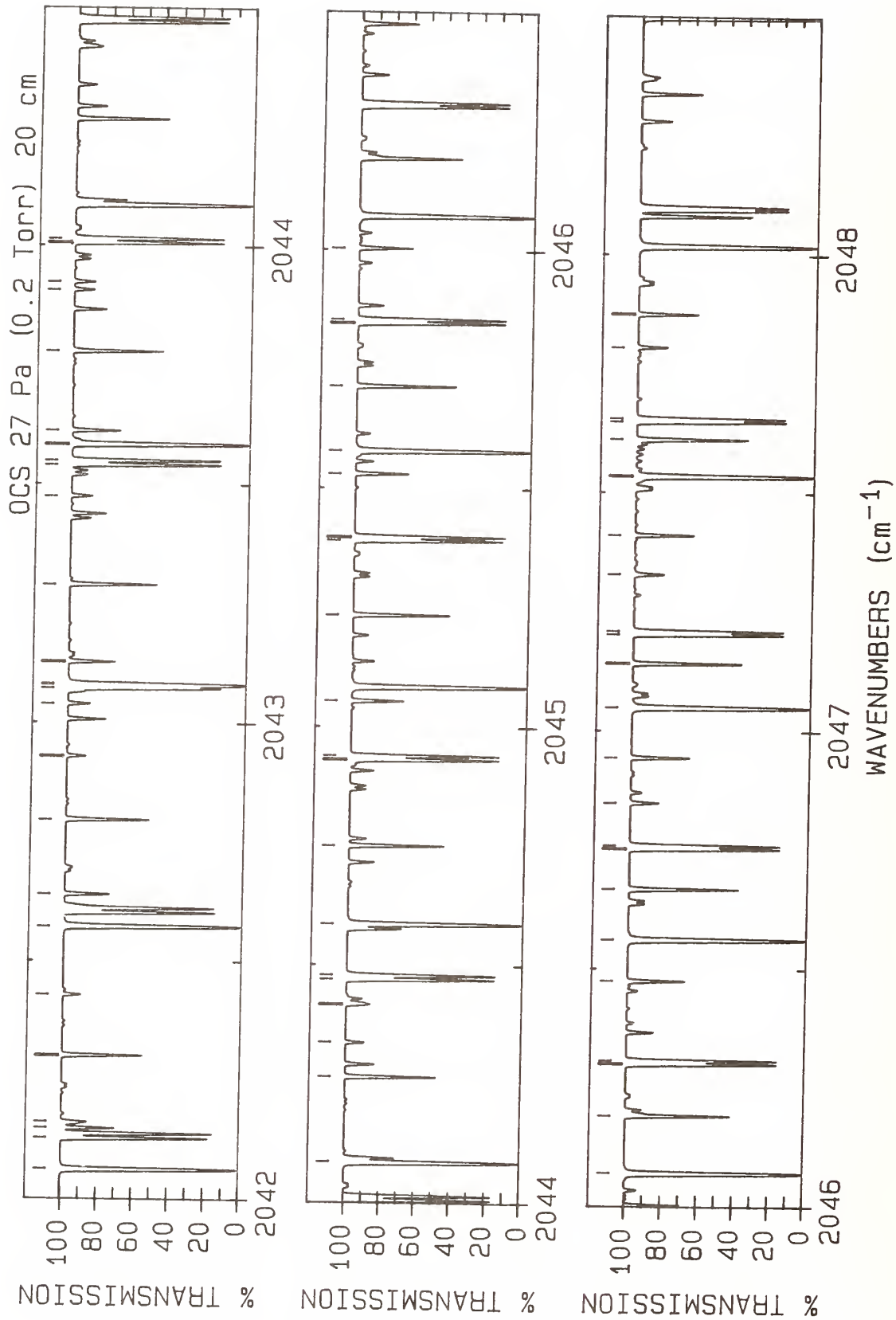

LINE #	WAVENUMBER(unc) (cm ⁻¹)	LOWER STATE (cm ⁻¹)	INTENSITY (cm/molecule)	ASSIGNMENT ROTATION BAND	LINE #	WAVENUMBER(unc) (cm ⁻¹)	LOWER STATE (cm ⁻¹)	INTENSITY (cm/molecule)	ASSIGNMENT ROTATION BAND
1	2042.062 90(13)*	401.49	0.487E-18	P(44) A	36	2044.939 57(10)*	632.52	0.830E-19	P(23) B
2	2042.128 55(10)*	697.27	0.763E-19	P(29) C	37	2045.054 20(25)	1072.49	0.136E-19	P(32) D
3	2042.150 06(25)	1158.61	0.106E-19	P(38) D	38	2045.233 72(14)*	278.16	0.323E-19	P(37) P
4	2042.162 80(8)	1095.88	0.570E-20	P(15) G	39	2045.390 32(10)*	623.29	0.830E-19	P(22) C
5	2042.302 56(14)*	374.27	0.235E-19	P(43) P	40	2045.397 06(6)	281.54	0.572E-20	P(37) L
6	2042.429 51(6)	378.82	0.414E-20	P(43) L	41	2045.398 15(10)*	623.18	0.831E-19	P(22) B
7	2042.572 32(13)*	383.65	0.520E-18	P(43) A	42	2045.530 07(25)	1059.56	0.140E-19	P(31) D
8	2042.639 91(25)	1143.24	0.111E-19	P(37) D	43	2045.578 46(13)*	285.13	0.723E-18	P(37) A
9	2042.796 92(14)*	357.27	0.249E-19	P(42) P	44	2045.714 07(14)*	263.53	0.337E-19	P(36) P
10	2042.930 01(6)	361.61	0.440E-20	P(42) L	45	2045.846 82(10)*	614.35	0.828E-19	P(21) C
11	2043.039 72(8)	1084.07	0.524E-20	P(13) G	46	2045.854 37(10)*	614.25	0.828E-19	P(21) B
12	2043.072 30(10)*	674.10	0.796E-19	P(27) C	47	2046.003 63(25)	1047.02	0.144E-19	P(30) D
13	2043.079 34(13)*	366.22	0.553E-18	P(42) A	48	2046.071 09(13)*	270.13	0.757E-18	P(36) A
14	2043.081 52(10)*	673.94	0.796E-19	P(27) B	49	2046.192 09(14)*	249.29	0.351E-19	P(35) P
15	2043.127 43(25)	1128.29	0.116E-19	P(36) D	50	2046.300 97(10)*	605.81	0.822E-19	P(20) C
16	2043.288 95(14)*	340.66	0.264E-19	P(41) P	51	2046.308 21(10)*	605.72	0.822E-19	P(20) B
17	2043.474 69(8)	1078.78	0.496E-20	P(12) G	52	2046.474 86(25)	1034.89	0.148E-19	P(29) D
18	2043.540 63(10)*	663.13	0.808E-19	P(26) C	53	2046.561 31(13)*	255.53	0.790E-18	P(35) A
19	2043.549 58(10)*	662.98	0.809E-19	P(26) B	54	2046.667 77(14)*	235.44	0.365E-19	P(34) P
20	2043.583 96(13)*	349.19	0.586E-18	P(41) A	55	2046.752 74(10)*	597.68	0.812E-19	P(19) C
21	2043.612 61(25)	1113.73	0.121E-19	P(35) D	56	2046.759 69(10)*	597.60	0.812E-19	P(19) B
22	2043.778 65(14)*	324.44	0.278E-19	P(40) P	57	2046.848 89(6)	238.30	0.649E-20	P(34) L
23	2043.907 32(8)	1073.90	0.466E-20	P(11) G	58	2046.943 77(25)	1023.17	0.151E-19	P(28) D
24	2043.923 93(6)	328.38	0.492E-20	P(40) L	59	2047.049 14(13)*	241.34	0.822E-18	P(34) A
25	2044.006 60(10)*	652.56	0.818E-19	P(25) C	60	2047.141 11(14)*	221.99	0.379E-19	P(33) P
26	2044.015 28(10)*	652.42	0.819E-19	P(25) B	61	2047.202 15(10)*	589.95	0.799E-19	P(18) C
27	2044.086 18(13)*	332.57	0.620E-18	P(40) A	62	2047.208 78(10)*	589.88	0.799E-19	P(18) B
28	2044.266 01(14)*	308.62	0.293E-19	P(39) P	63	2047.328 09(6)	224.69	0.673E-20	P(33) L
29	2044.337 63(8)	1069.42	0.433E-20	P(10) G	64	2047.410 37(25)	1011.84	0.154E-19	P(27) D
30	2044.417 34(6)	312.37	0.519E-20	P(39) L	65	2047.534 56(13)*	227.55	0.854E-18	P(33) A
31	2044.470 20(10)*	642.40	0.825E-19	P(24) C	66	2047.612 11(14)*	208.93	0.391E-19	P(32) P
32	2044.478 61(10)*	642.27	0.826E-19	P(24) B	67	2047.649 18(10)*	582.63	0.781E-19	P(17) C
33	2044.586 01(13)*	316.35	0.654E-18	P(39) A	68	2047.655 50(10)*	582.57	0.782E-19	P(17) B
34	2044.751 03(14)*	293.19	0.308E-19	P(38) P	69	2047.804 92(6)	211.47	0.697E-20	P(32) L
35	2044.931 44(10)*	632.64	0.829E-19	P(23) C	70	2047.874 65(25)	1000.93	0.156E-19	P(26) D

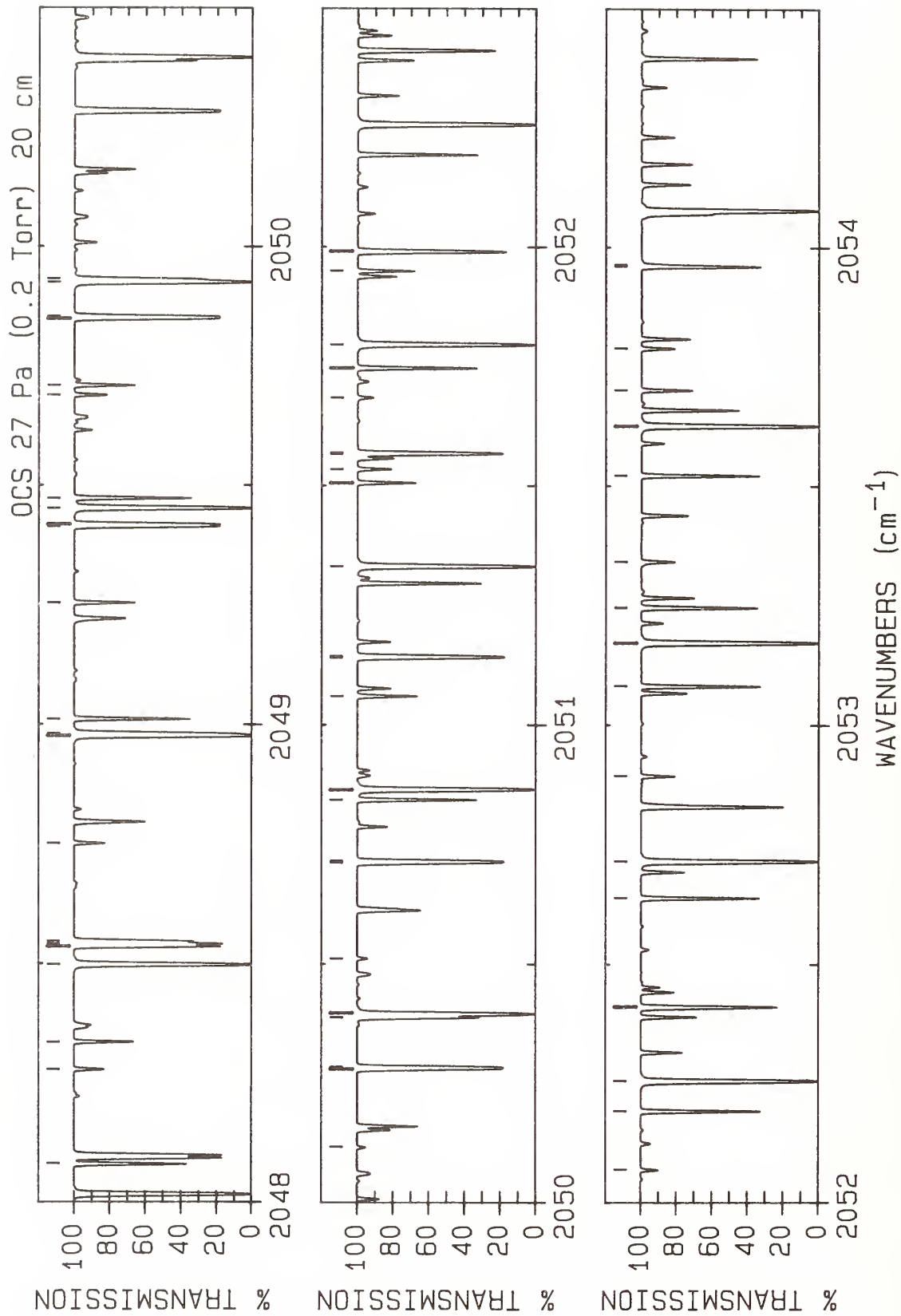

LINE #	WAVENUMBER(unc) (cm ⁻¹)	LOWER STATE (cm ⁻¹)	INTENSITY (cm/molecule)	ASSIGNMENT ROTATION BAND	LINE #	WAVENUMBER(unc) (cm ⁻¹)	LOWER STATE (cm ⁻¹)	INTENSITY (cm/molecule)	ASSIGNMENT ROTATION BAND
1	2048.080 77(14)*	196.27	0.403E-19	P(31) P	36	2051.059 95(25)	935.82	0.157E-19	P(19) D
2	2048.279 39(6)	198.66	0.718E-20	P(31) L	37	2051.140 10(11)*	538.72	0.508E-19	P(9) C
3	2048.336 62(25)	990.41	0.158E-19	P(25) D	38	2051.143 68(11)*	538.70	0.509E-19	P(9) B
4	2048.498 19(13)*	201.19	0.912E-18	P(31) A	39	2051.331 35(13)*	131.84	0.103E-17	P(25) A
5	2048.536 15(10)*	569.22	0.735E-19	P(15) C	40	2051.505 77(25)	928.13	0.154E-19	P(18) D
6	2048.541 82(10)*	569.16	0.736E-19	P(15) B	41	2051.534 19(5)	120.17	0.816E-20	P(24) L
7	2048.547 09(14)*	184.01	0.414E-19	P(30) P	42	2051.565 78(11)*	535.06	0.459E-19	P(8) C
8	2048.751 48(6)	186.25	0.739E-20	P(30) L	43	2051.568 99(11)*	535.04	0.459E-19	P(8) B
9	2048.976 07(11)*	563.12	0.707E-19	P(14) C	44	2051.683 75(8)	1058.44	0.367E-20	R(7) G
10	2048.976 40(13)*	188.62	0.938E-18	P(30) A	45	2051.745 77(14)*	109.23	0.458E-19	P(23) P
11	2048.981 41(11)*	563.07	0.707E-19	P(14) B	46	2051.795 12(13)*	121.70	0.104E-17	P(24) A
12	2049.011 07(14)*	172.14	0.424E-19	P(29) P	47	2051.949 29(25)	920.85	0.151E-19	P(17) D
13	2049.253 62(25)	970.60	0.160E-19	P(23) D	48	2051.989 08(11)*	531.81	0.406E-19	P(7) C
14	2049.413 63(11)*	557.42	0.674E-19	P(13) C	49	2051.989 66(5)	110.55	0.819E-20	P(23) L
15	2049.418 63(11)*	557.38	0.675E-19	P(13) B	50	2051.991 91(11)*	531.80	0.406E-19	P(7) B
16	2049.452 20(13)*	176.45	0.963E-18	P(29) A	51	2052.069 63(8)	1061.69	0.406E-20	R(8) G
17	2049.472 71(14)*	160.67	0.433E-19	P(28) P	52	2052.193 35(14)*	100.13	0.458E-19	P(22) P
18	2049.688 54(6)	162.62	0.773E-20	P(28) L	53	2052.256 48(13)*	111.96	0.105E-17	P(23) A
19	2049.708 66(25)	961.29	0.161E-19	P(22) D	54	2052.410 00(11)*	528.96	0.350E-19	P(6) C
20	2049.848 81(11)*	552.14	0.638E-19	P(12) C	55	2052.412 45(11)*	528.95	0.350E-19	P(6) B
21	2049.853 46(11)*	552.11	0.638E-19	P(12) B	56	2052.638 58(14)*	91.42	0.456E-19	P(21) P
22	2049.925 60(13)*	164.69	0.984E-18	P(28) A	57	2052.715 42(13)*	102.63	0.105E-17	P(22) A
23	2049.932 01(14)*	149.59	0.441E-19	P(27) P	58	2052.893 48(5)	92.53	0.817E-20	P(21) L
24	2050.116 78(9)	1049.48	0.191E-20	R(3) G	59	2053.081 47(14)*	83.11	0.452E-19	P(20) P
25	2050.281 61(11)*	547.26	0.598E-19	P(11) C	60	2053.171 96(13)*	93.71	0.104E-17	P(21) A
26	2050.285 91(11)*	547.23	0.598E-19	P(11) B	61	2053.244 71(11)*	524.49	0.230E-19	P(4) C
27	2050.388 97(14)*	138.90	0.447E-19	P(26) P	62	2053.246 37(11)*	524.48	0.230E-19	P(4) B
28	2050.396 59(13)*	153.34	0.100E-17	P(27) A	63	2053.341 82(5)	84.12	0.811E-20	P(20) L
29	2050.398 96(12)	1049.84	0.307E-20	R(6) E	64	2053.522 01(14)*	75.19	0.446E-19	P(19) P
30	2050.398 97(12)	1049.84	0.307E-20	R(6) F	65	2053.626 08(13)*	85.19	0.104E-17	P(20) A
31	2050.512 04(9)	1051.11	0.237E-20	R(4) G	66	2053.700 40(26)	895.77	0.131E-19	P(13) D
32	2050.712 04(11)*	542.79	0.555E-19	P(10) C	67	2053.787 78(5)	76.11	0.801E-20	P(19) L
33	2050.715 99(11)*	542.76	0.555E-19	P(10) B	68	2053.960 20(14)*	67.68	0.439E-19	P(18) P
34	2050.843 58(14)*	128.62	0.452E-19	P(25) P	69	2053.963 78(8)	1084.07	0.567E-20	R(13) G
35	2050.865 18(13)*	142.38	0.102E-17	P(26) A					

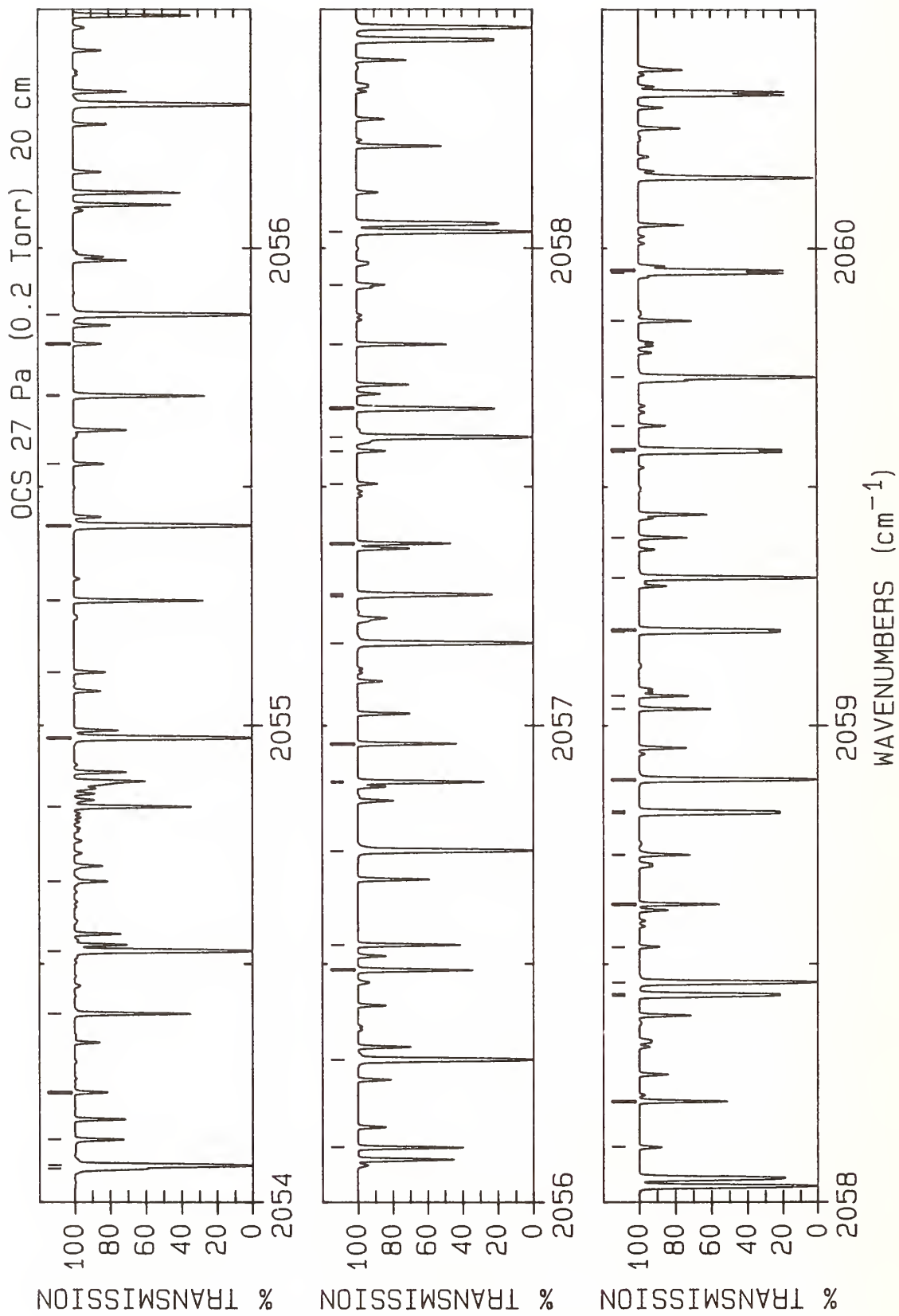

LINE #	WAVENUMBER(unc) (cm ⁻¹)	LOWER STATE (cm ⁻¹)	INTENSITY (cm/molecule)	ASSIGNMENT ROTATION BAND	LINE #	WAVENUMBER(unc) (cm ⁻¹)	LOWER STATE (cm ⁻¹)	INTENSITY (cm/molecule)	ASSIGNMENT ROTATION BAND
1	2054.069 89(11)*	521.64	0.934E-20	P(2) C	36	2057.506 14(26)	863.01	0.472E-20	P(4) D
2	2054.070 73(11)*	521.64	0.934E-20	P(2) B	37	2057.575 26(7)	1159.35	0.675E-20	R(23) G
3	2054.077 79(13)*	77.08	0.102E-17	P(19) A	38	2057.604 54(13)*	26.78	0.759E-18	P(11) A
4	2054.132 44(26)	890.52	0.124E-19	P(12) D	39	2057.661 95(11)*	528.95	0.413E-19	R(6) B
5	2054.231 36(5)	68.50	0.787E-20	P(18) L	40	2057.665 11(11)*	528.96	0.413E-19	R(6) C
6	2054.396 04(14)*	60.55	0.429E-19	P(17) P	41	2057.798 15(14)*	17.81	0.280E-19	P(9) P
7	2054.527 09(13)*	69.37	0.101E-17	P(18) A	42	2057.923 40(7)	1169.12	0.671E-20	R(24) G
8	2054.672 56(5)	61.29	0.770E-20	P(17) L	43	2058.034 51(13)*	22.31	0.705E-18	P(10) A
9	2054.829 54(14)*	53.83	0.417E-19	P(16) P	44	2058.116 37(8)	18.03	0.504E-20	P(9) L
10	2054.973 98(13)*	62.07	0.986E-18	P(17) A	45	2058.212 82(14)*	14.25	0.253E-19	P(8) P
11	2055.111 38(6)	54.48	0.750E-20	P(16) L	46	2058.433 63(11)*	535.04	0.519E-19	R(8) B
12	2055.260 68(14)*	47.49	0.403E-19	P(15) P	47	2058.437 75(11)*	535.06	0.519E-19	R(8) C
13	2055.261 57(10)	1118.64	0.678E-20	R(19) E	48	2058.462 05(13)*	18.26	0.647E-18	P(9) A
14	2055.261 68(10)	1118.64	0.678E-20	R(19) F	49	2058.536 11(8)	14.42	0.456E-20	P(8) L
15	2055.418 45(13)*	55.17	0.960E-18	P(16) A	50	2058.625 14(14)*	11.08	0.225E-19	P(7) P
16	2055.547 81(6)	48.07	0.725E-20	P(15) L	51	2058.728 80(10)	1218.35	0.631E-20	R(29) E
17	2055.689 47(14)*	41.56	0.388E-19	P(14) P	52	2058.728 94(10)	1218.36	0.631E-20	R(29) F
18	2055.690 78(11)*	520.83	0.938E-20	R(1) B	53	2058.815 86(11)*	538.70	0.568E-19	R(9) B
19	2055.691 64(11)*	520.83	0.938E-20	R(1) C	54	2058.820 47(11)*	538.72	0.568E-19	R(9) C
20	2055.799 05(7)	1116.63	0.658E-20	R(18) G	55	2058.887 17(13)*	14.61	0.586E-18	P(8) A
21	2055.860 50(13)*	48.68	0.929E-18	P(15) A	56	2059.035 10(14)*	8.31	0.196E-19	P(6) P
22	2056.115 92(14)*	36.02	0.370E-19	P(13) P	57	2059.062 41(10)	1230.56	0.615E-20	R(30) E
23	2056.300 14(13)*	42.60	0.894E-18	P(14) A	58	2059.062 53(10)	1230.57	0.615E-20	R(30) F
24	2056.486 44(11)*	522.86	0.232E-19	R(3) B	59	2059.195 70(11)*	542.76	0.614E-19	R(10) B
25	2056.488 20(11)*	522.86	0.232E-19	R(3) C	60	2059.200 80(11)*	542.79	0.614E-19	R(10) C
26	2056.540 00(14)*	30.87	0.350E-19	P(12) P	61	2059.309 87(13)*	11.36	0.521E-18	P(7) A
27	2056.737 36(13)*	36.92	0.853E-18	P(13) A	62	2059.393 64(10)	1243.17	0.597E-20	R(31) E
28	2056.880 67(11)*	524.48	0.295E-19	R(4) B	63	2059.393 74(10)	1243.18	0.597E-20	R(31) F
29	2056.882 89(11)*	524.49	0.295E-19	R(4) C	64	2059.573 13(11)*	547.23	0.657E-19	R(11) B
30	2056.961 74(14)*	26.12	0.329E-19	P(11) P	65	2059.578 73(11)*	547.26	0.657E-19	R(11) C
31	2057.172 16(13)*	31.64	0.808E-18	P(12) A	66	2059.628 44(7)	1224.04	0.617E-20	R(29) G
32	2057.269 73(7)	26.44	0.591E-20	P(11) L	67	2059.730 14(13)*	8.52	0.453E-18	P(6) A
33	2057.272 51(11)*	526.51	0.355E-19	R(5) B	68	2059.847 94(14)*	3.96	0.133E-19	P(4) P
34	2057.275 20(11)*	526.52	0.355E-19	R(5) C	69	2059.948 15(11)*	552.11	0.696E-19	R(12) B
35	2057.381 12(14)*	21.77	0.305E-19	P(10) P	70	2059.954 26(11)*	552.14	0.695E-19	R(12) C

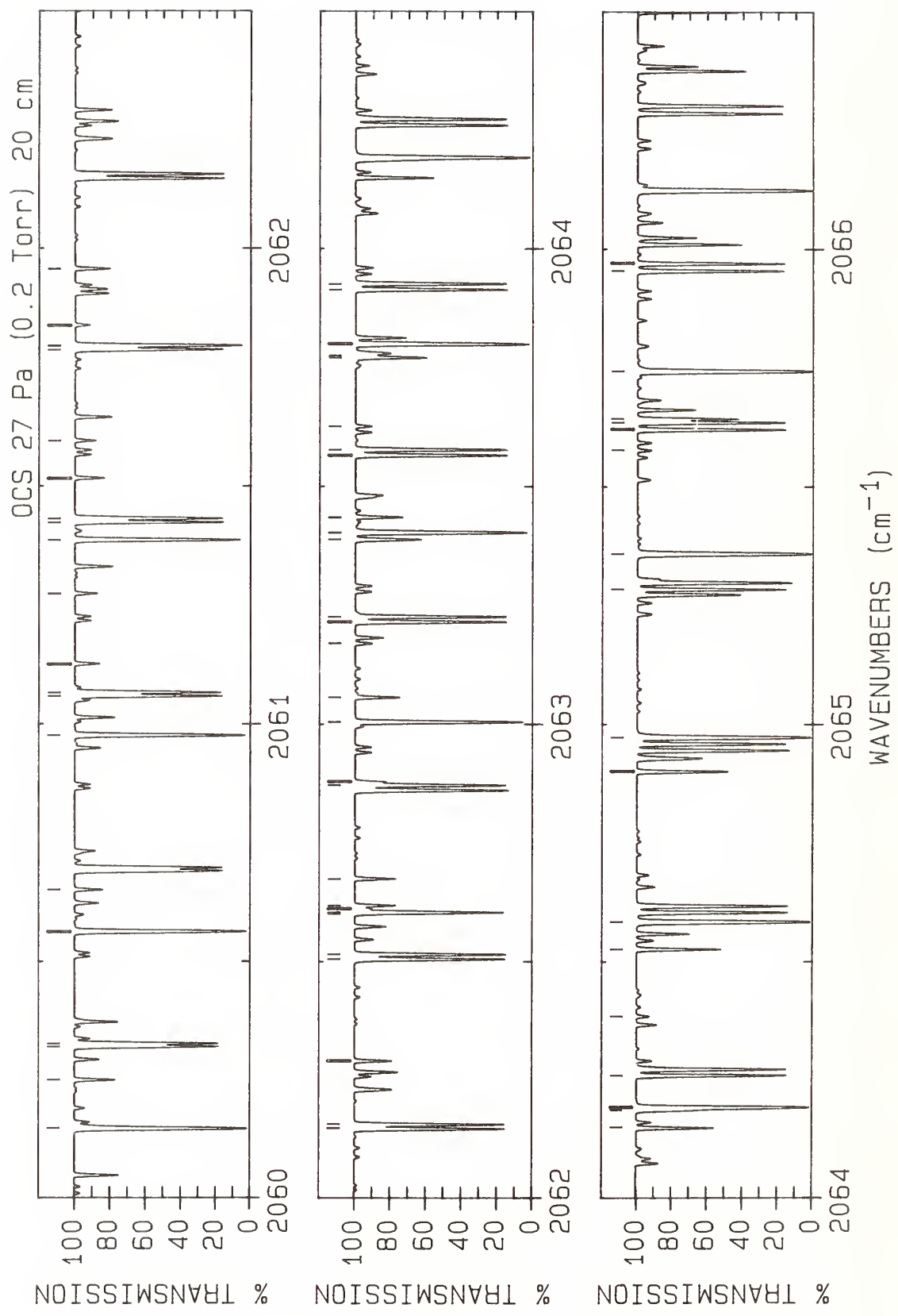

LINE #	WAVENUMBER(unc) (cm ⁻¹)	LOWER STATE (cm ⁻¹)	INTENSITY (cm/molecule)	ASSIGNMENT ROTATION BAND	LINE #	WAVENUMBER(unc) (cm ⁻¹)	LOWER STATE (cm ⁻¹)	INTENSITY (cm/molecule)	ASSIGNMENT ROTATION BAND
1	2060.147 99(13)*	6.09	0.382E-18	P(5) A	36	2063.004 83(14)*	2.38	0.134E-19	R(3) P
2	2060.250 82(14)*	2.38	0.101E-19	P(3) P	37	2063.004 98(13)*	0.41	0.157E-18	R(1) A
3	2060.320 76(10)*	557.38	0.731E-19	R(13) B	38	2063.056 34(26)	877.17	0.110E-19	R(9) D
4	2060.327 40(10)*	557.42	0.731E-19	R(13) C	39	2063.169 45(8)	1380.65	0.395E-20	R(40) G
5	2060.563 42(13)*	4.06	0.309E-18	P(4) A	40	2063.214 89(10)*	614.25	0.875E-19	R(21) B
6	2060.651 34(14)*	1.19	0.676E-20	P(2) P	41	2063.225 85(10)*	614.35	0.875E-19	R(21) C
7	2060.976 41(13)*	2.43	0.233E-18	P(3) A	42	2063.388 80(14)*	3.96	0.167E-19	R(4) P
8	2061.058 77(10)*	569.16	0.790E-19	R(15) B	43	2063.403 39(13)*	1.22	0.235E-18	R(2) A
9	2061.066 45(10)*	569.22	0.790E-19	R(15) C	44	2063.435 48(26)	881.21	0.119E-19	R(10) D
10	2061.125 96(26)	863.01	0.591E-20	R(4) D	45	2063.565 79(10)*	623.18	0.876E-19	R(22) B
11	2061.273 92(7)	1289.13	0.525E-20	R(34) G	46	2063.577 31(10)*	623.29	0.876E-19	R(22) C
12	2061.386 98(13)*	1.22	0.156E-18	P(2) A	47	2063.626 49(4)	648.56	0.378E-20	R(25) R
13	2061.424 16(10)*	575.66	0.814E-19	R(16) B	48	2063.770 40(14)*	5.94	0.198E-19	R(5) P
14	2061.432 37(10)*	575.72	0.814E-19	R(16) C	49	2063.775 02(8)	4.01	0.301E-20	R(4) L
15	2061.516 65(26)	865.03	0.703E-20	R(5) D	50	2063.799 38(13)*	2.43	0.311E-18	R(3) A
16	2061.595 84(7)	1303.37	0.504E-20	R(35) G	51	2063.914 27(10)*	632.52	0.874E-19	R(23) B
17	2061.787 13(10)*	582.57	0.834E-19	R(17) B	52	2063.926 36(10)*	632.64	0.873E-19	R(23) C
18	2061.795 13(13)*	0.41	0.786E-19	P(1) A	53	2064.149 62(14)*	8.31	0.229E-19	R(6) P
19	2061.795 88(10)*	582.63	0.833E-19	R(17) C	54	2064.186 79(26)	890.52	0.135E-19	R(12) D
20	2061.838 73(14)*	0.00	0.340E-20	R(0) P	55	2064.192 93(13)*	4.06	0.386E-18	R(4) A
21	2061.957 10(11)	1358.74	0.427E-20	R(39) F	56	2064.260 32(10)*	642.27	0.869E-19	R(24) B
22	2061.957 40(12)	1358.72	0.427E-20	R(39) E	57	2064.385 00(9)	1449.79	0.310E-20	R(44) G
23	2062.147 70(10)*	589.88	0.850E-19	R(18) B	58	2064.526 48(14)*	11.08	0.258E-19	R(7) P
24	2062.156 99(10)*	589.95	0.849E-19	R(18) C	59	2064.584 04(13)*	6.09	0.459E-18	R(5) A
25	2062.291 12(26)	870.29	0.914E-20	R(7) D	60	2064.900 96(14)*	14.25	0.286E-19	R(8) P
26	2062.505 84(10)*	597.60	0.862E-19	R(19) B	61	2064.972 72(13)*	8.52	0.529E-18	R(6) A
27	2062.515 69(10)*	597.68	0.861E-19	R(19) C	62	2065.283 95(10)*	673.94	0.835E-19	R(27) B
28	2062.600 74(3)	619.90	0.384E-20	R(22) Q	63	2065.358 96(13)*	11.36	0.597E-18	R(7) A
29	2062.604 12(13)*	0.00	0.788E-19	R(0) A	64	2065.576 62(3)	716.17	0.336E-20	R(31) Q
30	2062.611 67(3)	620.01	0.384E-20	R(22) R	65	2065.620 31(10)*	685.31	0.818E-19	R(28) B
31	2062.618 50(14)*	1.19	0.101E-19	R(2) P	66	2065.635 34(10)*	685.49	0.818E-19	R(28) C
32	2062.674 89(26)	873.53	0.101E-19	R(8) D	67	2065.642 81(14)*	21.77	0.337E-19	R(10) P
33	2062.871 98(10)*	605.81	0.870E-19	R(20) C	68	2065.742 76(13)*	14.61	0.661E-18	R(8) A
34	2062.878 72(12)	1408.78	0.360E-20	R(42) F	69	2065.954 25(10)*	697.09	0.800E-19	R(29) B
35	2062.879 34(13)	1408.75	0.360E-20	R(42) E	70	2065.969 87(10)*	697.27	0.799E-19	R(29) C

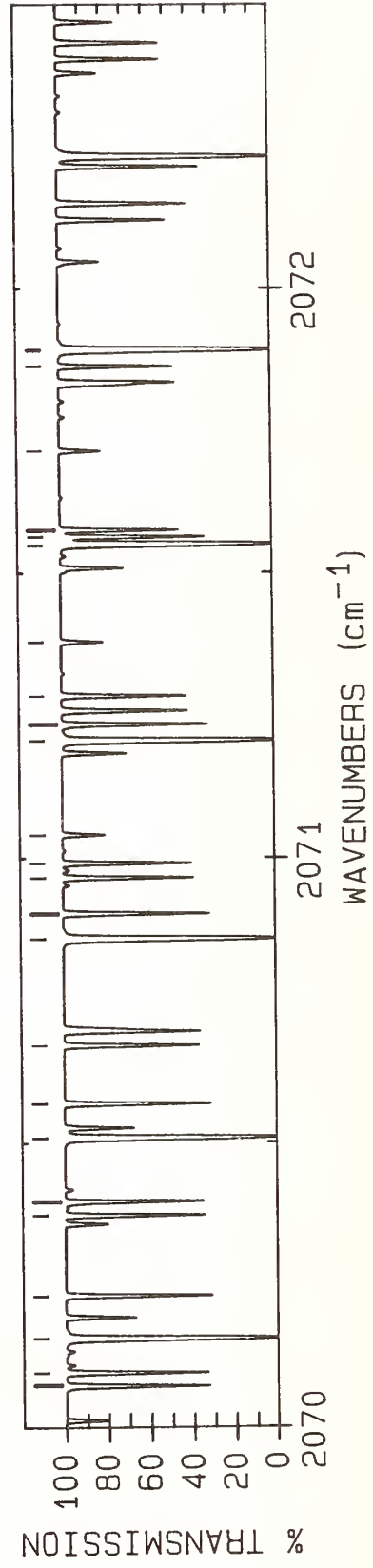
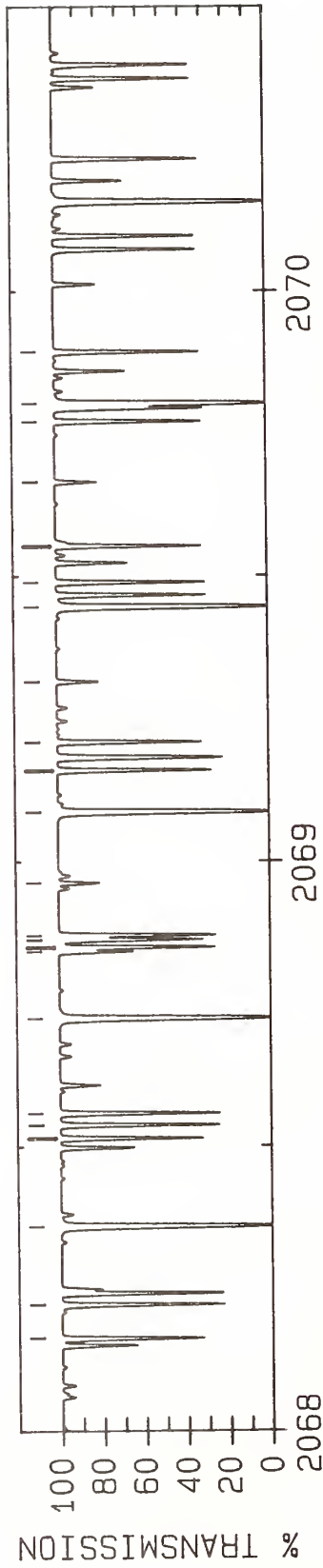
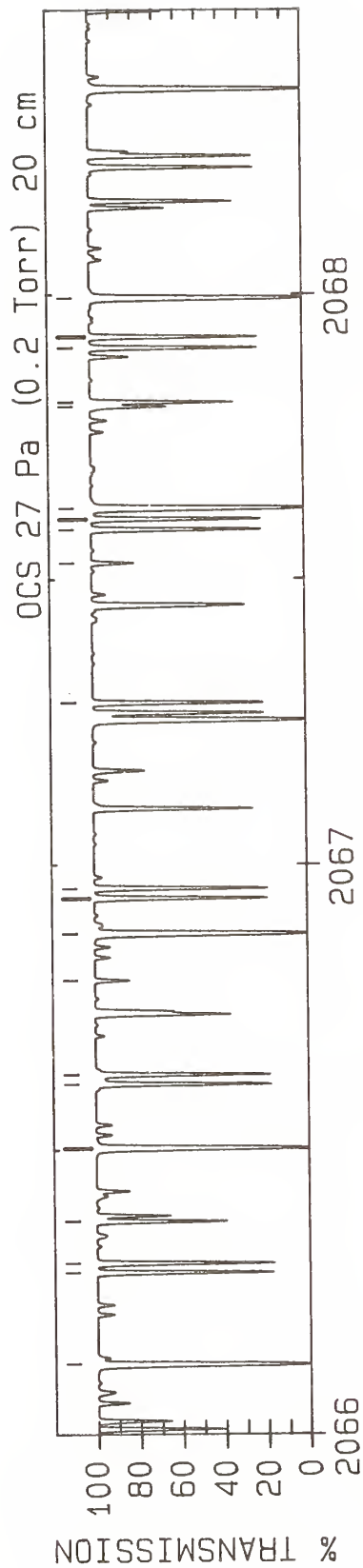

LINE #	WAVENUMBER(unc) (cm ⁻¹)	LOWER STATE (cm ⁻¹)	INTENSITY (cm/molecule)	ASSIGNMENT ROTATION BAND	LINE #	WAVENUMBER(unc) (cm ⁻¹)	LOWER STATE (cm ⁻¹)	INTENSITY (cm/molecule)	ASSIGNMENT ROTATION BAND
1	2066.124 12(13)*	18.26	0.722E-18	R(9) A	36	2069.209 28(14)*	83.11	0.478E-19	R(20) P
2	2066.285 75(10)*	709.27	0.779E-19	R(30) B	37	2069.315 35(5)	76.11	0.849E-20	R(19) L
3	2066.301 97(10)*	709.47	0.778E-19	R(30) C	38	2069.446 33(13)*	69.37	0.107E-17	R(18) A
4	2066.375 15(14)*	30.87	0.381E-19	R(12) P	39	2069.489 34(10)*	853.74	0.511E-19	R(40) C
5	2066.503 04(13)*	22.31	0.779E-18	R(10) A	40	2069.552 81(14)*	91.42	0.481E-19	R(21) P
6	2066.614 83(10)*	721.86	0.756E-19	R(31) B	41	2069.665 39(5)	84.12	0.858E-20	R(20) L
7	2066.631 65(10)*	722.07	0.756E-19	R(31) C	42	2069.771 63(10)*	870.04	0.484E-19	R(41) B
8	2066.797 36(6)	31.25	0.686E-20	R(12) L	43	2069.803 21(13)*	77.08	0.109E-17	R(19) A
9	2066.879 51(13)*	26.78	0.831E-18	R(11) A	44	2069.893 96(14)*	100.13	0.482E-19	R(22) P
10	2066.941 47(10)*	734.85	0.733E-19	R(32) B	45	2070.073 88(10)*	887.08	0.456E-19	R(42) B
11	2066.958 90(10)*	735.07	0.732E-19	R(32) C	46	2070.097 56(10)*	887.47	0.455E-19	R(42) C
12	2067.283 73(10)*	748.49	0.706E-19	R(33) C	47	2070.157 65(13)*	85.19	0.110E-17	R(20) A
13	2067.528 86(6)	42.06	0.751E-20	R(14) L	48	2070.232 71(14)*	109.23	0.482E-19	R(23) P
14	2067.587 46(10)*	762.05	0.681E-19	R(34) B	49	2070.373 69(10)*	904.54	0.429E-19	R(43) B
15	2067.606 12(10)*	762.31	0.680E-19	R(34) C	50	2070.398 01(10)*	904.94	0.428E-19	R(43) C
16	2067.625 13(13)*	36.92	0.924E-18	R(13) A	51	2070.509 62(13)*	93.71	0.110E-17	R(21) A
17	2067.803 34(25)	961.29	0.169E-19	R(22) D	52	2070.569 07(14)*	118.72	0.479E-19	R(24) P
18	2067.811 28(14)*	53.83	0.446E-19	R(16) P	53	2070.671 06(10)*	922.39	0.402E-19	R(44) B
19	2067.906 80(10)*	776.26	0.654E-19	R(35) B	54	2070.859 14(13)*	102.63	0.110E-17	R(22) A
20	2067.926 08(10)*	776.53	0.653E-19	R(35) C	55	2070.903 03(14)*	128.62	0.475E-19	R(25) P
21	2067.994 27(13)*	42.60	0.963E-18	R(14) A	56	2070.965 97(10)*	940.66	0.376E-19	R(45) B
22	2068.164 36(14)*	60.55	0.457E-19	R(17) P	57	2070.991 56(10)*	941.10	0.376E-19	R(45) C
23	2068.223 70(10)*	790.88	0.626E-19	R(36) B	58	2071.041 34(6)	120.17	0.858E-20	R(24) L
24	2068.360 96(13)*	48.68	0.997E-18	R(15) A	59	2071.206 20(13)*	111.96	0.110E-17	R(23) A
25	2068.515 05(14)*	67.68	0.466E-19	R(18) P	60	2071.234 60(14)*	138.90	0.469E-19	R(26) P
26	2068.538 17(10)*	805.90	0.598E-19	R(37) B	61	2071.284 66(10)*	959.78	0.351E-19	R(46) C
27	2068.558 69(10)*	806.20	0.597E-19	R(37) C	62	2071.379 26(6)	130.18	0.850E-20	R(25) L
28	2068.725 20(13)*	55.17	0.103E-17	R(16) A	63	2071.548 46(10)*	978.40	0.327E-19	R(47) B
29	2068.842 46(25)	990.41	0.166E-19	R(25) D	64	2071.563 77(14)*	149.59	0.462E-19	R(27) P
30	2068.850 19(10)*	821.33	0.569E-19	R(38) B	65	2071.575 31(10)*	978.88	0.326E-19	R(47) C
31	2068.863 36(14)*	75.19	0.473E-19	R(19) P	66	2071.714 75(6)	140.59	0.839E-20	R(26) L
32	2068.871 35(10)*	821.64	0.568E-19	R(38) C	67	2071.863 51(10)*	998.38	0.303E-19	R(48) C
33	2068.962 89(5)	68.50	0.837E-20	R(18) L	68	2071.890 55(14)*	160.67	0.454E-19	R(28) P
34	2069.086 99(13)*	62.07	0.105E-17	R(17) A	69	2071.892 94(13)*	131.84	0.108E-17	R(25) A
35	2069.159 78(10)*	837.16	0.541E-19	R(39) B					

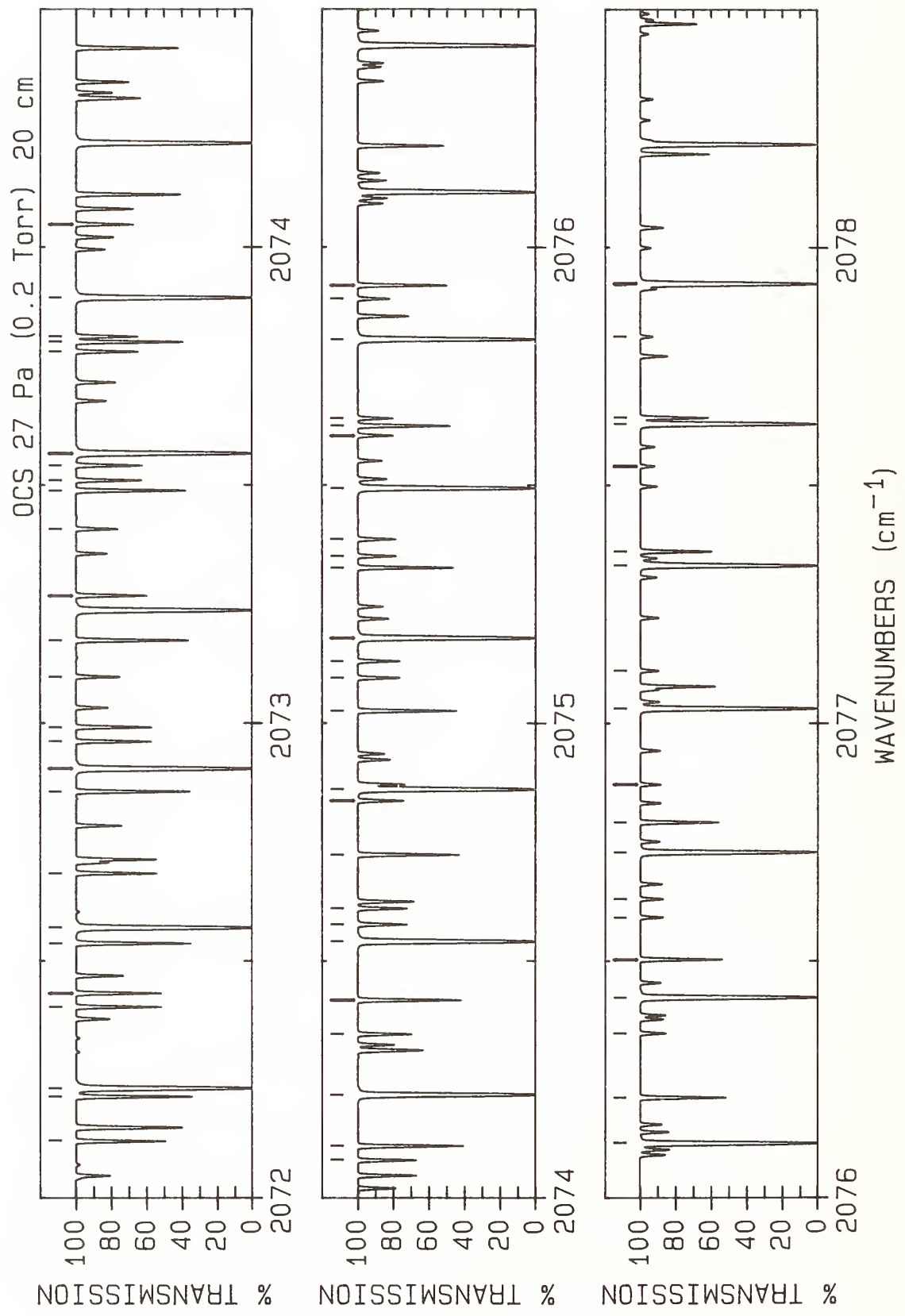

LINE #	WAVENUMBER(unc) (cm ⁻¹)	LOWER STATE (cm ⁻¹)	INTENSITY (cm/molecule)	ASSIGNMENT ROTATION BAND	LINE #	WAVENUMBER(unc) (cm ⁻¹)	LOWER STATE (cm ⁻¹)	INTENSITY (cm/molecule)	ASSIGNMENT ROTATION BAND
1	2072.121 13(10)*	1017.76	0.281E-19	R(49) B	36	2074.861 20(13)*	241.34	0.858E-18	R(34) A
2	2072.214 92(14)*	172.14	0.444E-19	R(29) P	37	2075.026 10(14)*	293.19	0.321E-19	R(38) P
3	2072.232 61(13)*	142.38	0.107E-17	R(26) A	38	2075.095 10(10)*	1263.19	0.104E-19	R(60) B
4	2072.403 78(10)*	1038.05	0.260E-19	R(50) B	39	2075.130 11(11)*	1263.97	0.104E-19	R(60) C
5	2072.432 55(10)*	1038.59	0.260E-19	R(50) C	40	2075.178 65(13)*	255.53	0.824E-18	R(35) A
6	2072.536 90(14)*	184.01	0.433E-19	R(30) P	41	2075.326 41(14)*	308.62	0.305E-19	R(39) P
7	2072.569 83(13)*	153.34	0.105E-17	R(27) A	42	2075.350 68(11)*	1287.93	0.940E-20	R(61) B
8	2072.683 98(10)*	1058.74	0.240E-19	R(51) B	43	2075.386 30(11)*	1288.73	0.937E-20	R(61) C
9	2072.856 47(14)*	196.27	0.421E-19	R(31) P	44	2075.493 62(13)*	270.13	0.789E-18	R(36) A
10	2072.904 57(13)*	164.69	0.103E-17	R(28) A	45	2075.603 80(11)*	1313.07	0.846E-20	R(62) B
11	2072.961 73(10)*	1079.84	0.221E-19	R(52) B	46	2075.624 30(14)*	324.44	0.290E-19	R(40) P
12	2072.991 76(10)*	1080.42	0.220E-19	R(52) C	47	2075.640 02(11)*	1313.90	0.842E-20	R(62) C
13	2073.097 27(25)	1158.61	0.110E-19	R(38) D	48	2075.806 12(13)*	285.13	0.753E-18	R(37) A
14	2073.173 64(14)*	208.93	0.409E-19	R(32) P	49	2075.891 26(11)*	1339.47	0.756E-20	R(63) C
15	2073.267 68(10)*	1101.95	0.202E-19	R(53) C	50	2075.919 77(14)*	340.66	0.274E-19	R(41) P
16	2073.407 71(25)	1174.37	0.105E-19	R(39) D	51	2076.116 13(13)*	300.54	0.717E-18	R(38) A
17	2073.488 40(14)*	221.99	0.395E-19	R(33) P	52	2076.212 83(14)*	357.27	0.259E-19	R(42) P
18	2073.509 84(10)*	1123.25	0.185E-19	R(54) B	53	2076.348 34(11)*	1390.93	0.607E-20	R(65) B
19	2073.541 14(10)*	1123.88	0.185E-19	R(54) C	54	2076.423 67(13)*	316.35	0.681E-18	R(39) A
20	2073.566 66(13)*	188.62	0.981E-18	R(30) A	55	2076.503 47(14)*	374.27	0.244E-19	R(43) P
21	2073.780 21(10)*	1145.56	0.169E-19	R(55) B	56	2076.591 58(11)*	1417.69	0.541E-20	R(66) B
22	2073.800 76(14)*	235.44	0.381E-19	R(34) P	57	2076.630 15(11)*	1418.62	0.539E-20	R(66) C
23	2073.812 13(10)*	1146.22	0.169E-19	R(55) C	58	2076.728 72(13)*	332.57	0.646E-18	R(40) A
24	2073.894 00(13)*	201.19	0.953E-18	R(31) A	59	2076.791 69(14)*	391.68	0.230E-19	R(44) P
25	2074.048 11(10)*	1168.28	0.155E-19	R(56) B	60	2076.871 49(11)*	1445.81	0.479E-20	R(67) C
26	2074.080 66(10)*	1168.96	0.154E-19	R(56) C	61	2077.031 29(13)*	349.19	0.610E-18	R(41) A
27	2074.110 71(14)*	249.29	0.366E-19	R(35) P	62	2077.110 35(11)*	1473.41	0.425E-20	R(68) C
28	2074.218 88(13)*	214.17	0.923E-18	R(32) A	63	2077.331 37(13)*	366.22	0.575E-18	R(42) A
29	2074.346 72(10)*	1192.10	0.140E-19	R(57) C	64	2077.360 86(14)*	427.66	0.201E-19	R(46) P
30	2074.418 25(14)*	263.53	0.351E-19	R(36) P	65	2077.539 82(12)*	1528.76	0.334E-20	R(70) B
31	2074.541 27(13)*	227.55	0.891E-18	R(33) A	66	2077.628 97(12)*	383.65	0.541E-18	R(43) A
32	2074.576 53(10)*	1214.93	0.128E-19	R(58) B	67	2077.641 81(14)*	446.25	0.188E-19	R(47) P
33	2074.610 32(10)*	1215.65	0.127E-19	R(58) C	68	2077.812 05(12)*	1558.62	0.293E-20	R(71) C
34	2074.723 38(14)*	278.16	0.336E-19	R(37) P	69	2077.920 33(14)*	465.23	0.175E-19	R(48) P
35	2074.837 05(10)*	1238.86	0.115E-19	R(59) B	70	2077.924 08(12)*	401.49	0.507E-18	R(44) A

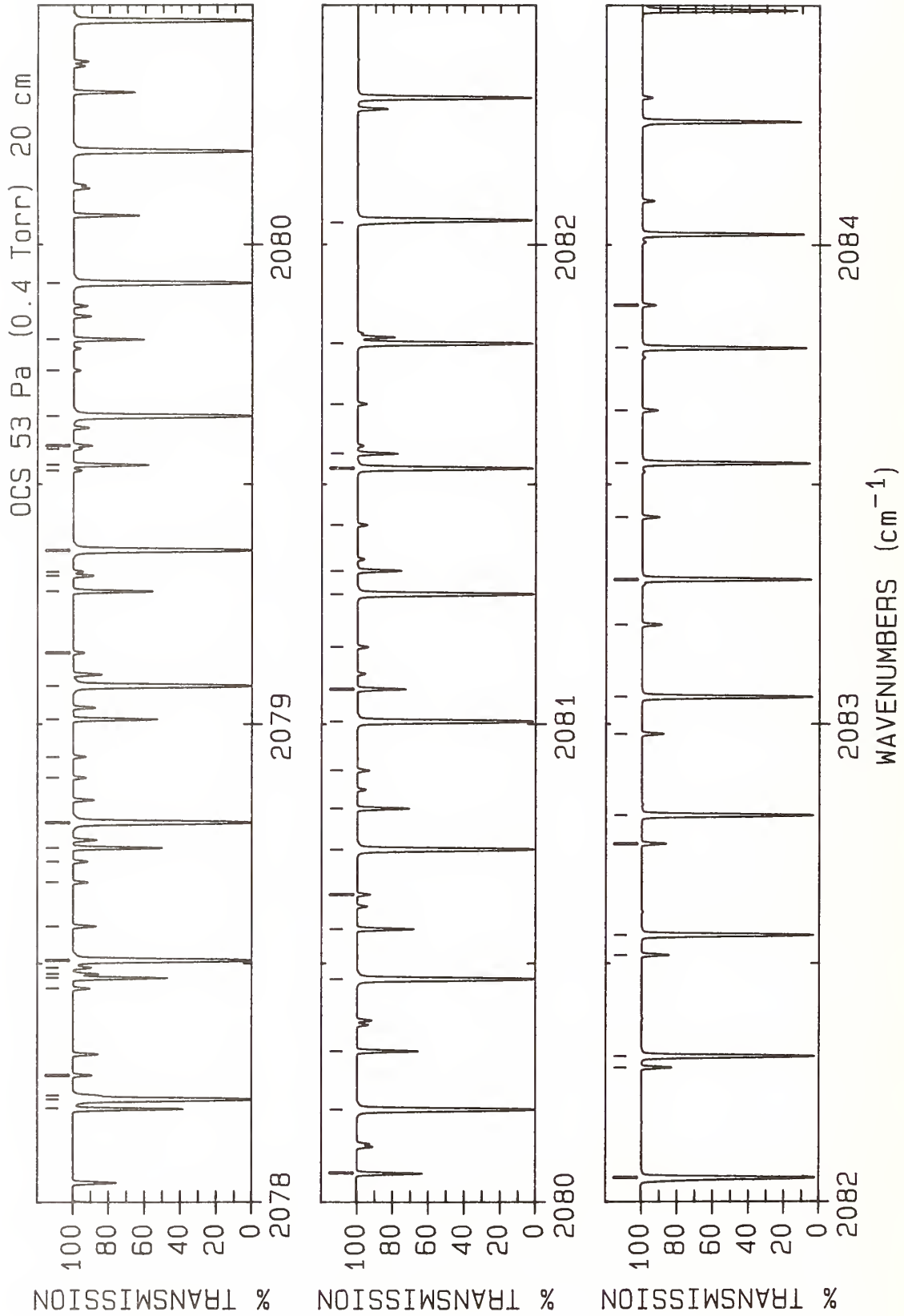

LINE #	WAVENUMBER(unc) (cm ⁻¹)	LOWER STATE (cm ⁻¹)	INTENSITY (cm/molecule)	ASSIGNMENT ROTATION BAND	LINE #	WAVENUMBER(unc) (cm ⁻¹)	LOWER STATE (cm ⁻¹)	INTENSITY (cm/molecule)	ASSIGNMENT ROTATION BAND
1	2078.196 43(14)*	484.60	0.163E-19	R(49)	36	2080.195 27(12)*	558.74	0.278E-18	R(52)
2	2078.196 86(8)	451.67	0.330E-20	R(47)	37	2080.317 71(14)*	653.80	0.829E-20	R(57)
3	2078.216 71(12)*	419.73	0.474E-18	R(45)	38	2080.467 93(12)*	580.22	0.256E-18	R(53)
4	2078.225 03(13)*	1616.30	0.228E-20	R(73)	39	2080.571 92(14)*	676.72	0.754E-20	R(58)
5	2078.267 43(13)*	1617.44	0.227E-20	R(73)	40	2080.643 90(10)	638.93	0.158E-20	R(56)
6	2078.448 48(14)*	1646.29	0.200E-20	R(74)	41	2080.738 10(12)*	602.10	0.234E-18	R(54)
7	2078.470 10(14)*	504.37	0.151E-19	R(50)	42	2080.823 68(14)*	700.04	0.685E-20	R(59)
8	2078.478 60(8)	470.88	0.307E-20	R(48)	43	2080.903 48(11)	661.74	0.144E-20	R(57)
9	2078.491 40(13)*	1647.46	0.198E-20	R(74)	44	2081.005 76(12)*	624.39	0.214E-18	R(55)
10	2078.506 84(12)*	438.37	0.443E-18	R(46)	45	2081.073 01(14)*	723.75	0.621E-20	R(60)
11	2078.577 52(26)	1527.13	0.274E-20	R(57)	46	2081.160 58(12)	684.94	0.131E-20	R(58)
12	2078.669 46(15)*	1676.68	0.174E-20	R(75)	47	2081.270 92(12)*	647.08	0.195E-18	R(56)
13	2078.712 88(14)*	1677.89	0.173E-20	R(75)	48	2081.319 90(14)*	747.86	0.561E-20	R(61)
14	2078.741 34(14)*	524.53	0.139E-19	R(51)	49	2081.415 22(14)	708.54	0.118E-20	R(59)
15	2078.794 48(12)*	457.42	0.412E-18	R(47)	50	2081.533 58(12)*	670.17	0.177E-18	R(57)
16	2078.887 96(16)*	1707.48	0.152E-20	R(76)	51	2081.564 34(14)*	772.36	0.506E-20	R(62)
17	2078.931 87(15)*	1708.71	0.151E-20	R(76)	52	2081.667 39(17)	732.54	0.107E-20	R(60)
18	2079.010 15(14)*	545.09	0.128E-19	R(52)	53	2081.793 73(12)*	693.67	0.161E-18	R(58)
19	2079.079 63(12)*	476.88	0.383E-18	R(48)	54	2082.045 91(14)*	822.54	0.409E-20	R(64)
20	2079.148 38(17)*	1739.94	0.132E-20	R(77)	55	2082.051 38(12)*	717.57	0.146E-18	R(59)
21	2079.276 53(14)*	566.04	0.118E-19	R(53)	56	2082.283 03(14)*	848.22	0.367E-20	R(65)
22	2079.309 05(9)	530.90	0.243E-20	R(51)	57	2082.306 52(12)*	741.87	0.132E-18	R(60)
23	2079.317 53(19)*	1770.28	0.115E-20	R(78)	58	2082.517 70(14)*	874.29	0.328E-20	R(66)
24	2079.361 54(27)	1598.62	0.204E-20	R(60)	59	2082.559 15(12)*	766.58	0.119E-18	R(61)
25	2079.362 28(12)*	496.74	0.355E-18	R(49)	60	2082.749 93(14)*	900.76	0.293E-20	R(67)
26	2079.362 40(18)*	1771.58	0.114E-20	R(78)	61	2082.809 28(12)*	791.70	0.107E-18	R(62)
27	2079.528 60(21)*	1802.28	0.998E-21	R(79)	62	2082.979 71(14)*	927.63	0.261E-20	R(68)
28	2079.540 48(14)*	587.39	0.109E-19	R(54)	63	2083.056 89(12)*	817.21	0.959E-19	R(63)
29	2079.573 93(20)*	1803.61	0.991E-21	R(79)	64	2083.207 05(14)*	954.88	0.232E-20	R(69)
30	2079.580 95(9)	551.71	0.224E-20	R(52)	65	2083.301 99(12)*	843.13	0.858E-19	R(64)
31	2079.642 44(12)*	517.00	0.328E-18	R(50)	66	2083.431 94(15)*	982.53	0.206E-20	R(70)
32	2079.737 20(23)*	1834.68	0.863E-21	R(80)	67	2083.544 58(12)*	869.46	0.767E-19	R(65)
33	2079.801 99(14)*	609.13	0.994E-20	R(55)	68	2083.654 38(15)*	1010.57	0.182E-20	R(71)
34	2079.920 10(12)*	537.67	0.303E-18	R(51)	69	2083.784 66(12)*	896.18	0.684E-19	R(66)
35	2080.061 07(14)*	631.27	0.909E-20	R(56)	70	2083.874 38(16)*	1039.01	0.161E-20	R(72)

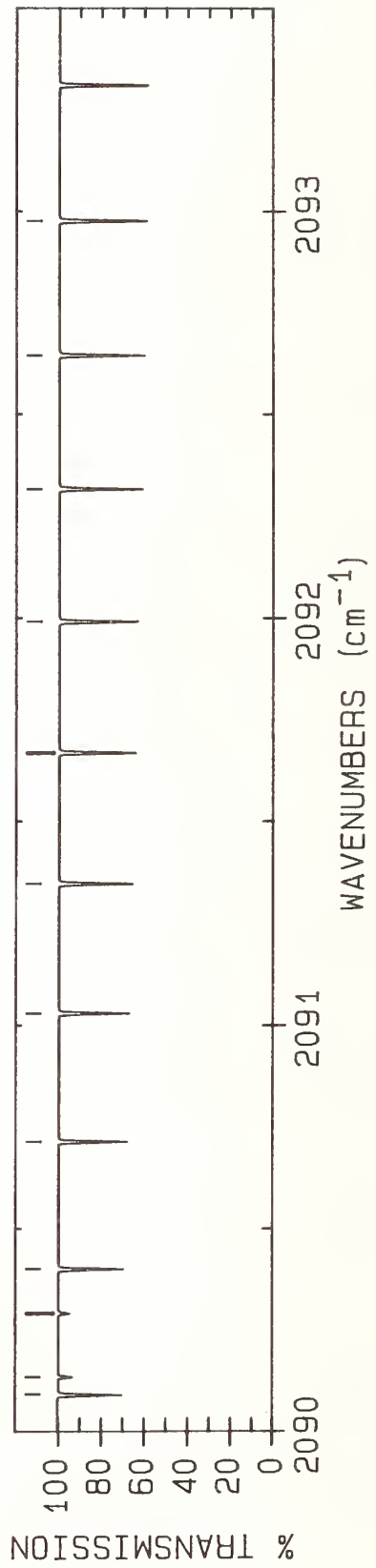
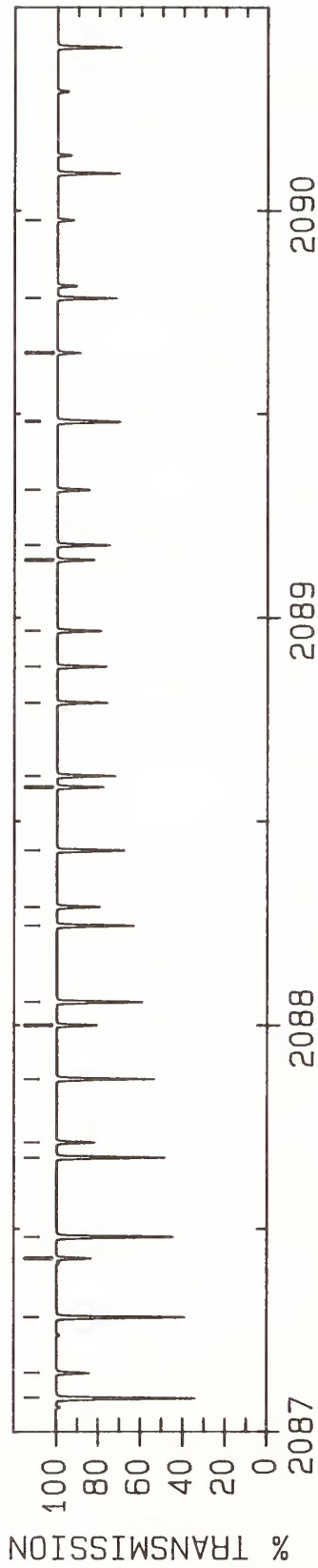
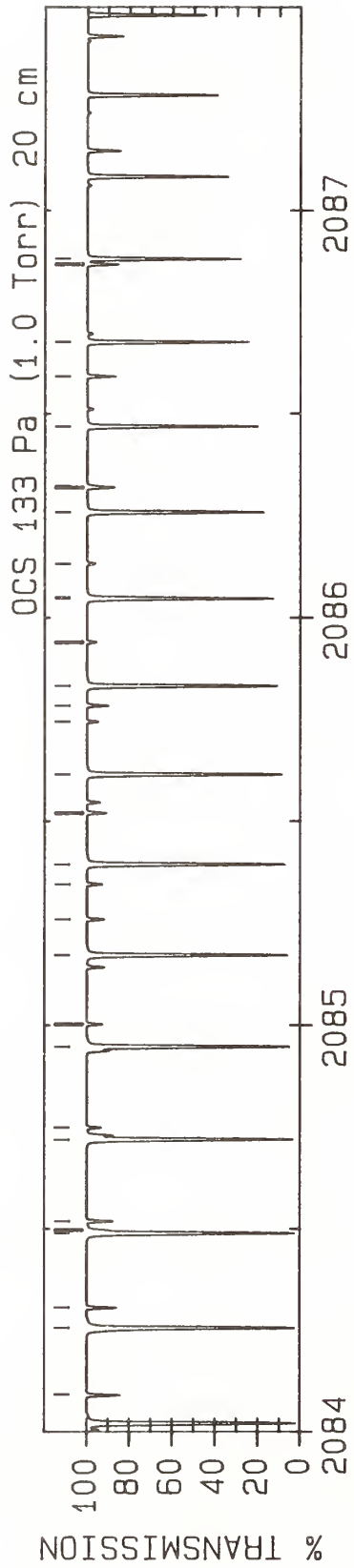

LINE #	WAVENUMBER(unc) (cm ⁻¹)	LOWER STATE (cm ⁻¹)	INTENSITY (cm/molecule)	ASSIGNMENT ROTATION BAND	LINE #	WAVENUMBER(unc) (cm ⁻¹)	LOWER STATE (cm ⁻¹)	INTENSITY (cm/molecule)	ASSIGNMENT ROTATION BAND
1	2084.091 93(17)*	1067.84	0.142E-20	R(73) P	36	2087.480 68(13)*	1412.21	0.699E-20	R(83) A
2	2084.257 27(12)*	950.85	0.540E-19	R(68) A	37	2087.675 39(13)*	1446.18	0.600E-20	R(84) A
3	2084.307 03(18)*	1097.06	0.124E-20	R(74) P	38	2087.712 63(9)*	496.74	0.165E-20	P(49) W
4	2084.489 80(12)*	978.78	0.478E-19	R(69) A	39	2087.867 57(13)*	1480.56	0.514E-20	R(85) A
5	2084.497 85(10)*	766.58	0.533E-21	P(61) W	40	2088.000 04(9)*	476.88	0.178E-20	P(48) W
6	2084.519 68(19)*	1126.67	0.109E-20	R(75) P	41	2088.057 22(13)*	1515.34	0.439E-20	R(86) A
7	2084.719 82(12)*	1007.13	0.423E-19	R(70) A	42	2088.244 35(13)*	1550.53	0.374E-20	R(87) A
8	2084.748 73(10)*	741.87	0.594E-21	P(60) W	43	2088.290 35(9)*	457.42	0.192E-20	P(47) W
9	2084.947 32(12)*	1035.87	0.373E-19	R(71) A	44	2088.428 95(13)*	1586.11	0.318E-20	R(88) A
10	2085.002 79(9)*	717.57	0.659E-21	P(59) W	45	2088.583 52(9)*	438.37	0.207E-20	P(46) W
11	2085.172 30(12)*	1065.02	0.328E-19	R(72) A	46	2088.611 01(13)*	1622.10	0.270E-20	R(89) A
12	2085.259 98(9)*	693.67	0.731E-21	P(58) W	47	2088.790 55(13)*	1658.48	0.229E-20	R(90) A
13	2085.345 79(27)	1249.06	0.635E-21	R(79) P	48	2088.879 54(9)*	419.73	0.222E-20	P(45) W
14	2085.394 76(12)*	1094.57	0.288E-19	R(73) A	49	2088.967 56(13)*	1695.27	0.194E-20	R(91) A
15	2085.520 30(9)*	670.17	0.808E-21	P(57) W	50	2089.142 03(13)*	1732.46	0.163E-20	R(92) A
16	2085.614 71(12)*	1124.52	0.252E-19	R(74) A	51	2089.178 38(9)*	401.49	0.237E-20	P(44) W
17	2085.744 16(33)	1312.61	0.478E-21	R(81) P	52	2089.313 98(13)*	1770.05	0.137E-20	R(93) A
18	2085.783 72(9)*	647.08	0.890E-21	P(56) W	53	2089.480 02(9)*	383.65	0.253E-20	P(43) W
19	2085.832 13(12)*	1154.87	0.221E-19	R(75) A	54	2089.483 39(14)*	1808.05	0.116E-20	R(94) A
20	2085.939 67(36)	1344.97	0.413E-21	R(82) P	55	2089.650 27(14)*	1846.44	0.969E-21	R(95) A
21	2086.047 03(13)*	1185.63	0.193E-19	R(76) A	56	2089.784 43(9)*	366.22	0.270E-20	P(42) W
22	2086.050 23(9)*	624.39	0.979E-21	P(55) W	57	2089.976 43(16)	1924.43	0.677E-21	R(97) A
23	2086.132 73(40)	1377.73	0.357E-21	R(83) P	58	2090.091 60(9)*	349.19	0.287E-20	P(41) W
24	2086.259 41(13)*	1216.79	0.168E-19	R(77) A	59	2090.135 71(18)	1964.03	0.564E-21	R(98) A
25	2086.319 78(9)*	602.10	0.107E-20	P(54) W	60	2090.292 45(20)	2004.02	0.469E-21	R(99) A
26	2086.323 35(45)	1410.88	0.307E-21	R(84) P	61	2090.401 49(9)*	332.57	0.303E-20	P(40) W
27	2086.469 26(13)*	1248.35	0.146E-19	R(78) A	62	2090.714 08(9)*	316.35	0.321E-20	P(39) W
28	2086.592 38(9)*	580.22	0.118E-20	P(53) W	63	2091.029 36(9)*	300.54	0.338E-20	P(38) W
29	2086.676 60(13)*	1280.32	0.126E-19	R(79) A	64	2091.347 31(9)*	285.13	0.355E-20	P(37) W
30	2086.867 98(9)*	558.74	0.129E-20	P(52) W	65	2091.667 89(9)*	270.13	0.372E-20	P(36) W
31	2086.881 41(13)*	1312.69	0.109E-19	R(80) A	66	2091.991 09(9)*	255.53	0.388E-20	P(35) W
32	2087.083 69(13)*	1345.46	0.944E-20	R(81) A	67	2092.316 88(9)*	241.34	0.404E-20	P(34) W
33	2087.146 58(9)*	537.67	0.140E-20	P(51) W	68	2092.645 26(9)*	227.55	0.420E-20	P(33) W
34	2087.283 45(13)*	1378.63	0.813E-20	R(82) A	69	2092.976 19(9)*	214.17	0.435E-20	P(32) W
35	2087.428 13(9)*	517.00	0.152E-20	P(50) W					

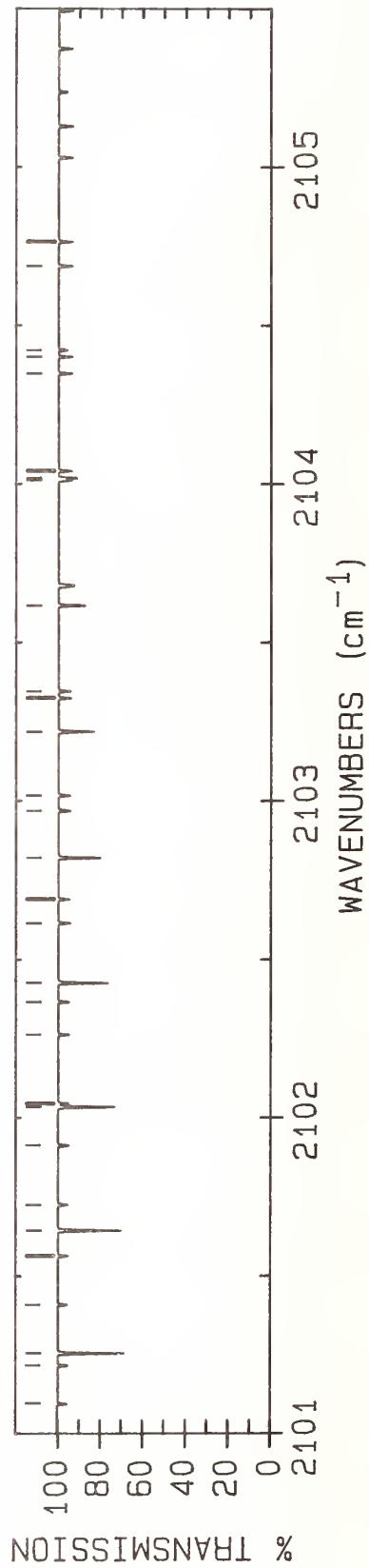
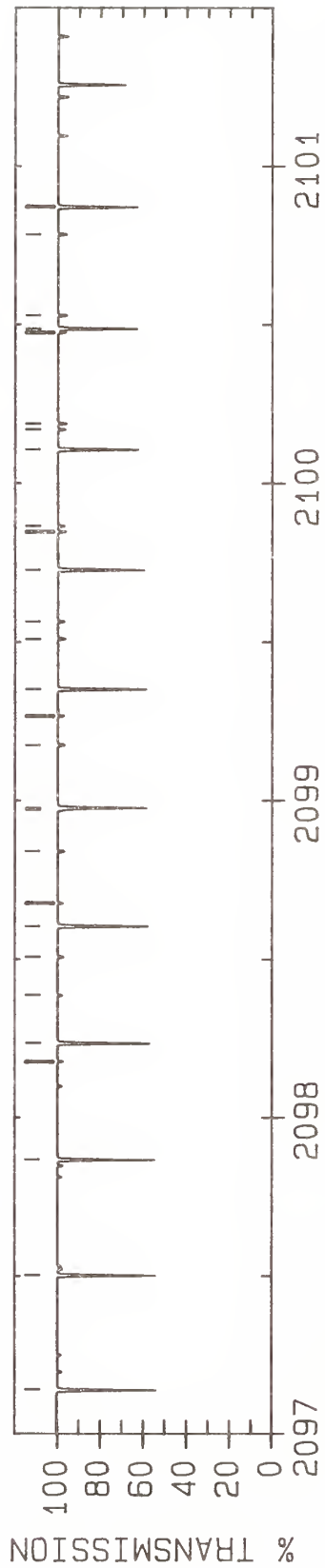
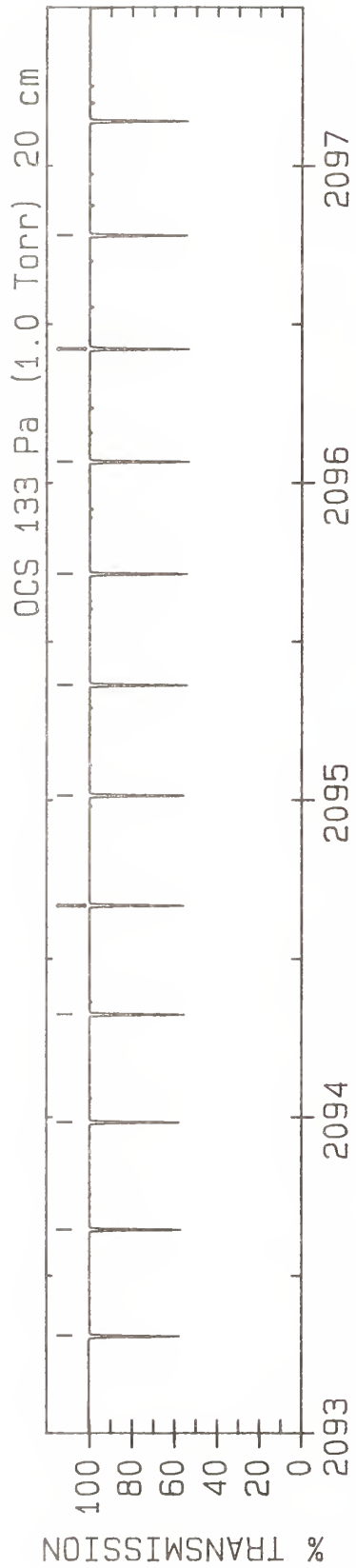

LINE #	WAVENUMBER(unc) (cm ⁻¹)	LOWER STATE (cm ⁻¹)	INTENSITY (cm/molecule)	ASSIGNMENT ROTATION BAND	LINE #	WAVENUMBER(unc) (cm ⁻¹)	LOWER STATE (cm ⁻¹)	INTENSITY (cm/molecule)	ASSIGNMENT ROTATION BAND
1	2093.309 67(9)*	201.19	0.449E-20	P(31) W	36	2100.487 58(9)*	26.78	0.375E-20	P(11) W
2	2093.645 66(9)*	188.62	0.462E-20	P(30) W	37	2100.529 23(15)	837.16	0.387E-21	P(39) Y
3	2093.984 15(9)*	176.45	0.475E-20	P(29) W	38	2100.784 33(15)	853.74	0.367E-21	P(40) Z
4	2094.325 13(9)*	164.69	0.485E-20	P(28) W	39	2100.870 92(9)*	22.31	0.348E-20	P(10) W
5	2094.668 58(9)*	153.34	0.495E-20	P(27) W	40	2100.872 47(15)	821.33	0.408E-21	P(38) Y
6	2095.014 48(9)*	142.38	0.503E-20	P(26) W	41	2101.095 65(15)	837.49	0.387E-21	P(39) Z
7	2095.362 81(9)*	131.84	0.509E-20	P(25) W	42	2101.217 50(15)	805.90	0.429E-21	P(37) Y
8	2095.713 56(9)*	121.70	0.514E-20	P(24) W	43	2101.256 51(9)*	18.26	0.320E-20	P(9) W
9	2096.066 72(9)*	111.96	0.516E-20	P(23) W	44	2101.409 52(15)	821.64	0.407E-21	P(38) Z
10	2096.422 27(9)*	102.63	0.517E-20	P(22) W	45	2101.564 30(15)	790.88	0.449E-21	P(36) Y
11	2096.780 19(9)*	93.71	0.515E-20	P(21) W	46	2101.644 36(9)*	14.61	0.289E-20	P(8) W
12	2097.140 48(9)*	85.19	0.512E-20	P(20) W	47	2101.725 95(14)	806.20	0.428E-21	P(37) Z
13	2097.503 12(9)*	77.08	0.506E-20	P(19) W	48	2101.912 87(15)	776.26	0.469E-21	P(35) Y
14	2097.868 10(9)*	69.37	0.498E-20	P(18) W	49	2102.034 46(9)*	11.36	0.257E-20	P(7) W
15	2098.177 54(19)	959.33	0.251E-21	P(46) Y	50	2102.044 92(14)	791.16	0.448E-21	P(36) Z
16	2098.235 41(9)*	62.07	0.487E-20	P(17) W	51	2102.263 19(15)	762.05	0.487E-21	P(34) Y
17	2098.386 93(23)	998.38	0.218E-21	P(48) Z	52	2102.366 42(14)	776.53	0.468E-21	P(35) Z
18	2098.507 94(18)	940.66	0.270E-21	P(45) Y	53	2102.426 79(9)*	8.52	0.224E-20	P(6) W
19	2098.605 03(9)*	55.17	0.474E-20	P(16) W	54	2102.615 26(15)	748.25	0.505E-21	P(33) Y
20	2098.677 47(22)	978.88	0.234E-21	P(47) Z	55	2102.690 45(14)	762.31	0.487E-21	P(34) Z
21	2098.840 22(17)	922.39	0.288E-21	P(44) Y	56	2102.821 36(9)*	6.09	0.189E-20	P(5) W
22	2098.970 64(20)	959.78	0.251E-21	P(46) Z	57	2102.969 06(15)	734.85	0.525E-21	P(32) Y
23	2098.976 97(9)*	48.68	0.459E-20	P(15) W	58	2103.017 00(14)	748.49	0.505E-21	P(33) Z
24	2099.174 35(16)	904.54	0.308E-21	P(43) Y	59	2103.218 17(9)*	4.06	0.152E-20	P(4) W
25	2099.266 43(19)	941.10	0.270E-21	P(45) Z	60	2103.324 59(15)	721.86	0.540E-21	P(31) Y
26	2099.351 20(9)*	42.60	0.441E-20	P(14) W	61	2103.346 06(14)	735.07	0.525E-21	P(32) Z
27	2099.510 34(16)	887.08	0.327E-21	P(42) Y	62	2103.617 21(9)*	2.43	0.115E-20	P(3) W
28	2099.564 82(18)	922.82	0.288E-21	P(44) Z	63	2104.011 69(14)	709.47	0.555E-21	P(30) Z
29	2099.727 71(9)*	36.92	0.421E-20	P(13) W	64	2104.018 47(9)*	1.22	0.773E-21	P(2) W
30	2099.848 15(16)	870.04	0.347E-21	P(41) Y	65	2104.040 79(14)	697.09	0.570E-21	P(29) Y
31	2099.865 82(17)	904.94	0.307E-21	P(43) Z	66	2104.348 25(14)	697.27	0.570E-21	P(29) Z
32	2100.106 51(9)*	31.64	0.399E-20	P(12) W	67	2104.401 45(14)	685.31	0.585E-21	P(28) Y
33	2100.169 41(16)	887.47	0.327E-21	P(42) Z	68	2104.421 96(9)*	0.41	0.388E-21	P(1) W
34	2100.187 79(15)	853.39	0.368E-21	P(40) Y	69	2104.687 29(14)	685.49	0.585E-21	P(28) Z
35	2100.475 58(15)	870.40	0.346E-21	P(41) Z	70	2104.763 80(14)	673.94	0.595E-21	P(27) Y

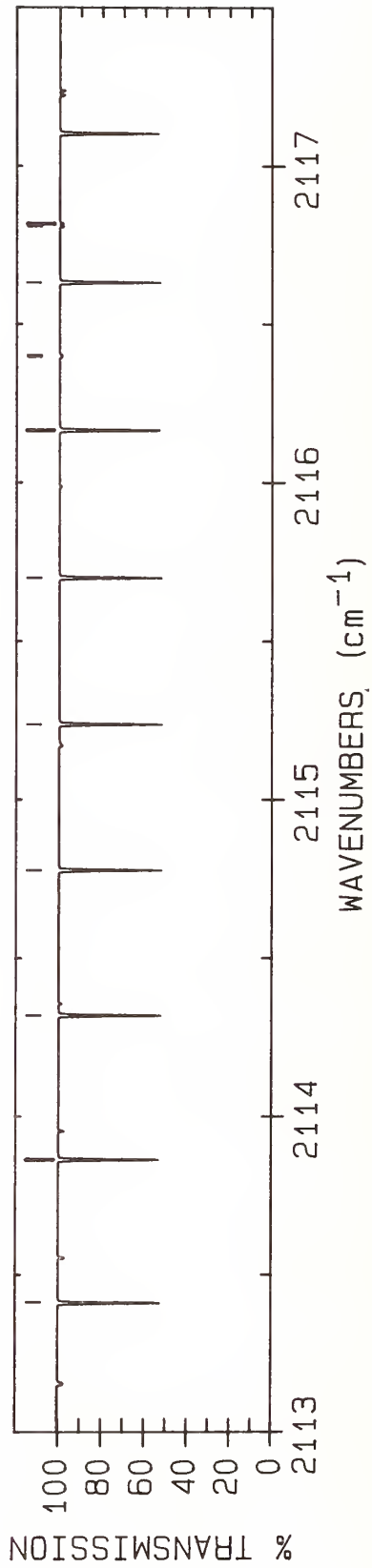
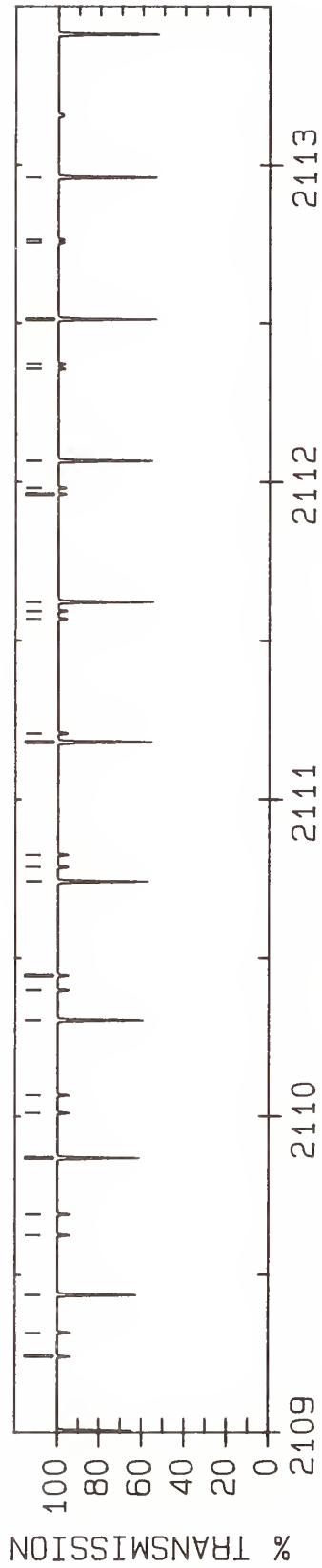
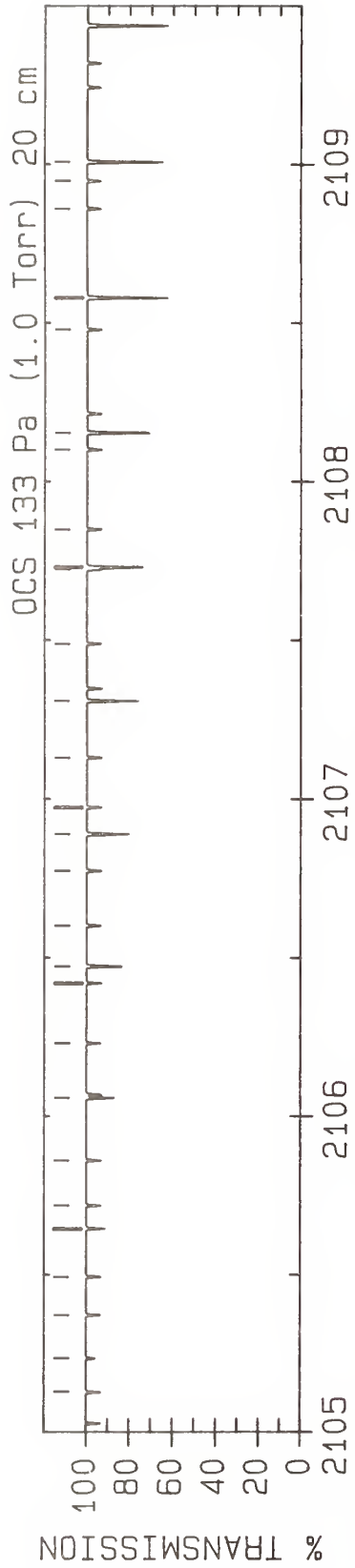

LINE #	WAVENUMBER(cm^{-1})	LOWER STATE (cm^{-1})	INTENSITY (cm^2/mole)	ASSIGNMENT ROTATION BAND	LINE #	WAVENUMBER(unc) (cm^{-1})	LOWER STATE (cm^{-1})	INTENSITY (cm^2/mole)	ASSIGNMENT ROTATION BAND
1	2105.127 84(14)	662.98	0.604E-21	P(26) Y	36	2110.011 13(14)	557.38	0.504E-21	P(13) Y
2	2105.235 61(9)*	0.00	0.389E-21	R(0) W	37	2110.067 04(14)	557.42	0.504E-21	P(13) Z
3	2105.372 80(14)	663.13	0.604E-21	P(26) Z	38	2110.304 60(9)*	31.64	0.435E-20	R(12) W
4	2105.493 56(14)	652.42	0.612E-21	P(25) Y	39	2110.398 18(14)	552.11	0.477E-21	P(12) Y
5	2105.645 77(9)*	0.41	0.777E-21	R(1) W	40	2110.445 06(14)	552.14	0.477E-21	P(12) Z
6	2105.719 26(14)	652.56	0.611E-21	P(25) Z	41	2110.741 59(9)*	36.92	0.456E-20	R(13) W
7	2105.860 96(14)	642.27	0.617E-21	P(24) Y	42	2110.786 85(14)	547.23	0.447E-21	P(11) Y
8	2106.058 15(9)*	1.22	0.116E-20	R(2) W	43	2110.825 49(14)	547.26	0.447E-21	P(11) Z
9	2106.230 02(14)	632.52	0.620E-21	P(23) Y	44	2111.177 12(14)	542.76	0.415E-21	P(10) Y
10	2106.419 54(14)	632.64	0.620E-21	P(23) Z	45	2111.180 85(9)*	42.60	0.476E-20	R(14) W
11	2106.472 75(9)*	2.43	0.154E-20	R(3) W	46	2111.208 31(14)	542.79	0.415E-21	P(10) Z
12	2106.600 74(14)	623.18	0.621E-21	P(22) Y	47	2111.568 99(14)	538.70	0.380E-21	P(9) Y
13	2106.773 36(14)	623.29	0.620E-21	P(22) Z	48	2111.593 52(14)	538.72	0.380E-21	P(9) Z
14	2106.889 58(9)*	4.06	0.191E-20	R(4) W	49	2111.622 39(9)*	48.68	0.493E-20	R(15) W
15	2106.973 12(14)	614.25	0.619E-21	P(21) Y	50	2111.962 47(14)	535.04	0.343E-21	P(8) Y
16	2107.129 62(14)	614.35	0.619E-21	P(21) Z	51	2111.981 12(14)	535.06	0.343E-21	P(8) Z
17	2107.308 63(9)*	6.09	0.227E-20	R(5) W	52	2112.066 21(9)*	55.17	0.507E-20	R(16) W
18	2107.488 32(14)	605.81	0.614E-21	P(20) Z	53	2112.357 55(14)	531.80	0.303E-21	P(7) Y
19	2107.722 83(14)	597.60	0.607E-21	P(19) Y	54	2112.371 11(14)	531.81	0.303E-21	P(7) Z
20	2107.729 92(9)*	8.52	0.262E-20	R(6) W	55	2112.512 32(9)*	62.07	0.519E-20	R(17) W
21	2107.849 45(14)	597.68	0.607E-21	P(19) Z	56	2112.754 22(14)	528.95	0.262E-21	P(6) Y
22	2108.100 14(14)	589.88	0.597E-21	P(18) Y	57	2112.763 48(14)	528.96	0.262E-21	P(6) Z
23	2108.153 43(9)*	11.36	0.295E-20	R(7) W	58	2112.960 73(9)*	69.37	0.529E-20	R(18) W
24	2108.479 08(14)	582.57	0.584E-21	P(17) Y	59	2113.411 45(9)*	77.08	0.537E-20	R(19) W
25	2108.578 98(14)	582.63	0.584E-21	P(17) Z	60	2113.864 49(9)*	85.19	0.542E-20	R(20) W
26	2108.579 18(9)*	14.61	0.327E-20	R(8) W	61	2114.319 87(9)*	93.71	0.544E-20	R(21) W
27	2108.859 66(14)	575.66	0.568E-21	P(16) Y	62	2114.777 58(9)*	102.63	0.545E-20	R(22) W
28	2108.947 38(14)	575.72	0.568E-21	P(16) Z	63	2115.237 66(9)*	111.96	0.544E-20	R(23) W
29	2109.007 16(9)*	18.26	0.357E-20	R(9) W	64	2115.700 10(9)*	121.70	0.540E-20	R(24) W
30	2109.241 86(14)	569.16	0.550E-21	P(15) Y	65	2116.164 92(9)*	131.84	0.534E-20	R(25) W
31	2109.318 19(14)	569.22	0.550E-21	P(15) Z	66	2116.395 78(15)	521.64	0.124E-21	R(2) Y
32	2109.437 39(9)*	22.31	0.385E-20	R(10) W	67	2116.401 78(15)	521.64	0.124E-21	R(2) Z
33	2109.625 69(14)	563.07	0.528E-21	P(14) Y	68	2116.632 14(9)*	142.38	0.527E-20	R(26) W
34	2109.691 41(14)	563.12	0.528E-21	P(14) Z	69	2116.808 32(14)	522.86	0.174E-21	R(3) Y
35	2109.869 87(9)*	26.78	0.411E-20	R(11) W	70	2116.817 89(14)	522.86	0.174E-21	R(3) Z

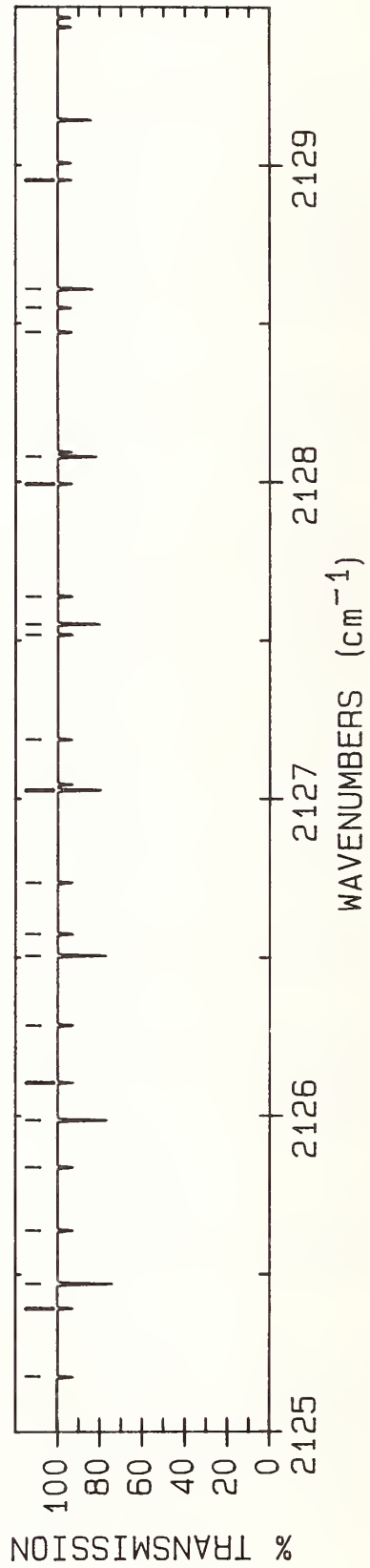
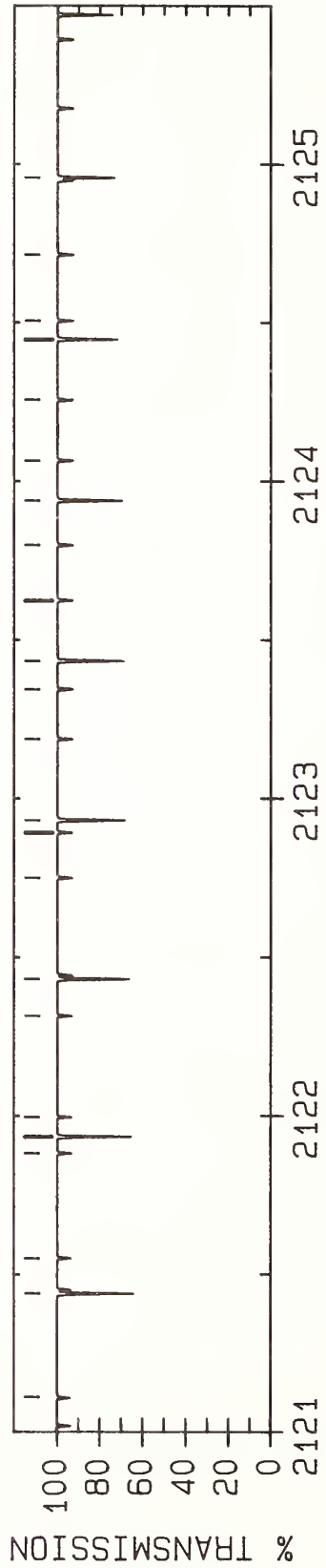
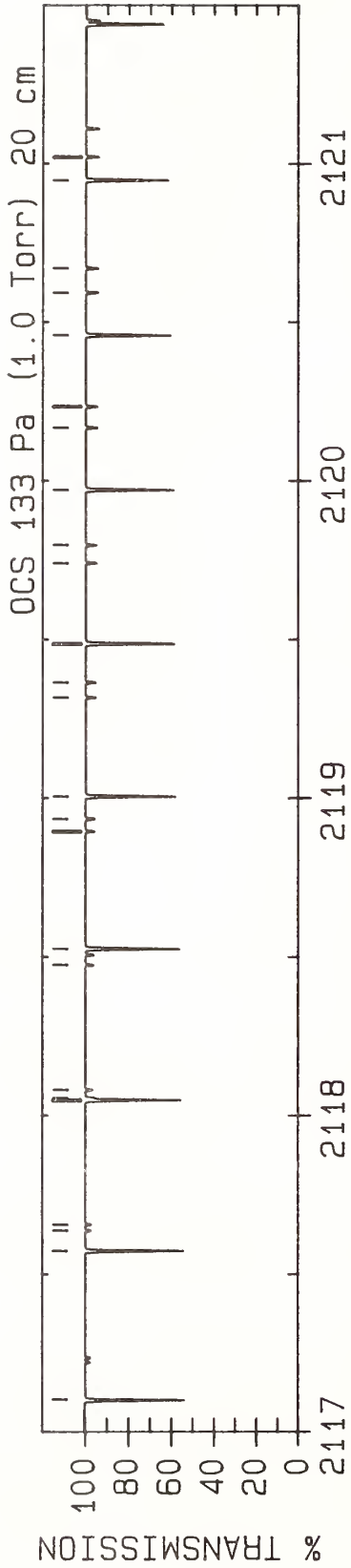

LINE #	WAVENUMBER(unc) (cm ⁻¹)	LOWER STATE (cm ⁻¹)	INTENSITY (cm/molecule)	ASSIGNMENT ROTATION BAND	LINE #	WAVENUMBER(unc) (cm ⁻¹)	LOWER STATE (cm ⁻¹)	INTENSITY (cm/molecule)	ASSIGNMENT ROTATION BAND	LINE #	WAVENUMBER(unc) (cm ⁻¹)	LOWER STATE (cm ⁻¹)	INTENSITY (cm/molecule)	ASSIGNMENT ROTATION BAND
1	2117.101 78(9)*	153.34	0.518E-20	R(27)	36	2122.931 31(9)*	316.35	0.333E-20	R(39)	36	2122.931 31(9)*	316.35	0.333E-20	R(39)
2	2117.573 83(9)*	164.69	0.508E-20	R(28)	37	2123.186 63(14)	589.88	0.635E-21	R(18)	37	2123.186 63(14)	589.88	0.635E-21	R(18)
3	2117.638 15(14)	526.51	0.266E-21	R(5)	38	2123.344 34(14)	589.95	0.635E-21	R(18)	38	2123.344 34(14)	589.95	0.635E-21	R(18)
4	2117.657 23(14)	526.52	0.266E-21	R(5)	39	2123.433 82(9)*	332.57	0.315E-20	R(40)	39	2123.433 82(9)*	332.57	0.315E-20	R(40)
5	2118.048 33(9)*	176.45	0.496E-20	R(29)	40	2123.624 60(14)	597.60	0.645E-21	R(19)	40	2123.624 60(14)	597.60	0.645E-21	R(19)
6	2118.055 44(14)	528.95	0.308E-21	R(6)	41	2123.798 48(14)	597.68	0.645E-21	R(19)	41	2123.798 48(14)	597.68	0.645E-21	R(19)
7	2118.080 45(14)	528.96	0.308E-21	R(6)	42	2123.938 99(9)*	349.19	0.297E-20	R(41)	42	2123.938 99(9)*	349.19	0.297E-20	R(41)
8	2118.474 31(14)	531.80	0.349E-21	R(7)	43	2124.064 17(14)	605.72	0.650E-21	R(20)	43	2124.064 17(14)	605.72	0.650E-21	R(20)
9	2118.525 28(9)*	188.62	0.483E-20	R(30)	44	2124.255 02(14)	605.81	0.650E-21	R(20)	44	2124.255 02(14)	605.81	0.650E-21	R(20)
10	2118.894 76(14)	535.04	0.388E-21	R(8)	45	2124.446 86(9)*	366.22	0.280E-20	R(42)	45	2124.446 86(9)*	366.22	0.280E-20	R(42)
11	2118.934 01(14)	535.06	0.388E-21	R(8)	46	2124.505 35(14)	614.25	0.655E-21	R(21)	46	2124.505 35(14)	614.25	0.655E-21	R(21)
12	2119.004 70(9)*	201.19	0.469E-20	R(31)	47	2124.713 95(14)	614.35	0.655E-21	R(21)	47	2124.713 95(14)	614.35	0.655E-21	R(21)
13	2119.316 80(14)	538.70	0.425E-21	R(9)	48	2124.957 42(9)*	383.65	0.263E-20	R(43)	48	2124.957 42(9)*	383.65	0.263E-20	R(43)
14	2119.364 35(14)	538.72	0.425E-21	R(9)	49	2125.175 28(14)	623.29	0.655E-21	R(22)	49	2125.175 28(14)	623.29	0.655E-21	R(22)
15	2119.486 62(9)*	214.17	0.454E-20	R(32)	50	2125.392 55(14)	632.52	0.655E-21	R(23)	50	2125.392 55(14)	632.52	0.655E-21	R(23)
16	2119.740 42(14)	542.76	0.459E-21	R(10)	51	2125.470 72(9)*	401.49	0.246E-20	R(44)	51	2125.470 72(9)*	401.49	0.246E-20	R(44)
17	2119.797 06(14)	542.79	0.459E-21	R(10)	52	2125.639 02(14)	632.64	0.655E-21	R(23)	52	2125.639 02(14)	632.64	0.655E-21	R(23)
18	2119.971 05(9)*	227.55	0.438E-20	R(33)	53	2125.838 58(14)	642.27	0.650E-21	R(24)	53	2125.838 58(14)	642.27	0.650E-21	R(24)
19	2120.165 63(14)	547.23	0.490E-21	R(11)	54	2125.986 77(9)*	419.73	0.230E-20	R(45)	54	2125.986 77(9)*	419.73	0.230E-20	R(45)
20	2120.232 14(14)	547.26	0.490E-21	R(11)	55	2126.105 17(14)	642.40	0.650E-21	R(24)	55	2126.105 17(14)	642.40	0.650E-21	R(24)
21	2120.458 00(9)*	241.34	0.421E-20	R(34)	56	2126.286 24(14)	652.42	0.645E-21	R(25)	56	2126.286 24(14)	652.42	0.645E-21	R(25)
22	2120.592 42(14)	552.11	0.520E-21	R(12)	57	2126.505 59(9)*	438.37	0.214E-20	R(46)	57	2126.505 59(9)*	438.37	0.214E-20	R(46)
23	2120.669 60(14)	552.14	0.520E-21	R(12)	58	2126.573 72(14)	652.56	0.645E-21	R(25)	58	2126.573 72(14)	652.56	0.645E-21	R(25)
24	2120.947 49(9)*	255.53	0.404E-20	R(35)	59	2126.735 53(14)	662.98	0.635E-21	R(26)	59	2126.735 53(14)	662.98	0.635E-21	R(26)
25	2121.020 81(14)	557.38	0.545E-21	R(13)	60	2127.027 20(9)*	457.42	0.199E-20	R(47)	60	2127.027 20(9)*	457.42	0.199E-20	R(47)
26	2121.109 44(14)	557.42	0.545E-21	R(13)	61	2127.186 46(14)	673.94	0.625E-21	R(27)	61	2127.186 46(14)	673.94	0.625E-21	R(27)
27	2121.439 55(9)*	270.13	0.387E-20	R(36)	62	2127.518 08(14)	674.10	0.625E-21	R(27)	62	2127.518 08(14)	674.10	0.625E-21	R(27)
28	2121.551 65(14)	563.12	0.570E-21	R(14)	63	2127.551 62(9)*	476.88	0.185E-20	R(48)	63	2127.551 62(9)*	476.88	0.185E-20	R(48)
29	2121.882 35(14)	569.16	0.590E-21	R(15)	64	2127.639 03(14)	685.31	0.610E-21	R(28)	64	2127.639 03(14)	685.31	0.610E-21	R(28)
30	2121.934 19(9)*	285.13	0.369E-20	R(37)	65	2127.993 90(14)	685.49	0.610E-21	R(28)	65	2127.993 90(14)	685.49	0.610E-21	R(28)
31	2121.996 25(14)	569.22	0.590E-21	R(15)	66	2128.078 89(9)*	496.74	0.171E-20	R(49)	66	2128.078 89(9)*	496.74	0.171E-20	R(49)
32	2122.315 51(14)	575.66	0.610E-21	R(16)	67	2128.472 14(14)	697.27	0.595E-21	R(29)	67	2128.472 14(14)	697.27	0.595E-21	R(29)
33	2122.431 44(9)*	300.54	0.351E-20	R(38)	68	2128.549 12(15)	709.27	0.580E-21	R(30)	68	2128.549 12(15)	709.27	0.580E-21	R(30)
34	2122.750 27(14)	582.57	0.625E-21	R(17)	69	2128.609 01(9)*	517.00	0.157E-20	R(50)	69	2128.609 01(9)*	517.00	0.157E-20	R(50)
35	2122.892 59(14)	582.63	0.625E-21	R(17)	70	2128.952 82(14)	709.47	0.580E-21	R(30)	70	2128.952 82(14)	709.47	0.580E-21	R(30)

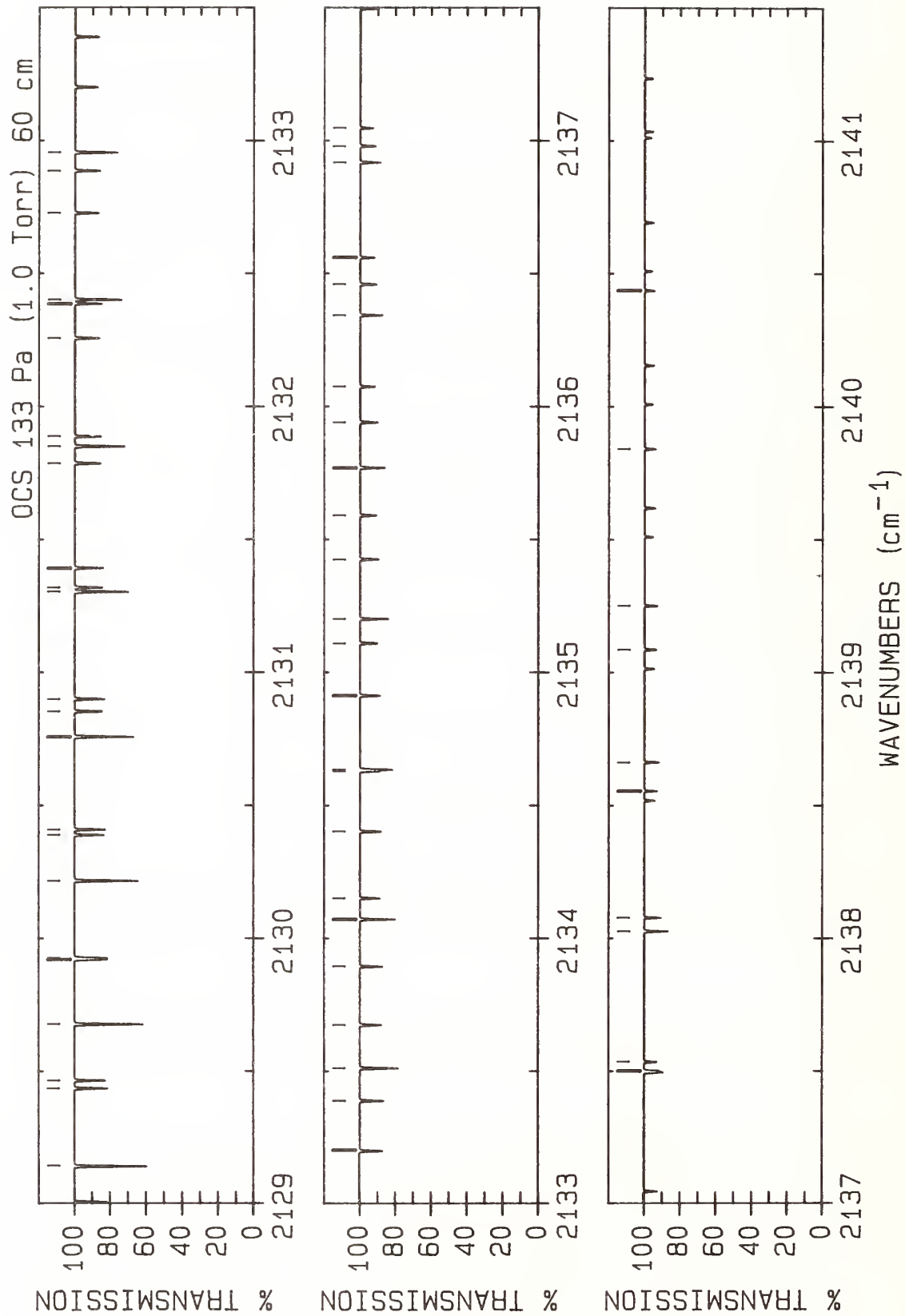

LINE #	WAVENUMBER(unc) (cm ⁻¹)	LOWER STATE (cm ⁻¹)	INTENSITY (cm/molecule)	ASSIGNMENT ROTATION BAND	LINE #	WAVENUMBER(unc) (cm ⁻¹)	LOWER STATE (cm ⁻¹)	INTENSITY (cm/molecule)	ASSIGNMENT ROTATION BAND
1	2129.142 02(9)*	537.67	0.145E-20	R(51) W	31	2134.151 26(17)	887.08	0.341E-21	R(42) Y
2	2129.435 94(14)	722.07	0.565E-21	R(31) Z	32	2134.402 39(17)	870.40	0.361E-21	R(41) Z
3	2129.465 85(15)	734.85	0.545E-21	R(32) Y	33	2134.629 36(18)	904.54	0.320E-21	R(43) Y
4	2129.677 92(9)*	558.74	0.133E-20	R(52) W	34	2134.635 00(10)*	766.58	0.551E-21	R(61) W
5	2129.921 49(14)	735.07	0.545E-21	R(32) Z	35	2134.912 70(18)	887.47	0.340E-21	R(42) Z
6	2129.926 72(15)	748.25	0.530E-21	R(33) Y	36	2135.109 23(19)	922.39	0.300E-21	R(44) Y
7	2130.216 75(9)*	580.22	0.122E-20	R(53) W	37	2135.201 01(11)*	791.70	0.494E-21	R(62) W
8	2130.389 27(15)	762.05	0.510E-21	R(34) Y	38	2135.425 51(19)	904.94	0.320E-21	R(43) Z
9	2130.409 50(14)	748.49	0.530E-21	R(33) Z	39	2135.590 89(20)	940.66	0.281E-21	R(45) Y
10	2130.758 52(9)*	602.10	0.111E-20	R(54) W	40	2135.770 14(11)*	817.21	0.441E-21	R(63) W
11	2130.853 51(15)	776.26	0.488E-21	R(35) Y	41	2135.940 84(20)	922.82	0.299E-21	R(44) Z
12	2130.899 96(14)	762.31	0.510E-21	R(34) Z	42	2136.074 36(22)	959.33	0.261E-21	R(46) Y
13	2131.303 26(9)*	624.39	0.101E-20	R(55) W	43	2136.342 38(12)*	843.13	0.393E-21	R(64) W
14	2131.319 45(15)	790.88	0.467E-21	R(36) Y	44	2136.458 69(22)	941.10	0.281E-21	R(45) Z
15	2131.392 89(14)	776.53	0.488E-21	R(35) Z	45	2136.559 64(23)	978.40	0.244E-21	R(47) Y
16	2131.787 10(15)	805.90	0.447E-21	R(37) Y	46	2136.917 76(13)*	869.46	0.350E-21	R(65) W
17	2131.850 98(9)*	647.08	0.921E-21	R(56) W	47	2136.979 07(23)	959.78	0.261E-21	R(46) Z
18	2131.888 27(15)	791.16	0.467E-21	R(36) Z	48	2137.046 76(25)	997.88	0.226E-21	R(48) Y
19	2132.256 46(15)	821.33	0.425E-21	R(38) Y	49	2137.496 29(14)*	896.18	0.311E-21	R(66) W
20	2132.386 13(15)	806.20	0.446E-21	R(37) Z	50	2137.501 98(26)	978.88	0.244E-21	R(47) Z
21	2132.401 70(9)*	670.17	0.835E-21	R(57) W	51	2137.535 73(27)	1017.76	0.209E-21	R(49) Y
22	2132.727 55(16)	837.16	0.404E-21	R(39) Y	52	2138.026 55(30)	1038.05	0.193E-21	R(50) Y
23	2132.886 47(15)	821.64	0.425E-21	R(38) Z	53	2138.027 44(28)	998.38	0.226E-21	R(48) Z
24	2132.955 45(10)*	693.67	0.755E-21	R(58) W	54	2138.077 98(15)*	923.31	0.275E-21	R(67) W
25	2133.200 37(16)	853.39	0.382E-21	R(40) Y	55	2138.555 44(31)	1018.28	0.209E-21	R(49) Z
26	2133.389 28(15)	837.49	0.403E-21	R(39) Z	56	2138.662 84(17)*	950.85	0.243E-21	R(68) W
27	2133.512 23(10)*	717.57	0.681E-21	R(59) W	57	2139.086 01(34)	1038.59	0.193E-21	R(50) Z
28	2133.674 94(16)	870.04	0.361E-21	R(41) Y	58	2139.250 89(19)	978.78	0.214E-21	R(69) W
29	2133.894 59(16)	853.74	0.382E-21	R(40) Z	59	2139.842 13(21)	1007.13	0.188E-21	R(70) W
30	2134.072 08(10)*	741.87	0.613E-21	R(60) W	60	2140.436 57(24)	1035.87	0.165E-21	R(71) W

ATLAS OF OCS ABSORPTION LINES FROM 2510 cm⁻¹ to 2600 cm⁻¹

key:

Band	Isotopomer	Vibrational Transition
A	¹⁶ O ¹² C ³² S	00 ⁰ 3-00 ⁰ 0
B		01 ¹ 3-01 ^{1e} 0
C		01 ¹ 3-01 ^{1f} 0
D		00 ⁰ 4-00 ⁰ 1
E		02 ² 3-02 ^{2e} 0
F		02 ² 3-02 ^{2f} 0
G		02 ⁰ 3-02 ⁰ 0
W		11 ¹ 0-00 ⁰ 0
X		12 ⁰ 0-01 ¹ 0
Y		12 ² 0-01 ^{1e} 0
Z		12 ² 0-01 ^{1f} 0
L	¹⁶ O ¹² C ³³ S	11 ¹ 0-00 ⁰ 0
P	¹⁶ O ¹² C ³⁴ S	00 ⁰ 3-00 ⁰ 0
Q		11 ¹ 0-00 ⁰ 0
T	¹⁶ O ¹³ C ³² S	00 ⁰ 3-00 ⁰ 0
U		11 ¹ 0-00 ⁰ 0

If the e or f designation is not specified (for $l \neq 0$), then the transition is to either level, depending on the selection rules and the change in the rotational quantum number, J . Spectra are given for a slitwidth of 0.003 cm⁻¹, a temperature of 296 K. Except for the B and C bands for which the transition moment used was 0.00284 debye, the transition moment used for the $\Delta v_3=3$ transitions was 0.00367 debye and that used for the $\Delta v_1=1, \Delta v_2=1$ transitions was 0.00257 debye. No Herman-Wallis constant was included in the intensity calculation for the $\Delta v_3=3$ bands but the Herman-Wallis correction of $C_1=0.00463$ was used for the $\Delta v_1=1, \Delta v_2=1$ bands as recommended by Dang-Nhu and Guelachvili [5.104].

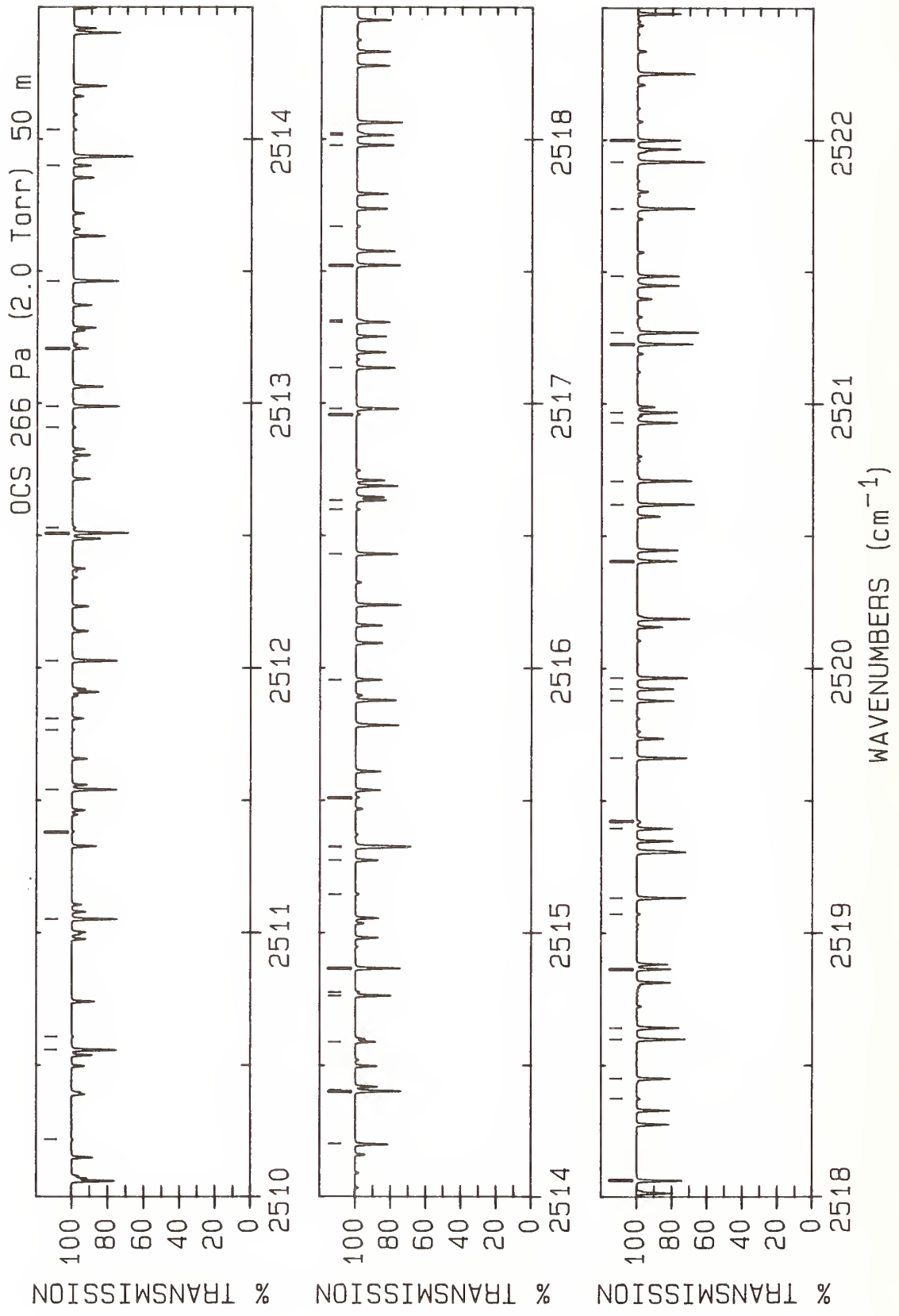

LINE #	WAVENUMBER(unc) (cm ⁻¹)	LOWER STATE (cm ⁻¹)	INTENSITY (cm/molecule)	ASSIGNMENT ROTATION BAND	LINE #	WAVENUMBER(unc) (cm ⁻¹)	LOWER STATE (cm ⁻¹)	INTENSITY (cm/molecule)	ASSIGNMENT ROTATION BAND
1	2510.217 53(14)*	8.49	0.240E-24	R(6) U	36	2516.978 71(48)	1158.61	0.591E-23	P(38) D
2	2510.558 56(56)	160.67	0.601E-23	P(28) P	37	2517.133 89(49)	41.56	0.537E-23	P(14) P
3	2510.607 47(14)*	11.32	0.268E-24	R(7) U	38	2517.307 19(17)*	1065.02	0.442E-23	P(72) A
4	2511.051 65(55)	149.59	0.611E-23	P(27) P	39	2517.314 83(16)*	131.41	0.525E-24	R(25) U
5	2511.381 91(14)*	18.20	0.323E-24	R(9) U	40	2517.522 92(45)	1143.24	0.620E-23	P(37) D
6	2511.541 14(53)	138.90	0.620E-23	P(26) P	41	2517.670 05(16)*	141.93	0.522E-24	R(26) U
7	2511.766 41(14)*	22.24	0.348E-24	R(10) U	42	2517.977 20(16)*	1035.87	0.503E-23	P(71) A
8	2511.810 08(37)	1312.69	0.147E-23	P(80) A	43	2518.015 59(56)	30.87	0.485E-23	P(12) P
9	2512.027 02(51)	128.62	0.627E-23	P(25) P	44	2518.023 42(17)*	152.84	0.517E-24	R(27) U
10	2512.509 29(49)	118.72	0.632E-23	P(24) P	45	2518.063 34(44)	1128.29	0.649E-23	P(36) D
11	2512.510 58(33)*	1280.32	0.170E-23	P(79) A	46	2518.374 95(17)*	164.16	0.510E-24	R(28) U
12	2512.529 94(14)*	31.54	0.395E-24	R(12) U	47	2518.451 03(59)	26.12	0.455E-23	P(11) P
13	2512.908 98(14)*	36.80	0.417E-24	R(13) U	48	2518.599 96(44)	1113.73	0.677E-23	P(35) D
14	2512.987 97(47)	109.23	0.634E-23	P(23) P	49	2518.643 41(15)*	1007.13	0.570E-23	P(70) A
15	2513.207 25(30)*	1248.35	0.196E-23	P(78) A	50	2518.865 01(53)	821.64	0.457E-23	P(38) C
16	2513.463 03(45)	100.13	0.634E-23	P(22) P	51	2519.072 47(19)*	188.01	0.493E-24	R(30) U
17	2513.900 11(27)*	1216.79	0.226E-23	P(77) A	52	2519.132 80(44)	1099.58	0.705E-23	P(34) D
18	2514.035 15(14)*	55.00	0.470E-24	R(16) U	53	2519.395 71(51)	806.20	0.480E-23	P(37) C
19	2514.200 68(87)	1241.47	0.446E-23	P(43) D	54	2519.418 45(19)*	200.54	0.482E-24	R(31) U
20	2514.402 36(42)	83.11	0.626E-23	P(20) P	55	2519.424 04(94)	1051.11	0.330E-24	R(4) G
21	2514.406 89(14)*	61.87	0.484E-24	R(17) U	56	2519.661 85(44)	1085.84	0.731E-23	P(33) D
22	2514.589 14(24)*	1185.63	0.259E-23	P(76) A	57	2519.878 82(49)	790.88	0.503E-23	P(36) B
23	2514.763 89(75)	1224.09	0.474E-23	P(42) D	58	2519.923 03(49)	791.16	0.502E-23	P(36) C
24	2514.776 80(14)*	69.15	0.496E-24	R(18) U	59	2519.964 46(15)*	950.85	0.728E-23	P(68) A
25	2514.866 62(41)	75.19	0.619E-23	P(19) P	60	2520.405 63(47)	776.26	0.525E-23	P(35) B
26	2515.144 88(14)*	76.83	0.506E-24	R(19) U	61	2520.619 31(14)*	923.31	0.820E-23	P(67) A
27	2515.274 37(22)*	1154.87	0.297E-23	P(75) A	62	2520.708 59(43)	1059.56	0.781E-23	P(31) D
28	2515.323 29(65)	1207.11	0.503E-23	P(41) D	63	2520.928 98(47)	762.05	0.547E-23	P(34) B
29	2515.327 28(41)	67.68	0.608E-23	P(18) P	64	2520.967 55(48)	762.31	0.546E-23	P(34) C
30	2515.511 13(14)*	84.92	0.514E-24	R(20) U	65	2521.226 29(43)	1047.02	0.803E-23	P(30) D
31	2515.955 78(20)*	1124.52	0.340E-23	P(74) A	66	2521.270 37(14)*	896.18	0.922E-23	P(66) A
32	2516.430 70(51)	1174.37	0.561E-23	P(39) D	67	2521.484 75(48)	748.49	0.567E-23	P(33) C
33	2516.598 86(15)*	111.60	0.527E-24	R(23) U	68	2521.740 20(42)	1034.89	0.824E-23	P(29) D
34	2516.633 39(18)*	1094.57	0.388E-23	P(73) A	69	2521.917 65(14)*	869.46	0.103E-22	P(65) A
35	2516.957 77(15)*	121.31	0.527E-24	R(24) U	70	2521.998 59(48)	735.07	0.587E-23	P(32) C

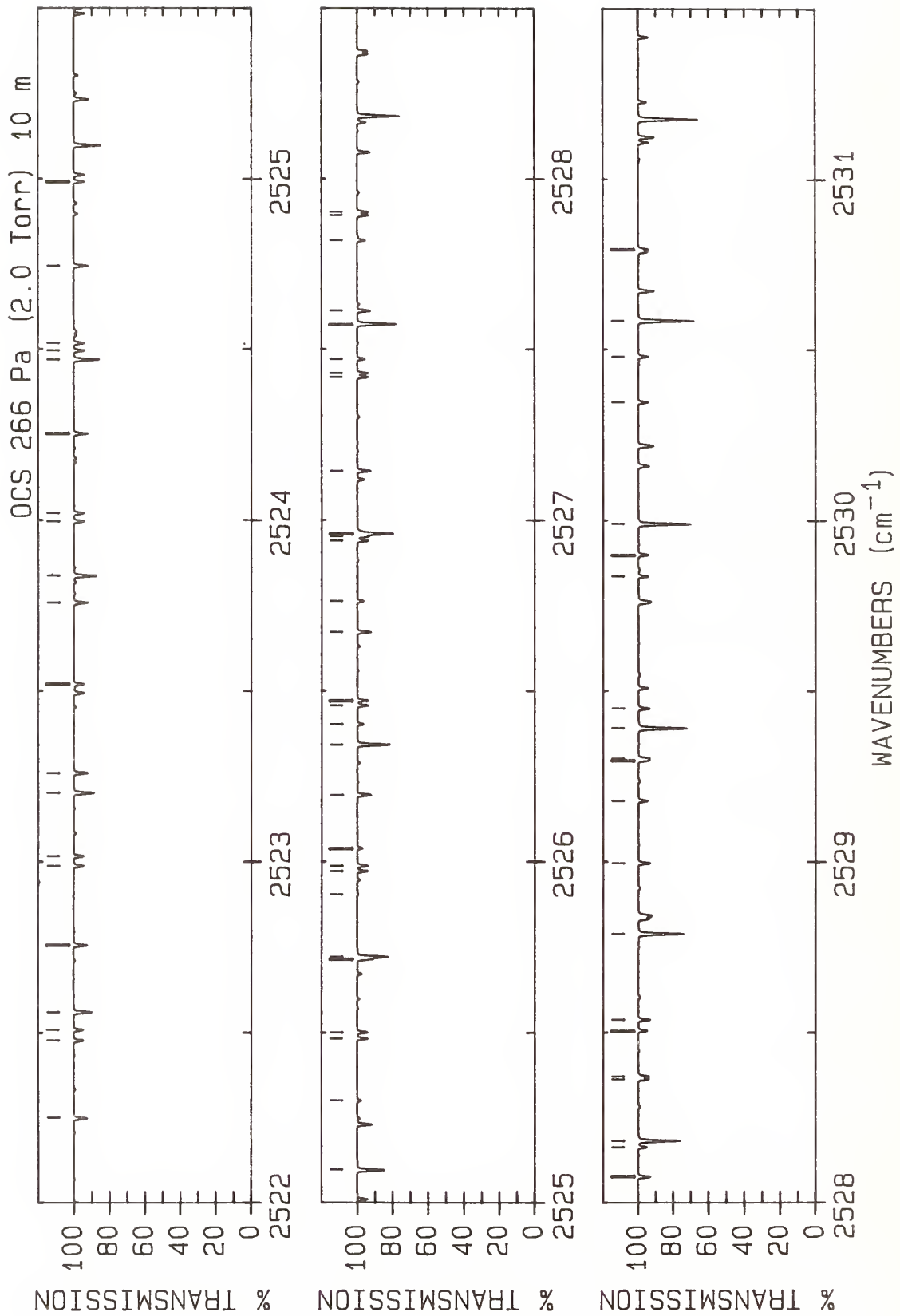

LINE #	WAVENUMBER(unc) (cm ⁻¹)	LOWER STATE (cm ⁻¹)	INTENSITY (cm/molecule)	ASSIGNMENT ROTATION BAND	LINE #	WAVENUMBER(unc) (cm ⁻¹)	LOWER STATE (cm ⁻¹)	INTENSITY (cm/molecule)	ASSIGNMENT ROTATION BAND
1	2522.250 33(41)	1023.17	0.842E-23	P(28) D	36	2526.671 60(32)	935.82	0.875E-23	P(19) D
2	2522.478 25(47)	721.86	0.606E-23	P(31) B	37	2526.762 37(59)	17.81	0.432E-23	R(9) P
3	2522.509 06(48)	722.07	0.606E-23	P(31) C	38	2526.939 57(39)	623.18	0.695E-23	P(22) B
4	2522.561 15(14)*	843.13	0.116E-22	P(64) A	39	2526.952 10(39)	623.29	0.695E-23	P(22) C
5	2522.756 69(40)	1011.84	0.858E-23	P(27) D	40	2526.960 20(13)*	670.17	0.239E-22	P(57) A
6	2522.987 76(47)	709.27	0.624E-23	P(30) B	41	2527.143 98(33)	928.13	0.861E-23	P(18) D
7	2523.016 16(47)	709.47	0.623E-23	P(30) C	42	2527.418 03(37)	614.25	0.693E-23	P(21) B
8	2523.200 89(14)*	817.21	0.129E-22	P(63) A	43	2527.429 01(38)	614.35	0.693E-23	P(21) C
9	2523.259 26(38)	1000.93	0.872E-23	P(26) D	44	2527.470 79(52)	26.12	0.498E-23	R(11) P
10	2523.519 91(47)	697.27	0.639E-23	P(29) C	45	2527.573 60(13)*	647.08	0.263E-22	P(56) A
11	2523.758 06(37)	990.41	0.882E-23	P(25) D	46	2527.612 60(34)	920.85	0.842E-23	P(17) D
12	2523.836 85(14)*	791.70	0.144E-22	P(62) A	47	2527.819 57(49)	30.87	0.528E-23	R(12) P
13	2523.996 41(46)	685.31	0.654E-23	P(28) B	48	2527.893 05(36)	605.72	0.688E-23	P(20) B
14	2524.020 29(46)	685.49	0.654E-23	P(28) C	49	2527.902 56(37)	605.81	0.688E-23	P(20) C
15	2524.253 08(35)	980.30	0.890E-23	P(24) D	50	2528.077 45(36)	913.98	0.820E-23	P(16) D
16	2524.469 04(13)*	766.58	0.160E-22	P(61) A	51	2528.164 71(46)	36.02	0.554E-23	R(13) P
17	2524.495 56(45)	673.94	0.667E-23	P(27) B	52	2528.183 25(13)*	624.39	0.289E-22	P(55) A
18	2524.517 31(45)	674.10	0.666E-23	P(27) C	53	2528.364 63(36)	597.60	0.680E-23	P(19) B
19	2524.744 33(34)	970.60	0.894E-23	P(23) D	54	2528.372 76(36)	597.68	0.680E-23	P(19) C
20	2524.991 26(44)	662.98	0.677E-23	P(26) B	55	2528.506 23(44)	41.56	0.578E-23	R(14) P
21	2525.097 47(13)*	741.87	0.178E-22	P(60) A	56	2528.538 52(38)	907.50	0.793E-23	P(15) D
22	2525.302 05(73)	5.94	0.275E-23	R(5) P	57	2528.789 16(13)*	602.10	0.316E-22	P(54) A
23	2525.483 50(43)	652.42	0.685E-23	P(25) B	58	2528.995 83(40)	901.44	0.763E-23	P(14) D
24	2525.501 29(43)	652.56	0.685E-23	P(25) C	59	2529.178 36(41)	53.83	0.617E-23	R(16) P
25	2525.715 51(32)	952.40	0.892E-23	P(21) D	60	2529.297 46(35)	582.57	0.654E-23	P(17) B
26	2525.722 14(13)*	717.57	0.197E-22	P(59) A	61	2529.303 13(36)	582.63	0.654E-23	P(17) C
27	2525.903 70(58)	1149.99	0.941E-24	R(22) G	62	2529.391 31(13)*	580.22	0.345E-22	P(53) A
28	2525.972 30(41)	642.27	0.691E-23	P(24) B	63	2529.449 36(42)	895.77	0.728E-23	P(13) D
29	2525.988 25(41)	642.40	0.691E-23	P(24) C	64	2529.835 95(42)	67.68	0.645E-23	R(18) P
30	2526.039 45(67)	11.08	0.357E-23	R(7) P	65	2529.899 13(45)	890.52	0.690E-23	P(12) D
31	2526.195 44(32)	943.90	0.886E-23	P(20) D	66	2529.989 73(13)*	558.74	0.376E-22	P(52) A
32	2526.343 05(13)*	693.67	0.217E-22	P(58) A	67	2530.345 13(47)	885.66	0.648E-23	P(11) D
33	2526.402 72(63)	14.25	0.396E-23	R(8) P	68	2530.478 97(45)	83.11	0.662E-23	R(20) P
34	2526.457 66(40)	632.52	0.695E-23	P(23) B	69	2530.584 40(13)*	537.67	0.409E-22	P(51) A
35	2526.471 85(40)	632.64	0.694E-23	P(23) C	70	2530.795 01(47)	91.42	0.666E-23	R(21) P

OCS 266 Pa (2.0 Torr) 15 m

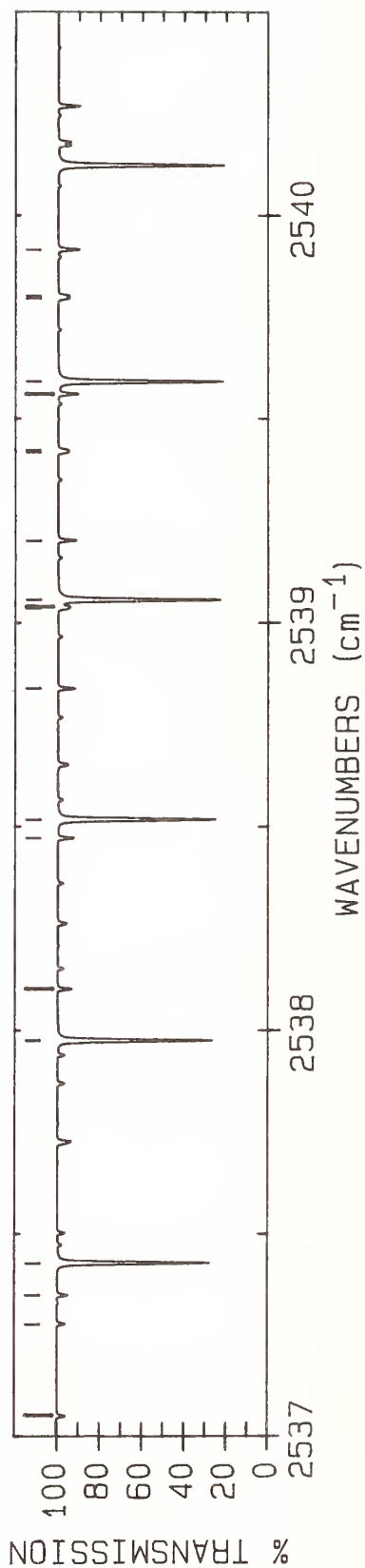
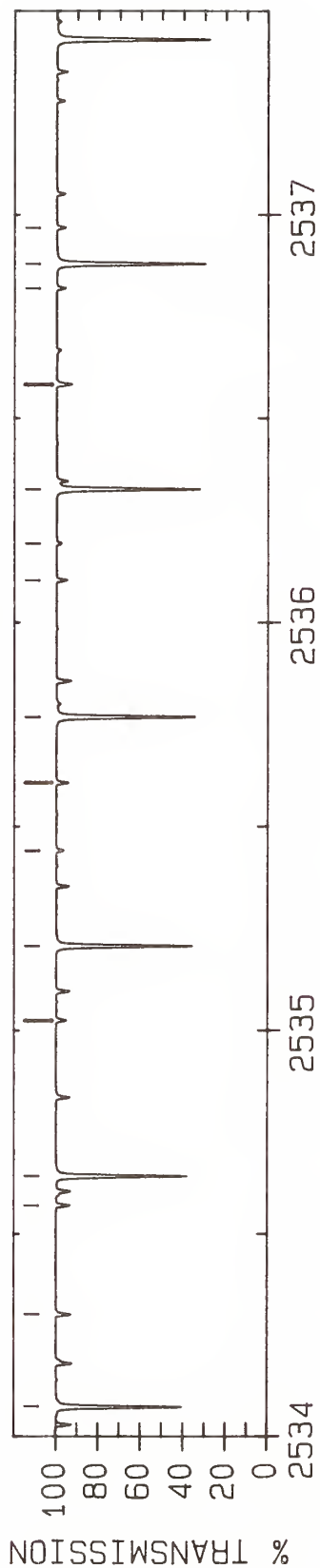
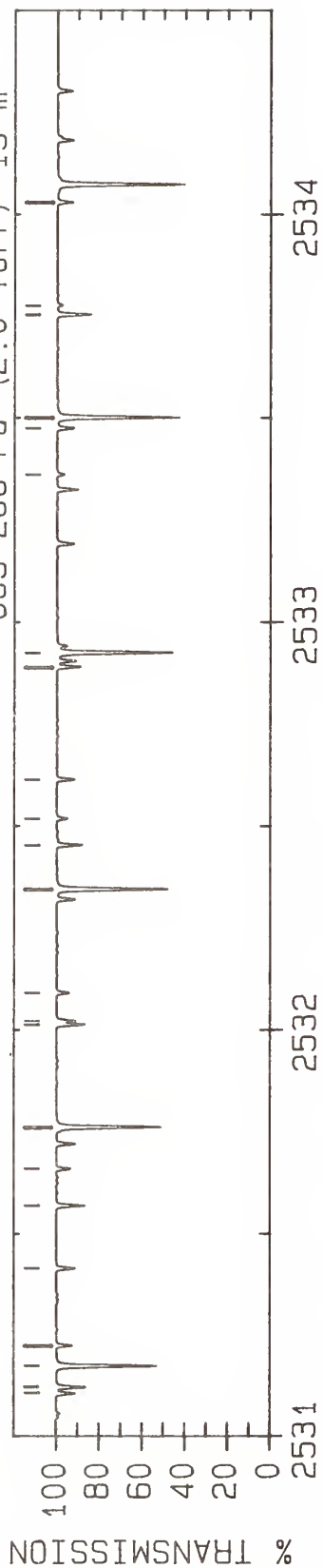

LINE #	WAVENUMBER(unc) (cm ⁻¹)	LOWER STATE (cm ⁻¹)	INTENSITY (cm/molecule)	ASSIGNMENT ROTATION BAND	LINE #	WAVENUMBER(unc) (cm ⁻¹)	LOWER STATE (cm ⁻¹)	INTENSITY (cm/molecule)	ASSIGNMENT ROTATION BAND
1	2531.107 40(49)	100.13	0.668E-23	R(22) P	36	2535.025 49(52)	524.48	0.192E-23	P(4) B
2	2531.121 84(39)	557.38	0.565E-23	P(13) B	37	2535.207 40(12)*	383.65	0.730E-22	P(43) A
3	2531.123 72(40)	557.42	0.564E-23	P(13) C	38	2535.441 04(53)	522.86	0.138E-23	P(3) C
4	2531.175 33(13)*	517.00	0.443E-22	P(50) A	39	2535.442 03(53)	522.86	0.138E-23	P(3) B
5	2531.225 81(52)	877.17	0.552E-23	P(9) D	40	2535.607 3	293.19	0.444E-23	R(38) P
6	2531.416 15(51)	109.23	0.667E-23	R(23) P	41	2535.768 52(12)*	366.22	0.776E-22	P(42) A
7	2531.569 34(40)	552.11	0.534E-23	P(12) B	42	2536.103 4	324.44	0.401E-23	R(40) P
8	2531.570 50(41)	552.14	0.534E-23	P(12) C	43	2536.193 04(60)	860.18	0.200E-23	R(2) D
9	2531.660 50(54)	873.53	0.500E-23	P(8) D	44	2536.325 91(12)*	349.19	0.823E-22	P(41) A
10	2531.762 53(13)*	496.74	0.479E-22	P(49) A	45	2536.582 43(59)	861.39	0.266E-23	R(3) D
11	2532.013 39(42)	547.23	0.501E-23	P(11) B	46	2536.584 7	357.27	0.358E-23	R(42) P
12	2532.013 94(43)	547.26	0.501E-23	P(11) C	47	2536.819 8	374.27	0.338E-23	R(43) P
13	2532.022 67(55)	128.62	0.657E-23	R(25) P	48	2536.879 58(12)*	332.57	0.871E-22	P(40) A
14	2532.091 41(56)	870.29	0.444E-23	P(7) D	49	2536.968 04(57)	863.01	0.330E-23	R(4) D
15	2532.346 00(12)*	476.88	0.517E-22	P(48) A	50	2537.051 2	391.68	0.317E-23	R(44) P
16	2532.454 01(44)	542.76	0.465E-23	P(10) B	51	2537.278 8	409.47	0.297E-23	R(45) P
17	2532.454 04(45)	542.79	0.465E-23	P(10) C	52	2537.349 86(56)	865.03	0.392E-23	R(5) D
18	2532.518 56(57)	867.46	0.386E-23	P(6) D	53	2537.429 54(12)*	316.35	0.919E-22	P(39) A
19	2532.614 56(57)	149.59	0.639E-23	R(27) P	54	2537.975 79(12)*	300.54	0.967E-22	P(38) A
20	2532.890 79(46)	538.72	0.426E-23	P(9) C	55	2538.102 15(52)	870.29	0.509E-23	R(7) D
21	2532.891 19(45)	538.70	0.426E-23	P(9) B	56	2538.472 62(50)	873.53	0.564E-23	R(8) D
22	2532.925 73(12)*	457.42	0.557E-22	P(47) A	57	2538.518 32(12)*	285.13	0.102E-21	P(37) A
23	2533.361 53(60)	863.01	0.263E-23	P(4) D	58	2538.839 29(47)	877.17	0.616E-23	R(9) D
24	2533.474 90(62)	184.01	0.599E-23	R(30) P	59	2539.035 83(49)	526.51	0.297E-23	R(5) B
25	2533.501 74(12)*	438.37	0.598E-22	P(46) A	60	2539.040 37(49)	526.52	0.297E-23	R(5) C
26	2533.754 25(49)	531.81	0.339E-23	P(7) C	61	2539.057 14(12)*	270.13	0.106E-21	P(36) A
27	2533.754 34(65)	196.27	0.583E-23	R(31) P	62	2539.202 17(45)	881.21	0.664E-23	R(10) D
28	2533.755 23(49)	531.80	0.340E-23	P(7) B	63	2539.417 90(47)	528.95	0.345E-23	R(6) B
29	2533.777 36(61)	861.39	0.199E-23	P(3) D	64	2539.423 52(48)	528.96	0.345E-23	R(6) C
30	2534.030 10(70)	208.93	0.565E-23	R(32) P	65	2539.561 26(42)	885.66	0.709E-23	R(11) D
31	2534.074 02(12)*	419.73	0.641E-22	P(45) A	66	2539.592 26(12)*	255.53	0.111E-21	P(35) A
32	2534.302 18(78)	221.99	0.546E-23	R(33) P	67	2539.796 50(45)	531.80	0.391E-23	R(7) B
33	2534.570 57(89)	235.44	0.527E-23	R(34) P	68	2539.803 31(46)	531.81	0.391E-23	R(7) C
34	2534.642 57(12)*	401.49	0.685E-22	P(44) A	69	2539.916 55(40)	890.52	0.750E-23	R(12) D
35	2535.024 36(52)	524.49	0.192E-23	P(4) C					

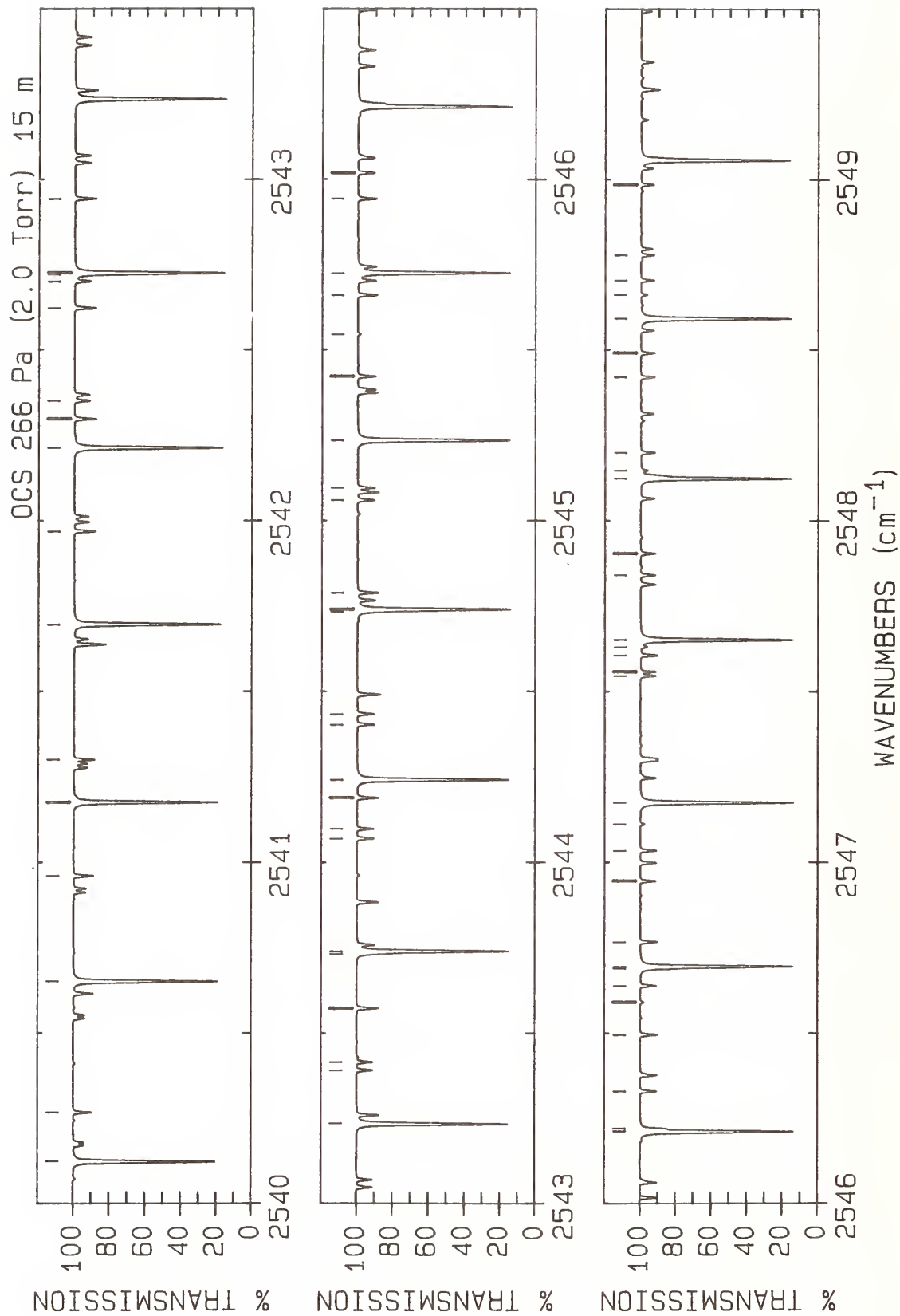

LINE #	WAVENUMBER(unc) (cm ⁻¹)	LOWER STATE (cm ⁻¹)	INTENSITY (cm/molecule)	ASSIGNMENT ROTATION BAND	LINE #	WAVENUMBER(unc) (cm ⁻¹)	LOWER STATE (cm ⁻¹)	INTENSITY (cm/molecule)	ASSIGNMENT ROTATION BAND
1	2540.123 66(12)*	241.34	0.115E-21	P(34) A	36	2545.544 62(18)*	843.13	0.140E-23	P(64) W
2	2540.268 04(38)	895.77	0.788E-23	R(13) D	37	2545.659 75(44)	1047.02	0.838E-23	R(30) D
3	2540.651 36(12)*	227.55	0.120E-21	P(33) A	38	2545.724 77(12)*	111.96	0.147E-21	P(23) A
4	2540.959 62(34)	907.50	0.851E-23	R(15) D	39	2545.942 40(44)	1059.56	0.814E-23	R(31) D
5	2541.175 36(12)*	214.17	0.124E-21	P(32) A	40	2546.018 00(45)	652.42	0.719E-23	R(25) B
6	2541.299 71(33)	913.98	0.876E-23	R(16) D	41	2546.211 78(12)*	102.63	0.147E-21	P(22) A
7	2541.695 65(12)*	201.19	0.128E-21	P(31) A	42	2546.221 20(44)	1072.49	0.788E-23	R(32) D
8	2541.968 45(32)	928.13	0.914E-23	R(18) D	43	2546.330 50(46)	662.98	0.709E-23	R(26) B
9	2542.212 24(12)*	188.62	0.132E-21	P(30) A	44	2546.496 14(44)	1085.84	0.761E-23	R(33) D
10	2542.297 10(32)	935.82	0.927E-23	R(19) D	45	2546.591 03(18)*	791.70	0.178E-23	P(62) W
11	2542.349 83(36)	563.07	0.637E-23	R(14) B	46	2546.639 48(46)	673.94	0.698E-23	R(27) B
12	2542.621 93(33)	943.90	0.936E-23	R(20) D	47	2546.689 74(47)	674.10	0.697E-23	R(27) C
13	2542.700 72(35)	569.16	0.660E-23	R(15) B	48	2546.695 08(12)*	93.71	0.147E-21	P(21) A
14	2542.720 40(36)	569.22	0.660E-23	R(15) C	49	2546.767 22(44)	1099.58	0.733E-23	R(34) D
15	2542.725 12(12)*	176.45	0.135E-21	P(29) A	50	2546.944 96(47)	685.31	0.684E-23	R(28) B
16	2542.942 95(34)	952.40	0.941E-23	R(21) D	51	2547.034 43(45)	1113.73	0.704E-23	R(35) D
17	2543.234 31(12)*	164.69	0.138E-21	P(28) A	52	2547.111 42(18)*	766.58	0.201E-23	P(61) W
18	2543.392 07(36)	582.57	0.697E-23	R(17) B	53	2547.174 70(12)*	85.19	0.145E-21	P(20) A
19	2543.415 91(36)	582.63	0.697E-23	R(17) C	54	2547.545 35(47)	709.27	0.651E-23	R(30) B
20	2543.573 52(37)	970.60	0.940E-23	R(23) D	55	2547.557 23(51)	1143.24	0.644E-23	R(37) D
21	2543.732 53(36)	589.88	0.710E-23	R(18) B	56	2547.605 35(48)	709.47	0.650E-23	R(30) C
22	2543.739 80(12)*	153.34	0.141E-21	P(27) A	57	2547.629 95(18)*	741.87	0.226E-23	P(60) W
23	2544.069 50(37)	597.60	0.720E-23	R(19) B	58	2547.650 62(12)*	77.08	0.144E-21	P(19) A
24	2544.097 87(38)	597.68	0.720E-23	R(19) C	59	2547.840 26(47)	721.86	0.632E-23	R(31) B
25	2544.188 77(40)	990.41	0.925E-23	R(25) D	60	2547.903 69(48)	722.07	0.631E-23	R(31) C
26	2544.241 59(12)*	142.38	0.143E-21	P(26) A	61	2548.122 84(12)*	69.37	0.141E-21	P(18) A
27	2544.402 99(39)	605.72	0.727E-23	R(20) B	62	2548.146 60(18)*	717.57	0.253E-23	P(59) W
28	2544.433 76(39)	605.81	0.727E-23	R(20) C	63	2548.198 60(48)	735.07	0.611E-23	R(32) C
29	2544.732 98(40)	614.25	0.731E-23	R(21) B	64	2548.419 48(47)	748.25	0.591E-23	R(33) B
30	2544.739 68(12)*	131.84	0.145E-21	P(25) A	65	2548.490 06(48)	748.49	0.590E-23	R(33) C
31	2544.788 69(42)	1011.84	0.898E-23	R(27) D	66	2548.591 37(12)*	62.07	0.138E-21	P(17) A
32	2545.059 48(41)	623.18	0.732E-23	R(22) B	67	2548.661 38(18)*	693.67	0.283E-23	P(58) W
33	2545.095 36(41)	623.29	0.732E-23	R(22) C	68	2548.703 79(49)	762.05	0.569E-23	R(34) B
34	2545.234 07(12)*	121.70	0.146E-21	P(24) A	69	2548.778 08(49)	762.31	0.568E-23	R(34) C
35	2545.421 05(43)	632.64	0.730E-23	R(23) C	70	2548.984 55(52)	776.26	0.546E-23	R(35) B

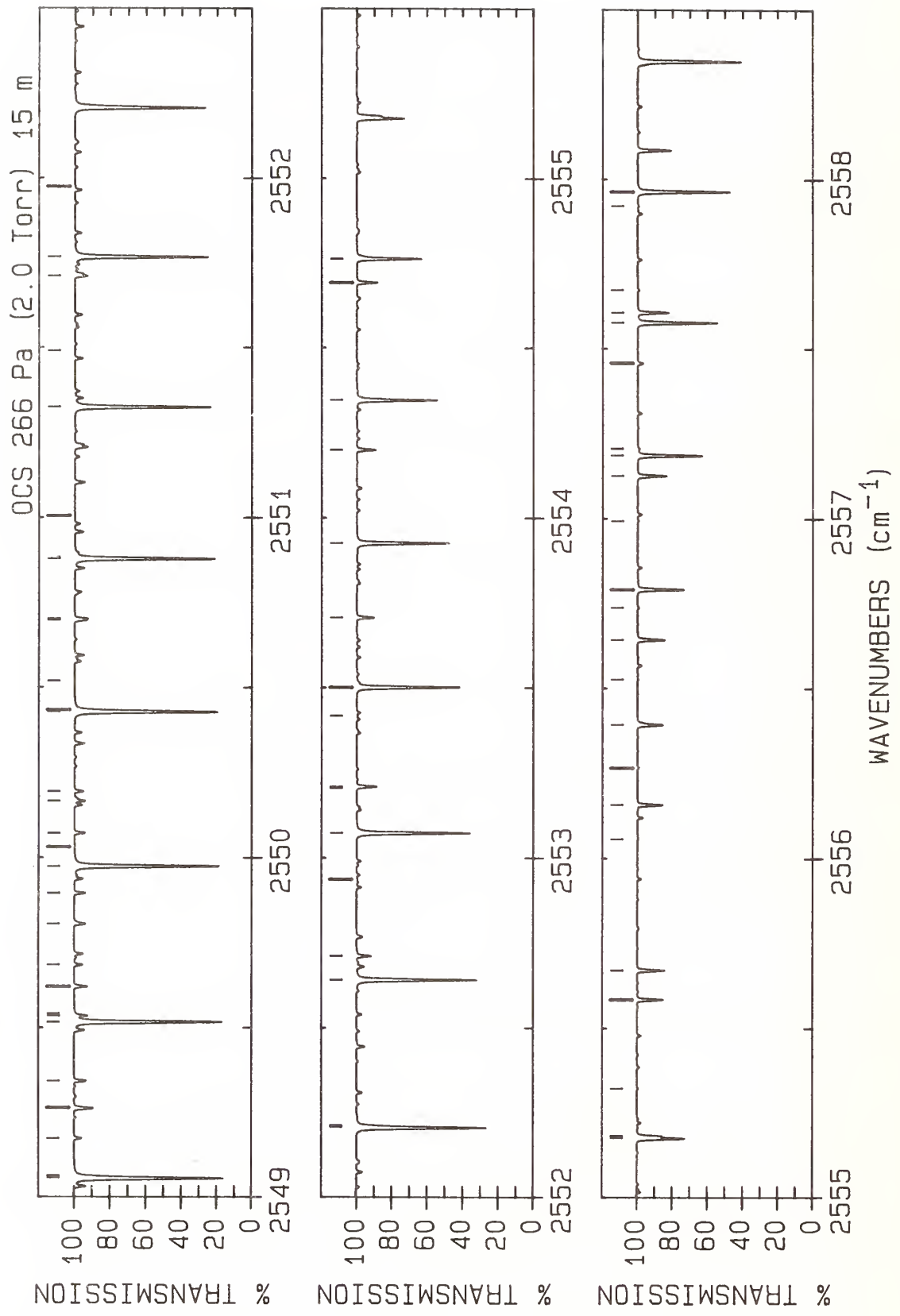

LINE #	WAVENUMBER(unc) (cm ⁻¹)	LOWER STATE (cm ⁻¹)	INTENSITY (cm/molecule)	ASSIGNMENT ROTATION BAND	LINE #	WAVENUMBER(unc) (cm ⁻¹)	LOWER STATE (cm ⁻¹)	INTENSITY (cm/molecule)	ASSIGNMENT ROTATION BAND
1	2549.056 21(12)*	55.17	0.135E-21	P(16) A	36	2553.073 56(13)*	11.36	0.731E-22	P(7) A
2	2549.062 65(51)	776.53	0.545E-23	R(35) C	37	2553.205 71(37)	446.25	0.376E-24	P(47) Q
3	2549.174 29(18)*	670.17	0.315E-23	P(57) W	38	2553.210 12(18)*	496.74	0.694E-23	P(49) W
4	2549.261 77(57)	790.88	0.523E-23	R(36) B	39	2553.417 62(40)	1017.76	0.491E-24	P(49) X
5	2549.264 6	1259.25	0.434E-23	R(44) D	40	2553.501 46(13)*	8.52	0.635E-22	P(6) A
6	2549.343 76(53)	791.16	0.522E-23	R(36) C	41	2553.706 17(18)*	476.88	0.757E-23	P(48) W
7	2549.517 36(12)*	48.68	0.130E-21	P(15) A	42	2553.925 66(13)*	6.09	0.536E-22	P(5) A
8	2549.535 44(64)	805.90	0.499E-23	R(37) B	43	2554.200 34(18)*	457.42	0.825E-23	P(47) W
9	2549.541 95(42)	1191.40	0.208E-24	P(57) X	44	2554.346 17(13)*	4.06	0.433E-22	P(4) A
10	2549.621 42(58)	806.20	0.499E-23	R(37) C	45	2554.692 64(18)*	438.37	0.896E-23	P(46) W
11	2549.685 32(18)*	647.08	0.351E-23	P(56) W	46	2554.762 98(13)*	2.43	0.327E-22	P(3) A
12	2549.805 55(74)	821.33	0.476E-23	R(38) B	47	2555.176 09(13)*	1.22	0.219E-22	P(2) A
13	2549.895 61(64)	821.64	0.475E-23	R(38) C	48	2555.183 07(18)*	419.73	0.971E-23	P(45) W
14	2549.974 81(12)*	42.60	0.125E-21	P(14) A	49	2555.322 99(39)	940.66	0.709E-24	P(45) X
15	2550.031 03(41)	1168.28	0.234E-24	P(56) X	50	2555.585 50(13)*	0.41	0.110E-22	P(1) A
16	2550.072 10(86)	837.16	0.452E-23	R(39) B	51	2555.586 69(36)	357.27	0.548E-24	P(42) Q
17	2550.166 33(73)	837.49	0.451E-23	R(39) C	52	2555.671 62(18)*	401.49	0.105E-22	P(44) W
18	2550.194 48(18)*	624.39	0.390E-23	P(55) W	53	2556.057 43(35)	340.66	0.586E-24	P(41) Q
19	2550.428 57(12)*	36.92	0.120E-21	P(13) A	54	2556.158 29(18)*	383.65	0.113E-22	P(43) W
20	2550.433 58(83)	853.74	0.427E-23	R(40) C	55	2556.267 34(38)	904.54	0.838E-24	P(43) X
21	2550.518 82(41)	1145.56	0.262E-24	P(55) X	56	2556.393 23(13)*	0.00	0.110E-22	R(0) A
22	2550.697 34(96)	870.40	0.404E-23	R(41) C	57	2556.526 35(35)	324.44	0.625E-24	P(40) Q
23	2550.701 77(18)*	602.10	0.432E-23	P(54) W	58	2556.643 10(18)*	366.22	0.122E-22	P(42) W
24	2550.878 63(12)*	31.64	0.113E-21	P(12) A	59	2556.737 41(38)	887.08	0.907E-24	P(42) X
25	2551.005 29(41)	1123.25	0.293E-24	P(54) X	60	2556.791 54(13)*	0.41	0.220E-22	R(1) A
26	2551.325 01(12)*	26.78	0.106E-21	P(11) A	61	2556.993 44(35)	308.62	0.666E-24	P(39) Q
27	2551.490 43(41)	1101.34	0.326E-24	P(53) X	62	2557.126 02(18)*	349.19	0.130E-22	P(41) W
28	2551.710 73(18)*	558.74	0.526E-23	P(52) W	63	2557.186 15(13)*	1.22	0.329E-22	R(2) A
29	2551.767 68(12)*	22.31	0.989E-22	P(10) A	64	2557.206 05(38)	870.04	0.980E-24	P(41) X
30	2551.974 25(41)	1079.84	0.363E-24	P(52) X	65	2557.458 72(35)	293.19	0.707E-24	P(38) Q
31	2552.206 67(13)*	18.26	0.908E-22	P(9) A	66	2557.577 05(13)*	2.43	0.437E-22	R(3) A
32	2552.212 40(18)*	537.67	0.578E-23	P(51) W	67	2557.607 07(18)*	332.57	0.139E-22	P(40) W
33	2552.641 96(13)*	14.61	0.822E-22	P(8) A	68	2557.673 27(38)	853.39	0.105E-23	P(40) X
34	2552.712 20(18)*	517.00	0.634E-23	P(50) W	69	2557.922 18(35)	278.16	0.748E-24	P(37) Q
35	2552.937 85(40)	1038.05	0.445E-24	P(50) X	70	2557.964 24(13)*	4.06	0.542E-22	R(4) A

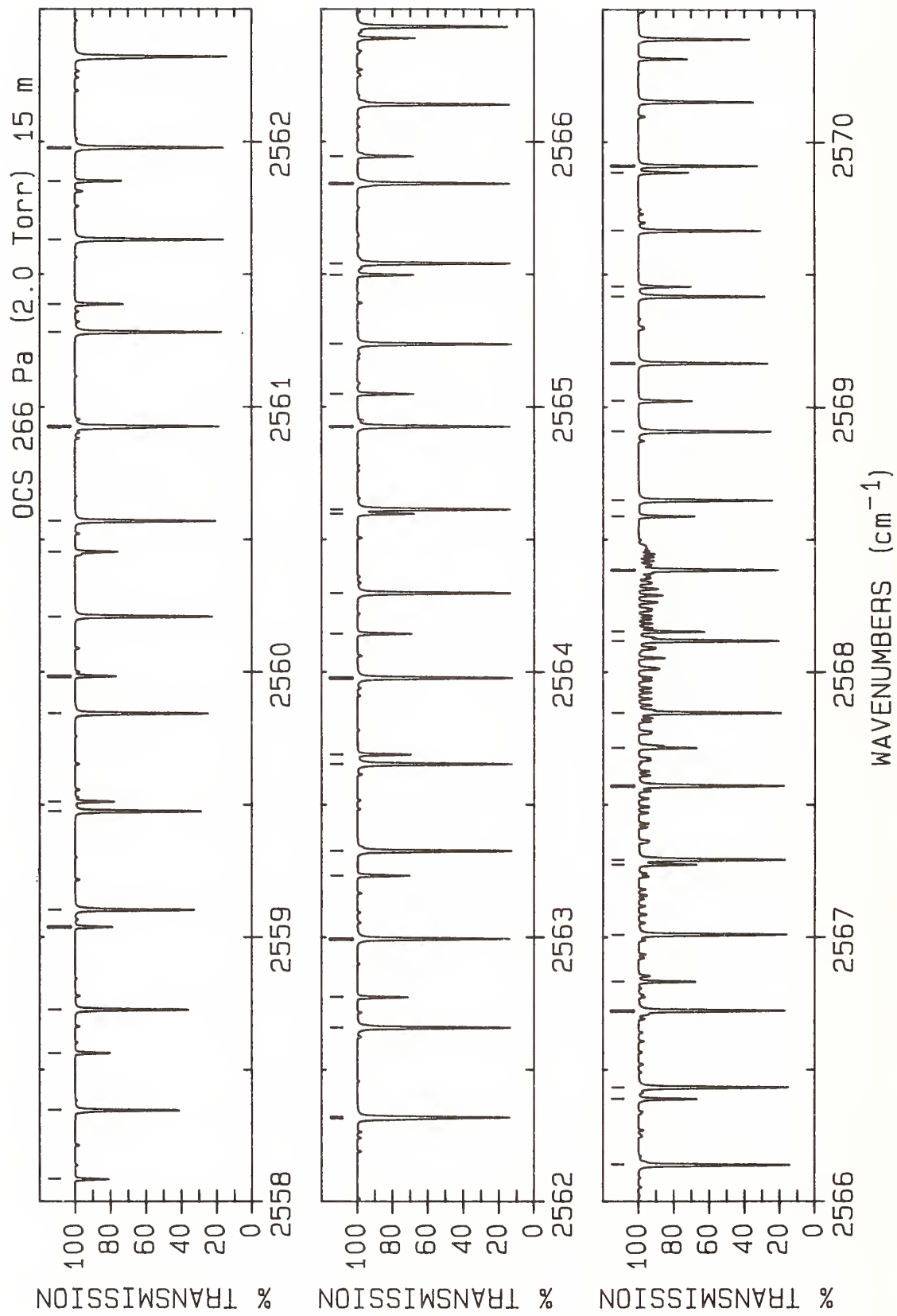

LINE #	WAVENUMBER(unc) (cm ⁻¹)	LOWER STATE (cm ⁻¹)	INTENSITY (cm/molecule)	ASSIGNMENT ROTATION BAND	LINE #	WAVENUMBER(unc) (cm ⁻¹)	LOWER STATE (cm ⁻¹)	INTENSITY (cm/molecule)	ASSIGNMENT ROTATION BAND
1	2558.086 25(18)*	316.35	0.149E-22	P(39)	36	2565.048 68(18)*	121.70	0.273E-22	P(24)
2	2558.347 73(13)*	6.09	0.644E-22	R(5)	37	2565.236 14(12)*	131.84	0.152E-21	R(25)
3	2558.563 55(18)*	300.54	0.158E-22	P(38)	38	2565.497 81(18)*	111.96	0.277E-22	P(23)
4	2558.727 51(13)*	8.52	0.742E-22	R(6)	39	2565.541 32(12)*	142.38	0.150E-21	R(26)
5	2559.038 97(18)*	285.13	0.168E-22	P(37)	40	2565.842 75(12)*	153.34	0.147E-21	R(27)
6	2559.103 58(13)*	11.36	0.837E-22	R(7)	41	2565.945 06(18)*	102.63	0.280E-22	P(22)
7	2559.475 94(12)*	14.61	0.927E-22	R(8)	42	2566.140 41(12)*	164.69	0.144E-21	R(28)
8	2559.512 52(18)*	270.13	0.177E-22	P(36)	43	2566.390 44(18)*	93.71	0.281E-22	P(21)
9	2559.844 58(12)*	18.26	0.101E-21	R(9)	44	2566.434 31(12)*	176.45	0.141E-21	R(29)
10	2559.984 19(18)*	255.53	0.187E-22	P(35)	45	2566.724 44(12)*	188.62	0.137E-21	R(30)
11	2560.209 51(12)*	22.31	0.109E-21	R(10)	46	2566.833 93(18)*	85.19	0.281E-22	P(20)
12	2560.453 99(18)*	241.34	0.197E-22	P(34)	47	2567.010 81(12)*	201.19	0.134E-21	R(31)
13	2560.570 72(12)*	26.78	0.117E-21	R(11)	48	2567.275 53(18)*	77.08	0.280E-22	P(19)
14	2560.921 91(18)*	227.55	0.206E-22	P(33)	49	2567.293 40(12)*	214.17	0.129E-21	R(32)
15	2560.928 21(12)*	31.64	0.123E-21	R(12)	50	2567.572 22(12)*	227.55	0.125E-21	R(33)
16	2561.281 98(12)*	36.92	0.129E-21	R(13)	51	2567.715 26(18)*	69.37	0.277E-22	P(18)
17	2561.387 95(18)*	214.17	0.216E-22	P(32)	52	2567.847 25(12)*	241.34	0.120E-21	R(34)
18	2561.632 03(12)*	42.60	0.135E-21	R(14)	53	2568.118 51(12)*	255.53	0.115E-21	R(35)
19	2561.852 12(18)*	201.19	0.225E-22	P(31)	54	2568.153 10(18)*	62.07	0.273E-22	P(17)
20	2561.978 35(12)*	48.68	0.140E-21	R(15)	55	2568.385 97(12)*	270.13	0.111E-21	R(36)
21	2562.314 40(18)*	188.62	0.233E-22	P(30)	56	2568.589 06(18)*	55.17	0.268E-22	P(16)
22	2562.320 95(12)*	55.17	0.144E-21	R(16)	57	2568.649 65(12)*	285.13	0.106E-21	R(37)
23	2562.659 81(12)*	62.07	0.147E-21	R(17)	58	2568.909 53(12)*	300.54	0.101E-21	R(38)
24	2562.774 81(18)*	176.45	0.242E-22	P(29)	59	2569.023 13(18)*	48.68	0.260E-22	P(15)
25	2562.994 94(12)*	69.37	0.150E-21	R(18)	60	2569.165 62(12)*	316.35	0.954E-22	R(39)
26	2563.233 34(18)*	164.69	0.249E-22	P(28)	61	2569.417 90(12)*	332.57	0.904E-22	R(40)
27	2563.326 34(12)*	77.08	0.152E-21	R(19)	62	2569.455 32(18)*	42.60	0.252E-22	P(14)
28	2563.654 00(12)*	85.19	0.154E-21	R(20)	63	2569.666 38(12)*	349.19	0.854E-22	R(41)
29	2563.690 00(18)*	153.34	0.257E-22	P(27)	64	2569.885 62(18)*	36.92	0.241E-22	P(13)
30	2563.977 92(12)*	93.71	0.155E-21	R(21)	65	2569.911 05(12)*	366.22	0.805E-22	R(42)
31	2564.144 77(18)*	142.38	0.263E-22	P(26)					
32	2564.298 09(12)*	102.63	0.155E-21	R(22)					
33	2564.597 66(18)*	131.84	0.269E-22	P(25)					
34	2564.614 53(12)*	111.96	0.154E-21	R(23)					
35	2564.927 21(12)*	121.70	0.153E-21	R(24)					

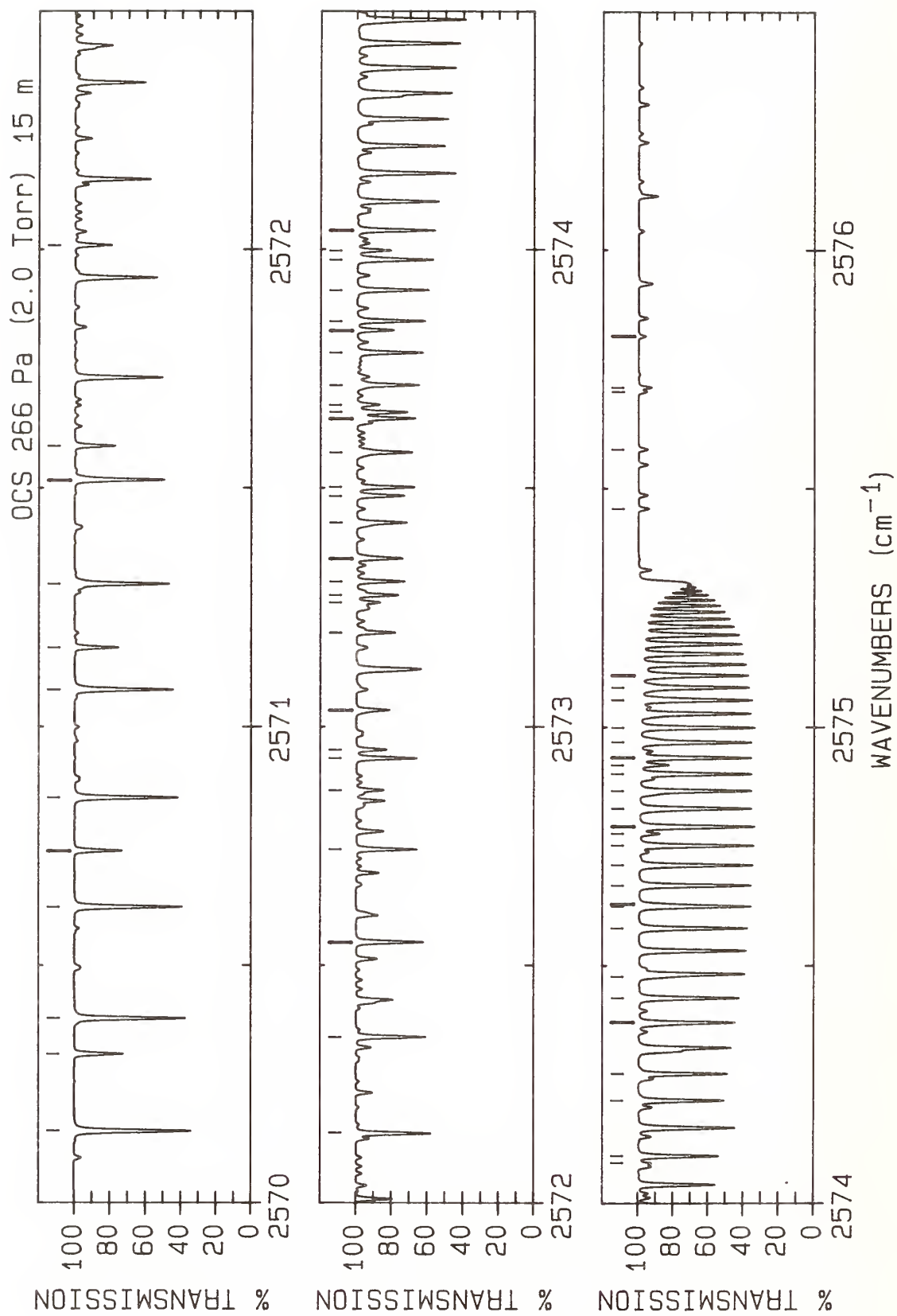

LINE #	WAVENUMBER(unc) (cm ⁻¹)	LOWER STATE (cm ⁻¹)	INTENSITY (cm/molecule)	ASSIGNMENT ROTATION BAND	LINE #	WAVENUMBER(unc) (cm ⁻¹)	LOWER STATE (cm ⁻¹)	INTENSITY (cm/molecule)	ASSIGNMENT ROTATION BAND
1	2570.151 90(12)*	383.65	0.757E-22	R(43) A	36	2573.849 63(18)*	401.49	0.345E-22	Q(44) W
2	2570.314 04(18)*	31.64	0.229E-22	P(12) W	37	2573.914 66(18)*	383.65	0.367E-22	Q(43) W
3	2570.388 94(12)*	401.49	0.710E-22	R(44) A	38	2573.978 19(18)*	366.22	0.391E-22	Q(42) W
4	2570.622 15(12)*	419.73	0.664E-22	R(45) A	39	2573.997 80(14)*	791.70	0.149E-22	R(62) A
5	2570.740 57(18)*	26.78	0.215E-22	P(11) W	40	2574.040 23(18)*	349.19	0.415E-22	Q(41) W
6	2570.851 54(12)*	438.37	0.620E-22	R(46) A	41	2574.084 76(18)*	2.43	0.524E-23	P(3) W
7	2571.077 10(13)*	457.42	0.577E-22	R(47) A	42	2574.100 77(18)*	332.57	0.439E-22	Q(40) W
8	2571.165 21(18)*	22.31	0.200E-22	P(10) W	43	2574.217 37(18)*	300.54	0.487E-22	Q(38) W
9	2571.298 83(13)*	476.88	0.536E-22	R(48) A	44	2574.273 43(18)*	285.13	0.511E-22	Q(37) W
10	2571.516 71(13)*	496.74	0.497E-22	R(49) A	45	2574.381 08(18)*	255.53	0.559E-22	Q(35) W
11	2571.587 96(18)*	18.26	0.183E-22	P(9) W	46	2574.432 67(18)*	241.34	0.582E-22	Q(34) W
12	2572.008 82(18)*	14.61	0.165E-22	P(8) W	47	2574.477 01(14)*	869.46	0.107E-22	R(65) A
13	2572.147 29(13)*	558.74	0.390E-22	R(52) A	48	2574.578 53(18)*	201.19	0.646E-22	Q(31) W
14	2572.349 78(13)*	580.22	0.358E-22	R(53) A	49	2574.624 18(18)*	188.62	0.665E-22	Q(30) W
15	2572.548 40(13)*	602.10	0.327E-22	R(54) A	50	2574.628 91(15)*	896.18	0.956E-23	R(66) A
16	2572.743 16(13)*	624.39	0.299E-22	R(55) A	51	2574.668 35(18)*	176.45	0.683E-22	Q(29) W
17	2572.867 31(18)*	670.17	0.121E-22	Q(57) W	52	2574.711 03(18)*	164.69	0.698E-22	Q(28) W
18	2572.934 04(13)*	647.08	0.273E-22	R(56) A	53	2574.752 24(18)*	153.34	0.712E-22	Q(27) W
19	2572.951 93(18)*	647.08	0.133E-22	Q(56) W	54	2574.776 89(15)*	923.31	0.851E-23	R(67) A
20	2573.035 04(18)*	624.39	0.146E-22	Q(55) W	55	2574.791 96(18)*	142.38	0.724E-22	Q(26) W
21	2573.196 72(18)*	580.22	0.174E-22	Q(53) W	56	2574.830 20(18)*	131.84	0.733E-22	Q(25) W
22	2573.260 06(18)*	6.09	0.101E-22	P(5) W	57	2574.866 97(18)*	121.70	0.740E-22	Q(24) W
23	2573.275 30(18)*	558.74	0.189E-22	Q(52) W	58	2574.902 26(18)*	111.96	0.744E-22	Q(23) W
24	2573.304 18(13)*	693.67	0.225E-22	R(58) A	59	2574.920 93(15)*	950.85	0.755E-23	R(68) A
25	2573.352 36(18)*	537.67	0.206E-22	Q(51) W	60	2574.936 07(18)*	102.63	0.745E-22	Q(22) W
26	2573.427 91(18)*	517.00	0.223E-22	Q(50) W	61	2574.968 41(18)*	93.71	0.744E-22	Q(21) W
27	2573.483 43(13)*	717.57	0.204E-22	R(59) A	62	2574.999 27(18)*	85.19	0.739E-22	Q(20) W
28	2573.501 96(18)*	496.74	0.241E-22	Q(49) W	63	2575.056 57(18)*	69.37	0.720E-22	Q(18) W
29	2573.574 50(18)*	476.88	0.260E-22	Q(48) W	64	2575.083 01(18)*	62.07	0.706E-22	Q(17) W
30	2573.645 53(18)*	457.42	0.280E-22	Q(47) W	65	2575.107 97(18)*	55.17	0.688E-22	Q(16) W
31	2573.658 78(14)*	741.87	0.184E-22	R(60) A	66	2575.457 68(20)*	1065.02	0.459E-23	R(72) A
32	2573.673 36(18)*	4.06	0.773E-23	P(4) W	67	2575.581 98(22)*	1094.57	0.403E-23	R(73) A
33	2573.715 07(18)*	438.37	0.301E-22	Q(46) W	68	2575.702 31(24)*	1124.52	0.353E-23	R(74) A
34	2573.783 10(18)*	419.73	0.323E-22	Q(45) W	69	2575.711 40(18)*	0.00	0.551E-23	R(0) W
35	2573.830 24(14)*	766.58	0.166E-22	R(61) A	70	2575.818 68(27)*	1154.87	0.309E-23	R(75) A

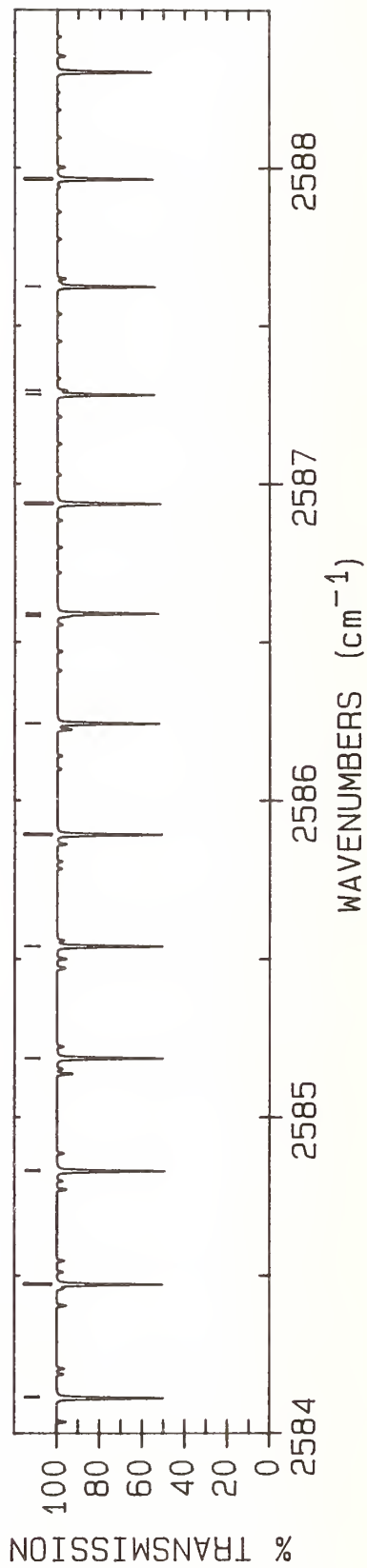
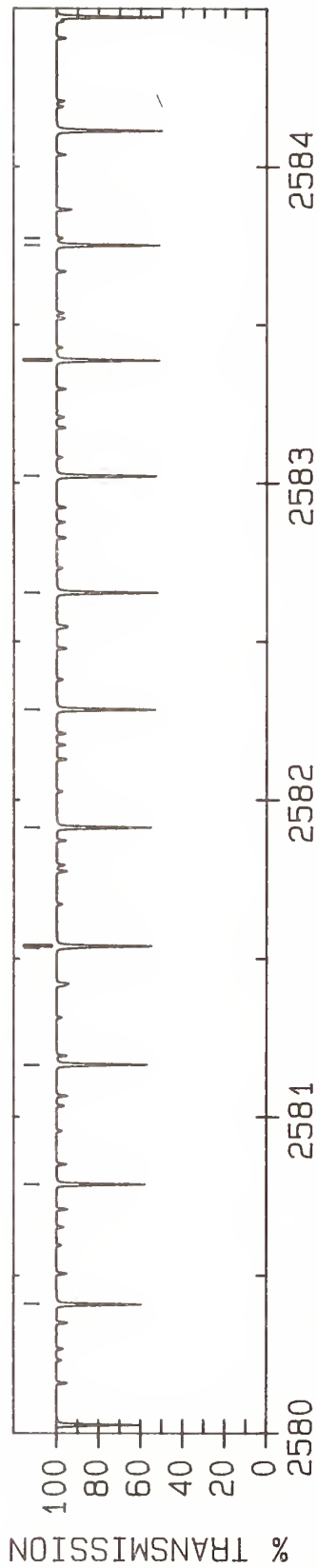
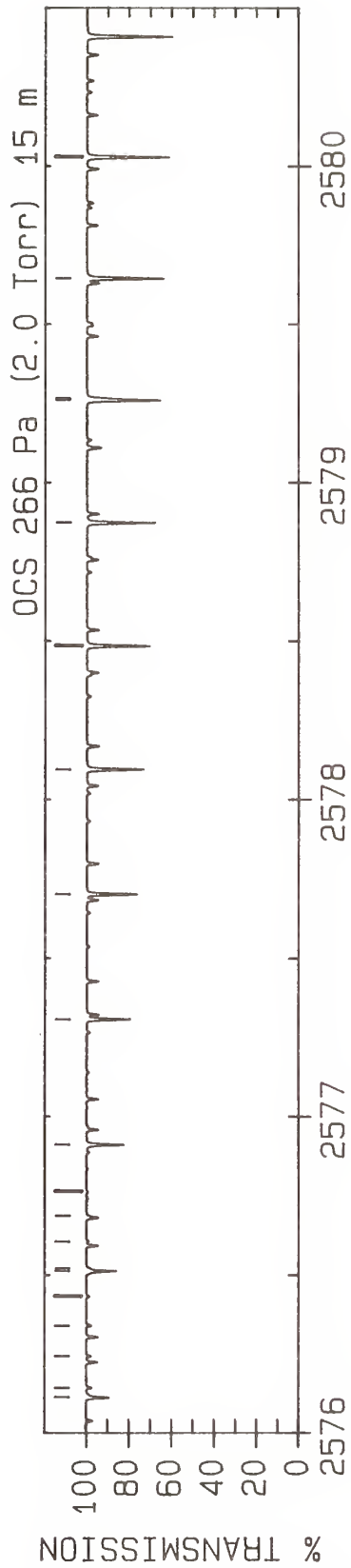

LINE #	WAVENUMBER(cm ⁻¹)	LOWER STATE (cm ⁻¹)	INTENSITY (cm/molecule)	ASSIGNMENT ROTATION BAND	LINE #	WAVENUMBER(unc) (cm ⁻¹)	LOWER STATE (cm ⁻¹)	INTENSITY (cm/molecule)	ASSIGNMENT ROTATION BAND
1	2576.113 32(18)*	0.41	0.832E-23	R(1) W	26	2581.913 36(18)*	55.17	0.438E-22	R(16) W
2	2576.143 90(37)	1248.35	0.204E-23	R(78) A	27	2582.284 73(18)*	62.07	0.451E-22	R(17) W
3	2576.244 33(42)	1280.32	0.177E-23	R(79) A	28	2582.654 17(18)*	69.37	0.462E-22	R(18) W
4	2576.340 76(47)	1312.69	0.153E-23	R(80) A	29	2583.021 69(18)*	77.08	0.472E-22	R(19) W
5	2576.433 18(53)	1345.46	0.132E-23	R(81) A	30	2583.387 29(18)*	85.19	0.479E-22	R(20) W
6	2576.513 33(18)*	1.22	0.112E-22	R(2) W	31	2583.750 96(18)*	93.71	0.485E-22	R(21) W
7	2576.521 60(59)	1378.63	0.114E-23	R(82) A	32	2583.773 20(35)	138.90	0.213E-23	R(26) Q
8	2576.606 00(66)	1412.21	0.977E-24	R(83) A	33	2584.112 70(18)*	102.63	0.489E-22	R(22) W
9	2576.686 37(74)	1446.18	0.838E-24	R(84) A	34	2584.116 96(35)	149.59	0.211E-23	R(27) Q
10	2576.762 72(83)	1480.56	0.717E-24	R(85) A	35	2584.472 51(18)*	111.96	0.490E-22	R(23) W
11	2576.911 45(18)*	2.43	0.140E-22	R(3) W	36	2584.830 39(18)*	121.70	0.491E-22	R(24) W
12	2577.307 66(18)*	4.06	0.168E-22	R(4) W	37	2584.833 0	922.82	0.217E-23	R(44) Z
13	2577.701 97(18)*	6.09	0.196E-22	R(5) W	38	2585.186 34(18)*	131.84	0.489E-22	R(25) W
14	2578.094 37(18)*	8.52	0.224E-22	R(6) W	39	2585.540 36(18)*	142.38	0.486E-22	R(26) W
15	2578.484 87(18)*	11.36	0.250E-22	R(7) W	40	2585.892 43(18)*	153.34	0.481E-22	R(27) W
16	2578.873 46(18)*	14.61	0.276E-22	R(8) W	41	2585.892 8	959.33	0.219E-23	R(46) Y
17	2579.260 14(18)*	18.26	0.301E-22	R(9) W	42	2586.242 58(18)*	164.69	0.475E-22	R(28) W
18	2579.266 0	673.94	0.430E-23	R(27) Y	43	2586.581 79(38)	697.09	0.326E-23	R(29) X
19	2579.644 92(18)*	22.31	0.325E-22	R(10) W	44	2586.590 78(18)*	176.45	0.467E-22	R(29) W
20	2580.027 78(18)*	26.78	0.348E-22	R(11) W	45	2586.937 04(18)*	188.62	0.458E-22	R(30) W
21	2580.408 73(18)*	31.64	0.369E-22	R(12) W	46	2586.939 07(38)	709.27	0.319E-23	R(30) X
22	2580.787 76(18)*	36.92	0.389E-22	R(13) W	47	2587.281 36(18)*	201.19	0.448E-22	R(31) W
23	2581.164 88(18)*	42.60	0.407E-22	R(14) W	48	2587.294 80(38)	721.86	0.312E-23	R(31) X
24	2581.533 8	762.31	0.346E-23	R(34) Z	49	2587.623 73(18)*	214.17	0.437E-22	R(32) W
25	2581.540 08(18)*	48.68	0.423E-22	R(15) W	50	2587.964 15(18)*	227.55	0.425E-22	R(33) W

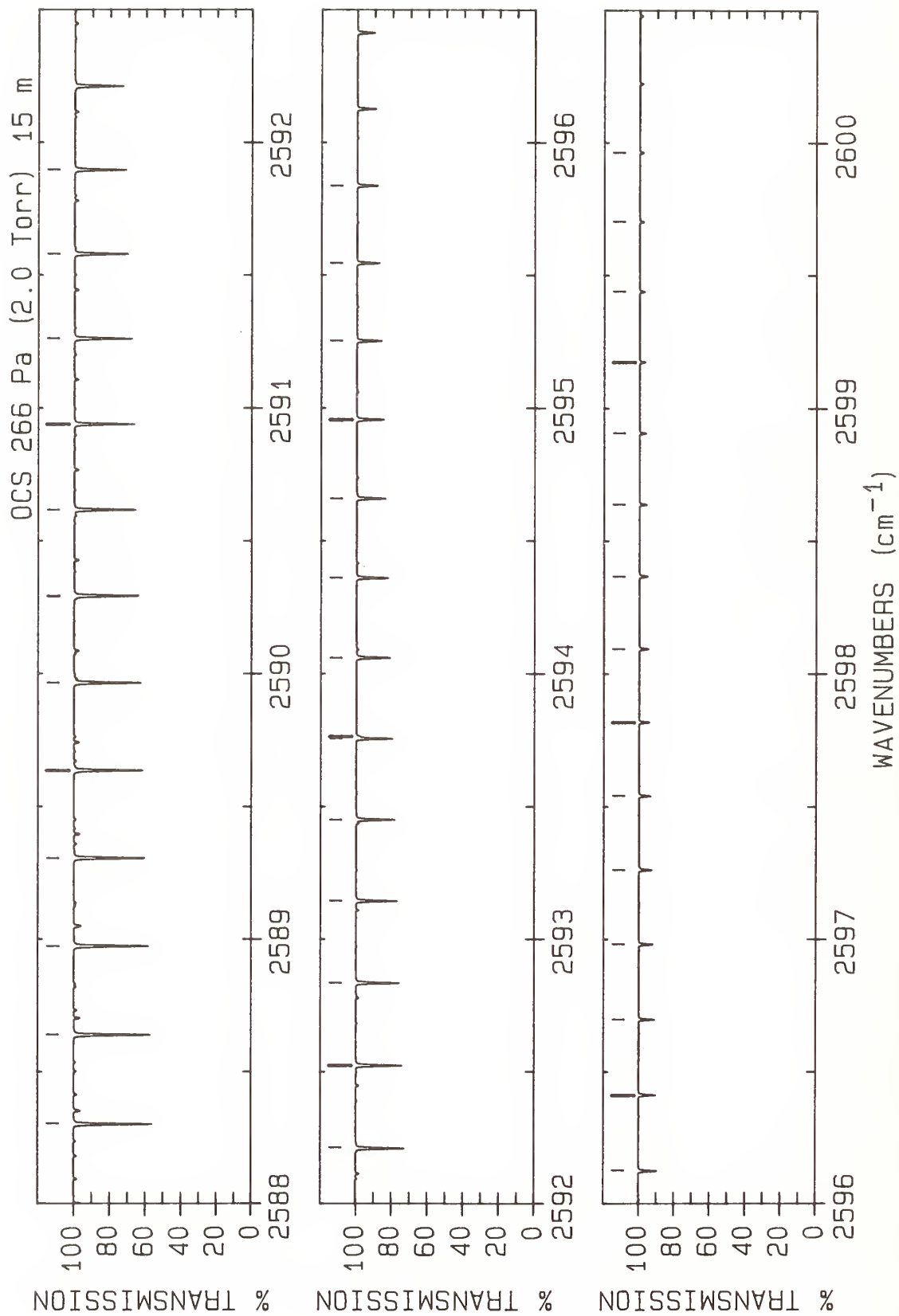

LINE #	WAVENUMBER(unc) (cm ⁻¹)	LOWER STATE (cm ⁻¹)	INTENSITY (cm/molecule)	ASSIGNMENT ROTATION BAND	LINE #	WAVENUMBER(unc) (cm ⁻¹)	LOWER STATE (cm ⁻¹)	INTENSITY (cm/molecule)	ASSIGNMENT ROTATION BAND
1	2588.302 63(18)*	241.34	0.413E-22	R(34) W	26	2595.252 37(18)*	647.08	0.110E-22	R(56) W
2	2588.639 16(18)*	255.53	0.399E-22	R(35) W	27	2595.545 51(18)*	670.17	0.100E-22	R(57) W
3	2588.973 74(18)*	270.13	0.385E-22	R(36) W	28	2595.836 66(18)*	693.67	0.918E-23	R(58) W
4	2589.306 36(18)*	285.13	0.370E-22	R(37) W	29	2596.125 81(18)*	717.57	0.837E-23	R(59) W
5	2589.637 02(18)*	300.54	0.355E-22	R(38) W	30	2596.412 96(18)*	741.87	0.762E-23	R(60) W
6	2589.965 73(18)*	316.35	0.340E-22	R(39) W	31	2596.698 11(18)*	766.58	0.692E-23	R(61) W
7	2590.289 15(37)	427.66	0.105E-23	R(46) Q	32	2596.981 26(18)*	791.70	0.626E-23	R(62) W
8	2590.292 48(18)*	332.57	0.324E-22	R(40) W	33	2597.262 41(18)*	817.21	0.566E-23	R(63) W
9	2590.617 27(18)*	349.19	0.308E-22	R(41) W	34	2597.541 55(18)*	843.13	0.510E-23	R(64) W
10	2590.940 09(18)*	366.22	0.293E-22	R(42) W	35	2597.818 69(18)*	869.46	0.459E-23	R(65) W
11	2591.260 95(18)*	383.65	0.277E-22	R(43) W	36	2598.093 81(18)*	896.18	0.412E-23	R(66) W
12	2591.579 84(18)*	401.49	0.262E-22	R(44) W	37	2598.366 93(18)*	923.31	0.369E-23	R(67) W
13	2591.896 76(18)*	419.73	0.247E-22	R(45) W	38	2598.638 03(18)*	950.85	0.330E-23	R(68) W
14	2592.211 71(18)*	438.37	0.232E-22	R(46) W	39	2598.907 12(19)*	978.78	0.294E-23	R(69) W
15	2592.524 69(18)*	457.42	0.218E-22	R(47) W	40	2599.174 19(19)*	1007.13	0.262E-23	R(70) W
16	2592.835 69(18)*	476.88	0.204E-22	R(48) W	41	2599.439 24(19)*	1035.87	0.232E-23	R(71) W
17	2593.144 72(18)*	496.74	0.190E-22	R(49) W	42	2599.702 28(19)*	1065.02	0.206E-23	R(72) W
18	2593.451 76(18)*	517.00	0.177E-22	R(50) W	43	2599.963 30(20)*	1094.57	0.182E-23	R(73) W
19	2593.756 83(18)*	537.67	0.164E-22	R(51) W					
20	2593.765 48(41)	1038.05	0.111E-23	R(50) X					
21	2594.059 91(18)*	558.74	0.152E-22	R(52) W					
22	2594.361 01(18)*	580.22	0.141E-22	R(53) W					
23	2594.660 12(18)*	602.10	0.130E-22	R(54) W					
24	2594.951 55(72)	772.36	0.297E-24	R(62) Q					
25	2594.957 24(18)*	624.39	0.119E-22	R(55) W					

ATLAS OF OCS ABSORPTION LINES FROM 2693 cm^{-1} to 2763 cm^{-1}

key:

Band	Isotopomer	Vibrational Transition
A	$^{16}\text{O}^{12}\text{C}^{32}\text{S}$	02 ⁰ 2-00 ⁰ 0
B		03 ¹ 2-01 ^{1e} 0
C		03 ¹ 2-01 ^{1f} 0
D		02 ⁰ 3-00 ⁰ 1
P	$^{16}\text{O}^{12}\text{C}^{34}\text{S}$	02 ⁰ 2-00 ⁰ 0

If the e or f designation is not specified (for $l \neq 0$), then the transition is to either level, depending on the selection rules and the change in the rotational quantum number, J . Spectra are given for a slitwidth of 0.003 cm^{-1} , a temperature of 296 K, and a transition moment of 0.004 debye for the A, D, and P bands and 0.0039 debye for the B and C bands. No Herman-Wallis constant was included in the intensity calculation.

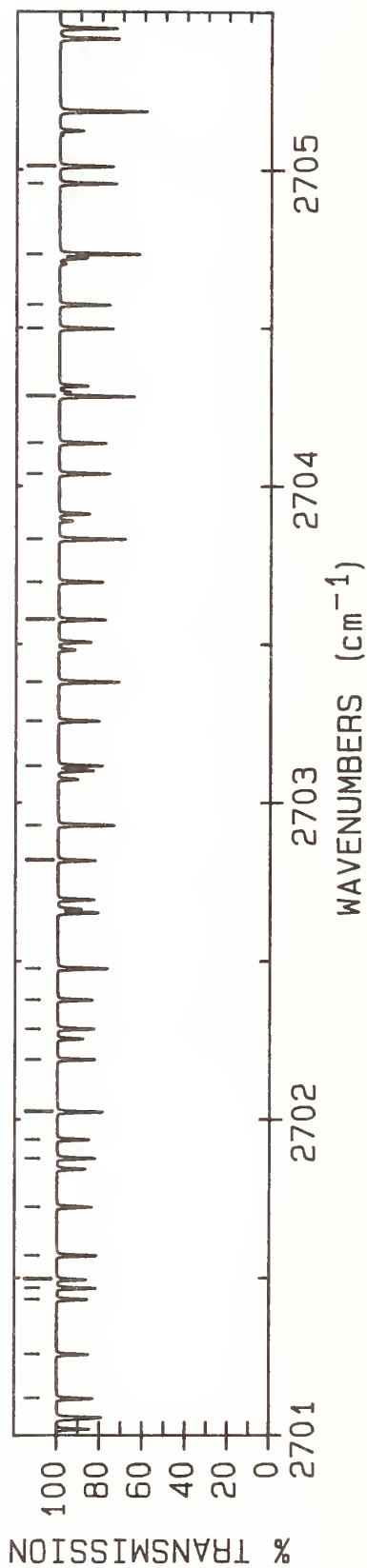
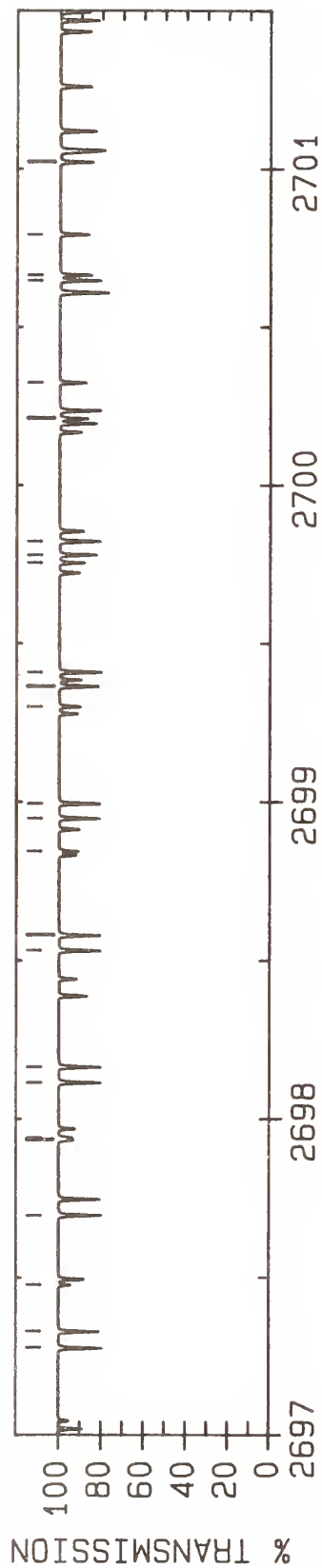
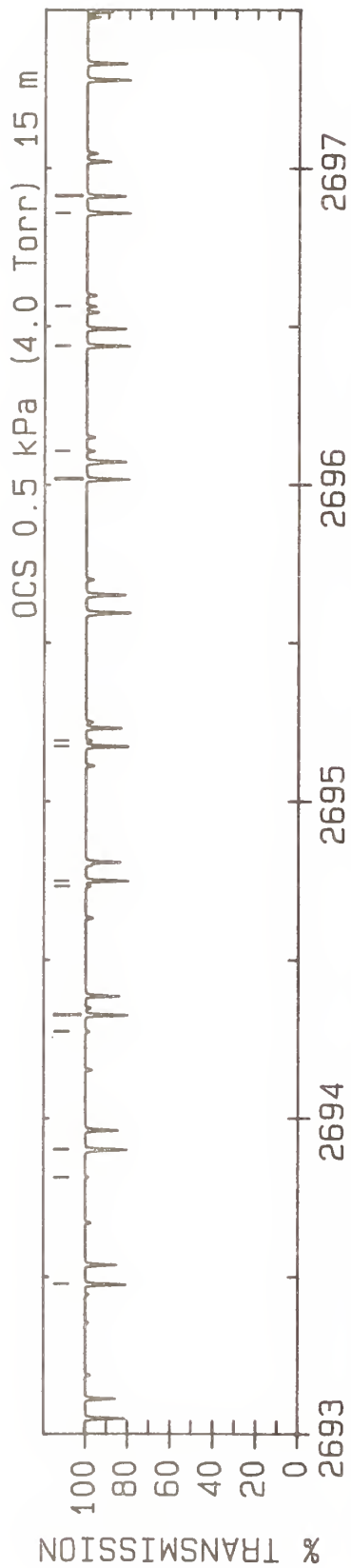

LINE #	WAVENUMBER(unc) (cm ⁻¹)	LOWER STATE (cm ⁻¹)	INTENSITY (cm/molecule)	ASSIGNMENT ROTATION BAND	LINE #	WAVENUMBER(unc) (cm ⁻¹)	LOWER STATE (cm ⁻¹)	INTENSITY (cm/molecule)	ASSIGNMENT ROTATION BAND
1	2693.476 77(65)	1034.89	0.782E-23	P(29)	36	2700.324 10(43)	1168.28	0.502E-23	B
2	2693.814 9	1515.34	0.664E-24	P(86)	37	2700.647 54(68)	75.19	0.789E-23	P
3	2693.901 86(64)	1023.17	0.800E-23	P(28)	38	2700.664 33(25)*	1035.87	0.602E-23	A
4	2694.273 92(88)*	1480.56	0.781E-24	P(85)	39	2700.792 05(39)	1145.56	0.551E-23	B
5	2694.326 27(62)	1011.84	0.815E-23	P(27)	40	2701.020 97(70)	885.66	0.616E-23	D
6	2694.732 57(77)*	1446.18	0.917E-24	P(84)	41	2701.118 15(25)*	1007.13	0.685E-23	A
7	2694.750 01(60)	1000.93	0.828E-23	P(26)	42	2701.258 98(35)	1123.25	0.603E-23	B
8	2695.173 06(57)	990.41	0.838E-23	P(25)	43	2701.433 15(74)	881.21	0.572E-23	D
9	2695.190 88(67)*	1412.21	0.107E-23	P(83)	44	2701.468 83(67)	60.55	0.758E-23	P
10	2696.017 10(52)	970.60	0.850E-23	P(23)	45	2701.495 64(34)	1146.22	0.550E-23	C
11	2696.106 52(52)*	1345.46	0.146E-23	P(81)	46	2701.571 57(25)*	978.78	0.777E-23	A
12	2696.438 07(50)	961.29	0.851E-23	P(22)	47	2701.724 89(32)	1101.34	0.659E-23	B
13	2696.563 85(45)*	1312.69	0.170E-23	P(80)	48	2701.878 24(70)	53.83	0.737E-23	P
14	2696.858 33(48)	952.40	0.848E-23	P(21)	49	2701.937 20(31)	1123.88	0.602E-23	C
15	2696.911 82(84)	160.67	0.766E-23	P(28)	50	2702.024 61(25)*	950.85	0.880E-23	A
16	2697.277 88(46)	943.90	0.842E-23	P(20)	51	2702.189 77(29)	1079.84	0.718E-23	B
17	2697.330 06(84)	149.59	0.780E-23	P(27)	52	2702.286 82(75)	47.49	0.713E-23	P
18	2697.477 49(36)*	1248.35	0.229E-23	P(78)	53	2702.378 14(29)	1101.95	0.658E-23	C
19	2697.696 71(46)	935.82	0.832E-23	P(19)	54	2702.477 26(25)*	923.31	0.994E-23	A
20	2697.933 80(33)*	1216.79	0.265E-23	P(77)	55	2702.818 47(28)	1080.42	0.717E-23	C
21	2697.941 33(77)	1339.47	0.245E-23	P(63)	56	2702.929 49(25)*	896.18	0.112E-22	A
22	2698.114 81(46)	928.13	0.819E-23	P(18)	57	2703.116 41(26)	1038.05	0.847E-23	B
23	2698.164 20(85)	128.62	0.800E-23	P(25)	58	2703.258 19(27)	1059.31	0.780E-23	C
24	2698.532 20(48)	920.85	0.801E-23	P(17)	59	2703.381 31(25)*	869.46	0.126E-22	A
25	2698.580 09(84)	118.72	0.806E-23	P(24)	60	2703.578 16(25)	1017.76	0.916E-23	B
26	2698.845 40(28)*	1154.87	0.351E-23	P(75)	61	2703.697 29(26)	1038.59	0.846E-23	C
27	2698.948 84(50)	913.98	0.780E-23	P(16)	62	2703.832 70(25)*	843.13	0.141E-22	A
28	2698.995 19(82)	109.23	0.809E-23	P(23)	63	2704.038 85(24)	997.88	0.989E-23	B
29	2699.300 67(27)*	1124.52	0.403E-23	P(74)	64	2704.135 78(26)	1018.28	0.915E-23	C
30	2699.364 76(53)	907.50	0.755E-23	P(15)	65	2704.283 67(25)*	817.21	0.158E-22	A
31	2699.409 48(79)	100.13	0.809E-23	P(22)	66	2704.498 48(24)	978.40	0.106E-22	B
32	2699.755 59(26)*	1094.57	0.462E-23	P(73)	67	2704.573 65(25)	998.38	0.988E-23	C
33	2699.779 93(57)	901.44	0.726E-23	P(14)	68	2704.734 18(25)*	791.70	0.177E-22	A
34	2699.822 98(75)	91.42	0.806E-23	P(21)	69	2704.957 04(24)	959.33	0.114E-22	B
35	2700.210 15(26)*	1065.02	0.528E-23	P(72)	70	2705.010 90(25)	978.88	0.106E-22	C

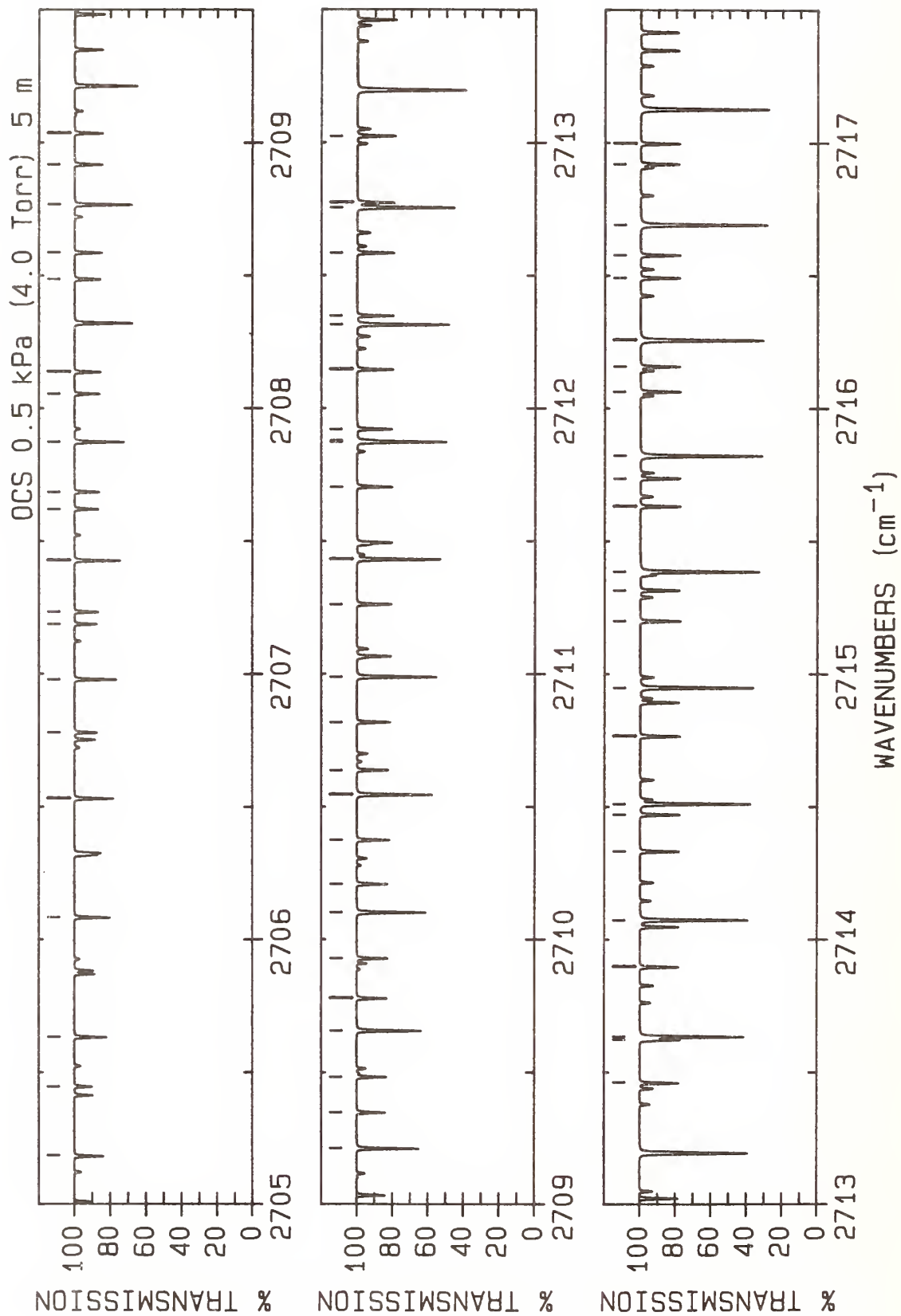

LINE #	WAVENUMBER(unc) (cm ⁻¹)	LOWER STATE (cm ⁻¹)	INTENSITY (cm/molecule)	ASSIGNMENT	ROTATION BAND	LINE #	WAVENUMBER(unc) (cm ⁻¹)	LOWER STATE (cm ⁻¹)	INTENSITY (cm/molecule)	ASSIGNMENT	ROTATION BAND
1	2705.184 25(25)*	766.58	0.197E-22	P(61)	A	36	2711.704 44(20)	721.86	0.246E-22	P(31)	B
2	2705.447 53(25)	959.78	0.114E-22	P(46)	C	37	2711.873 60(24)*	438.37	0.752E-22	P(46)	A
3	2705.633 85(25)*	741.87	0.219E-22	P(60)	A	38	2711.879 22(48)	907.50	0.809E-23	R(15)	D
4	2706.082 97(24)*	717.57	0.243E-22	P(59)	A	39	2711.921 69(19)	722.07	0.245E-22	P(31)	C
5	2706.531 62(24)*	693.67	0.269E-22	P(58)	A	40	2712.145 36(19)	709.27	0.253E-22	P(30)	B
6	2706.780 53(24)	887.08	0.149E-22	P(42)	B	41	2712.314 97(24)*	419.73	0.806E-22	P(45)	A
7	2706.979 76(24)*	670.17	0.297E-22	P(57)	A	42	2712.348 22(19)	709.47	0.252E-22	P(30)	C
8	2707.187 83(25)	887.47	0.148E-22	P(42)	C	43	2712.585 15(19)	697.09	0.259E-22	P(29)	B
9	2707.233 69(24)	870.04	0.158E-22	P(41)	B	44	2712.755 69(24)*	401.49	0.863E-22	P(44)	A
10	2707.427 40(24)*	647.08	0.327E-22	P(56)	A	45	2712.774 10(18)	697.27	0.259E-22	P(29)	C
11	2707.621 34(25)	870.40	0.158E-22	P(41)	C	46	2713.023 81(18)	685.31	0.265E-22	P(28)	B
12	2707.685 75(24)	853.39	0.167E-22	P(40)	B	47	2713.461 33(18)	673.94	0.270E-22	P(27)	B
13	2707.874 53(24)*	624.39	0.359E-22	P(55)	A	48	2713.623 93(17)	674.10	0.270E-22	P(27)	C
14	2708.054 23(25)	853.74	0.167E-22	P(40)	C	49	2713.635 21(24)*	366.22	0.979E-22	P(42)	A
15	2708.136 71(24)	837.16	0.176E-22	P(39)	B	50	2713.897 72(17)	662.98	0.274E-22	P(26)	B
16	2708.486 48(24)	837.49	0.176E-22	P(39)	C	51	2714.073 97(24)*	349.19	0.104E-21	P(41)	A
17	2708.586 57(23)	821.33	0.185E-22	P(38)	B	52	2714.332 96(17)	652.42	0.278E-22	P(25)	B
18	2708.767 18(24)*	580.22	0.431E-22	P(53)	A	53	2714.471 17(16)	652.56	0.278E-22	P(25)	C
19	2708.918 11(24)	821.64	0.185E-22	P(38)	C	54	2714.512 06(24)*	332.57	0.110E-21	P(40)	A
20	2709.035 33(23)	805.90	0.195E-22	P(37)	B	55	2714.767 07(17)	642.27	0.280E-22	P(24)	B
21	2709.212 69(24)*	558.74	0.470E-22	P(52)	A	56	2714.949 47(24)*	316.35	0.116E-21	P(39)	A
22	2709.349 10(23)	806.20	0.194E-22	P(37)	C	57	2715.200 03(16)	632.52	0.282E-22	P(23)	B
23	2709.482 97(23)	790.88	0.204E-22	P(36)	B	58	2715.315 80(16)	632.64	0.281E-22	P(23)	C
24	2709.657 64(24)*	537.67	0.511E-22	P(51)	A	59	2715.386 18(24)*	300.54	0.122E-21	P(38)	A
25	2709.779 46(23)	791.16	0.204E-22	P(36)	C	60	2715.631 84(16)	623.18	0.282E-22	P(22)	B
26	2709.929 50(22)	776.26	0.213E-22	P(35)	B	61	2715.737 13(16)	623.29	0.282E-22	P(22)	C
27	2710.102 02(24)*	517.00	0.555E-22	P(50)	A	62	2715.822 20(24)*	285.13	0.128E-21	P(37)	A
28	2710.209 18(22)	776.53	0.212E-22	P(35)	C	63	2716.062 51(16)	614.25	0.281E-22	P(21)	B
29	2710.374 92(22)	762.05	0.222E-22	P(34)	B	64	2716.157 82(16)	614.35	0.281E-22	P(21)	C
30	2710.545 81(24)*	496.74	0.601E-22	P(49)	A	65	2716.257 50(24)*	270.13	0.135E-21	P(36)	A
31	2710.638 27(21)	762.31	0.221E-22	P(34)	C	66	2716.492 02(17)	605.72	0.279E-22	P(20)	B
32	2710.819 21(21)	748.25	0.230E-22	P(33)	B	67	2716.577 84(17)	605.81	0.279E-22	P(20)	C
33	2710.989 02(24)*	476.88	0.649E-22	P(48)	A	68	2716.692 09(24)*	255.53	0.140E-21	P(35)	A
34	2711.262 39(21)	734.85	0.238E-22	P(32)	B	69	2716.920 39(17)	597.60	0.276E-22	P(19)	B
35	2711.431 62(24)*	457.42	0.700E-22	P(47)	A	70	2716.997 21(17)	597.68	0.275E-22	P(19)	C

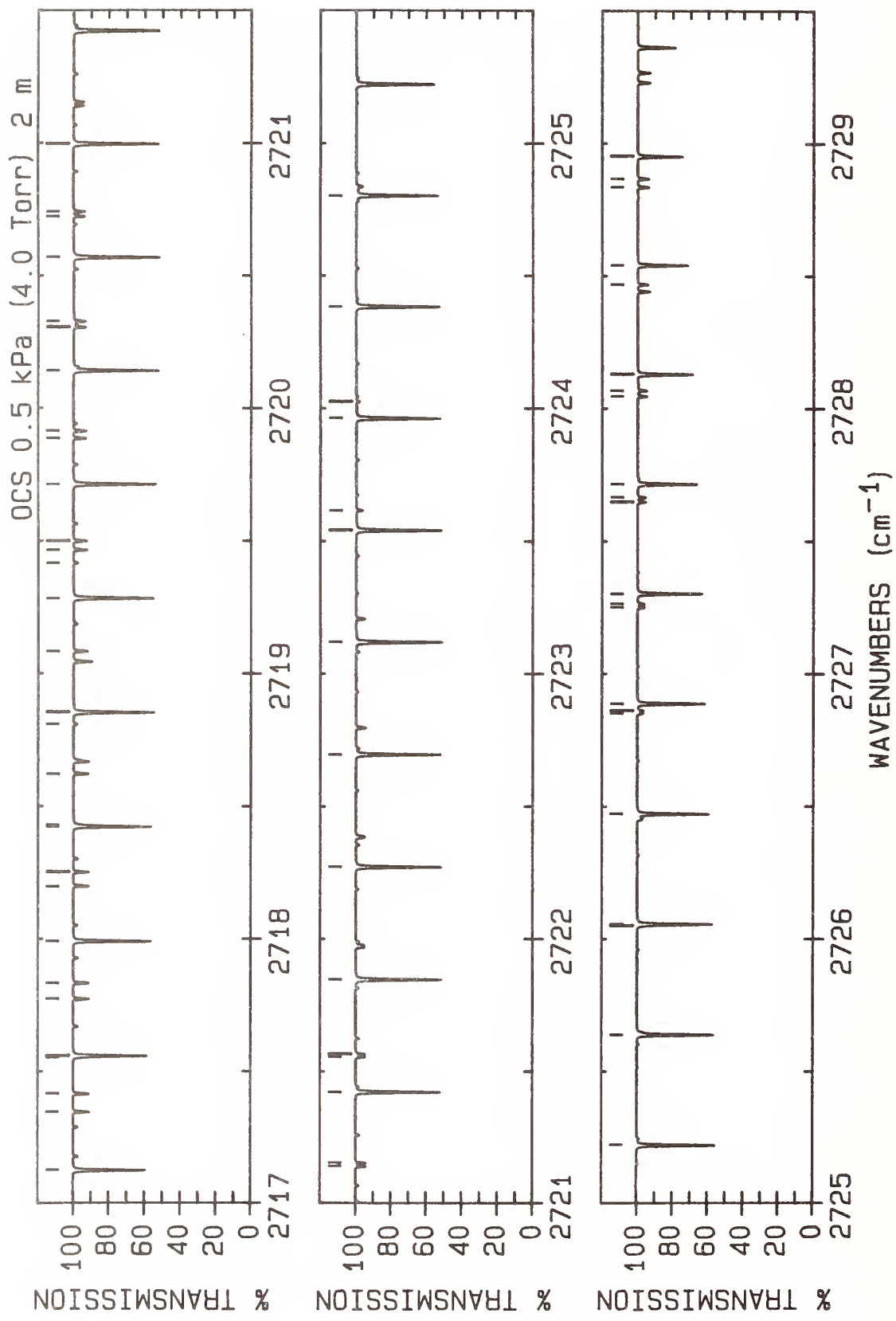

LINE #	WAVENUMBER(unc) (cm ⁻¹)	LOWER STATE (cm ⁻¹)	INTENSITY (cm/molecule)	ASSIGNMENT ROTATION BAND	LINE #	WAVENUMBER(unc) (cm ⁻¹)	LOWER STATE (cm ⁻¹)	INTENSITY (cm/molecule)	ASSIGNMENT ROTATION BAND	LINE #	WAVENUMBER(unc) (cm ⁻¹)	LOWER STATE (cm ⁻¹)	INTENSITY (cm/molecule)	ASSIGNMENT ROTATION BAND
1	2717.125 94(24)*	241.34	0.146E-21	P(34) A	36	2721.848 19(24)*	111.96	0.186E-21	P(23) A					
2	2717.347 60(17)	589.88	0.271E-22	P(18) B	37	2722.272 75(24)*	102.63	0.187E-21	P(22) A					
3	2717.415 92(17)	589.95	0.271E-22	P(18) C	38	2722.696 49(24)*	93.71	0.186E-21	P(21) A					
4	2717.553 33(85)	109.23	0.850E-23	R(23) P	39	2723.119 41(24)*	85.19	0.185E-21	P(20) A					
5	2717.559 06(24)*	227.55	0.152E-21	P(33) A	40	2723.541 51(24)*	77.08	0.183E-21	P(19) A					
6	2717.773 66(18)	582.57	0.265E-22	P(17) B	41	2723.616 37(24)	522.86	0.559E-23	P(3) B					
7	2717.833 96(18)	582.63	0.265E-22	P(17) C	42	2723.616 59(24)	522.86	0.559E-23	P(3) C					
8	2717.991 44(24)*	214.17	0.157E-21	P(32) A	43	2723.962 77(24)*	69.37	0.180E-21	P(18) A					
9	2718.198 56(18)	575.66	0.258E-22	P(16) B	44	2724.024 58(24)	521.64	0.316E-23	P(2) C					
10	2718.251 35(18)	575.72	0.258E-22	P(16) C	45	2724.024 93(24)	521.64	0.316E-23	P(2) B					
11	2718.423 07(24)*	201.19	0.162E-21	P(31) A	46	2724.383 19(24)*	62.07	0.176E-21	P(17) A					
12	2718.429 96(74)	1072.49	0.747E-23	R(32) D	47	2724.802 78(24)*	55.17	0.171E-21	P(16) A					
13	2718.622 30(19)	569.16	0.250E-22	P(15) B	48	2725.221 52(24)*	48.68	0.166E-21	P(15) A					
14	2718.808 80(79)	1085.84	0.721E-23	R(33) D	49	2725.639 42(24)*	42.60	0.159E-21	P(14) A					
15	2718.853 94(24)*	188.62	0.167E-21	P(30) A	50	2726.050 07(24)	521.64	0.563E-23	R(2) B					
16	2719.084 13(20)	563.12	0.240E-22	P(14) C	51	2726.054 32(24)	521.64	0.563E-23	R(2) C					
17	2719.284 04(24)*	176.45	0.171E-21	P(29) A	52	2726.056 46(24)*	36.92	0.152E-21	P(13) A					
18	2719.416 50(95)	160.67	0.800E-23	R(28) P	53	2726.472 65(24)*	31.64	0.144E-21	P(12) A					
19	2719.466 31(20)	557.38	0.229E-22	P(13) B	54	2726.851 86(24)	524.48	0.100E-22	R(4) B					
20	2719.499 53(20)	557.42	0.229E-22	P(13) C	55	2726.861 44(24)	524.49	0.100E-22	R(4) C					
21	2719.713 37(24)*	164.69	0.175E-21	P(28) A	56	2726.887 97(25)*	26.78	0.135E-21	P(11) A					
22	2719.886 57(21)	552.11	0.217E-22	P(12) B	57	2727.250 98(23)	526.51	0.120E-22	R(5) B					
23	2719.914 25(21)	552.14	0.216E-22	P(12) C	58	2727.263 96(23)	526.52	0.120E-22	R(5) C					
24	2720.141 92(23)*	153.34	0.179E-21	P(27) A	59	2727.302 44(25)*	22.31	0.126E-21	P(10) A					
25	2720.305 67(21)	547.23	0.203E-22	P(11) B	60	2727.648 92(23)	528.95	0.140E-22	R(6) B					
26	2720.328 31(21)	547.26	0.203E-22	P(11) C	61	2727.665 80(23)	528.96	0.140E-22	R(6) C					
27	2720.569 68(23)*	142.38	0.181E-21	P(26) A	62	2727.716 04(25)*	18.26	0.115E-21	P(9) A					
28	2720.723 60(22)	542.76	0.188E-22	P(10) B	63	2728.045 67(22)	531.80	0.158E-22	R(7) B					
29	2720.741 70(22)	542.79	0.188E-22	P(10) C	64	2728.066 95(22)	531.81	0.158E-22	R(7) C					
30	2720.996 66(23)*	131.84	0.184E-21	P(25) A	65	2728.128 77(25)*	14.61	0.104E-21	P(8) A					
31	2721.140 36(22)	538.70	0.172E-22	P(9) B	66	2728.467 41(22)	535.06	0.176E-22	R(8) C					
32	2721.154 42(22)	538.72	0.172E-22	P(9) C	67	2728.540 63(25)*	11.36	0.928E-22	P(7) A					
33	2721.422 83(23)*	121.70	0.185E-21	P(24) A	68	2728.835 62(21)	538.70	0.193E-22	R(9) B					
34	2721.555 96(23)	535.04	0.155E-22	P(8) B	69	2728.867 17(21)	538.72	0.192E-22	R(9) C					
35	2721.566 47(23)	535.06	0.155E-22	P(8) C	70	2728.951 62(25)*	8.52	0.806E-22	P(6) A					

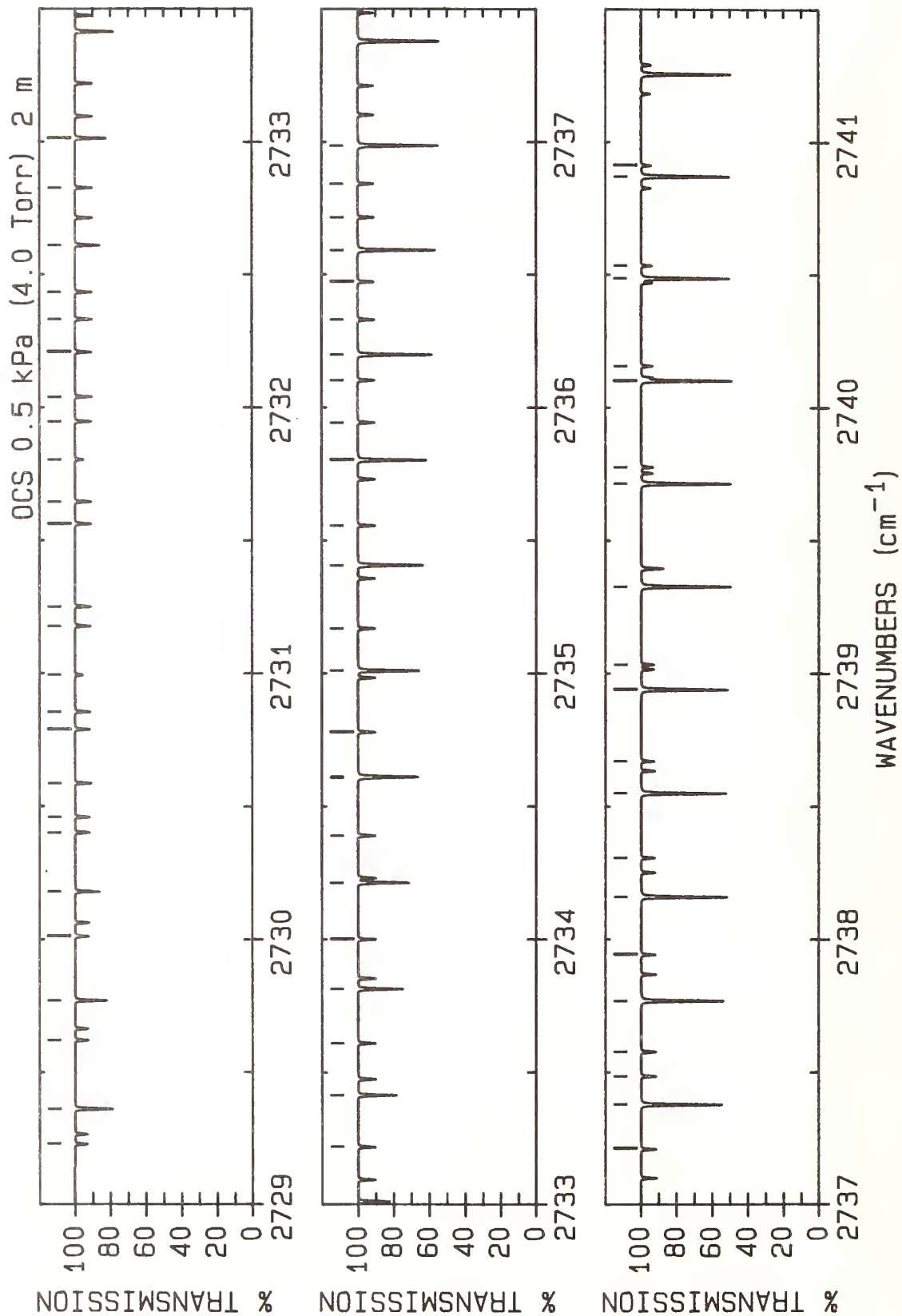

LINE #	WAVENUMBER(unc) (cm ⁻¹)	LOWER STATE (cm ⁻¹)	INTENSITY (cm/molecule)	ASSIGNMENT ROTATION BAND	LINE #	WAVENUMBER(unc) (cm ⁻¹)	LOWER STATE (cm ⁻¹)	INTENSITY (cm/molecule)	ASSIGNMENT ROTATION BAND
1	2729.228 81(21)	542.76	0.208E-22	R(10) B	36	2735.010 69(25)*	14.61	0.118E-21	R(8) A
2	2729.361 74(25)*	6.09	0.680E-22	P(5) A	37	2735.168 84(17)	652.56	0.291E-22	R(25) C
3	2729.620 81(20)	547.23	0.222E-22	R(11) B	38	2735.407 55(25)*	18.26	0.128E-21	R(9) A
4	2729.770 97(25)*	4.06	0.549E-22	P(4) A	39	2735.556 74(18)	663.13	0.287E-22	R(26) C
5	2730.011 62(19)	552.11	0.236E-22	R(12) B	40	2735.803 52(24)*	22.31	0.139E-21	R(10) A
6	2730.179 33(25)*	2.43	0.416E-22	P(3) A	41	2735.943 94(18)	674.10	0.282E-22	R(27) C
7	2730.401 25(19)	557.38	0.248E-22	R(13) B	42	2736.102 55(19)	685.31	0.277E-22	R(28) B
8	2730.459 32(19)	557.42	0.248E-22	R(13) C	43	2736.198 61(24)*	26.78	0.148E-21	R(11) A
9	2730.586 81(25)*	1.22	0.279E-22	P(2) A	44	2736.330 43(19)	685.49	0.277E-22	R(28) C
10	2730.789 68(18)	563.07	0.258E-22	R(14) B	45	2736.473 10(20)	697.09	0.271E-22	R(29) B
11	2730.855 62(18)	563.12	0.258E-22	R(14) C	46	2736.592 82(24)*	31.64	0.157E-21	R(12) A
12	2730.993 41(25)*	0.41	0.140E-22	P(1) A	47	2736.716 21(19)	697.27	0.270E-22	R(29) C
13	2731.176 93(18)	569.16	0.268E-22	R(15) B	48	2736.842 45(21)	709.27	0.264E-22	R(30) B
14	2731.251 23(18)	569.22	0.268E-22	R(15) C	49	2736.986 15(24)*	36.92	0.164E-21	R(13) A
15	2731.562 98(17)	575.66	0.276E-22	R(16) B	50	2737.210 61(21)	721.86	0.256E-22	R(31) B
16	2731.646 14(17)	575.72	0.275E-22	R(16) C	51	2737.378 60(24)*	42.60	0.171E-21	R(14) A
17	2731.803 95(25)*	0.00	0.140E-22	R(0) A	52	2737.485 65(21)	722.07	0.256E-22	R(31) C
18	2731.947 84(17)	582.57	0.282E-22	R(17) B	53	2737.577 57(22)	734.85	0.248E-22	R(32) B
19	2732.040 35(17)	582.63	0.282E-22	R(17) C	54	2737.770 17(24)*	48.68	0.177E-21	R(15) A
20	2732.207 89(25)*	0.41	0.280E-22	R(1) A	55	2737.943 35(22)	748.25	0.239E-22	R(33) B
21	2732.331 50(17)	589.88	0.288E-22	R(18) B	56	2738.160 87(24)*	55.17	0.183E-21	R(16) A
22	2732.433 86(17)	589.95	0.288E-22	R(18) C	57	2738.307 94(23)	762.05	0.230E-22	R(34) B
23	2732.610 95(25)*	1.22	0.418E-22	R(2) A	58	2738.550 70(24)*	62.07	0.187E-21	R(17) A
24	2732.826 68(16)	597.68	0.292E-22	R(19) C	59	2738.671 34(23)	776.26	0.221E-22	R(35) B
25	2733.013 13(25)*	2.43	0.554E-22	R(3) A	60	2738.939 66(24)*	69.37	0.191E-21	R(18) A
26	2733.218 79(16)	605.81	0.295E-22	R(20) C	61	2739.033 55(23)	790.88	0.212E-22	R(36) B
27	2733.414 41(25)*	4.06	0.688E-22	R(4) A	62	2739.327 75(24)*	77.08	0.193E-21	R(19) A
28	2733.610 21(16)	614.35	0.296E-22	R(21) C	63	2739.714 97(24)*	85.19	0.195E-21	R(20) A
29	2733.814 81(25)*	6.09	0.817E-22	R(5) A	64	2739.776 97(24)	806.20	0.202E-22	R(37) C
30	2734.000 92(16)	623.29	0.297E-22	R(22) C	65	2740.101 34(24)*	93.71	0.196E-21	R(21) A
31	2734.214 33(25)*	8.52	0.943E-22	R(6) A	66	2740.156 36(25)	821.64	0.192E-22	R(38) C
32	2734.390 93(16)	632.64	0.296E-22	R(23) C	67	2740.486 85(23)*	102.63	0.196E-21	R(22) A
33	2734.608 46(17)	642.27	0.294E-22	R(24) B	68	2740.535 04(25)	837.49	0.183E-22	R(39) C
34	2734.612 95(25)*	11.36	0.106E-21	R(7) A	69	2740.871 50(23)*	111.96	0.196E-21	R(23) A
35	2734.780 24(17)	642.40	0.294E-22	R(24) C	70	2740.913 01(25)	853.74	0.173E-22	R(40) C

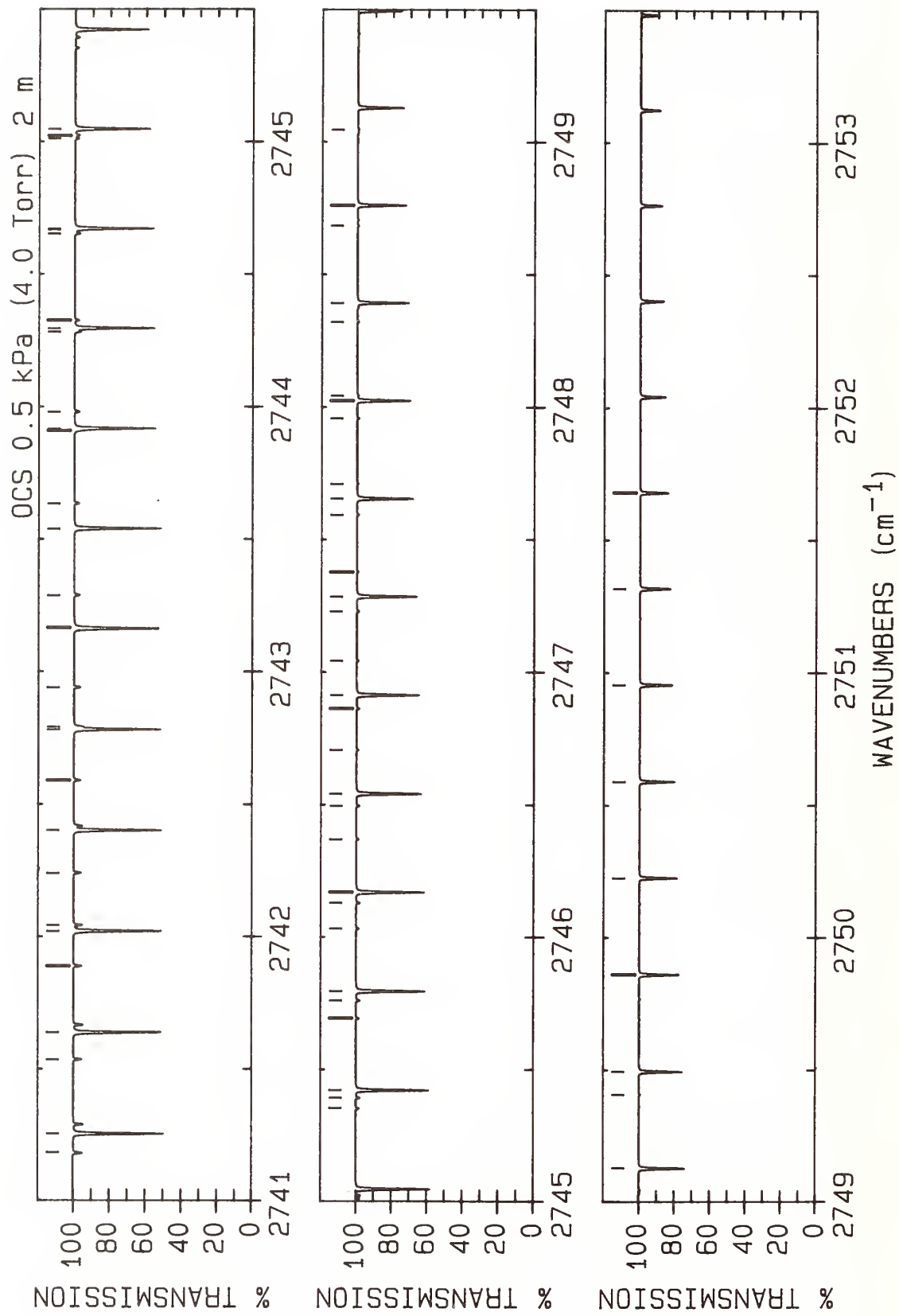

LINE #	WAVENUMBER(unc) (cm ⁻¹)	LOWER STATE (cm ⁻¹)	INTENSITY (cm/molecule)	ASSIGNMENT ROTATION BAND	LINE #	WAVENUMBER(unc) (cm ⁻¹)	LOWER STATE (cm ⁻¹)	INTENSITY (cm/molecule)	ASSIGNMENT ROTATION BAND	LINE #	WAVENUMBER(unc) (cm ⁻¹)	LOWER STATE (cm ⁻¹)	INTENSITY (cm/molecule)	ASSIGNMENT ROTATION BAND
1	2741.182 00(24)	887.08	0.154E-22	R(42) B	36	2745.761 29(34)	1101.95	0.681E-23	R(53) C					
2	2741.255 31(23)*	121.70	0.194E-21	R(24) A	37	2745.796 37(24)*	270.13	0.140E-21	R(36) A					
3	2741.535 95(24)	904.54	0.145E-22	R(43) B	38	2746.032 06(53)	1168.28	0.519E-23	R(56) B					
4	2741.638 27(23)*	131.84	0.193E-21	R(25) A	39	2746.129 18(37)	1123.88	0.623E-23	R(54) C					
5	2741.888 73(24)	922.39	0.136E-22	R(44) B	40	2746.169 58(24)*	285.13	0.133E-21	R(37) A					
6	2742.020 38(24)*	142.38	0.190E-21	R(26) A	41	2746.369 97(60)	1191.40	0.472E-23	R(57) B					
7	2742.042 63(25)	904.94	0.145E-22	R(43) C	42	2746.496 34(41)	1146.22	0.569E-23	R(55) C					
8	2742.240 35(24)	940.66	0.127E-22	R(45) B	43	2746.542 01(24)*	300.54	0.127E-21	R(38) A					
9	2742.401 66(24)*	153.34	0.187E-21	R(27) A	44	2746.706 78(66)	1214.93	0.428E-23	R(58) B					
10	2742.590 79(24)	959.33	0.119E-22	R(46) B	45	2746.862 77(45)	1168.96	0.519E-23	R(56) C					
11	2742.782 11(24)*	164.69	0.183E-21	R(28) A	46	2746.913 68(24)*	316.35	0.120E-21	R(39) A					
12	2742.792 12(25)	941.10	0.127E-22	R(45) C	47	2747.042 49(74)	1238.86	0.387E-23	R(59) B					
13	2742.940 08(25)	978.40	0.110E-22	R(47) B	48	2747.228 48(50)	1192.10	0.471E-23	R(57) C					
14	2743.161 73(24)*	176.45	0.179E-21	R(29) A	49	2747.284 59(24)*	332.57	0.114E-21	R(40) A					
15	2743.165 79(25)	959.78	0.118E-22	R(46) C	50	2747.377 11(82)	1263.19	0.349E-23	R(60) B					
16	2743.288 21(26)	997.88	0.102E-22	R(48) B	51	2747.593 46(56)	1215.65	0.428E-23	R(58) C					
17	2743.538 74(26)	978.88	0.110E-22	R(47) C	52	2747.654 75(24)*	349.19	0.108E-21	R(41) A					
18	2743.540 53(24)*	188.62	0.174E-21	R(30) A	53	2747.710 65(90)	1287.93	0.315E-23	R(61) B					
19	2743.635 18(27)	1017.76	0.948E-23	R(49) B	54	2747.957 70(63)	1239.61	0.387E-23	R(59) C					
20	2743.910 97(26)	998.38	0.102E-22	R(48) C	55	2748.024 17(24)*	366.22	0.101E-21	R(42) A					
21	2743.918 51(24)*	201.19	0.169E-21	R(31) A	56	2748.043 1	1313.07	0.283E-23	R(62) B					
22	2743.981 00(29)	1038.05	0.876E-23	R(50) B	57	2748.321 21(70)	1263.97	0.349E-23	R(60) C					
23	2744.282 48(27)	1018.28	0.947E-23	R(49) C	58	2748.392 85(24)*	383.65	0.952E-22	R(43) A					
24	2744.295 68(24)*	214.17	0.164E-21	R(32) A	59	2748.683 99(77)	1288.73	0.315E-23	R(61) C					
25	2744.325 68(32)	1058.74	0.808E-23	R(51) B	60	2748.760 80(24)*	401.49	0.892E-22	R(44) A					
26	2744.653 27(28)	1038.59	0.875E-23	R(50) C	61	2749.046 03(86)	1313.90	0.283E-23	R(62) C					
27	2744.669 22(35)	1079.84	0.743E-23	R(52) B	62	2749.128 04(24)*	419.73	0.834E-22	R(45) A					
28	2744.672 05(24)*	227.55	0.158E-21	R(33) A	63	2749.407 33(95)	1339.47	0.254E-23	R(63) C					
29	2745.011 62(39)	1101.34	0.681E-23	R(53) B	64	2749.494 56(24)*	438.37	0.777E-22	R(46) A					
30	2745.023 33(29)	1059.31	0.807E-23	R(51) C	65	2749.860 38(24)*	457.42	0.723E-22	R(47) A					
31	2745.047 61(24)*	241.34	0.152E-21	R(34) A	66	2750.225 51(24)*	476.88	0.671E-22	R(48) A					
32	2745.352 89(43)	1123.25	0.624E-23	R(54) B	67	2750.589 95(24)*	496.74	0.621E-22	R(49) A					
33	2745.392 67(31)	1080.42	0.742E-23	R(52) C	68	2750.953 72(24)*	517.00	0.573E-22	R(50) A					
34	2745.422 38(24)*	255.53	0.146E-21	R(35) A	69	2751.316 82(24)*	537.67	0.528E-22	R(51) A					
35	2745.693 03(48)	1145.56	0.570E-23	R(55) B	70	2751.679 26(24)*	558.74	0.485E-22	R(52) A					

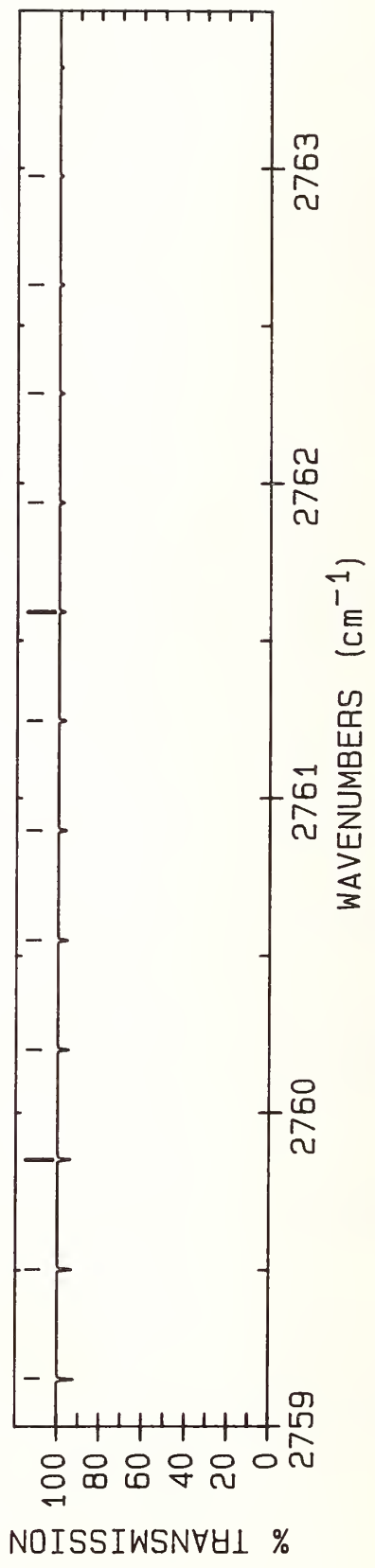
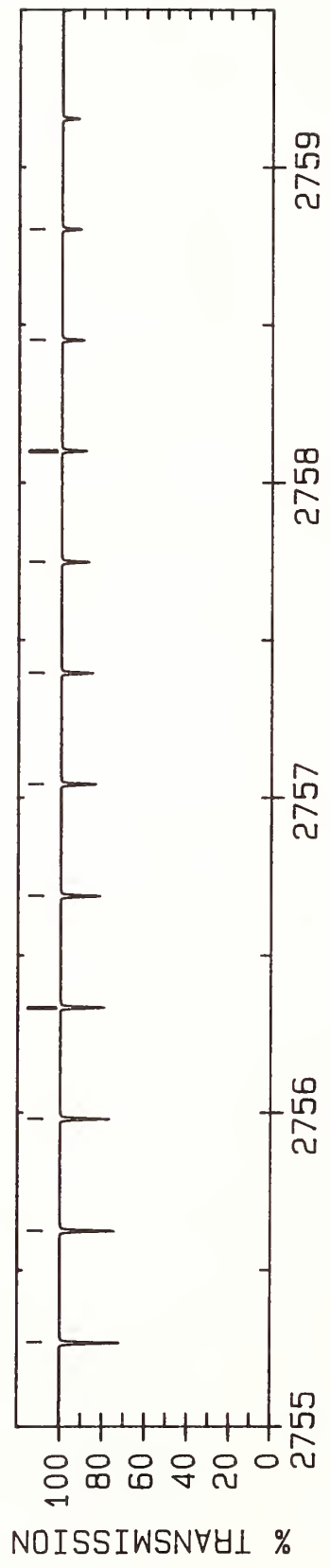
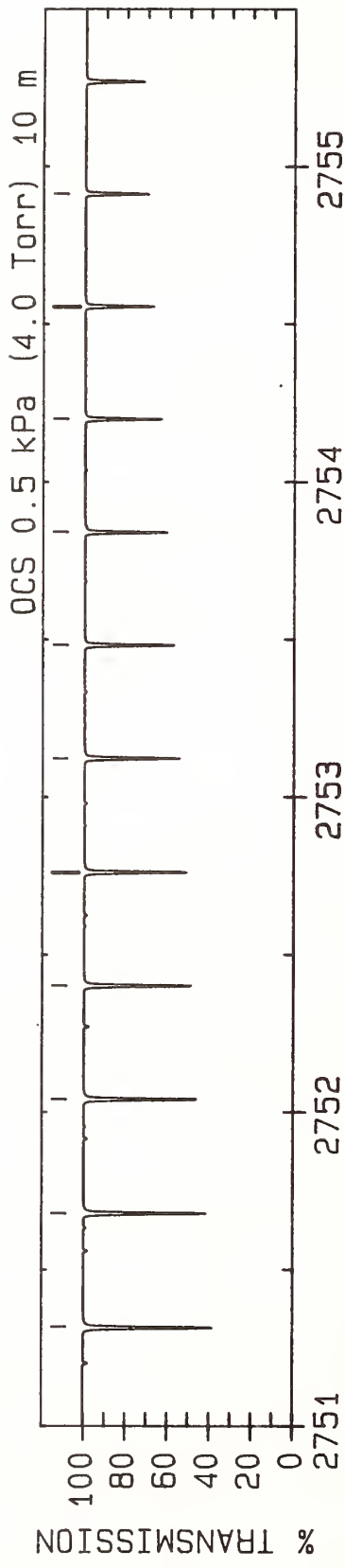

LINE #	WAVENUMBER(unc) (cm ⁻¹)	LOWER STATE (cm ⁻¹)	INTENSITY (cm/molecule)	ASSIGNMENT ROTATION BAND	LINE #	WAVENUMBER(unc) (cm ⁻¹)	LOWER STATE (cm ⁻¹)	INTENSITY (cm/molecule)	ASSIGNMENT ROTATION BAND
1	2751.316 82(24)*	537.67	0.528E-22	R(51) A	21	2758.451 62(26)*	1035.87	0.619E-23	R(71) A
2	2751.679 26(24)*	558.74	0.485E-22	R(52) A	22	2758.802 57(27)*	1065.02	0.543E-23	R(72) A
3	2752.041 05(24)*	580.22	0.444E-22	R(53) A	23	2759.153 01(28)*	1094.57	0.475E-23	R(73) A
4	2752.402 20(24)*	602.10	0.406E-22	R(54) A	24	2759.502 95(30)*	1124.52	0.415E-23	R(74) A
5	2752.762 72(24)*	624.39	0.371E-22	R(55) A	25	2759.852 38(33)*	1154.87	0.361E-23	R(75) A
6	2753.122 61(24)*	647.08	0.337E-22	R(56) A	26	2760.201 31(36)*	1185.63	0.314E-23	R(76) A
7	2753.481 89(24)*	670.17	0.306E-22	R(57) A	27	2760.549 73(40)*	1216.79	0.272E-23	R(77) A
8	2753.840 56(25)*	693.67	0.277E-22	R(58) A	28	2760.897 66(45)*	1248.35	0.235E-23	R(78) A
9	2754.198 63(25)*	717.57	0.251E-22	R(59) A	29	2761.245 09(52)*	1280.32	0.203E-23	R(79) A
10	2754.556 12(25)*	741.87	0.226E-22	R(60) A	30	2761.592 02(59)*	1312.69	0.175E-23	R(80) A
11	2754.913 02(25)*	766.58	0.203E-22	R(61) A	31	2761.938 45(67)*	1345.46	0.150E-23	R(81) A
12	2755.269 35(25)*	791.70	0.182E-22	R(62) A	32	2762.284 37(77)*	1378.63	0.129E-23	R(82) A
13	2755.625 11(25)*	817.21	0.163E-22	R(63) A	33	2762.629 79(88)*	1412.21	0.110E-23	R(83) A
14	2755.980 31(25)*	843.13	0.146E-22	R(64) A	34	2762.974 7	1446.18	0.943E-24	R(84) A
15	2756.334 96(25)*	869.46	0.130E-22	R(65) A					
16	2756.689 06(25)*	896.18	0.115E-22	R(66) A					
17	2757.042 63(25)*	923.31	0.102E-22	R(67) A					
18	2757.395 66(25)*	950.85	0.906E-23	R(68) A					
19	2757.748 17(25)*	978.78	0.799E-23	R(69) A					
20	2758.100 15(26)*	1007.13	0.704E-23	R(70) A					

ATLAS OF OCS ABSORPTION LINES FROM 2862 cm⁻¹ to 2970 cm⁻¹

key:

Band	Isotopomer	Vibrational Transition
A	¹⁶ O ¹² C ³² S	10 ⁰ 1-00 ⁰ 0
B		11 ¹ 1-01 ^{1e} 0
C		11 ¹ 1-01 ^{1f} 0
D		10 ⁰ 2-00 ⁰ 1
E		12 ² 1-02 ^{2e} 0
F		12 ² 1-02 ^{2f} 0
G		12 ⁰ 1-02 ⁰ 0
H		11 ¹ 2-01 ^{1e} 1
I		11 ¹ 2-01 ^{1f} 1
W		04 ⁰ 1-00 ⁰ 0
X		04 ⁰ 2-00 ⁰ 1
Y		05 ¹ 1-01 ^{1e} 0
Z		05 ¹ 1-01 ^{1f} 0
K	¹⁸ O ¹² C ³² S	10 ⁰ 1-00 ⁰ 0
L	¹⁶ O ¹² C ³³ S	10 ⁰ 1-00 ⁰ 0
P	¹⁶ O ¹² C ³⁴ S	10 ⁰ 1-00 ⁰ 0
Q		11 ¹ 0-01 ^{1e} 0
R		11 ¹ 0-01 ^{1f} 0
T	¹⁶ O ¹³ C ³² S	10 ⁰ 1-00 ⁰ 0

If the e or f designation is not specified (for $l \neq 0$), then the transition is to either level, depending on the selection rules and the change in the rotational quantum number, J . Spectra are given for a slitwidth of 0.003 cm⁻¹ and a temperature of 296 K. The $\Delta v_1=1, \Delta v_3=1$ transitions (except for the D band) were calculated with assumed transition moments of 0.034 debye, the W band was calculated for a transition moment of 0.0036 debye, and the Y and Z bands were calculated with assumed transition moments of 0.0025 debye. No Herman-Wallis constant was included in the intensity calculation except for the D and X bands which are in resonance. For the D band a transition moment of 0.031 debye was used with a Herman-Wallis constant of $a_3 = -0.00034$. For the X band the transition moment was 0.0146 debye and the Herman-Wallis constant was $a_3 = 0.00105$.

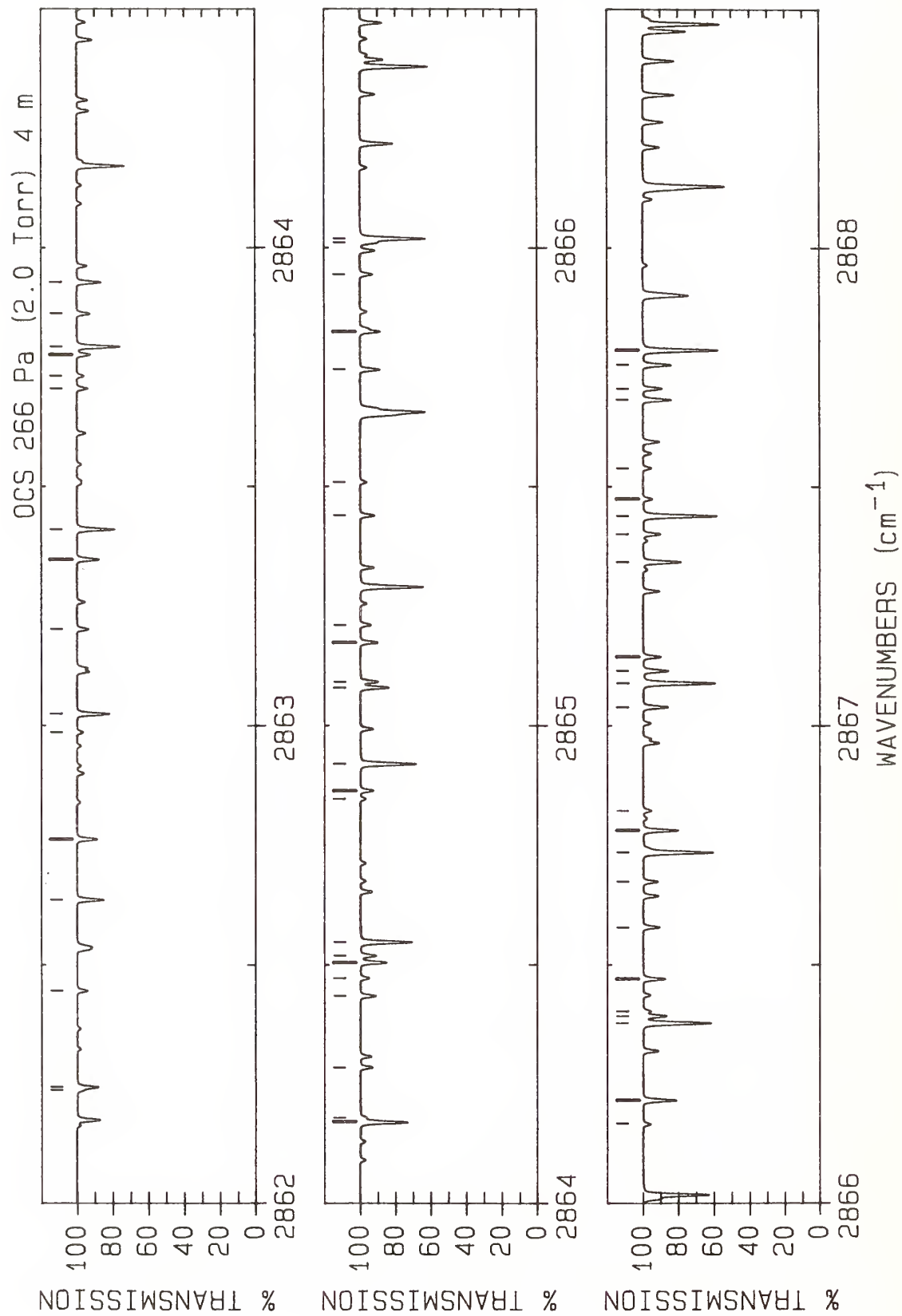

LINE #	WAVENUMBER(unc) (cm ⁻¹)	LOWER STATE (cm ⁻¹)	INTENSITY (cm/molecule)	ASSIGNMENT ROTATION BAND	LINE #	WAVENUMBER(unc) (cm ⁻¹)	LOWER STATE (cm ⁻¹)	INTENSITY (cm/molecule)	ASSIGNMENT ROTATION BAND
1	2862.237 10(50)	1924.43	0.892E-23	P(97) A	36	2865.209 47(38)	1770.05	0.181E-22	P(93) A
2	2862.244 14(31)	1.21	0.349E-22	R(2) T	37	2865.438 96(26)	1586.42	0.244E-22	P(51) G
3	2862.445 78(38)	1738.67	0.175E-22	P(77) B	38	2865.508 71(57)	1187.08	0.110E-22	P(77) P
4	2862.635 91(30)	2.43	0.462E-22	R(3) T	39	2865.744 03(28)	1586.72	0.343E-22	P(72) B
5	2862.762 37(39)	1667.76	0.177E-22	P(55) E	40	2865.823 67(28)	1587.83	0.341E-22	P(72) C
6	2862.763 38(40)	1667.83	0.176E-22	P(55) F	41	2865.943 40(37)	1732.46	0.215E-22	P(92) A
7	2862.985 71(45)	1885.23	0.107E-22	P(96) A	42	2866.010 48(23)	1565.68	0.264E-22	P(50) G
8	2863.024 53(29)	4.04	0.573E-22	R(4) T	43	2866.018 80(22)	31.54	0.131E-21	R(12) T
9	2863.200 56(35)	1708.71	0.200E-22	P(76) C	44	2866.167 37(49)	1156.68	0.126E-22	P(76) P
10	2863.346 42(35)	1645.40	0.193E-22	P(54) E	45	2866.217 05(23)	1539.70	0.293E-22	P(49) E
11	2863.347 28(35)	1645.47	0.193E-22	P(54) F	46	2866.217 32(23)	1539.75	0.293E-22	P(49) F
12	2863.409 97(29)	6.07	0.681E-22	R(5) T	47	2866.378 65(21)	36.80	0.137E-21	R(13) T
13	2863.704 52(37)	1651.06	0.188E-22	P(54) G	48	2866.393 32(27)	1557.54	0.390E-22	P(71) B
14	2863.730 64(42)	1846.44	0.128E-22	P(95) A	49	2866.403 43(96)	1086.39	0.124E-22	P(53) Q
15	2863.775 45(32)	1676.68	0.230E-22	P(75) B	50	2866.470 82(27)	1558.62	0.388E-22	P(71) C
16	2863.792 23(28)	8.49	0.785E-22	R(6) T	51	2866.578 69(22)	1545.35	0.286E-22	P(49) G
17	2863.861 52(32)	1677.89	0.229E-22	P(75) C	52	2866.673 68(36)	1695.27	0.255E-22	P(91) A
18	2863.927 17(32)	1623.45	0.211E-22	P(53) E	53	2866.735 27(21)	42.46	0.143E-21	R(14) T
19	2863.927 89(32)	1623.51	0.211E-22	P(53) F	54	2866.781 26(22)	1519.78	0.316E-22	P(48) E
20	2864.171 32(27)	11.32	0.885E-22	R(7) T	55	2866.781 44(22)	1519.82	0.316E-22	P(48) F
21	2864.181 09(78)	1249.06	0.836E-23	P(79) P	56	2866.822 59(42)	1126.67	0.144E-22	P(75) P
22	2864.285 98(32)	1629.11	0.206E-22	P(53) G	57	2867.039 14(26)	1528.76	0.442E-22	P(70) B
23	2864.435 10(30)	1646.29	0.264E-22	P(74) B	58	2867.088 63(20)	48.53	0.148E-21	R(15) T
24	2864.471 89(39)	1808.05	0.152E-22	P(94) A	59	2867.114 53(26)	1529.81	0.440E-22	P(70) C
25	2864.504 60(29)	1601.90	0.230E-22	P(52) E	60	2867.143 59(20)	1525.43	0.309E-22	P(48) G
26	2864.505 19(29)	1601.96	0.230E-22	P(52) F	61	2867.342 17(21)	1500.26	0.341E-22	P(47) E
27	2864.519 02(31)	1647.46	0.262E-22	P(74) C	62	2867.342 27(21)	1500.30	0.341E-22	P(47) F
28	2864.547 22(26)	14.56	0.980E-22	R(8) T	63	2867.400 32(36)	1658.48	0.302E-22	P(90) A
29	2864.846 61(67)	1217.87	0.961E-23	P(78) P	64	2867.438 74(20)	55.00	0.152E-21	R(16) T
30	2864.864 13(29)	1607.56	0.224E-22	P(52) G	65	2867.474 35(35)	1097.06	0.164E-22	P(74) P
31	2864.919 93(25)	18.20	0.107E-21	R(9) T	66	2867.539 07(71)	1044.83	0.146E-22	P(51) Q
32	2865.078 72(26)	1580.76	0.250E-22	P(51) E	67	2867.681 51(26)	1500.39	0.500E-22	P(69) B
33	2865.079 20(26)	1580.82	0.250E-22	P(51) F	68	2867.705 18(20)	1505.91	0.332E-22	P(47) G
34	2865.091 30(29)	1616.30	0.301E-22	P(73) B	69	2867.754 78(26)	1501.41	0.497E-22	P(69) C
35	2865.173 07(29)	1617.44	0.299E-22	P(73) C	70	2867.785 57(20)	61.87	0.156E-21	R(17) T

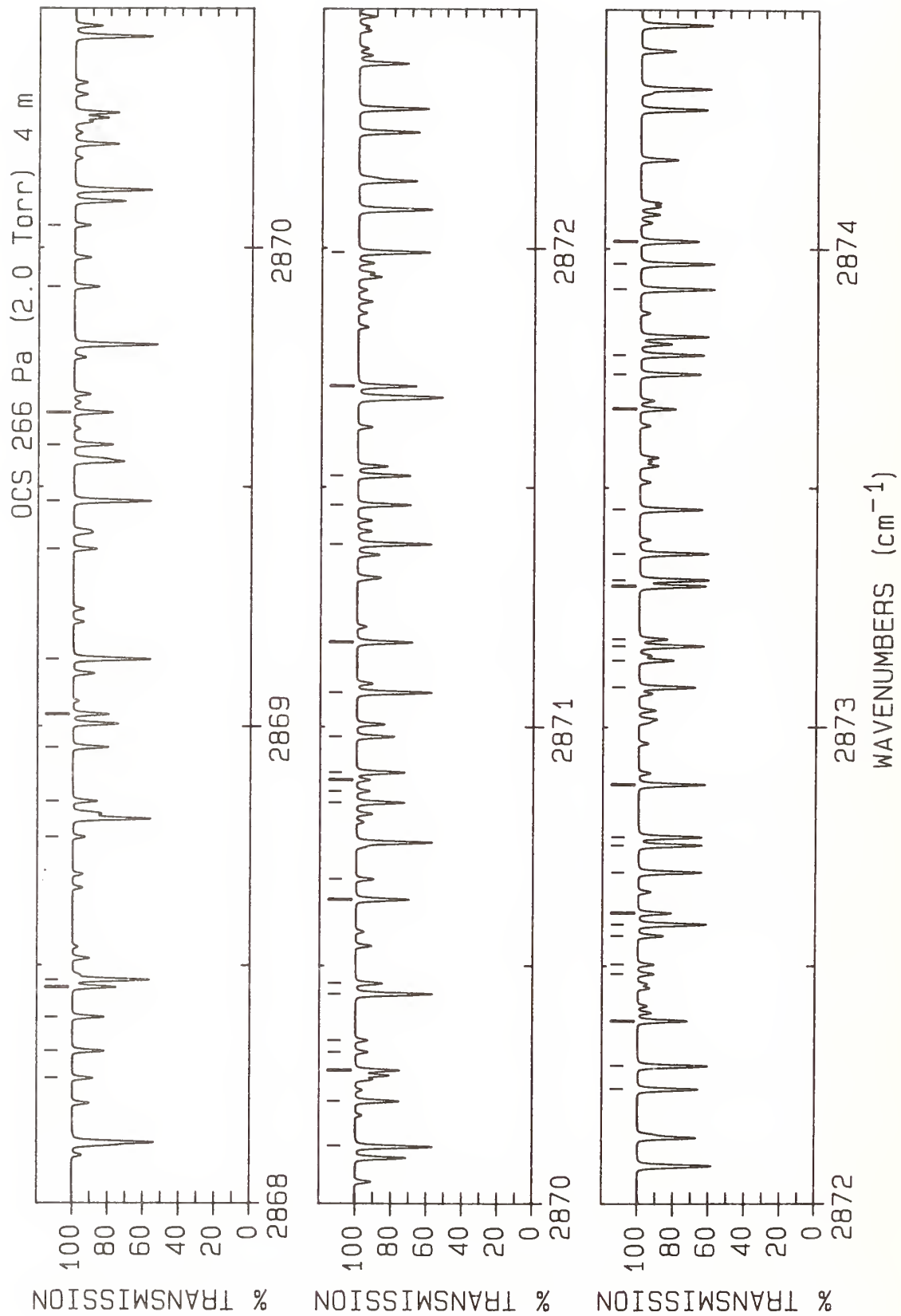

LINE #	WAVENUMBER(unc) (cm ⁻¹)	LOWER STATE (cm ⁻¹)	INTENSITY (cm/molecule)	ASSIGNMENT ROTATION BAND	LINE #	WAVENUMBER(unc) (cm ⁻¹)	LOWER STATE (cm ⁻¹)	INTENSITY (cm/molecule)	ASSIGNMENT ROTATION BAND
1	2868.263 47(19)	1486.80	0.357E-22	P(46) G	36	2871.381 42(26)	164.16	0.153E-21	R(28) T
2	2868.320 43(25)	1472.41	0.565E-22	P(68) B	37	2871.463 21(24)	1338.62	0.100E-21	P(63) B
3	2868.391 59(26)	1473.41	0.562E-22	P(68) C	38	2871.524 05(24)	1339.47	0.999E-22	P(63) C
4	2868.454 06(20)	1462.47	0.392E-22	P(45) F	39	2871.710 59(20)	1358.74	0.563E-22	P(39) F
5	2868.454 09(20)	1462.44	0.392E-22	P(45) E	40	2871.710 84(20)	1358.72	0.563E-22	P(39) E
6	2868.469 39(21)	76.83	0.161E-21	R(19) T	41	2871.991 19(27)	188.01	0.146E-21	R(30) T
7	2868.767 48(26)	1039.01	0.212E-22	P(72) P	42	2872.241 86(20)	1342.87	0.593E-22	P(38) F
8	2868.842 70(35)	1586.11	0.420E-22	P(88) A	43	2872.242 13(20)	1342.85	0.593E-22	P(38) E
9	2868.955 89(25)	1444.85	0.636E-22	P(67) B	44	2872.290 90(27)	200.54	0.142E-21	R(31) T
10	2869.024 96(25)	1445.81	0.633E-22	P(67) C	45	2872.385 30(33)	1412.21	0.923E-22	P(83) A
11	2869.139 99(22)	93.41	0.164E-21	R(21) T	46	2872.483 90(38)	877.36	0.272E-22	P(42) Q
12	2869.370 12(19)	1449.79	0.409E-22	P(44) G	47	2872.503 66(42)	877.73	0.271E-22	P(42) R
13	2869.470 29(22)	102.30	0.164E-21	R(22) T	48	2872.563 28(17)	874.29	0.433E-22	P(66) P
14	2869.587 90(25)	1417.69	0.715E-22	P(66) B	49	2872.587 15(27)	213.48	0.137E-21	R(32) T
15	2869.654 89(25)	1418.62	0.712E-22	P(66) C	50	2872.610 85(19)	1348.52	0.578E-22	P(38) G
16	2869.918 49(19)	1431.90	0.436E-22	P(43) G	51	2872.696 17(24)	1287.93	0.124E-21	P(61) B
17	2870.046 70(20)	982.53	0.271E-22	P(70) P	52	2872.752 98(24)	1288.73	0.124E-21	P(61) C
18	2870.120 86(24)	121.31	0.162E-21	R(24) T	53	2872.769 85(19)	1327.41	0.622E-22	P(37) F
19	2870.216 46(25)	1390.93	0.803E-22	P(65) B	54	2872.770 14(19)	1327.39	0.622E-22	P(37) E
20	2870.281 38(25)	1391.83	0.799E-22	P(65) C	55	2872.879 91(27)	226.82	0.132E-21	R(33) T
21	2870.319 62(38)	947.84	0.211E-22	P(46) Q	56	2873.082 99(33)	1378.63	0.107E-21	P(82) A
22	2870.344 21(55)	948.28	0.211E-22	P(46) R	57	2873.139 42(18)	1333.06	0.607E-22	P(37) G
23	2870.441 09(25)	131.41	0.161E-21	R(25) T	58	2873.169 17(27)	240.56	0.128E-21	R(34) T
24	2870.463 56(19)	1414.41	0.464E-22	P(42) G	59	2873.183 68(17)	848.22	0.484E-22	P(65) P
25	2870.638 21(20)	1391.69	0.504E-22	P(41) F	60	2873.294 57(19)	1312.36	0.651E-22	P(36) F
26	2870.638 41(20)	1391.67	0.504E-22	P(41) E	61	2873.294 86(19)	1312.34	0.651E-22	P(36) E
27	2870.681 09(19)	954.88	0.306E-22	P(69) P	62	2873.307 47(24)	1263.19	0.138E-21	P(60) B
28	2870.841 56(24)	1364.57	0.898E-22	P(64) B	63	2873.362 30(24)	1263.97	0.138E-21	P(60) C
29	2870.865 70(36)	929.63	0.226E-22	P(45) Q	64	2873.454 93(27)	254.71	0.122E-21	R(35) T
30	2870.889 06(49)	930.05	0.225E-22	P(45) R	65	2873.664 71(18)	1318.01	0.636E-22	P(36) G
31	2870.904 43(25)	1365.45	0.895E-22	P(64) C	66	2873.737 17(27)	269.26	0.117E-21	R(36) T
32	2870.979 10(34)	1480.56	0.678E-22	P(85) A	67	2873.777 06(32)	1345.46	0.125E-21	P(81) A
33	2871.071 39(26)	152.84	0.156E-21	R(27) T	68	2873.915 33(23)	1238.86	0.153E-21	P(59) B
34	2871.176 04(20)	1375.01	0.534E-22	P(40) F	69	2873.968 20(23)	1239.61	0.152E-21	P(59) C
35	2871.176 27(20)	1374.99	0.534E-22	P(40) E	70	2874.015 87(27)	284.21	0.112E-21	R(37) T

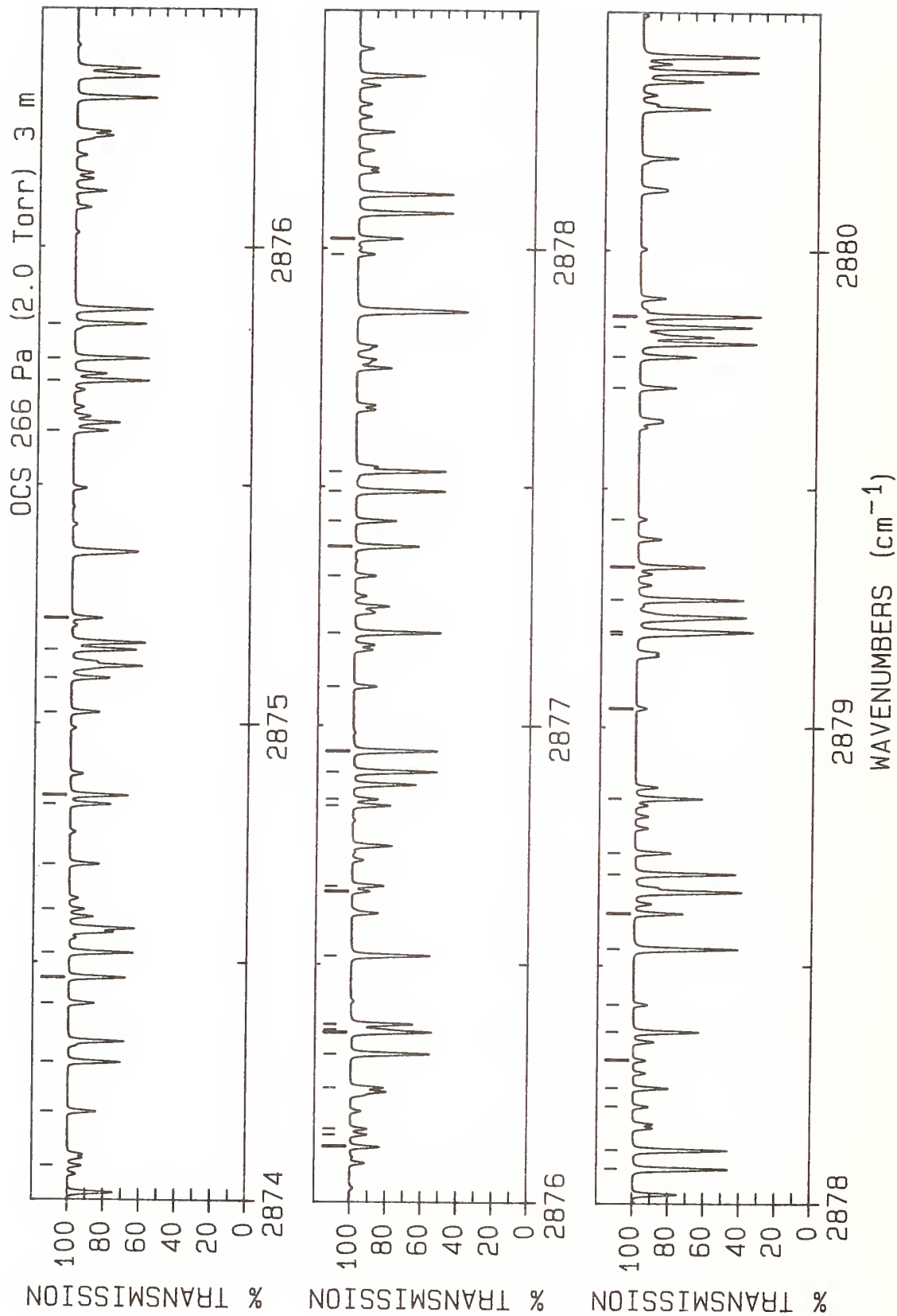

LINE #	WAVENUMBER(unc) (cm ⁻¹)	LOWER STATE (cm ⁻¹)	INTENSITY (cm/molecule)	ASSIGNMENT ROTATION BAND	LINE #	WAVENUMBER(unc) (cm ⁻¹)	LOWER STATE (cm ⁻¹)	INTENSITY (cm/molecule)	ASSIGNMENT ROTATION BAND
1	2874.072 06(41)	828.65	0.320E-22	P(39) Q	36	2877.081 31(38)	495.14	0.529E-22	R(49) T
2	2874.186 69(18)	1303.37	0.664E-22	P(35) G	37	2877.193 42(30)	1185.63	0.255E-21	P(76) A
3	2874.291 03(27)	299.57	0.107E-21	R(38) T	38	2877.313 32(38)	515.34	0.489E-22	R(50) T
4	2874.413 95(17)	797.25	0.602E-22	P(63) P	39	2877.374 48(15)	1206.55	0.846E-22	P(28) F
5	2874.467 54(31)	1312.69	0.145E-21	P(80) A	40	2877.374 74(15)	1206.55	0.846E-22	P(28) E
6	2874.519 75(23)	1214.93	0.169E-21	P(58) B	41	2877.428 18(16)	676.72	0.996E-22	P(58) P
7	2874.610 00(44)	813.51	0.336E-22	P(38) R	42	2877.490 16(22)	1101.34	0.268E-21	P(53) B
8	2874.705 39(17)	1289.13	0.691E-22	P(34) G	43	2877.531 71(22)	1101.95	0.267E-21	P(53) C
9	2874.830 68(28)	331.50	0.961E-22	R(40) T	44	2877.987 66(37)	578.35	0.381E-22	R(53) T
10	2874.849 07(18)	1269.63	0.735E-22	P(33) F	45	2878.020 49(16)	653.80	0.109E-21	P(57) P
11	2874.849 37(18)	1269.62	0.735E-22	P(33) E	46	2878.073 92(22)	1079.84	0.292E-21	P(52) B
12	2875.023 82(17)	772.36	0.668E-22	P(62) P	47	2878.113 68(22)	1080.42	0.291E-21	P(52) C
13	2875.095 14(29)	348.07	0.908E-22	R(41) T	48	2878.205 23(36)	600.16	0.350E-22	R(54) T
14	2875.154 41(31)	1280.32	0.167E-21	P(79) A	49	2878.244 10(16)	1200.85	0.844E-22	P(27) G
15	2875.220 79(17)	1275.30	0.717E-22	P(33) G	50	2878.302 43(46)	1613.69	0.284E-22	P(34) I
16	2875.613 32(31)	382.42	0.805E-22	R(43) T	51	2878.361 77(14)	1184.17	0.876E-22	P(26) F
17	2875.718 24(23)	1168.28	0.204E-21	P(56) B	52	2878.362 00(14)	1184.17	0.876E-22	P(26) E
18	2875.765 34(23)	1168.96	0.204E-21	P(56) C	53	2878.419 20(35)	622.38	0.320E-22	R(55) T
19	2875.837 68(30)	1248.35	0.193E-21	P(78) A	54	2878.534 75(29)	1124.52	0.334E-21	P(74) A
20	2876.117 09(34)	418.38	0.707E-22	R(45) T	55	2878.609 28(15)	631.27	0.120E-21	P(56) P
21	2876.142 90(43)	769.25	0.384E-22	P(35) Q	56	2878.692 23(22)	1059.31	0.317E-21	P(51) C
22	2876.154 99(46)	769.50	0.383E-22	P(35) R	57	2878.736 48(16)	1189.87	0.857E-22	P(26) G
23	2876.241 72(16)	1248.86	0.767E-22	P(31) G	58	2878.850 51(14)	1173.59	0.886E-22	P(25) F
24	2876.312 32(23)	1145.56	0.224E-21	P(55) B	59	2878.850 73(14)	1173.59	0.887E-22	P(25) E
25	2876.357 54(23)	1146.22	0.224E-21	P(55) C	60	2879.039 67(40)	691.43	0.241E-22	R(58) T
26	2876.363 57(35)	436.96	0.660E-22	R(46) T	61	2879.194 56(15)	609.13	0.131E-21	P(55) P
27	2876.374 13(16)	1230.57	0.807E-22	P(30) F	62	2879.200 01(28)	1094.57	0.381E-21	P(73) A
28	2876.374 41(16)	1230.56	0.807E-22	P(30) E	63	2879.267 38(22)	1038.59	0.343E-21	P(50) C
29	2876.517 35(30)	1216.79	0.222E-21	P(77) A	64	2879.335 99(14)	1163.41	0.894E-22	P(24) F
30	2876.652 28(43)	755.38	0.399E-22	P(34) Q	65	2879.336 19(14)	1163.41	0.894E-22	P(24) E
31	2876.663 38(46)	755.63	0.398E-22	P(34) R	66	2879.435 57(58)	739.49	0.197E-22	R(60) T
32	2876.832 36(16)	700.04	0.905E-22	P(59) P	67	2879.711 37(17)	1169.12	0.876E-22	P(24) G
33	2876.845 68(37)	475.34	0.571E-22	R(48) T	68	2879.776 33(15)	587.39	0.143E-21	P(54) P
34	2876.902 96(23)	1123.25	0.245E-21	P(54) B	69	2879.839 12(22)	1018.28	0.371E-21	P(49) C
35	2876.946 34(23)	1123.88	0.245E-21	P(54) C	70	2879.861 68(28)	1065.02	0.434E-21	P(72) A

OCS 266 Pa (2.0 Torr) 2 m

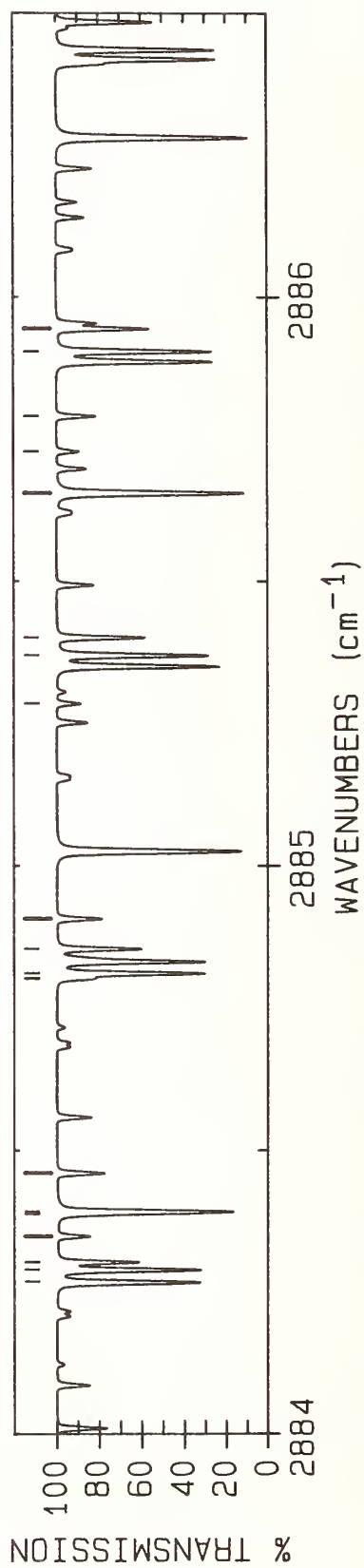
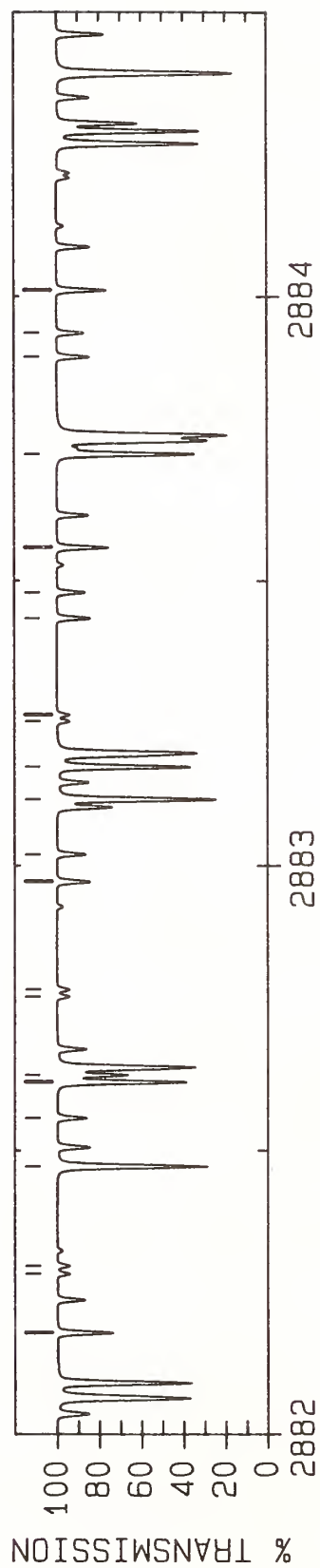
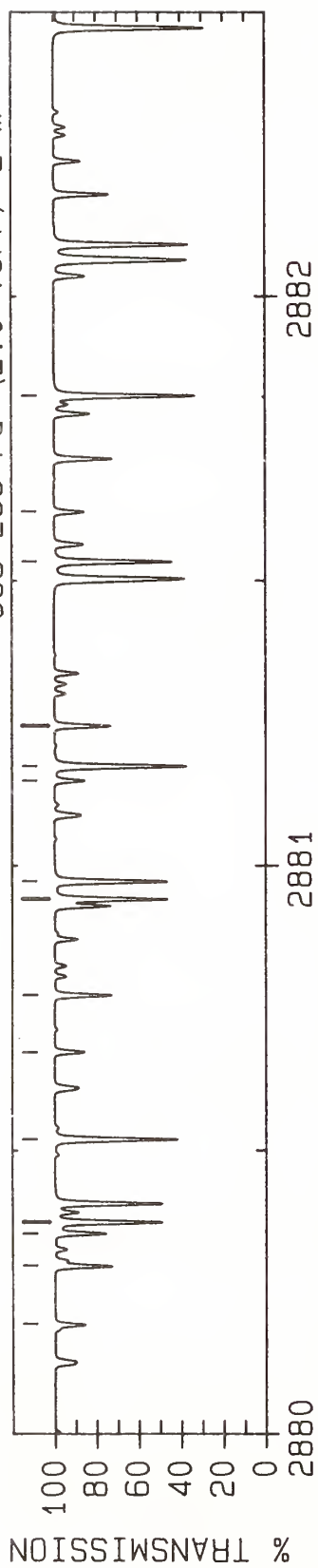

LINE #	WAVENUMBER(unc) (cm ⁻¹)	LOWER STATE (cm ⁻¹)	INTENSITY (cm/molecule)	ASSIGNMENT ROTATION BAND	LINE #	WAVENUMBER(unc) (cm ⁻¹)	LOWER STATE (cm ⁻¹)	INTENSITY (cm/molecule)	ASSIGNMENT ROTATION BAND
1	2880.193 89(17)	1159.35	0.880E-22	P(23) G	36	2883.434 10(31)	602.87	0.493E-22	P(20) Q
2	2880.297 15(14)	1144.28	0.898E-22	P(22) F	37	2883.434 80(31)	602.95	0.492E-22	P(20) R
3	2880.297 32(14)	1144.28	0.898E-22	P(22) E	38	2883.479 55(23)	1102.39	0.808E-22	P(16) G
4	2880.354 58(15)	566.04	0.156E-21	P(53) P	39	2883.558 41(17)	1090.14	0.790E-22	P(15) F
5	2880.374 60(22)	997.88	0.402E-21	P(48) B	40	2883.558 48(17)	1090.14	0.790E-22	P(15) E
6	2880.519 74(28)	1035.87	0.493E-21	P(71) A	41	2883.722 68(21)	887.08	0.603E-21	P(42) B
7	2880.673 12(18)	1149.99	0.881E-22	P(22) G	42	2883.893 57(31)	594.94	0.486E-22	P(19) Q
8	2880.772 84(14)	1135.33	0.895E-22	P(21) F	43	2883.893 82(31)	595.02	0.486E-22	P(19) R
9	2880.772 99(14)	1135.33	0.895E-22	P(21) E	44	2883.935 79(24)	1095.88	0.782E-22	P(15) G
10	2880.941 19(22)	978.40	0.433E-21	P(47) B	45	2884.011 25(18)	1084.04	0.758E-22	P(14) F
11	2880.972 40(22)	978.88	0.432E-21	P(47) C	46	2884.011 31(18)	1084.04	0.758E-22	P(14) E
12	2881.149 07(19)	1141.04	0.879E-22	P(21) G	47	2884.268 70(21)	870.04	0.640E-21	P(41) B
13	2881.174 21(27)	1007.13	0.560E-21	P(70) A	48	2884.290 71(21)	870.40	0.638E-21	P(41) C
14	2881.245 26(15)	1126.78	0.888E-22	P(20) F	49	2884.304 20(14)	427.66	0.266E-21	P(46) P
15	2881.245 39(15)	1126.78	0.888E-22	P(20) E	50	2884.349 55(31)	587.48	0.478E-22	P(18) R
16	2881.533 94(22)	959.78	0.463E-21	P(46) C	51	2884.349 72(32)	587.41	0.478E-22	P(18) Q
17	2881.621 73(20)	1132.50	0.872E-22	P(20) G	52	2884.388 75(25)	1089.77	0.752E-22	P(14) G
18	2881.825 07(27)	978.78	0.633E-21	P(69) A	53	2884.392 53(27)	869.46	0.102E-20	P(65) A
19	2882.180 31(16)	1110.91	0.861E-22	P(18) F	54	2884.460 83(19)	1078.34	0.721E-22	P(13) F
20	2882.180 42(16)	1110.90	0.861E-22	P(18) E	55	2884.460 88(19)	1078.34	0.721E-22	P(13) E
21	2882.284 19(42)	1514.62	0.352E-22	P(26) H	56	2884.802 00(31)	580.35	0.467E-22	P(17) R
22	2882.298 03(40)	1514.78	0.352E-22	P(26) I	57	2884.802 54(32)	580.28	0.467E-22	P(17) Q
23	2882.472 34(27)	950.85	0.715E-21	P(68) A	58	2884.811 29(21)	853.39	0.677E-21	P(40) B
24	2882.557 21(21)	1116.63	0.848E-22	P(18) G	59	2884.854 43(14)	409.47	0.284E-21	P(45) P
25	2882.620 36(22)	922.39	0.532E-21	P(44) B	60	2884.907 15(19)	1073.05	0.680E-22	P(12) F
26	2882.632 52(14)	484.60	0.214E-21	P(49) P	61	2884.907 18(19)	1073.05	0.680E-22	P(12) E
27	2882.770 34(41)	1504.09	0.356E-22	P(25) H	62	2885.284 82(27)	1078.78	0.680E-22	P(12) G
28	2882.782 78(39)	1504.24	0.356E-22	P(25) I	63	2885.369 70(21)	837.49	0.713E-21	P(39) C
29	2882.971 30(31)	611.19	0.497E-22	P(21) Q	64	2885.401 17(14)	391.68	0.303E-21	P(44) P
30	2882.972 50(32)	611.28	0.496E-22	P(21) R	65	2885.654 65(26)	817.21	0.127E-20	P(63) A
31	2883.020 02(22)	1109.30	0.830E-22	P(17) G	66	2885.727 93(28)	1073.90	0.639E-22	P(11) G
32	2883.116 00(27)	923.31	0.805E-21	P(67) A	67	2885.789 99(21)	1063.68	0.586E-22	P(10) F
33	2883.173 23(21)	904.54	0.567E-21	P(43) B	68	2885.790 01(21)	1063.68	0.586E-22	P(10) E
34	2883.253 20(40)	1493.97	0.359E-22	P(24) H	69	2885.904 12(21)	821.64	0.750E-21	P(38) C
35	2883.264 30(38)	1494.11	0.359E-22	P(24) I	70	2885.944 42(14)	374.27	0.322E-21	P(43) P

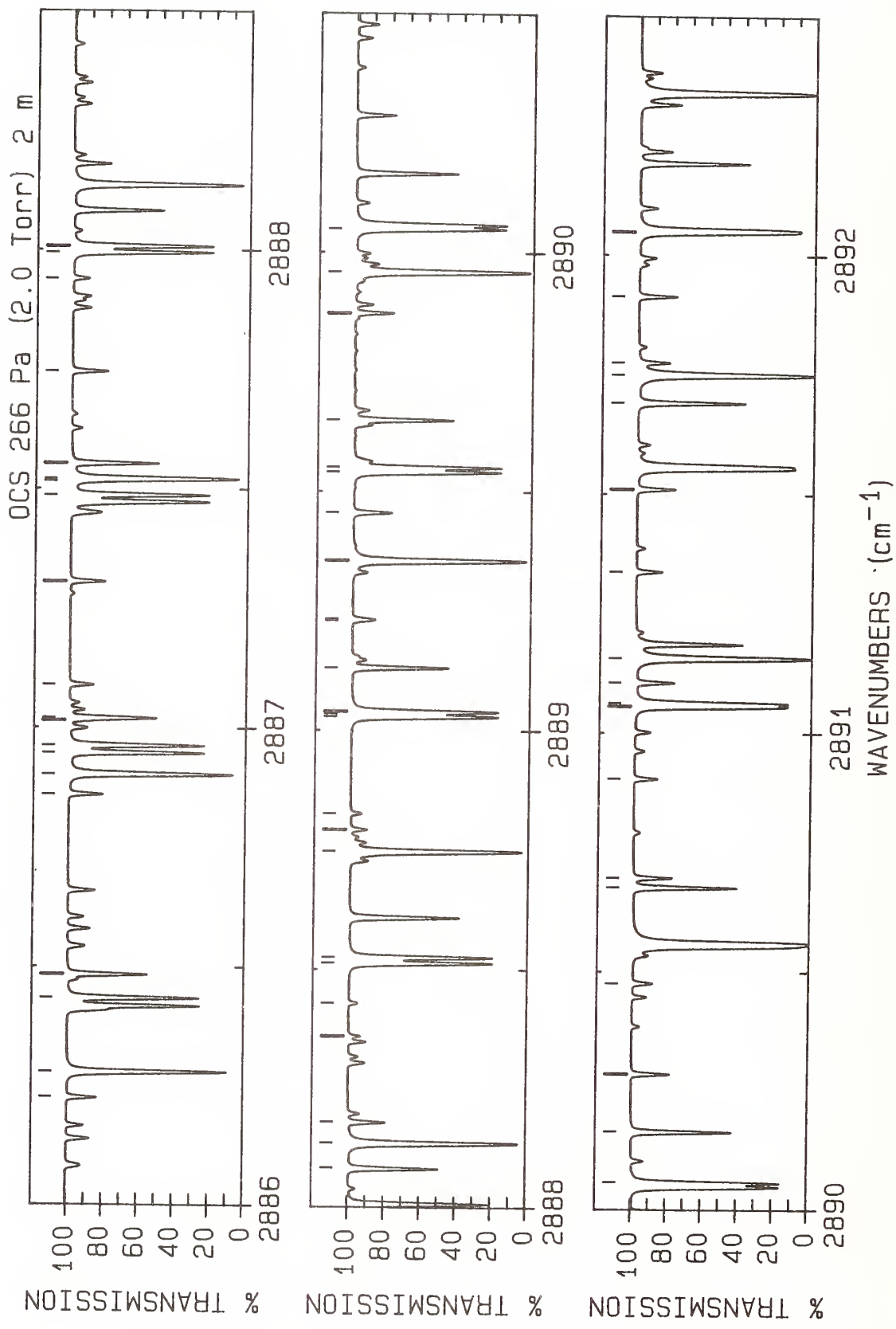

LINE #	WAVENUMBER(unc) (cm ⁻¹)	LOWER STATE (cm ⁻¹)	INTENSITY (cm/molecule)	ASSIGNMENT ROTATION BAND	LINE #	WAVENUMBER(unc) (cm ⁻¹)	LOWER STATE (cm ⁻¹)	INTENSITY (cm/molecule)	ASSIGNMENT ROTATION BAND	LINE #	WAVENUMBER(unc) (cm ⁻¹)	LOWER STATE (cm ⁻¹)	INTENSITY (cm/molecule)	ASSIGNMENT ROTATION BAND
1	2886.226 51(21)	1059.61	0.533E-22	P(9)	36	2888.792 52(43)	1404.09	0.277E-22	P(12)	I				
2	2886.226 53(21)	1059.61	0.533E-22	P(9)	37	2888.826 29(23)	1315.02	0.370E-22	P(47)	D				
3	2886.280 31(26)	791.70	0.142E-20	P(62)	38	2889.028 97(19)	734.85	0.964E-21	P(32)	B				
4	2886.435 16(20)	806.20	0.788E-21	P(37)	39	2889.034 78(15)	1143.24	0.135E-21	P(37)	X				
5	2886.484 18(14)	357.27	0.342E-21	P(42)	40	2889.039 68(19)	735.07	0.963E-21	P(32)	C				
6	2886.860 58(69)	1224.09	0.121E-21	P(42)	41	2889.130 81(14)	278.16	0.443E-21	P(37)	P				
7	2886.902 37(26)	766.58	0.157E-20	P(61)	42	2889.229 40(23)	1296.03	0.445E-22	P(46)	D				
8	2886.947 47(20)	790.88	0.826E-21	P(36)	43	2889.232 57(44)	1399.22	0.260E-22	P(11)	I				
9	2886.962 81(20)	791.16	0.825E-21	P(36)	44	2889.232 99(44)	1399.19	0.260E-22	P(11)	H				
10	2887.015 05(36)	550.60	0.380E-22	P(12)	45	2889.354 63(25)	670.17	0.235E-20	P(57)	A				
11	2887.016 81(37)	550.57	0.380E-22	P(12)	46	2889.455 72(21)	1128.29	0.137E-21	P(36)	X				
12	2887.020 46(14)	340.66	0.362E-21	P(41)	47	2889.540 81(19)	721.86	0.995E-21	P(31)	B				
13	2887.089 76(22)	1052.69	0.414E-22	P(7)	48	2889.550 47(19)	722.07	0.994E-21	P(31)	C				
14	2887.089 77(22)	1052.69	0.414E-22	P(7)	49	2889.649 73(14)	263.53	0.463E-21	P(36)	P				
15	2887.305 65(54)	1207.11	0.124E-21	P(41)	50	2889.872 84(22)	1113.73	0.138E-21	P(35)	X				
16	2887.487 09(20)	776.53	0.861E-21	P(35)	51	2889.958 70(25)	647.08	0.258E-20	P(56)	A				
17	2887.516 49(22)	1049.84	0.348E-22	P(6)	52	2890.049 23(19)	709.27	0.102E-20	P(30)	B				
18	2887.516 50(22)	1049.84	0.348E-22	P(6)	53	2890.057 88(19)	709.47	0.102E-20	P(30)	C				
19	2887.520 83(26)	741.87	0.174E-20	P(60)	54	2890.165 18(14)	249.29	0.482E-21	P(35)	P				
20	2887.553 26(14)	324.44	0.382E-21	P(40)	55	2890.286 50(23)	1099.58	0.139E-21	P(34)	X				
21	2887.745 37(40)	1190.54	0.128E-21	P(40)	56	2890.476 62(19)	1241.47	0.706E-22	P(43)	D				
22	2887.939 96(23)	1047.40	0.278E-22	P(5)	57	2890.677 16(13)	235.44	0.501E-21	P(34)	P				
23	2887.939 96(23)	1047.40	0.278E-22	P(5)	58	2890.697 06(22)	1085.84	0.140E-21	P(33)	X				
24	2887.995 05(20)	762.05	0.897E-21	P(34)	59	2890.904 16(17)	1224.09	0.806E-22	P(42)	D				
25	2888.008 00(20)	762.31	0.896E-21	P(34)	60	2891.055 85(18)	685.31	0.107E-20	P(28)	B				
26	2888.082 59(14)	308.62	0.402E-21	P(39)	61	2891.062 61(18)	685.49	0.107E-20	P(28)	C				
27	2888.135 70(26)	717.57	0.193E-20	P(59)	62	2891.104 88(22)	1072.49	0.140E-21	P(32)	X				
28	2888.179 94(26)	1174.37	0.130E-21	P(39)	63	2891.156 05(25)	602.10	0.310E-20	P(54)	A				
29	2888.360 15(23)	1045.36	0.200E-22	P(4)	64	2891.337 05(16)	1207.11	0.912E-22	P(41)	D				
30	2888.360 15(23)	1045.36	0.200E-22	P(4)	65	2891.510 30(23)	1059.56	0.140E-21	P(31)	X				
31	2888.429 74(23)	1334.42	0.303E-22	P(48)	66	2891.690 77(13)	208.93	0.537E-21	P(32)	P				
32	2888.513 72(19)	748.25	0.932E-21	P(33)	67	2891.749 34(25)	580.22	0.339E-20	P(53)	A				
33	2888.525 53(19)	748.49	0.931E-21	P(33)	68	2891.774 91(16)	1190.54	0.102E-21	P(40)	D				
34	2888.746 96(26)	693.67	0.213E-20	P(58)	69	2891.913 61(24)	1047.02	0.139E-21	P(30)	X				
35	2888.792 49(42)	1404.06	0.277E-22	P(12)	70	2892.048 83(18)	662.98	0.111E-20	P(26)	B				

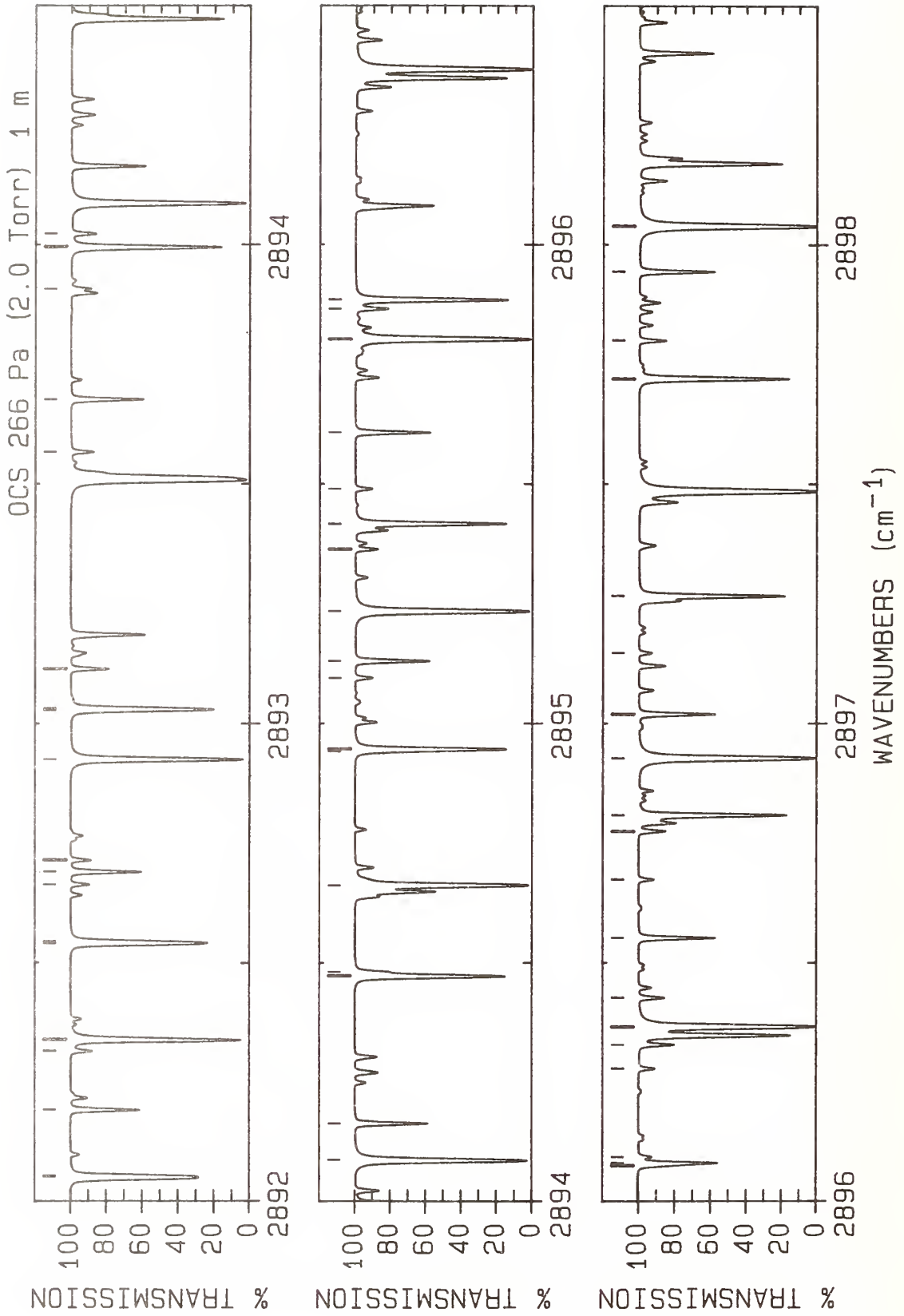

LINE #	WAVENUMBER(unc) (cm ⁻¹)	LOWER STATE (cm ⁻¹)	INTENSITY (cm/molecule)	ASSIGNMENT ROTATION BAND	LINE #	WAVENUMBER(unc) (cm ⁻¹)	LOWER STATE (cm ⁻¹)	INTENSITY (cm/molecule)	ASSIGNMENT ROTATION BAND
1	2892.048 83(18)	662.98	0.111E-20	P(26) B	36	2895.416 91(17)	597.60	0.112E-20	P(19) B
2	2892.053 87(18)	663.13	0.111E-20	P(26) C	37	2895.417 38(17)	597.68	0.112E-20	P(19) C
3	2892.192 40(13)	196.27	0.553E-21	P(31) P	38	2895.489 64(23)	952.40	0.117E-21	P(21) X
4	2892.315 12(26)	1034.89	0.138E-21	P(29) X	39	2895.607 45(11)	118.72	0.625E-21	P(24) P
5	2892.339 03(25)	558.74	0.369E-20	P(52) A	40	2895.801 84(24)	438.37	0.587E-20	P(46) A
6	2892.540 20(18)	652.42	0.112E-20	P(25) B	41	2895.865 73(16)	1059.56	0.219E-21	P(31) D
7	2892.544 45(18)	652.56	0.112E-20	P(25) C	42	2895.884 44(17)	589.88	0.110E-20	P(18) B
8	2892.663 78(16)	1158.61	0.126E-21	P(38) D	43	2895.884 45(17)	589.95	0.110E-20	P(18) C
9	2892.690 58(12)	184.01	0.568E-21	P(30) P	44	2896.076 09(16)	1090.14	0.848E-22	R(15) E
10	2892.715 08(27)	1023.17	0.137E-21	P(28) X	45	2896.076 27(16)	1090.14	0.848E-22	R(15) F
11	2892.925 14(25)	537.67	0.401E-20	P(51) A	46	2896.081 59(11)	109.23	0.627E-21	P(23) P
12	2893.028 17(17)	642.27	0.113E-20	P(24) B	47	2896.094 24(23)	1089.77	0.809E-22	R(14) G
13	2893.031 68(17)	642.40	0.113E-20	P(24) C	48	2896.279 19(24)	935.82	0.108E-21	P(19) X
14	2893.113 74(28)	1011.84	0.135E-21	P(27) X	49	2896.328 94(16)	1047.02	0.232E-21	P(30) D
15	2893.113 90(17)	1143.24	0.139E-21	P(37) D	50	2896.366 43(24)	419.73	0.628E-20	P(45) A
16	2893.567 19(17)	1128.29	0.152E-21	P(36) D	51	2896.427 35(16)	1096.66	0.875E-22	R(16) E
17	2893.676 61(12)	160.67	0.594E-21	P(28) P	52	2896.427 57(16)	1096.66	0.875E-22	R(16) F
18	2893.908 06(27)	990.41	0.131E-21	P(25) X	53	2896.552 30(11)	100.13	0.627E-21	P(22) P
19	2893.993 89(17)	623.18	0.114E-20	P(22) B	54	2896.674 04(25)	928.13	0.103E-21	P(18) X
20	2893.996 04(17)	623.29	0.114E-20	P(22) C	55	2896.775 30(15)	1103.58	0.897E-22	R(17) E
21	2894.023 21(17)	1113.73	0.165E-21	P(35) D	56	2896.775 57(15)	1103.58	0.897E-22	R(17) F
22	2894.086 57(24)	496.74	0.470E-20	P(49) A	57	2896.808 50(17)	575.72	0.104E-20	P(16) C
23	2894.164 47(12)	149.59	0.605E-21	P(27) P	58	2896.809 29(17)	575.66	0.104E-20	P(16) B
24	2894.471 63(17)	614.25	0.114E-20	P(21) B	59	2896.927 44(24)	401.49	0.671E-20	P(44) A
25	2894.473 18(17)	614.35	0.114E-20	P(21) C	60	2897.019 59(12)	91.42	0.625E-21	P(21) P
26	2894.481 50(16)	1099.58	0.179E-21	P(34) D	61	2897.146 81(20)	1109.30	0.883E-22	R(17) G
27	2894.661 91(24)	476.88	0.507E-20	P(48) A	62	2897.265 50(17)	569.22	0.101E-20	P(15) C
28	2894.941 62(16)	1085.84	0.192E-21	P(33) D	63	2897.266 61(17)	569.16	0.101E-20	P(15) B
29	2894.945 98(17)	605.72	0.113E-20	P(20) B	64	2897.719 09(15)	1011.84	0.268E-21	P(27) D
30	2894.946 96(17)	605.81	0.113E-20	P(20) C	65	2897.719 14(17)	563.12	0.971E-21	P(14) C
31	2895.094 74(24)	961.29	0.121E-21	P(22) X	66	2897.720 52(17)	563.07	0.971E-21	P(14) B
32	2895.129 89(12)	128.62	0.620E-21	P(25) P	67	2897.799 29(14)	1126.78	0.939E-22	R(20) E
33	2895.233 66(24)	457.42	0.546E-20	P(47) A	68	2897.799 73(14)	1126.78	0.939E-22	R(20) F
34	2895.363 67(17)	1078.34	0.782E-22	R(13) E	69	2897.943 92(12)	75.19	0.612E-21	P(19) P
35	2895.363 78(17)	1078.34	0.782E-22	R(13) F	70	2898.038 74(24)	366.22	0.761E-20	P(42) A

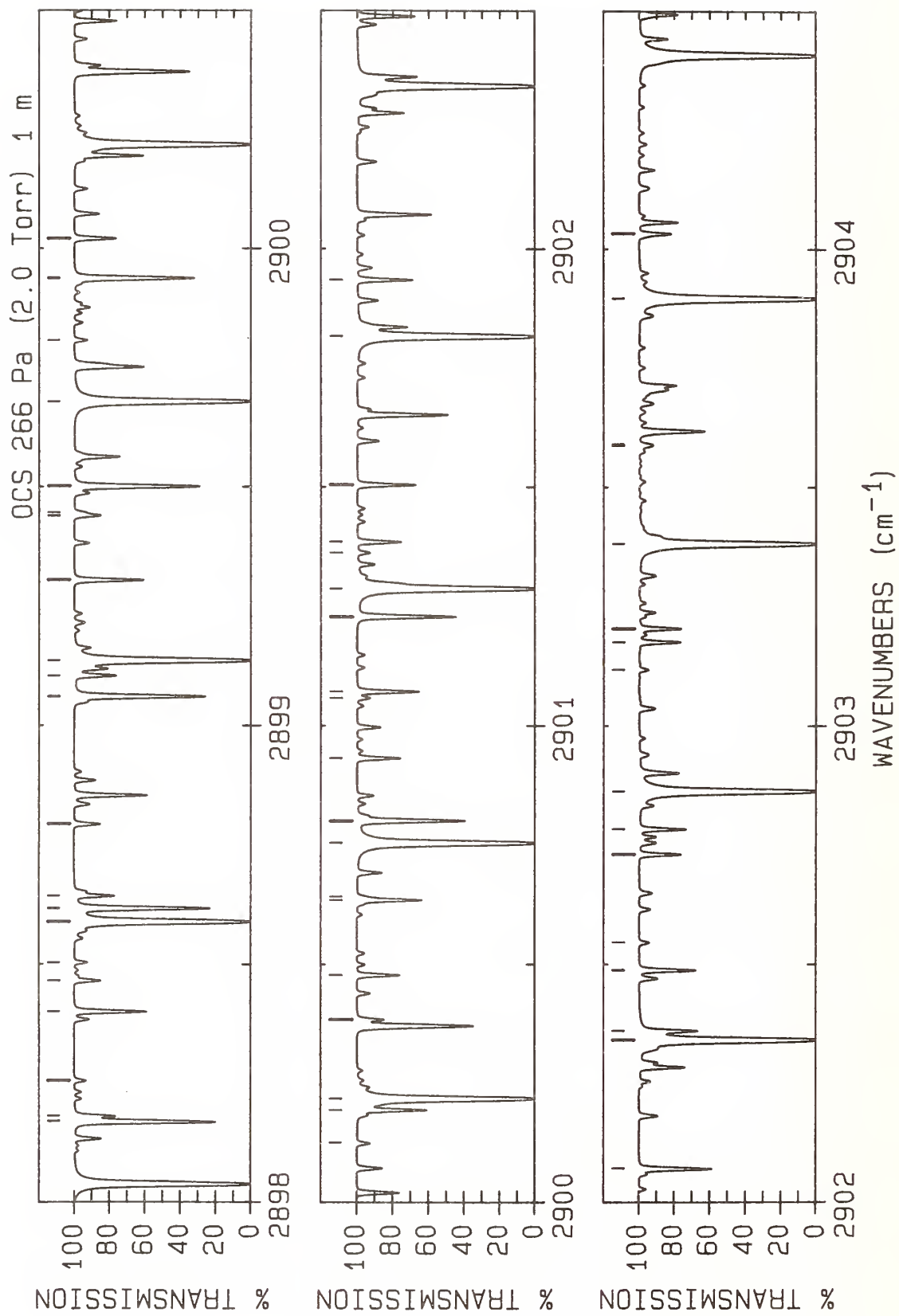

LINE #	WAVENUMBER(unc) (cm ⁻¹)	LOWER STATE (cm ⁻¹)	INTENSITY (cm/molecule)	ASSIGNMENT ROTATION BAND	LINE #	WAVENUMBER(unc) (cm ⁻¹)	LOWER STATE (cm ⁻¹)	INTENSITY (cm/molecule)	ASSIGNMENT ROTATION BAND
1	2898.169 42(17)	557.42	0.926E-21	P(13) C	36	2900.477 81(14)	952.40	0.313E-21	P(21) D
2	2898.169 53(18)	1132.50	0.921E-22	R(20) G	37	2900.635 05(14)	36.02	0.507E-21	P(13) P
3	2898.171 02(17)	557.38	0.926E-21	P(13) B	38	2900.641 97(49)	873.53	0.480E-22	P(8) X
4	2898.181 66(15)	1000.93	0.278E-21	P(26) D	39	2900.754 52(24)	285.13	0.995E-20	P(37) A
5	2898.255 86(26)	901.44	0.824E-22	P(14) X	40	2900.800 64(18)	531.81	0.557E-21	P(7) C
6	2898.400 97(12)	67.68	0.601E-21	P(18) P	41	2900.802 55(18)	531.80	0.557E-21	P(7) B
7	2898.465 36(14)	1144.28	0.946E-22	R(22) E	42	2900.932 43(14)	943.90	0.316E-21	P(20) D
8	2898.465 96(14)	1144.28	0.946E-22	R(22) F	43	2901.058 04(16)	1224.04	0.844E-22	R(29) G
9	2898.503 79(17)	1141.04	0.926E-22	R(21) G	44	2901.071 65(14)	30.87	0.480E-21	P(12) P
10	2898.589 03(24)	349.19	0.807E-20	P(41) A	45	2901.227 42(18)	528.96	0.481E-21	P(6) C
11	2898.616 34(17)	552.14	0.876E-21	P(12) C	46	2901.229 22(18)	528.95	0.481E-21	P(6) B
12	2898.618 12(17)	552.11	0.877E-21	P(12) B	47	2901.286 98(24)	270.13	0.104E-19	P(36) A
13	2898.643 40(15)	990.41	0.288E-21	P(25) D	48	2901.362 30(17)	1236.25	0.822E-22	R(30) G
14	2898.793 41(14)	1153.64	0.944E-22	R(23) E	49	2901.385 18(14)	935.82	0.317E-21	P(19) D
15	2898.794 10(14)	1153.64	0.944E-22	R(23) F	50	2901.504 85(14)	26.12	0.450E-21	P(11) P
16	2899.059 92(18)	547.26	0.822E-21	P(11) C	51	2901.815 89(24)	255.53	0.109E-19	P(35) A
17	2899.061 82(18)	547.23	0.822E-21	P(11) B	52	2901.934 64(15)	21.77	0.418E-21	P(10) P
18	2899.104 07(14)	980.30	0.296E-21	P(24) D	53	2902.070 93(18)	524.49	0.316E-21	P(4) C
19	2899.135 75(24)	332.57	0.854E-20	P(40) A	54	2902.072 32(18)	524.48	0.316E-21	P(4) B
20	2899.304 82(13)	53.83	0.572E-21	P(16) P	55	2902.341 25(24)	241.34	0.113E-19	P(34) A
21	2899.439 53(15)	1173.59	0.929E-22	R(25) E	56	2902.361 04(15)	17.81	0.384E-21	P(9) P
22	2899.440 42(15)	1173.59	0.929E-22	R(25) F	57	2902.487 64(18)	522.86	0.226E-21	P(3) C
23	2899.446 46(31)	885.66	0.655E-22	P(11) X	58	2902.488 76(18)	522.86	0.226E-21	P(3) B
24	2899.500 13(18)	542.79	0.762E-21	P(10) C	59	2902.545 87(18)	1289.13	0.718E-22	R(34) G
25	2899.502 11(18)	542.76	0.762E-21	P(10) B	60	2902.731 09(15)	913.98	0.309E-21	P(16) D
26	2899.678 90(24)	316.35	0.901E-20	P(39) A	61	2902.784 03(15)	14.25	0.347E-21	P(8) P
27	2899.807 58(16)	1179.29	0.909E-22	R(25) G	62	2902.863 06(24)	227.55	0.118E-19	P(33) A
28	2899.936 99(18)	538.72	0.698E-21	P(9) C	63	2903.117 52(19)	1318.01	0.660E-22	R(36) G
29	2899.939 00(18)	538.70	0.698E-21	P(9) B	64	2903.175 32(15)	907.50	0.302E-21	P(15) D
30	2900.021 45(14)	961.29	0.309E-21	P(22) D	65	2903.203 63(16)	11.08	0.308E-21	P(7) P
31	2900.125 20(16)	1189.87	0.897E-22	R(26) G	66	2903.381 31(24)	214.17	0.122E-19	P(32) A
32	2900.195 05(13)	41.56	0.531E-21	P(14) P	67	2903.587 14(20)	1358.72	0.584E-22	R(39) E
33	2900.218 49(24)	300.54	0.948E-20	P(38) A	68	2903.591 06(20)	1358.74	0.584E-22	R(39) F
34	2900.383 67(16)	1206.55	0.884E-22	R(28) E	69	2903.896 03(24)	201.19	0.126E-19	P(31) A
35	2900.384 97(16)	1206.55	0.884E-22	R(28) F	70	2904.032 62(16)	5.94	0.226E-21	P(5) P

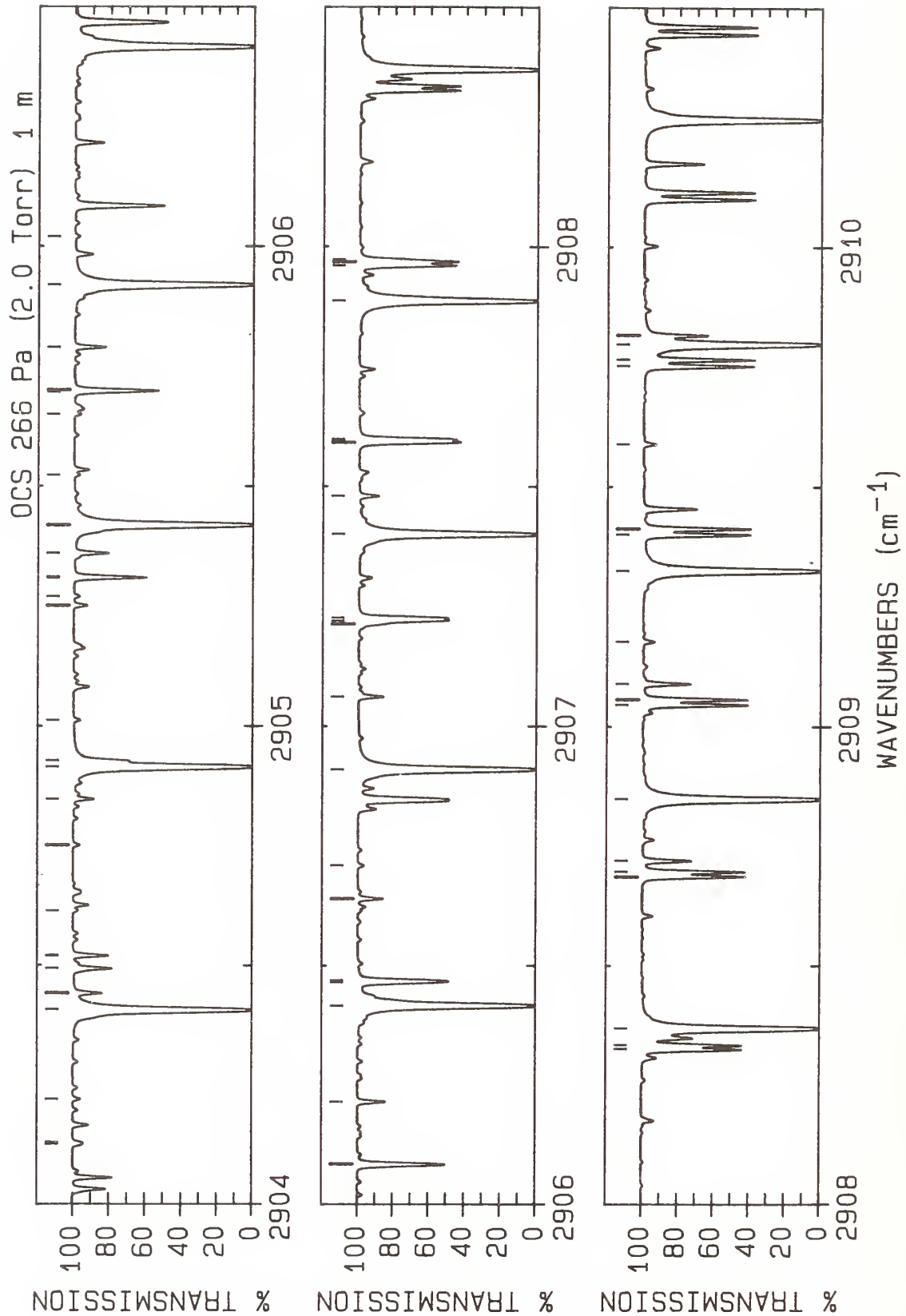

LINE #	WAVENUMBER(cm^{-1})	LOWER STATE (cm^{-1})	INTENSITY ($\text{cm}/\text{molecule}$)	ASSIGNMENT ROTATION BAND	LINE #	WAVENUMBER(unc) (cm^{-1})	LOWER STATE (cm^{-1})	INTENSITY ($\text{cm}/\text{molecule}$)	ASSIGNMENT ROTATION BAND
1	2904.125 68(20)	1391.67	0.523E-22	R(41) E	36	2906.709 37(49)	867.46	0.433E-22	R(6) X
2	2904.130 33(20)	1391.69	0.523E-22	R(41) F	37	2906.909 97(25)	131.84	0.142E-19	P(25) A
3	2904.220 47(19)	1380.65	0.540E-22	R(40) G	38	2907.061 33(15)	867.46	0.157E-21	P(6) D
4	2904.407 19(24)	188.62	0.129E-19	P(30) A	39	2907.062 38(53)	966.45	0.204E-22	R(47) Q
5	2904.442 02(16)	3.96	0.183E-21	P(4) P	40	2907.212 58(16)	1.19	0.139E-21	R(2) P
6	2904.493 70(14)	890.52	0.270E-21	P(12) D	41	2907.219 75(18)	535.04	0.712E-21	R(8) B
7	2904.519 79(18)	520.83	0.129E-21	R(1) B	42	2907.225 83(18)	535.06	0.712E-21	R(8) C
8	2904.520 79(18)	520.83	0.129E-21	R(1) C	43	2907.399 93(25)	121.70	0.143E-19	P(24) A
9	2904.614 08(43)	798.44	0.365E-22	R(37) R	44	2907.479 83(16)	865.03	0.132E-21	P(5) D
10	2904.751 72(19)	1414.41	0.480E-22	R(42) G	45	2907.591 77(18)	538.70	0.780E-21	R(9) B
11	2904.848 02(16)	2.38	0.138E-21	P(3) P	46	2907.594 75(16)	2.38	0.184E-21	R(3) P
12	2904.914 82(24)	176.45	0.133E-19	P(29) A	47	2907.598 78(18)	538.72	0.780E-21	R(9) C
13	2904.928 20(13)	885.66	0.255E-21	P(11) D	48	2907.886 36(25)	111.96	0.144E-19	P(23) A
14	2905.012 28(19)	1431.90	0.451E-22	R(43) G	49	2907.960 36(17)	542.76	0.843E-21	R(10) B
15	2905.250 61(17)	1.19	0.925E-22	P(2) P	50	2907.968 34(17)	542.79	0.842E-21	R(10) C
16	2905.269 45(19)	1449.79	0.423E-22	R(44) G	51	2907.973 53(16)	3.96	0.228E-21	R(4) P
17	2905.308 31(18)	522.86	0.319E-21	R(3) B	52	2908.325 52(17)	547.23	0.901E-21	R(11) B
18	2905.310 51(18)	522.86	0.319E-21	R(3) C	53	2908.334 53(17)	547.26	0.901E-21	R(11) C
19	2905.360 12(13)	881.21	0.239E-21	P(10) D	54	2908.369 27(25)	102.63	0.144E-19	P(22) A
20	2905.418 91(24)	164.69	0.135E-19	P(28) A	55	2908.687 25(17)	552.11	0.954E-21	R(12) B
21	2905.523 24(20)	1468.09	0.396E-22	R(45) G	56	2908.697 33(17)	552.14	0.954E-21	R(12) C
22	2905.649 81(17)	0.40	0.464E-22	P(1) P	57	2908.720 83(15)	8.31	0.313E-21	R(6) P
23	2905.695 95(46)	1599.65	0.307E-22	R(33) H	58	2908.848 66(25)	93.71	0.144E-19	P(21) A
24	2905.697 44(18)	524.48	0.405E-21	R(4) B	59	2909.045 55(17)	557.38	0.100E-20	R(13) B
25	2905.700 32(18)	524.49	0.405E-21	R(4) C	60	2909.056 75(17)	557.42	0.100E-20	R(13) C
26	2905.789 44(13)	877.17	0.221E-21	P(9) D	61	2909.089 37(15)	11.08	0.353E-21	R(7) P
27	2905.919 46(24)	153.34	0.138E-19	P(27) A	62	2909.176 58(26)	890.52	0.810E-22	R(12) X
28	2906.020 66(22)	1505.91	0.344E-22	R(47) G	63	2909.324 53(25)	85.19	0.143E-19	P(20) A
29	2906.083 15(18)	526.51	0.487E-21	R(5) B	64	2909.400 41(17)	563.07	0.104E-20	R(14) B
30	2906.086 75(18)	526.52	0.487E-21	R(5) C	65	2909.412 78(17)	563.12	0.104E-20	R(14) C
31	2906.216 10(14)	873.53	0.201E-21	P(8) D	66	2909.589 43(26)	895.77	0.871E-22	R(13) X
32	2906.416 48(24)	142.38	0.140E-19	P(26) A	67	2909.751 83(17)	569.16	0.108E-20	R(15) B
33	2906.465 44(18)	528.95	0.566E-21	R(6) B	68	2909.765 42(17)	569.22	0.108E-20	R(15) C
34	2906.469 82(18)	528.96	0.566E-21	R(6) C	69	2909.796 88(25)	77.08	0.141E-19	P(19) A
35	2906.640 08(14)	870.29	0.179E-21	P(7) D	70	2909.816 18(14)	17.81	0.427E-21	R(9) P

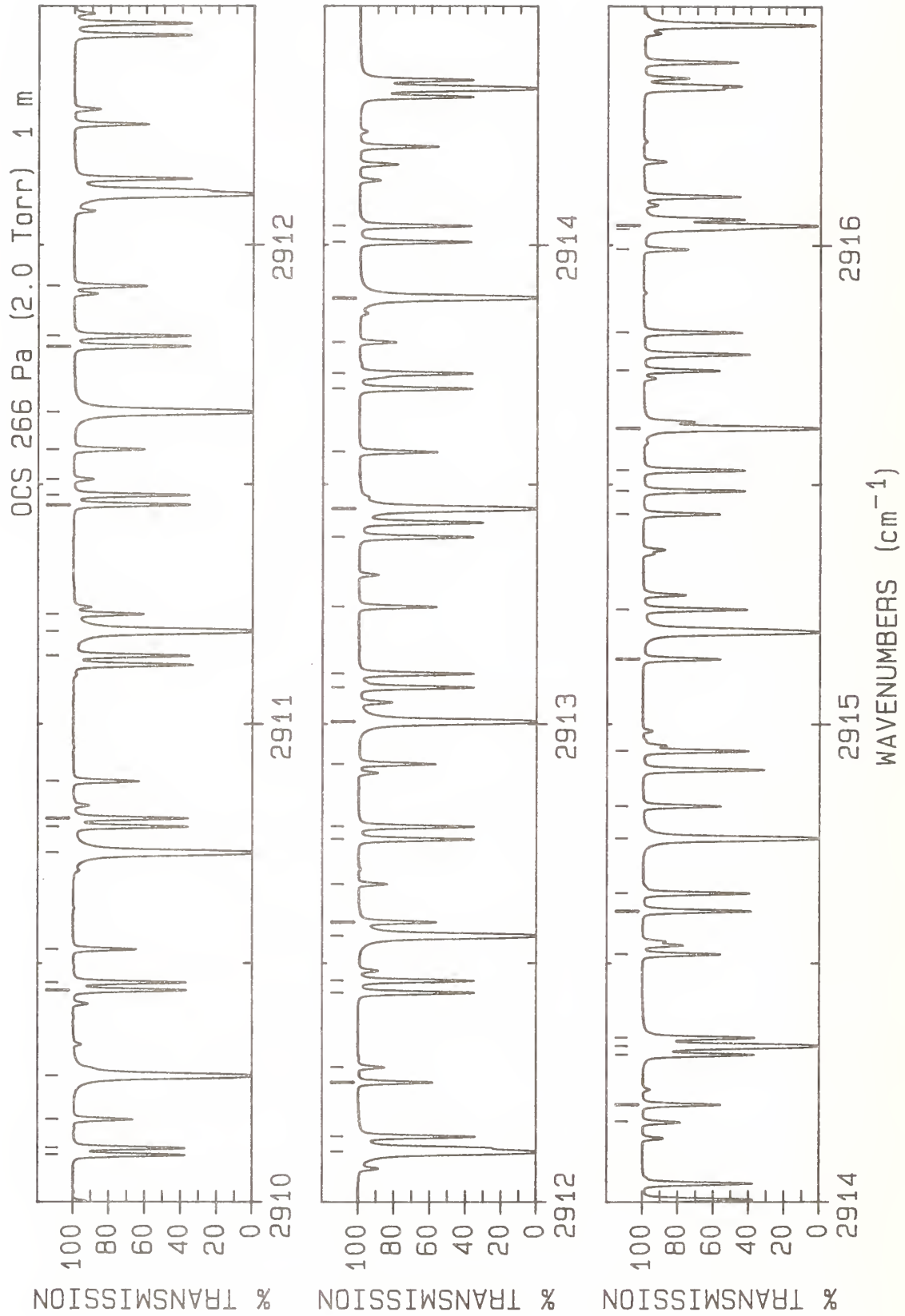

LINE #	WAVENUMBER(unc) (cm ⁻¹)	LOWER STATE (cm ⁻¹)	INTENSITY (cm/molecule)	ASSIGNMENT ROTATION BAND	LINE #	WAVENUMBER(unc) (cm ⁻¹)	LOWER STATE (cm ⁻¹)	INTENSITY (cm/molecule)	ASSIGNMENT ROTATION BAND
1	2910.099 82(17)	575.66	0.112E-20	R(16) B	36	2913.076 48(18)	652.42	0.118E-20	R(25) B
2	2910.114 67(17)	575.72	0.112E-20	R(16) C	37	2913.104 83(18)	652.56	0.118E-20	R(25) C
3	2910.174 45(14)	21.77	0.461E-21	R(10) P	38	2913.244 37(12)	75.19	0.647E-21	R(19) P
4	2910.265 71(25)	69.37	0.139E-19	P(18) A	39	2913.389 93(18)	662.98	0.116E-20	R(26) B
5	2910.444 36(17)	582.57	0.114E-20	R(17) B	40	2913.449 25(25)	26.78	0.104E-19	P(11) A
6	2910.460 52(17)	582.63	0.114E-20	R(17) C	41	2913.568 23(11)	83.11	0.654E-21	R(20) P
7	2910.529 30(14)	26.12	0.493E-21	R(11) P	42	2913.699 92(18)	673.94	0.114E-20	R(27) B
8	2910.731 04(25)	62.07	0.136E-19	P(17) A	43	2913.731 76(18)	674.10	0.114E-20	R(27) C
9	2910.785 46(17)	589.88	0.117E-20	R(18) B	44	2913.796 74(14)	881.21	0.260E-21	R(10) D
10	2910.802 98(17)	589.95	0.117E-20	R(18) C	45	2913.888 63(11)	91.42	0.658E-21	R(21) P
11	2910.880 72(13)	30.87	0.521E-21	R(12) P	46	2913.890 01(25)	22.31	0.970E-20	P(10) A
12	2911.142 04(17)	597.68	0.118E-20	R(19) C	47	2914.006 43(19)	685.31	0.112E-20	R(28) B
13	2911.192 84(25)	55.17	0.132E-19	P(16) A	48	2914.040 09(19)	685.49	0.112E-20	R(28) C
14	2911.228 71(13)	36.02	0.548E-21	R(13) P	49	2914.168 58(14)	885.66	0.275E-21	R(11) D
15	2911.457 31(17)	605.72	0.119E-20	R(20) B	50	2914.205 56(11)	100.13	0.660E-21	R(22) P
16	2911.477 70(17)	605.81	0.119E-20	R(20) C	51	2914.309 47(19)	697.09	0.110E-20	R(29) B
17	2911.510 81(15)	863.01	0.134E-21	R(4) D	52	2914.327 26(25)	18.26	0.890E-20	P(9) A
18	2911.573 27(13)	41.56	0.571E-21	R(14) P	53	2914.344 98(19)	697.27	0.109E-20	R(29) C
19	2911.651 14(25)	48.68	0.128E-19	P(15) A	54	2914.519 01(12)	109.23	0.659E-21	R(23) P
20	2911.788 06(17)	614.25	0.120E-20	R(21) B	55	2914.609 03(19)	709.27	0.107E-20	R(30) B
21	2911.809 95(17)	614.35	0.120E-20	R(21) C	56	2914.646 44(19)	709.47	0.107E-20	R(30) C
22	2911.914 38(12)	47.49	0.592E-21	R(15) P	57	2914.761 01(25)	14.61	0.806E-20	P(8) A
23	2912.105 93(25)	42.60	0.123E-19	P(14) A	58	2914.828 99(12)	118.72	0.655E-21	R(24) P
24	2912.138 79(17)	623.29	0.120E-20	R(22) C	59	2914.944 47(19)	722.07	0.104E-20	R(31) C
25	2912.252 05(12)	53.83	0.610E-21	R(16) P	60	2915.135 49(12)	128.62	0.650E-21	R(25) P
26	2912.283 51(14)	867.46	0.181E-21	R(6) D	61	2915.239 04(20)	735.07	0.100E-20	R(32) C
27	2912.439 19(18)	632.52	0.120E-20	R(23) B	62	2915.438 50(12)	138.90	0.642E-21	R(26) P
28	2912.464 22(18)	632.64	0.120E-20	R(23) C	63	2915.486 82(20)	748.25	0.969E-21	R(33) B
29	2912.557 21(25)	36.92	0.117E-19	P(13) A	64	2915.530 18(20)	748.49	0.968E-21	R(33) C
30	2912.586 28(12)	60.55	0.625E-21	R(17) P	65	2915.618 00(25)	8.52	0.622E-20	P(6) A
31	2912.665 78(13)	870.29	0.203E-21	R(7) D	66	2915.738 02(12)	149.59	0.632E-21	R(27) P
32	2912.759 57(18)	642.27	0.119E-20	R(24) B	67	2915.817 86(20)	762.31	0.932E-21	R(34) C
33	2912.786 24(18)	642.40	0.119E-20	R(24) C	68	2915.991 66(14)	913.98	0.321E-21	R(16) D
34	2912.917 05(12)	67.68	0.638E-21	R(18) P	69	2916.034 04(12)	160.67	0.620E-21	R(28) P
35	2913.004 98(25)	31.64	0.111E-19	P(12) A	70	2916.041 24(25)	6.09	0.525E-20	P(5) A

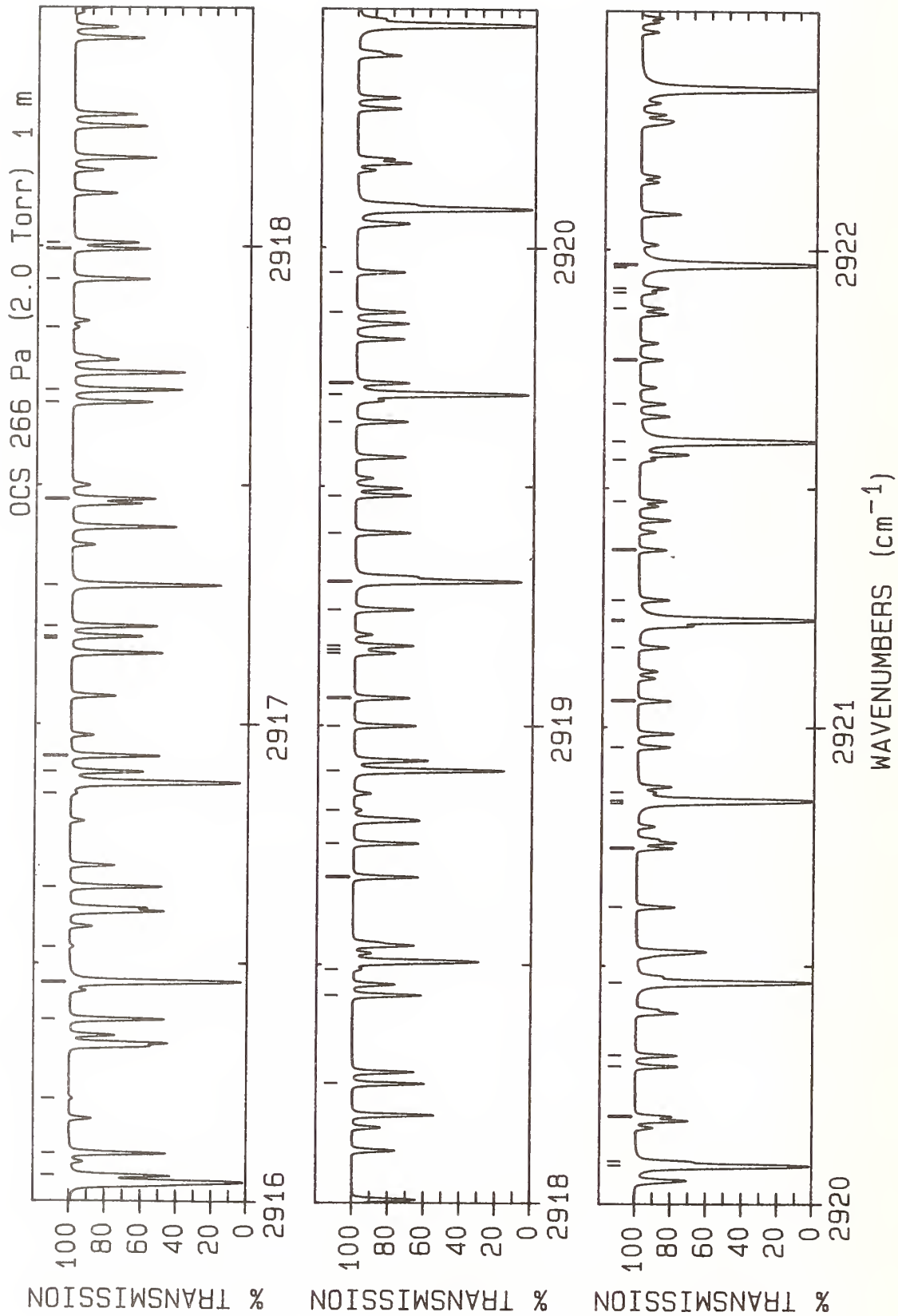

LINE #	WAVENUMBER(unc) (cm ⁻¹)	LOWER STATE (cm ⁻¹)	INTENSITY (cm/molecule)	ASSIGNMENT ROTATION BAND	LINE #	WAVENUMBER(unc) (cm ⁻¹)	LOWER STATE (cm ⁻¹)	INTENSITY (cm/molecule)	ASSIGNMENT ROTATION BAND
1	2916.054 57(20)	776.26	0.895E-21	R(35) B	36	2919.402 93(22)	997.88	0.416E-21	R(48) B
2	2916.102 09(20)	776.53	0.894E-21	R(35) C	37	2919.481 06(22)	998.38	0.415E-21	R(48) C
3	2916.216 67(17)*	670.17	0.251E-22	P(57) W	38	2919.635 81(22)	1017.76	0.385E-21	R(49) B
4	2916.382 87(21)	791.16	0.856E-21	R(36) C	39	2919.692 63(25)	2.43	0.428E-20	R(3) A
5	2916.460 98(25)	4.06	0.424E-20	P(4) A	40	2919.716 52(22)	1018.28	0.384E-21	R(49) C
6	2916.534 98(17)*	647.08	0.277E-22	P(56) W	41	2919.865 15(22)	1038.05	0.356E-21	R(50) B
7	2916.660 18(21)	806.20	0.817E-21	R(37) C	42	2919.948 47(22)	1038.59	0.355E-21	R(50) C
8	2916.855 49(17)*	624.39	0.305E-22	P(55) W	43	2920.080 79(25)	4.06	0.531E-20	R(4) A
9	2916.901 06(13)	196.27	0.576E-21	R(31) P	44	2920.090 95(22)	1058.74	0.328E-21	R(51) B
10	2916.934 03(21)	821.64	0.778E-21	R(38) C	45	2920.185 54(16)	1023.17	0.254E-21	R(28) D
11	2917.178 19(17)*	602.10	0.335E-22	P(54) W	46	2920.290 41(14)	391.68	0.313E-21	R(44) P
12	2917.183 04(13)	208.93	0.558E-21	R(32) P	47	2920.313 19(23)	1079.84	0.302E-21	R(52) B
13	2917.204 41(21)	837.49	0.739E-21	R(39) C	48	2920.465 44(25)	6.09	0.631E-20	R(5) A
14	2917.289 93(25)	1.22	0.215E-20	P(2) A	49	2920.623 19(23)	1101.95	0.276E-21	R(53) C
15	2917.471 32(21)	853.74	0.700E-21	R(40) C	50	2920.747 02(23)	1123.25	0.254E-21	R(54) B
16	2917.673 82(21)	870.04	0.663E-21	R(41) B	51	2920.841 03(23)	1123.88	0.253E-21	R(54) C
17	2917.699 15(25)	0.41	0.108E-20	P(1) A	52	2920.846 57(25)	8.52	0.727E-20	R(6) A
18	2917.830 03(16)*	558.74	0.401E-22	P(52) W	53	2920.864 49(16)*	383.65	0.794E-22	P(43) W
19	2917.931 41(22)	887.08	0.625E-21	R(42) B	54	2920.958 59(23)	1145.56	0.232E-21	R(55) B
20	2917.994 70(22)	887.47	0.623E-21	R(42) C	55	2921.055 35(23)	1146.22	0.231E-21	R(55) C
21	2918.007 81(14)	249.29	0.501E-21	R(35) P	56	2921.166 60(23)	1168.28	0.211E-21	R(56) B
22	2918.251 16(22)	904.94	0.586E-21	R(43) C	57	2921.222 18(16)	1059.56	0.214E-21	R(31) D
23	2918.436 03(22)	922.39	0.551E-21	R(44) B	58	2921.224 18(25)	11.36	0.820E-20	R(7) A
24	2918.490 30(16)*	517.00	0.475E-22	P(50) W	59	2921.266 12(23)	1168.96	0.211E-21	R(56) C
25	2918.683 05(22)	940.66	0.515E-21	R(45) B	60	2921.371 05(23)	1191.40	0.192E-21	R(57) B
26	2918.753 62(22)	941.10	0.514E-21	R(45) C	61	2921.473 34(23)	1192.10	0.192E-21	R(57) C
27	2918.823 52(16)*	496.74	0.515E-22	P(49) W	62	2921.559 98(16)*	349.19	0.898E-22	P(41) W
28	2918.905 77(25)	0.41	0.216E-20	R(1) A	63	2921.598 26(25)	14.61	0.908E-20	R(8) A
29	2918.999 60(22)	959.78	0.480E-21	R(46) C	64	2921.677 02(24)	1215.65	0.174E-21	R(58) C
30	2919.057 92(14)	308.62	0.417E-21	R(39) P	65	2921.769 23(24)	1238.86	0.158E-21	R(59) B
31	2919.151 18(15)	990.41	0.288E-21	R(25) D	66	2921.877 14(24)	1239.61	0.157E-21	R(59) C
32	2919.158 78(16)*	476.88	0.557E-22	P(48) W	67	2921.910 45(16)*	332.57	0.951E-22	P(40) W
33	2919.166 50(22)	978.40	0.448E-21	R(47) B	68	2921.919 39(17)	1085.84	0.186E-21	R(33) D
34	2919.242 08(22)	978.88	0.447E-21	R(47) C	69	2921.962 95(24)	1263.19	0.143E-21	R(60) B
35	2919.300 95(25)	1.22	0.323E-20	R(2) A	70	2921.968 82(25)	18.26	0.992E-20	R(9) A

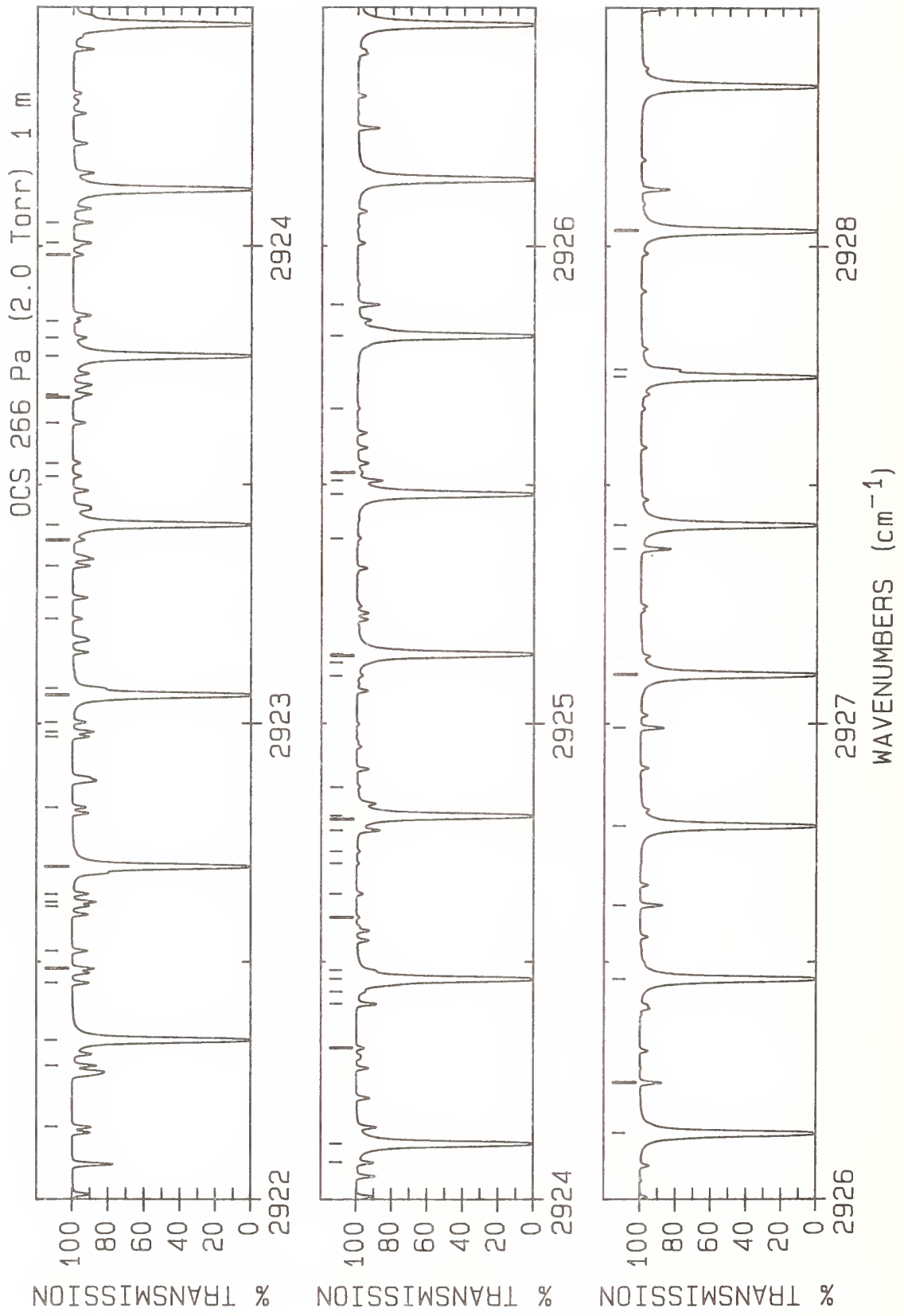

LINE #	WAVENUMBER(unc) (cm ⁻¹)	LOWER STATE (cm ⁻¹)	INTENSITY (cm/molecule)	ASSIGNMENT ROTATION BAND	LINE #	WAVENUMBER(unc) (cm ⁻¹)	LOWER STATE (cm ⁻¹)	INTENSITY (cm/molecule)	ASSIGNMENT ROTATION BAND
1	2922.153 10(24)	1287.93	0.129E-21	R(61) B	36	2924.411 93(17)*	227.55	0.132E-21	P(33) W
2	2922.282 67(15)	566.04	0.161E-21	R(53) P	37	2924.437 70(38)	1676.68	0.238E-22	R(75) B
3	2922.335 86(25)	22.31	0.107E-19	R(10) A	38	2924.463 82(25)	55.17	0.141E-19	R(16) A
4	2922.456 14(25)	1313.90	0.115E-21	R(62) C	39	2924.482 76(17)	848.22	0.501E-22	R(65) P
5	2922.485 97(15)	587.39	0.148E-21	R(54) P	40	2924.592 50(38)	1677.89	0.237E-22	R(75) C
6	2922.522 64(25)	1338.62	0.104E-21	R(63) B	41	2924.642 49(18)	874.29	0.448E-22	R(66) P
7	2922.616 68(16)*	300.54	0.106E-21	P(38) W	42	2924.706 32(47)	1738.67	0.181E-22	R(77) B
8	2922.625 41(17)	1113.73	0.158E-21	R(35) D	43	2924.731 60(42)	1708.71	0.207E-22	R(76) C
9	2922.642 01(25)	1339.47	0.103E-21	R(63) C	44	2924.775 85(17)*	214.17	0.137E-21	P(32) W
10	2922.699 36(25)	26.78	0.114E-19	R(11) A	45	2924.798 59(19)	900.76	0.400E-22	R(67) P
11	2922.824 30(25)	1365.45	0.925E-22	R(64) C	46	2924.806 07(25)	62.07	0.144E-19	R(17) A
12	2922.972 40(17)*	285.13	0.111E-21	P(37) W	47	2924.867 08(47)	1739.94	0.180E-22	R(77) C
13	2922.982 84(16)	1128.29	0.144E-21	R(36) D	48	2925.099 90(23)	954.88	0.316E-22	R(69) P
14	2923.003 02(25)	1391.83	0.826E-22	R(65) C	49	2925.127 16(58)	1803.61	0.135E-22	R(79) C
15	2923.059 33(25)	31.64	0.121E-19	R(12) A	50	2925.141 34(17)*	201.19	0.141E-21	P(31) W
16	2923.074 13(16)	653.80	0.113E-21	R(57) P	51	2925.144 77(25)	69.37	0.147E-19	R(18) A
17	2923.218 64(26)	1444.85	0.658E-22	R(67) B	52	2925.386 73(30)	1010.57	0.248E-22	R(71) P
18	2923.262 93(16)	676.72	0.103E-21	R(58) P	53	2925.479 92(25)	77.08	0.149E-19	R(19) A
19	2923.329 80(17)*	270.13	0.117E-21	P(36) W	54	2925.508 38(17)*	188.62	0.145E-21	P(30) W
20	2923.383 65(26)	1472.41	0.584E-22	R(68) B	55	2925.524 72(35)	1039.01	0.219E-22	R(72) P
21	2923.415 77(25)	36.92	0.127E-19	R(13) A	56	2925.659 10(42)	1067.84	0.193E-22	R(73) P
22	2923.517 65(26)	1473.41	0.581E-22	R(68) C	57	2925.811 49(25)	85.19	0.151E-19	R(20) A
23	2923.545 05(27)	1500.39	0.517E-22	R(69) B	58	2925.876 93(17)*	176.45	0.149E-21	P(29) W
24	2923.629 62(17)	723.75	0.847E-22	R(60) P	59	2926.139 51(25)	93.71	0.151E-19	R(21) A
25	2923.682 01(27)	1501.41	0.515E-22	R(69) C	60	2926.246 99(17)*	164.69	0.152E-21	P(28) W
26	2923.688 88(17)*	255.53	0.122E-21	P(35) W	61	2926.463 95(25)	102.63	0.152E-19	R(22) A
27	2923.768 66(25)	42.60	0.132E-19	R(14) A	62	2926.618 51(17)*	153.34	0.155E-21	P(27) W
28	2923.807 52(17)	747.86	0.766E-22	R(61) P	63	2926.784 82(25)	111.96	0.151E-19	R(23) A
29	2923.842 77(28)	1529.81	0.455E-22	R(70) C	64	2926.991 49(17)*	142.38	0.158E-21	P(26) W
30	2923.981 78(17)	772.36	0.691E-22	R(62) P	65	2927.102 10(24)	121.70	0.150E-19	R(24) A
31	2924.007 63(30)	1586.72	0.354E-22	R(72) B	66	2927.365 91(17)*	131.84	0.160E-21	P(25) W
32	2924.049 60(17)*	241.34	0.127E-21	P(34) W	67	2927.415 81(24)	131.84	0.149E-19	R(25) A
33	2924.078 28(16)	1174.37	0.106E-21	R(39) D	68	2927.725 92(24)	142.38	0.147E-19	R(26) A
34	2924.118 02(25)	48.68	0.137E-19	R(15) A	69	2927.741 73(17)*	121.70	0.161E-21	P(24) W
35	2924.319 40(17)	822.54	0.558E-22	R(64) P	70	2928.032 44(24)	153.34	0.144E-19	R(27) A

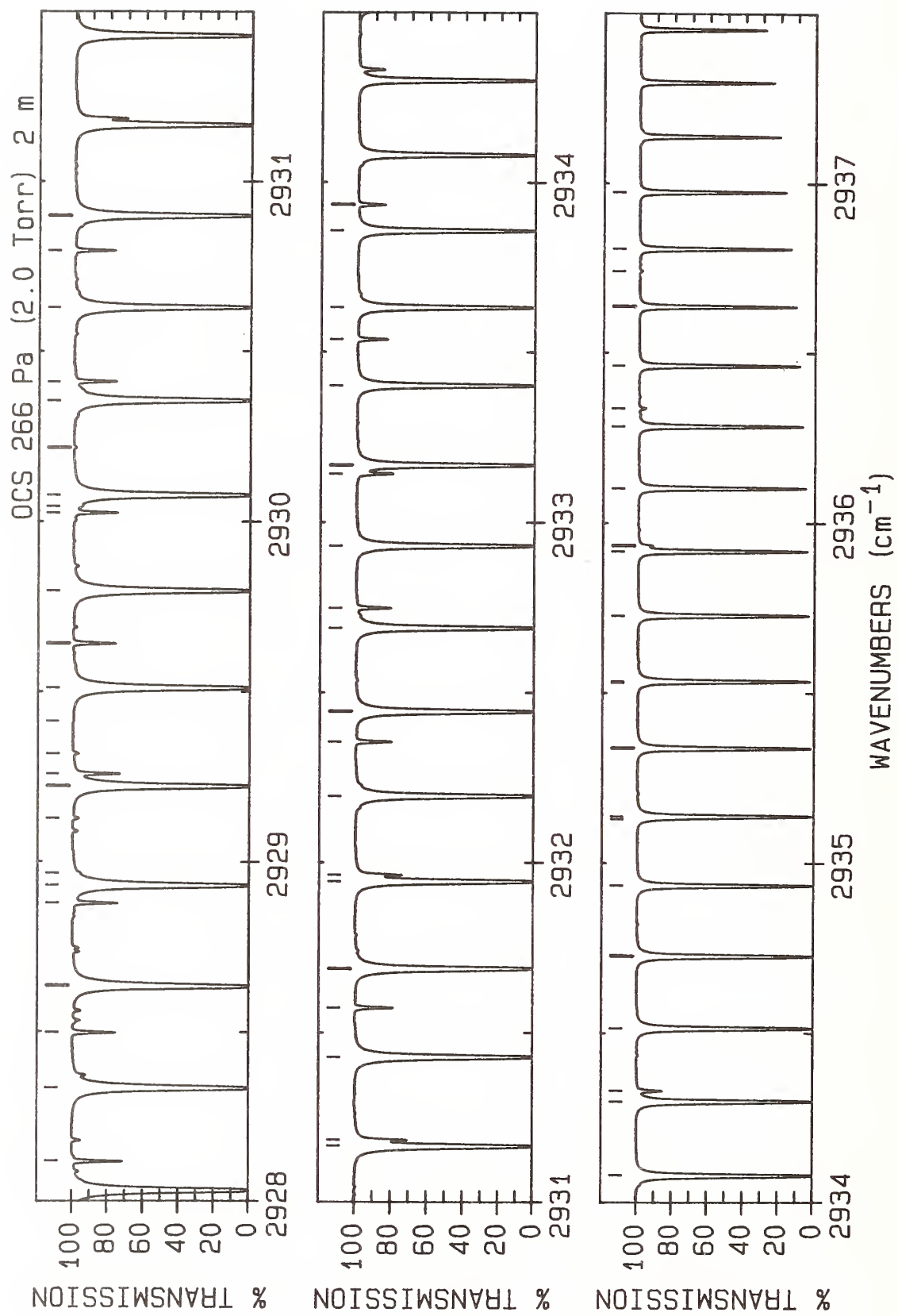

LINE #	WAVENUMBER(unc) (cm ⁻¹)	LOWER STATE (cm ⁻¹)	INTENSITY (cm/molecule)	ASSIGNMENT ROTATION BAND	LINE #	WAVENUMBER(unc) (cm ⁻¹)	LOWER STATE (cm ⁻¹)	INTENSITY (cm/molecule)	ASSIGNMENT ROTATION BAND
1	2928.118 4	551.71	0.307E-22	R(52) L	36	2932.689 03(24)	401.49	0.695E-20	R(44) A
2	2928.118 95(17)*	111.96	0.162E-21	P(23) W	37	2932.748 37(19)*	26.78	0.118E-21	P(11) W
3	2928.335 37(24)	164.69	0.141E-19	R(28) A	38	2932.930 08(24)	419.73	0.651E-20	R(45) A
4	2928.497 55(17)*	102.63	0.163E-21	P(22) W	39	2933.142 31(19)*	22.31	0.109E-21	P(10) W
5	2928.634 69(24)	176.45	0.138E-19	R(29) A	40	2933.167 45(24)	438.37	0.607E-20	R(46) A
6	2928.877 51(17)*	93.71	0.162E-21	P(21) W	41	2933.401 14(24)	457.42	0.565E-20	R(47) A
7	2928.930 40(24)	188.62	0.135E-19	R(30) A	42	2933.537 45(19)*	18.26	0.100E-21	P(9) W
8	2928.966 31(42)	1395.03	0.669E-23	R(51) D	43	2933.631 14(25)	476.88	0.525E-20	R(48) A
9	2929.127 2	661.74	0.197E-22	R(57) L	44	2933.857 45(25)	496.74	0.486E-20	R(49) A
10	2929.222 50(24)	201.19	0.131E-19	R(31) A	45	2933.933 79(20)*	14.61	0.909E-22	P(8) W
11	2929.258 80(17)*	85.19	0.161E-21	P(20) W	46	2934.080 06(25)	517.00	0.450E-20	R(50) A
12	2929.317 9	684.94	0.179E-22	R(58) L	47	2934.298 98(25)	537.67	0.415E-20	R(51) A
13	2929.414 01(44)	1416.04	0.263E-23	R(52) D	48	2934.331 31(20)*	11.36	0.808E-22	P(7) W
14	2929.510 99(24)	214.17	0.127E-19	R(32) A	49	2934.514 19(25)	558.74	0.381E-20	R(52) A
15	2929.641 42(17)*	77.08	0.159E-21	P(19) W	50	2934.725 70(25)	580.22	0.350E-20	R(53) A
16	2929.795 85(24)	227.55	0.122E-19	R(33) A	51	2934.730 02(20)*	8.52	0.702E-22	P(6) W
17	2930.025 35(17)*	69.37	0.156E-21	P(18) W	52	2934.933 50(25)	602.10	0.321E-20	R(54) A
18	2930.044 1	781.74	0.119E-22	R(62) L	53	2935.129 90(20)*	6.09	0.592E-22	P(5) W
19	2930.077 09(24)	241.34	0.118E-19	R(34) A	54	2935.137 59(25)	624.39	0.293E-20	R(55) A
20	2930.216 5	806.93	0.107E-22	R(63) L	55	2935.337 96(26)	647.08	0.267E-20	R(56) A
21	2930.354 70(24)	255.53	0.113E-19	R(35) A	56	2935.530 96(20)*	4.06	0.479E-22	P(4) W
22	2930.410 58(17)*	62.07	0.153E-21	P(17) W	57	2935.534 61(26)	670.17	0.243E-20	R(57) A
23	2930.628 67(24)	270.13	0.108E-19	R(36) A	58	2935.727 55(26)	693.67	0.221E-20	R(58) A
24	2930.797 08(18)*	55.17	0.149E-21	P(16) W	59	2935.916 76(26)	717.57	0.200E-20	R(59) A
25	2930.899 01(24)	285.13	0.103E-19	R(37) A	60	2935.933 19(21)*	2.43	0.362E-22	P(3) W
26	2931.165 70(24)	300.54	0.984E-20	R(38) A	61	2936.102 24(26)	741.87	0.180E-20	R(60) A
27	2931.184 85(18)*	48.68	0.144E-21	P(15) W	62	2936.284 00(26)	766.58	0.163E-20	R(61) A
28	2931.428 73(24)	316.35	0.934E-20	R(39) A	63	2936.336 58(21)*	1.22	0.243E-22	P(2) W
29	2931.573 88(18)*	42.60	0.139E-21	P(14) W	64	2936.462 03(26)	791.70	0.146E-20	R(62) A
30	2931.688 12(24)	332.57	0.885E-20	R(40) A	65	2936.636 32(27)	817.21	0.131E-20	R(63) A
31	2931.943 85(24)	349.19	0.837E-20	R(41) A	66	2936.741 13(21)*	0.41	0.122E-22	P(1) W
32	2931.964 15(18)*	36.92	0.132E-21	P(13) W	67	2936.806 88(27)	843.13	0.118E-20	R(64) A
33	2932.195 91(24)	366.22	0.789E-20	R(42) A	68	2936.973 70(27)	869.46	0.105E-20	R(65) A
34	2932.355 65(19)*	31.64	0.125E-21	P(12) W					
35	2932.444 31(24)	383.65	0.741E-20	R(43) A					

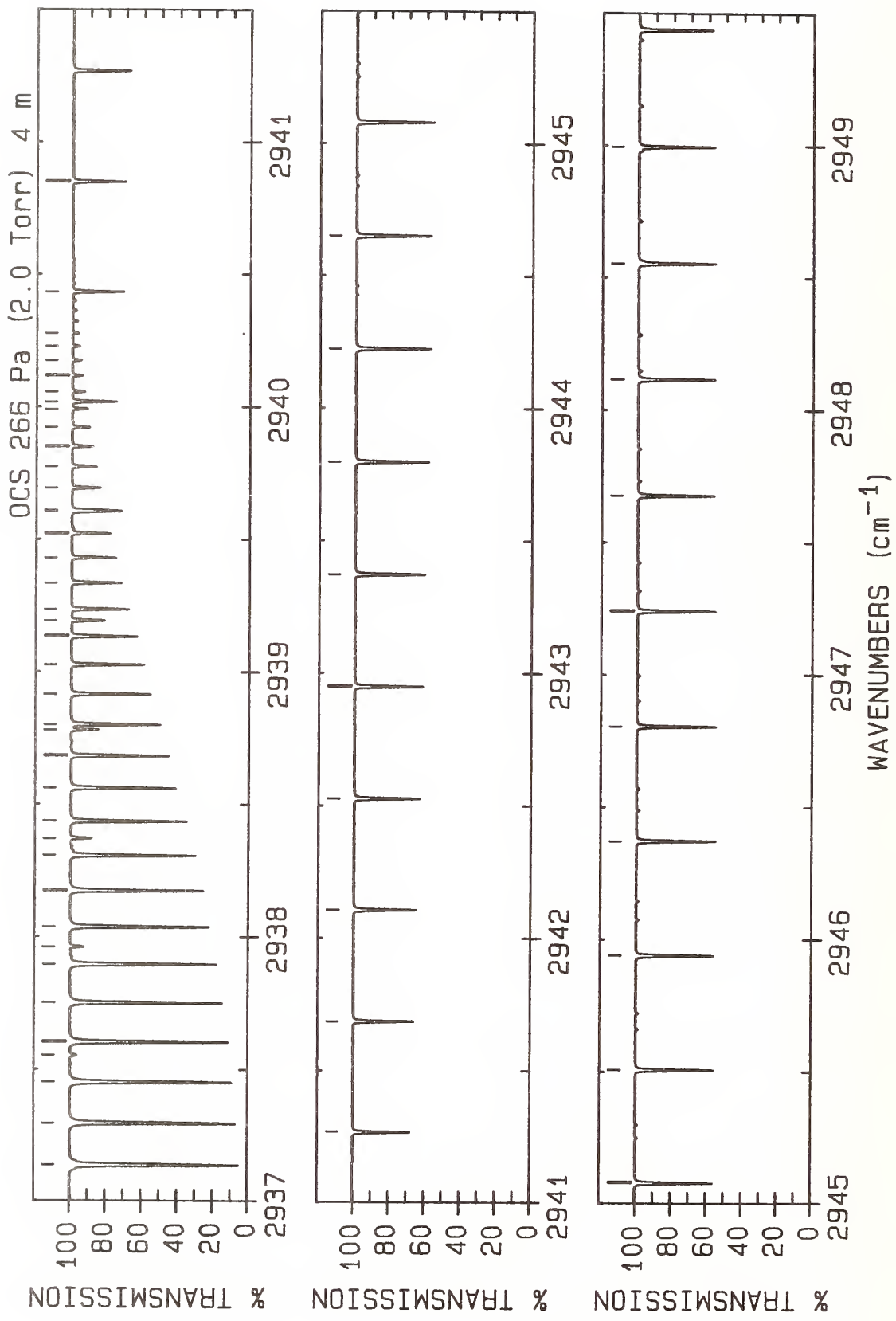

LINE #	WAVENUMBER(unc) (cm ⁻¹)	LOWER STATE (cm ⁻¹)	INTENSITY (cm/molecule)	ASSIGNMENT ROTATION BAND	LINE #	WAVENUMBER(unc) (cm ⁻¹)	LOWER STATE (cm ⁻¹)	INTENSITY (cm/molecule)	ASSIGNMENT ROTATION BAND	LINE #	WAVENUMBER(unc) (cm ⁻¹)	LOWER STATE (cm ⁻¹)	INTENSITY (cm/molecule)	ASSIGNMENT ROTATION BAND
1	2937.136 79(27)	896.18	0.936E-21	R(66) A	31	2939.922 67(37)	1658.48	0.313E-22	R(90) A	31	2939.922 67(37)	1658.48	0.313E-22	R(90) A
2	2937.296 13(27)	923.31	0.833E-21	R(67) A	32	2939.991 34(38)	1695.27	0.265E-22	R(91) A	32	2939.991 34(38)	1695.27	0.265E-22	R(91) A
3	2937.451 73(27)	950.85	0.739E-21	R(68) A	33	2940.019 34(20)*	8.52	0.821E-22	R(6) W	33	2940.019 34(20)*	8.52	0.821E-22	R(6) W
4	2937.553 72(21)*	0.00	0.122E-22	R(0) W	34	2940.056 16(39)	1732.46	0.223E-22	R(92) A	34	2940.056 16(39)	1732.46	0.223E-22	R(92) A
5	2937.603 58(28)	978.78	0.655E-21	R(69) A	35	2940.117 11(42)	1770.05	0.188E-22	R(93) A	35	2940.117 11(42)	1770.05	0.188E-22	R(93) A
6	2937.751 68(28)	1007.13	0.579E-21	R(70) A	36	2940.174 20(45)	1808.05	0.158E-22	R(94) A	36	2940.174 20(45)	1808.05	0.158E-22	R(94) A
7	2937.896 04(28)	1035.87	0.510E-21	R(71) A	37	2940.227 40(50)	1846.44	0.133E-22	R(95) A	37	2940.227 40(50)	1846.44	0.133E-22	R(95) A
8	2937.961 75(21)*	0.41	0.244E-22	R(1) W	38	2940.276 70(56)	1885.23	0.111E-22	R(96) A	38	2940.276 70(56)	1885.23	0.111E-22	R(96) A
9	2938.036 64(29)	1065.02	0.449E-21	R(72) A	39	2940.434 36(19)*	11.36	0.925E-22	R(7) W	39	2940.434 36(19)*	11.36	0.925E-22	R(7) W
10	2938.173 49(29)	1094.57	0.394E-21	R(73) A	40	2940.850 56(19)*	14.61	0.102E-21	R(8) W	40	2940.850 56(19)*	14.61	0.102E-21	R(8) W
11	2938.306 59(30)	1124.52	0.346E-21	R(74) A	41	2941.267 95(19)*	18.26	0.112E-21	R(9) W	41	2941.267 95(19)*	18.26	0.112E-21	R(9) W
12	2938.370 94(20)*	1.22	0.364E-22	R(2) W	42	2941.686 53(19)*	22.31	0.121E-21	R(10) W	42	2941.686 53(19)*	22.31	0.121E-21	R(10) W
13	2938.435 92(30)	1154.87	0.302E-21	R(75) A	43	2942.106 30(18)*	26.78	0.129E-21	R(11) W	43	2942.106 30(18)*	26.78	0.129E-21	R(11) W
14	2938.561 50(30)	1185.63	0.264E-21	R(76) A	44	2942.527 28(18)*	31.64	0.136E-21	R(12) W	44	2942.527 28(18)*	31.64	0.136E-21	R(12) W
15	2938.683 31(31)	1216.79	0.229E-21	R(77) A	45	2942.949 48(18)*	36.92	0.143E-21	R(13) W	45	2942.949 48(18)*	36.92	0.143E-21	R(13) W
16	2938.781 29(20)*	2.43	0.483E-22	R(3) W	46	2943.372 90(18)*	42.60	0.149E-21	R(14) W	46	2943.372 90(18)*	42.60	0.149E-21	R(14) W
17	2938.801 36(31)	1248.35	0.199E-21	R(78) A	47	2943.797 56(17)*	48.68	0.154E-21	R(15) W	47	2943.797 56(17)*	48.68	0.154E-21	R(15) W
18	2938.915 63(32)	1280.32	0.173E-21	R(79) A	48	2944.223 46(17)*	55.17	0.159E-21	R(16) W	48	2944.223 46(17)*	55.17	0.159E-21	R(16) W
19	2939.026 14(33)	1312.69	0.150E-21	R(80) A	49	2944.650 62(17)*	62.07	0.163E-21	R(17) W	49	2944.650 62(17)*	62.07	0.163E-21	R(17) W
20	2939.132 86(33)	1345.46	0.129E-21	R(81) A	50	2945.079 05(17)*	69.37	0.166E-21	R(18) W	50	2945.079 05(17)*	69.37	0.166E-21	R(18) W
21	2939.192 81(20)*	4.06	0.599E-22	R(4) W	51	2945.508 76(17)*	77.08	0.168E-21	R(19) W	51	2945.508 76(17)*	77.08	0.168E-21	R(19) W
22	2939.235 81(34)	1378.63	0.111E-21	R(82) A	52	2945.939 77(17)*	85.19	0.170E-21	R(20) W	52	2945.939 77(17)*	85.19	0.170E-21	R(20) W
23	2939.334 97(34)	1412.21	0.956E-22	R(83) A	53	2946.372 10(17)*	93.71	0.171E-21	R(21) W	53	2946.372 10(17)*	93.71	0.171E-21	R(21) W
24	2939.430 35(34)	1446.18	0.820E-22	R(84) A	54	2946.805 75(17)*	102.63	0.171E-21	R(22) W	54	2946.805 75(17)*	102.63	0.171E-21	R(22) W
25	2939.521 92(35)	1480.56	0.702E-22	R(85) A	55	2947.240 75(17)*	111.96	0.170E-21	R(23) W	55	2947.240 75(17)*	111.96	0.170E-21	R(23) W
26	2939.605 49(20)*	6.09	0.712E-22	R(5) W	56	2947.677 11(17)*	121.70	0.169E-21	R(24) W	56	2947.677 11(17)*	121.70	0.169E-21	R(24) W
27	2939.609 70(35)	1515.34	0.600E-22	R(86) A	57	2948.114 86(17)*	131.84	0.167E-21	R(25) W	57	2948.114 86(17)*	131.84	0.167E-21	R(25) W
28	2939.693 67(35)	1550.53	0.511E-22	R(87) A	58	2948.554 00(17)*	142.38	0.165E-21	R(26) W	58	2948.554 00(17)*	142.38	0.165E-21	R(26) W
29	2939.773 83(36)	1586.11	0.435E-22	R(88) A	59	2948.994 56(17)*	153.34	0.162E-21	R(27) W	59	2948.994 56(17)*	153.34	0.162E-21	R(27) W
30	2939.850 17(36)	1622.10	0.369E-22	R(89) A										

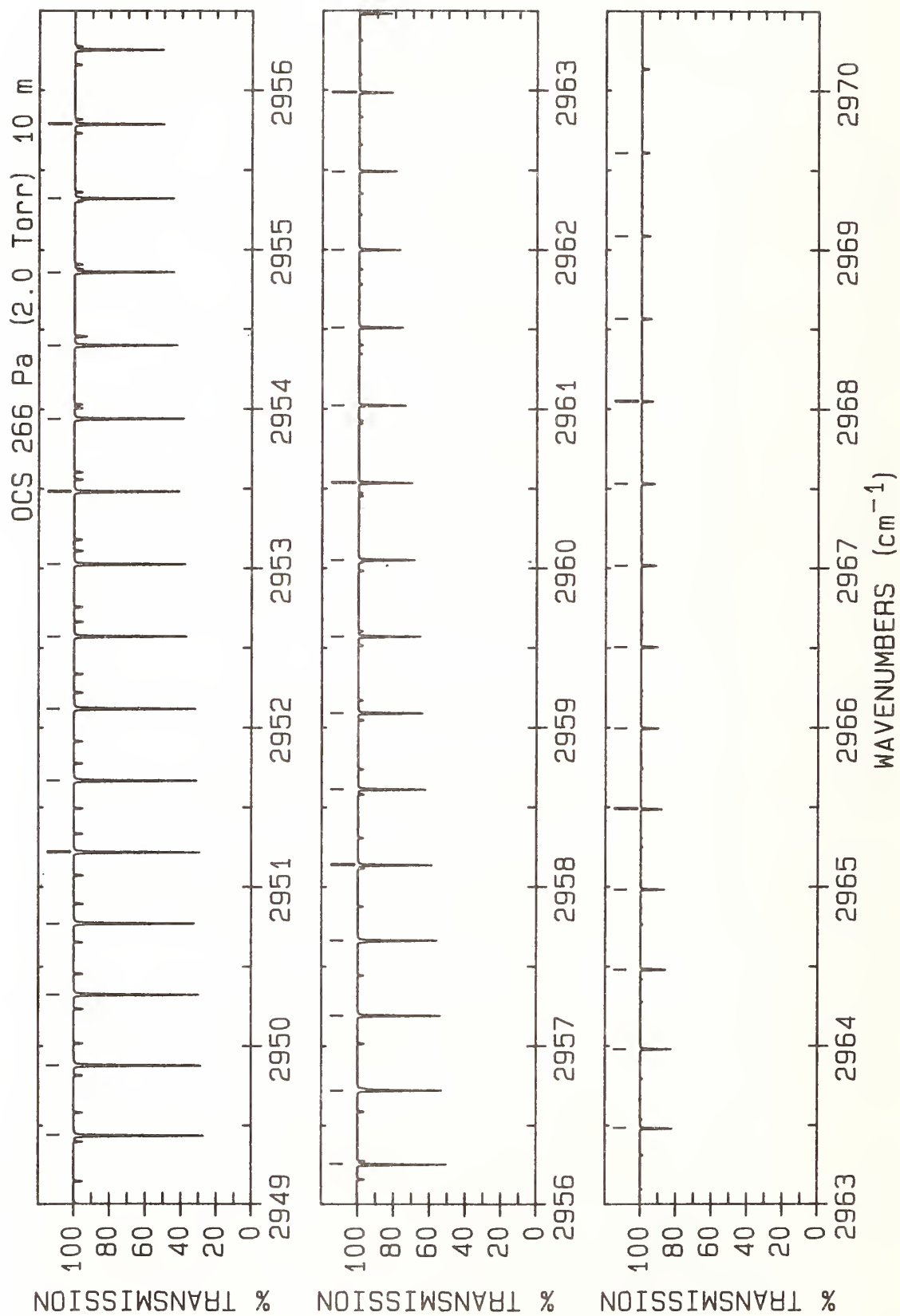

LINE #	WAVENUMBER(unc) (cm ⁻¹)	LOWER STATE (cm ⁻¹)	INTENSITY (cm/molecule)	ASSIGNMENT ROTATION BAND	LINE #	WAVENUMBER(unc) (cm ⁻¹)	LOWER STATE (cm ⁻¹)	INTENSITY (cm/molecule)	ASSIGNMENT ROTATION BAND
1	2949.436 55(17)*	164.69	0.159E-21	R(28) W	26	2961.022 02(17)*	580.22	0.377E-22	R(53) W
2	2949.880 01(17)*	176.45	0.155E-21	R(29) W	27	2961.509 78(17)*	602.10	0.344E-22	R(54) W
3	2950.324 94(17)*	188.62	0.151E-21	R(30) W	28	2961.999 63(17)*	624.39	0.313E-22	R(55) W
4	2950.771 37(17)*	201.19	0.147E-21	R(31) W	29	2962.491 59(17)*	647.08	0.284E-22	R(56) W
5	2951.219 33(17)*	214.17	0.142E-21	R(32) W	30	2962.985 68(17)*	670.17	0.257E-22	R(57) W
6	2951.668 84(17)*	227.55	0.137E-21	R(33) W	31	2963.481 92(17)*	693.67	0.233E-22	R(58) W
7	2952.119 91(17)*	241.34	0.132E-21	R(34) W	32	2963.980 32(17)*	717.57	0.210E-22	R(59) W
8	2952.572 58(17)*	255.53	0.126E-21	R(35) W	33	2964.480 91(18)*	741.87	0.189E-22	R(60) W
9	2953.026 87(16)*	270.13	0.121E-21	R(36) W	34	2964.983 70(18)*	766.58	0.169E-22	R(61) W
10	2953.482 80(16)*	285.13	0.115E-21	R(37) W	35	2965.488 71(18)*	791.70	0.152E-22	R(62) W
11	2953.940 40(16)*	300.54	0.110E-21	R(38) W	36	2965.995 94(18)*	817.21	0.135E-22	R(63) W
12	2954.399 69(16)*	316.35	0.104E-21	R(39) W	37	2966.505 41(19)*	843.13	0.121E-22	R(64) W
13	2954.860 70(16)*	332.57	0.983E-22	R(40) W	38	2967.017 13(19)*	869.46	0.107E-22	R(65) W
14	2955.323 46(16)*	349.19	0.927E-22	R(41) W	39	2967.531 11(19)*	896.18	0.950E-23	R(66) W
15	2955.787 98(16)*	366.22	0.873E-22	R(42) W	40	2968.047 36(20)*	923.31	0.841E-23	R(67) W
16	2956.254 31(16)*	383.65	0.819E-22	R(43) W	41	2968.565 89(20)*	950.85	0.742E-23	R(68) W
17	2956.722 45(16)*	401.49	0.766E-22	R(44) W	42	2969.086 71(21)*	978.78	0.654E-23	R(69) W
18	2957.192 45(16)*	419.73	0.716E-22	R(45) W	43	2969.609 81(21)*	1007.13	0.574E-23	R(70) W
19	2957.664 32(16)*	438.37	0.666E-22	R(46) W					
20	2958.138 09(16)*	457.42	0.619E-22	R(47) W					
21	2958.613 79(16)*	476.88	0.573E-22	R(48) W					
22	2959.091 44(16)*	496.74	0.530E-22	R(49) W					
23	2959.571 06(16)*	517.00	0.488E-22	R(50) W					
24	2960.052 68(16)*	537.67	0.449E-22	R(51) W					
25	2960.536 33(17)*	558.74	0.412E-22	R(52) W					

ATLAS OF OCS ABSORPTION LINES FROM 3065 cm^{-1} to 3120 cm^{-1}

key:

Band	Isotopomer	Vibrational Transition
A	$^{16}\text{O}^{12}\text{C}^{32}\text{S}$	12^00-00^00
B		$13^10-01^{1e}0$
C		$13^10-01^{1f}0$
D		12^01-00^01
P	$^{16}\text{O}^{12}\text{C}^{34}\text{S}$	12^00-00^00

If the e or f designation is not specified (for $l \neq 0$), then the transition is to either level, depending on the selection rules and the change in the rotational quantum number, J . Spectra are given for a slitwidth of 0.003 cm^{-1} , a temperature of 296 K, and a transition moment of 0.008 debye. No Herman-Wallis constant was included in the intensity calculation. Since no heterodyne measurements are available for this region, all uncertainties have been increased by 0.0002 cm^{-1} .

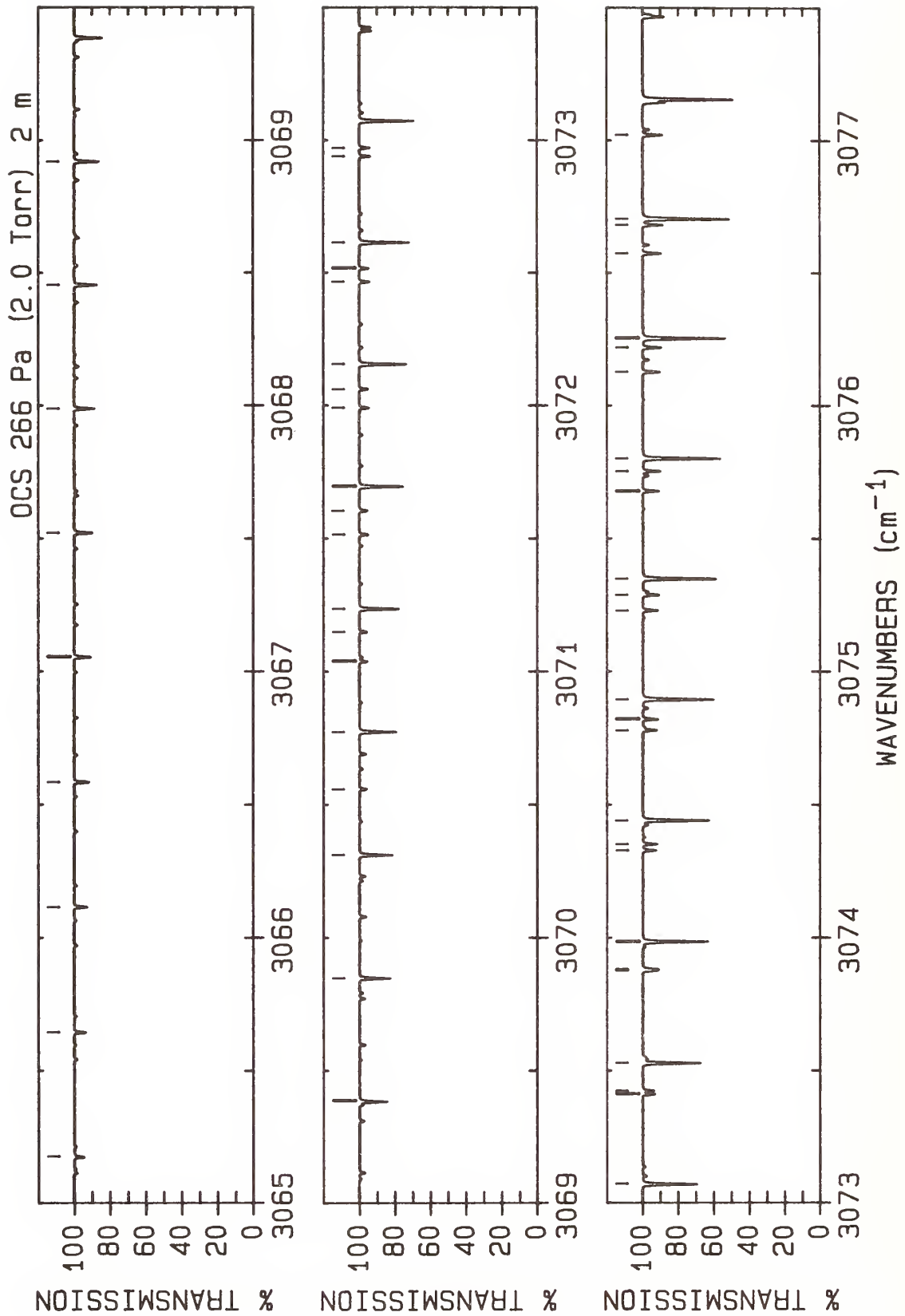

LINE #	WAVENUMBER(unc) (cm ⁻¹)	LOWER STATE (cm ⁻¹)	INTENSITY (cm/molecule)	ASSIGNMENT ROTATION BAND	LINE #	WAVENUMBER(unc) (cm ⁻¹)	LOWER STATE (cm ⁻¹)	INTENSITY (cm/molecule)	ASSIGNMENT ROTATION BAND
1	3065.175 02(57)	978.78	0.364E-22	P(69) A	31	3073.424 71(55)	1038.59	0.405E-22	P(50) C
2	3065.645 80(52)	950.85	0.412E-22	P(68) A	32	3073.529 59(30)	537.67	0.234E-21	P(51) A
3	3066.115 85(48)	923.31	0.465E-22	P(67) A	33	3073.877 33(49)	1018.28	0.438E-22	P(49) C
4	3066.585 15(44)	896.18	0.523E-22	P(66) A	34	3073.882 87(42)	997.88	0.474E-22	P(48) B
5	3067.053 70(41)	869.46	0.587E-22	P(65) A	35	3073.985 86(30)	517.00	0.254E-21	P(50) A
6	3067.521 48(38)	843.13	0.658E-22	P(64) A	36	3074.329 06(44)	998.38	0.473E-22	P(48) C
7	3067.988 49(36)	817.21	0.736E-22	P(63) A	37	3074.352 58(39)	978.40	0.510E-22	P(47) B
8	3068.454 73(34)	791.70	0.820E-22	P(62) A	38	3074.441 24(29)	496.74	0.275E-21	P(49) A
9	3068.920 18(33)	766.58	0.913E-22	P(61) A	39	3074.779 90(40)	978.88	0.509E-22	P(47) C
10	3069.384 83(32)	741.87	0.101E-21	P(60) A	40	3074.821 01(37)	959.33	0.548E-22	P(46) B
11	3069.848 68(32)	717.57	0.112E-21	P(59) A	41	3074.895 73(29)	476.88	0.297E-21	P(48) A
12	3070.311 72(31)	693.67	0.124E-21	P(58) A	42	3075.229 84(38)	959.78	0.547E-22	P(46) C
13	3070.559 1	1145.56	0.264E-22	P(55) B	43	3075.288 14(36)	940.66	0.587E-22	P(45) B
14	3070.773 93(31)	670.17	0.137E-21	P(57) A	44	3075.349 33(29)	457.42	0.320E-21	P(47) A
15	3071.037 76(97)	1123.25	0.289E-22	P(54) B	45	3075.678 89(36)	941.10	0.586E-22	P(45) C
16	3071.148 4	1146.22	0.264E-22	P(55) C	46	3075.753 97(36)	922.39	0.628E-22	P(44) B
17	3071.235 33(31)	647.08	0.151E-21	P(56) A	47	3075.802 02(29)	438.37	0.343E-21	P(46) A
18	3071.515 11(82)	1101.34	0.316E-22	P(53) B	48	3076.127 04(35)	922.82	0.627E-22	P(44) C
19	3071.605 4	1123.88	0.289E-22	P(54) C	49	3076.218 50(35)	904.54	0.669E-22	P(43) B
20	3071.695 88(31)	624.39	0.165E-21	P(55) A	50	3076.253 81(28)	419.73	0.368E-21	P(45) A
21	3071.991 21(70)	1079.84	0.344E-22	P(52) B	51	3076.574 28(34)	904.94	0.668E-22	P(43) C
22	3072.061 55(87)	1101.95	0.315E-22	P(53) C	52	3076.681 73(35)	887.08	0.712E-22	P(42) B
23	3072.155 59(31)	602.10	0.181E-21	P(54) A	53	3076.704 68(28)	401.49	0.393E-21	P(44) A
24	3072.466 03(60)	1058.74	0.375E-22	P(51) B	54	3077.020 62(34)	887.47	0.711E-22	P(42) C
25	3072.516 82(74)	1080.42	0.344E-22	P(52) C					
26	3072.614 45(30)	580.22	0.198E-21	P(53) A					
27	3072.939 59(53)	1038.05	0.406E-22	P(50) B					
28	3072.971 20(64)	1059.31	0.374E-22	P(51) C					
29	3073.072 46(30)	558.74	0.215E-21	P(52) A					
30	3073.411 87(47)	1017.76	0.439E-22	P(49) B					

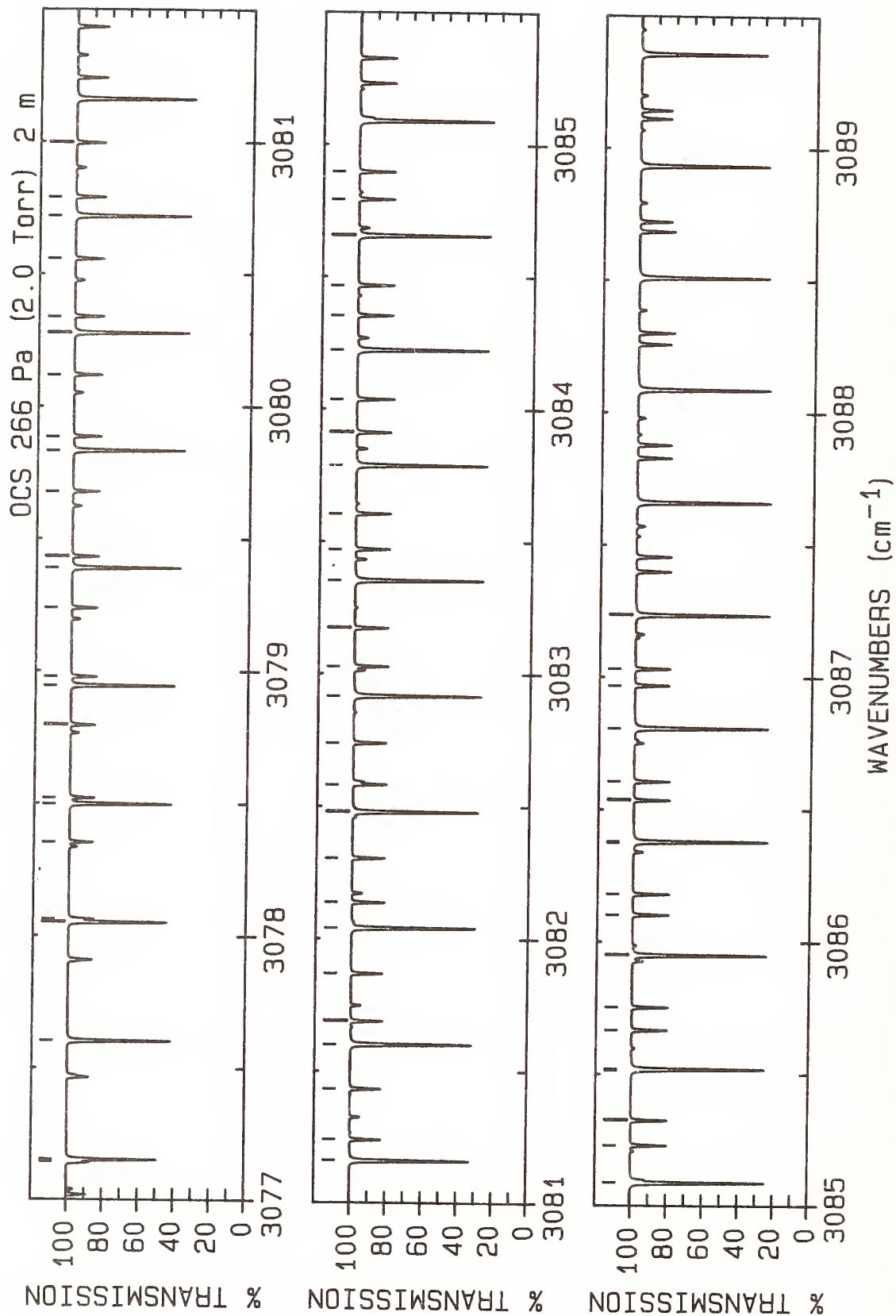

LINE #	WAVENUMBER(unc) (cm ⁻¹)	LOWER STATE (cm ⁻¹)	INTENSITY (cm/molecule)	ASSIGNMENT ROTATION BAND	LINE #	WAVENUMBER(unc) (cm ⁻¹)	LOWER STATE (cm ⁻¹)	INTENSITY (cm/molecule)	ASSIGNMENT ROTATION BAND
1	3077.143 64(34)	870.04	0.755E-22	P(41) B	36	3082.583 39(32)	697.09	0.124E-21	P(29) B
2	3077.154 62(28)	383.65	0.419E-21	P(43) A	37	3082.739 66(31)	697.27	0.124E-21	P(29) C
3	3077.603 64(28)	366.22	0.446E-21	P(42) A	38	3082.917 07(27)	188.62	0.759E-21	P(30) A
4	3077.604 25(34)	853.39	0.799E-22	P(40) B	39	3083.028 01(31)	685.31	0.127E-21	P(28) B
5	3078.051 72(28)	349.19	0.473E-21	P(41) A	40	3083.173 10(31)	685.49	0.127E-21	P(28) C
6	3078.063 53(33)	837.16	0.843E-22	P(39) B	41	3083.353 46(27)	176.45	0.778E-21	P(29) A
7	3078.354 19(32)	837.49	0.842E-22	P(39) C	42	3083.471 28(31)	673.94	0.129E-21	P(27) B
8	3078.498 86(28)	332.57	0.501E-21	P(40) A	43	3083.605 60(31)	674.10	0.129E-21	P(27) C
9	3078.521 50(33)	821.33	0.887E-22	P(38) B	44	3083.788 83(27)	164.69	0.796E-21	P(28) A
10	3078.796 89(32)	821.64	0.886E-22	P(38) C	45	3083.913 21(31)	662.98	0.131E-21	P(26) B
11	3078.945 05(27)	316.35	0.528E-21	P(39) A	46	3084.037 16(31)	663.13	0.131E-21	P(26) C
12	3078.978 15(32)	805.90	0.931E-22	P(37) B	47	3084.223 19(27)	153.34	0.811E-21	P(27) A
13	3079.238 67(32)	806.20	0.930E-22	P(37) C	48	3084.353 78(31)	652.42	0.133E-21	P(25) B
14	3079.390 28(27)	300.54	0.556E-21	P(38) A	49	3084.467 78(30)	652.56	0.133E-21	P(25) C
15	3079.433 47(32)	790.88	0.975E-22	P(36) B	50	3084.656 54(27)	142.38	0.824E-21	P(26) A
16	3079.679 53(31)	791.16	0.974E-22	P(36) C	51	3084.792 99(31)	642.27	0.134E-21	P(24) B
17	3079.834 55(27)	285.13	0.584E-21	P(37) A	52	3084.897 47(30)	642.40	0.134E-21	P(24) C
18	3079.887 47(32)	776.26	0.102E-21	P(35) B	53	3085.088 86(27)	131.84	0.834E-21	P(25) A
19	3080.119 47(31)	776.53	0.102E-21	P(35) C	54	3085.230 85(30)	632.52	0.135E-21	P(23) B
20	3080.277 86(27)	270.13	0.611E-21	P(36) A	55	3085.326 20(30)	632.64	0.135E-21	P(23) C
21	3080.340 13(32)	762.05	0.106E-21	P(34) B	56	3085.514 87(69)	67.68	0.354E-22	P(18) P
22	3080.558 49(31)	762.31	0.106E-21	P(34) C	57	3085.520 15(27)	121.70	0.841E-21	P(24) A
23	3080.720 19(27)	255.53	0.638E-21	P(35) A	58	3085.667 35(30)	623.18	0.135E-21	P(22) B
24	3080.791 46(32)	748.25	0.110E-21	P(33) B	59	3085.753 99(29)	623.29	0.135E-21	P(22) C
25	3080.996 58(31)	748.49	0.110E-21	P(33) C	60	3085.950 42(27)	111.96	0.845E-21	P(23) A
26	3081.161 54(27)	241.34	0.665E-21	P(34) A	61	3086.102 49(29)	614.25	0.134E-21	P(21) B
27	3081.241 45(32)	734.85	0.114E-21	P(32) B	62	3086.180 84(29)	614.35	0.134E-21	P(21) C
28	3081.433 75(31)	735.07	0.114E-21	P(32) C	63	3086.375 06(39)	935.82	0.134E-22	R(19) D
29	3081.601 91(27)	227.55	0.690E-21	P(33) A	64	3086.379 64(27)	102.63	0.846E-21	P(22) A
30	3081.690 11(32)	721.86	0.118E-21	P(31) B	65	3086.536 27(29)	605.72	0.133E-21	P(20) B
31	3081.869 98(31)	722.07	0.117E-21	P(31) C	66	3086.606 73(29)	605.81	0.133E-21	P(20) C
32	3082.041 30(27)	214.17	0.714E-21	P(32) A	67	3086.807 83(27)	93.71	0.844E-21	P(21) A
33	3082.137 42(32)	709.27	0.121E-21	P(30) B	68	3086.968 68(29)	597.60	0.132E-21	P(19) B
34	3082.305 29(31)	709.47	0.121E-21	P(30) C	69	3087.031 68(28)	597.68	0.132E-21	P(19) C
35	3082.479 68(27)	201.19	0.737E-21	P(31) A	70	3087.234 98(27)	85.19	0.838E-21	P(20) A

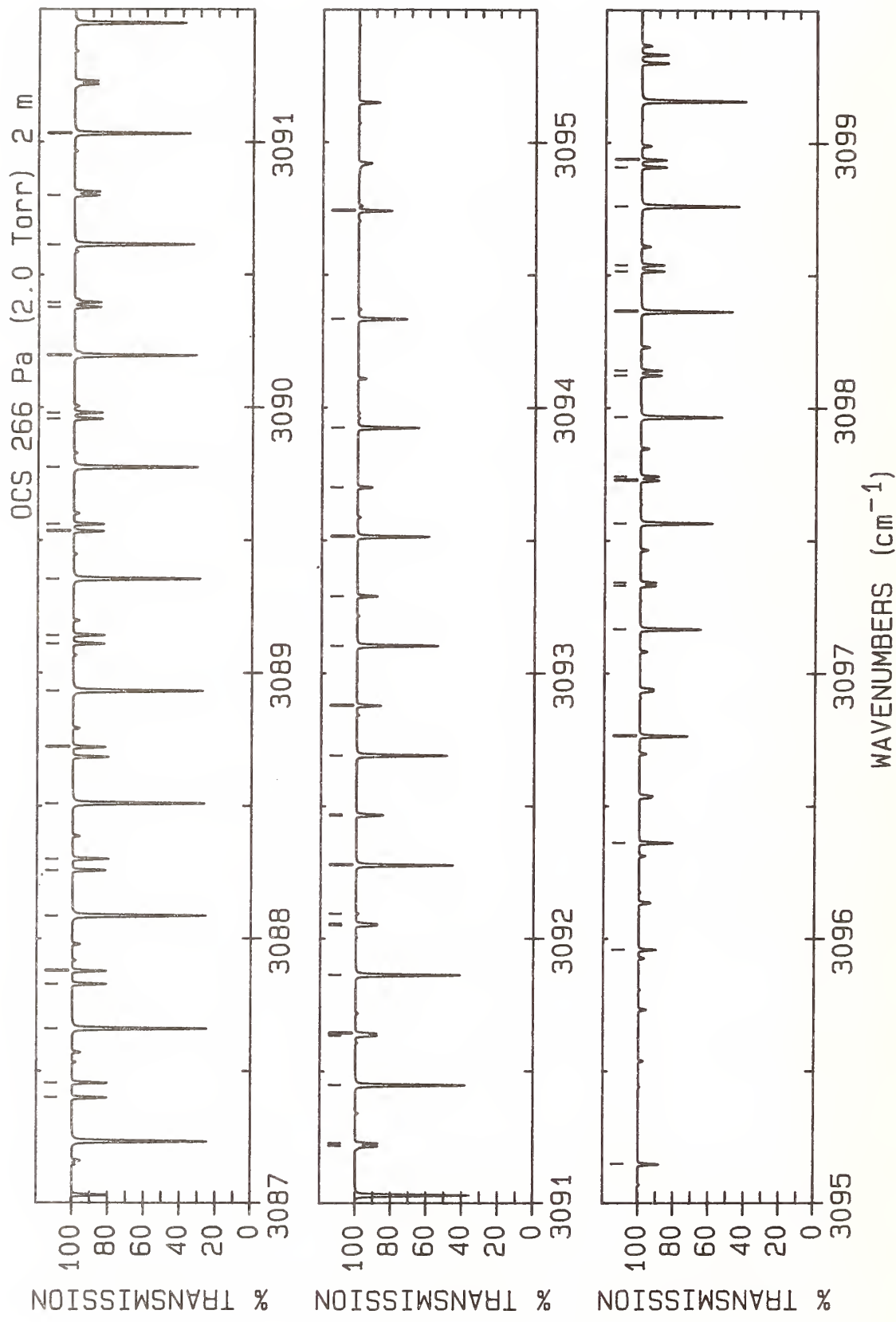

LINE #	WAVENUMBER(cm^{-1})	LOWER STATE (cm^{-1})	INTENSITY ($\text{cm}/\text{molecule}$)	ASSIGNMENT ROTATION BAND	LINE #	WAVENUMBER(cm^{-1})	LOWER STATE (cm^{-1})	INTENSITY ($\text{cm}/\text{molecule}$)	ASSIGNMENT ROTATION BAND
1	3087.399 73(28)	589.88	0.130E-21	P(18) B	36	3092.465 16(33)	528.95	0.567E-22	P(6) B
2	3087.455 67(28)	589.95	0.129E-21	P(18) C	37	3092.468 85(33)	528.96	0.567E-22	P(6) C
3	3087.661 08(28)	77.08	0.828E-21	P(19) A	38	3092.468 97(38)	1113.73	0.101E-22	R(35) D
4	3087.829 41(28)	582.57	0.127E-21	P(17) B	39	3092.691 56(29)	11.36	0.421E-21	P(7) A
5	3087.878 71(28)	582.63	0.127E-21	P(17) C	40	3092.878 31(34)	526.51	0.472E-22	P(5) B
6	3088.086 13(28)	69.37	0.815E-21	P(18) A	41	3092.880 35(34)	526.52	0.472E-22	P(5) C
7	3088.257 72(28)	575.66	0.123E-21	P(16) B	42	3093.103 79(29)	8.52	0.366E-21	P(6) A
8	3088.300 80(28)	575.72	0.123E-21	P(16) C	43	3093.290 08(34)	524.48	0.373E-22	P(4) B
9	3088.510 13(28)	62.07	0.797E-21	P(17) A	44	3093.290 87(34)	524.49	0.373E-22	P(4) C
10	3088.721 93(28)	569.22	0.119E-21	P(15) C	45	3093.514 95(29)	6.09	0.308E-21	P(5) A
11	3088.933 07(28)	55.17	0.776E-21	P(16) A	46	3093.700 43(35)	522.86	0.267E-22	P(3) C
12	3089.110 22(29)	563.07	0.115E-21	P(14) B	47	3093.700 45(35)	522.86	0.267E-22	P(3) B
13	3089.142 10(29)	563.12	0.115E-21	P(14) C	48	3093.925 01(29)	4.06	0.249E-21	P(4) A
14	3089.354 96(28)	48.68	0.751E-21	P(15) A	49	3094.333 99(29)	2.43	0.188E-21	P(3) A
15	3089.534 41(29)	557.38	0.109E-21	P(13) B	50	3094.741 88(29)	1.22	0.126E-21	P(2) A
16	3089.561 32(29)	557.42	0.109E-21	P(13) C	51	3095.148 69(29)	0.41	0.634E-22	P(1) A
17	3089.775 78(28)	42.60	0.722E-21	P(14) A	52	3095.150 21(86)	5.94	0.160E-22	R(5) P
18	3089.957 23(30)	552.11	0.104E-21	P(12) B	53	3095.959 02(29)	0.00	0.636E-22	R(0) A
19	3089.979 57(30)	552.14	0.104E-21	P(12) C	54	3096.362 55(29)	0.41	0.127E-21	R(1) A
20	3090.195 53(28)	36.92	0.689E-21	P(13) A	55	3096.764 99(29)	1.22	0.190E-21	R(2) A
21	3090.378 67(30)	547.23	0.970E-22	P(11) B	56	3097.166 33(29)	2.43	0.251E-21	R(3) A
22	3090.396 86(30)	547.26	0.970E-22	P(11) C	57	3097.331 23(33)	526.51	0.575E-22	R(5) B
23	3090.614 22(28)	31.64	0.653E-21	P(12) A	58	3097.342 51(33)	526.52	0.575E-22	R(5) C
24	3090.798 73(31)	542.76	0.900E-22	P(10) B	59	3097.566 58(29)	4.06	0.312E-21	R(4) A
25	3091.031 84(28)	26.78	0.613E-21	P(11) A	60	3097.727 67(32)	528.95	0.668E-22	R(6) B
26	3091.217 41(32)	538.70	0.824E-22	P(9) B	61	3097.742 29(32)	528.96	0.668E-22	R(6) C
27	3091.228 56(32)	538.72	0.824E-22	P(9) C	62	3097.965 74(29)	6.09	0.370E-21	R(5) A
28	3091.448 38(28)	22.31	0.570E-21	P(10) A	63	3098.122 72(32)	531.80	0.757E-22	R(7) B
29	3091.634 71(32)	535.04	0.743E-22	P(8) B	64	3098.141 08(32)	531.81	0.757E-22	R(7) C
30	3091.642 96(32)	535.06	0.743E-22	P(8) C	65	3098.363 80(29)	8.52	0.427E-21	R(6) A
31	3091.863 85(28)	18.26	0.523E-21	P(9) A	66	3098.516 37(31)	535.04	0.841E-22	R(8) B
32	3092.050 63(33)	531.80	0.658E-22	P(7) B	67	3098.538 90(31)	535.06	0.841E-22	R(8) C
33	3092.056 39(33)	531.81	0.658E-22	P(7) C	68	3098.760 77(28)	11.36	0.482E-21	R(7) A
34	3092.094 11(38)	1099.58	0.106E-22	R(34) D	69	3098.908 62(30)	538.70	0.920E-22	R(9) B
35	3092.278 25(29)	14.61	0.473E-21	P(8) A	70	3098.935 72(30)	538.72	0.920E-22	R(9) C

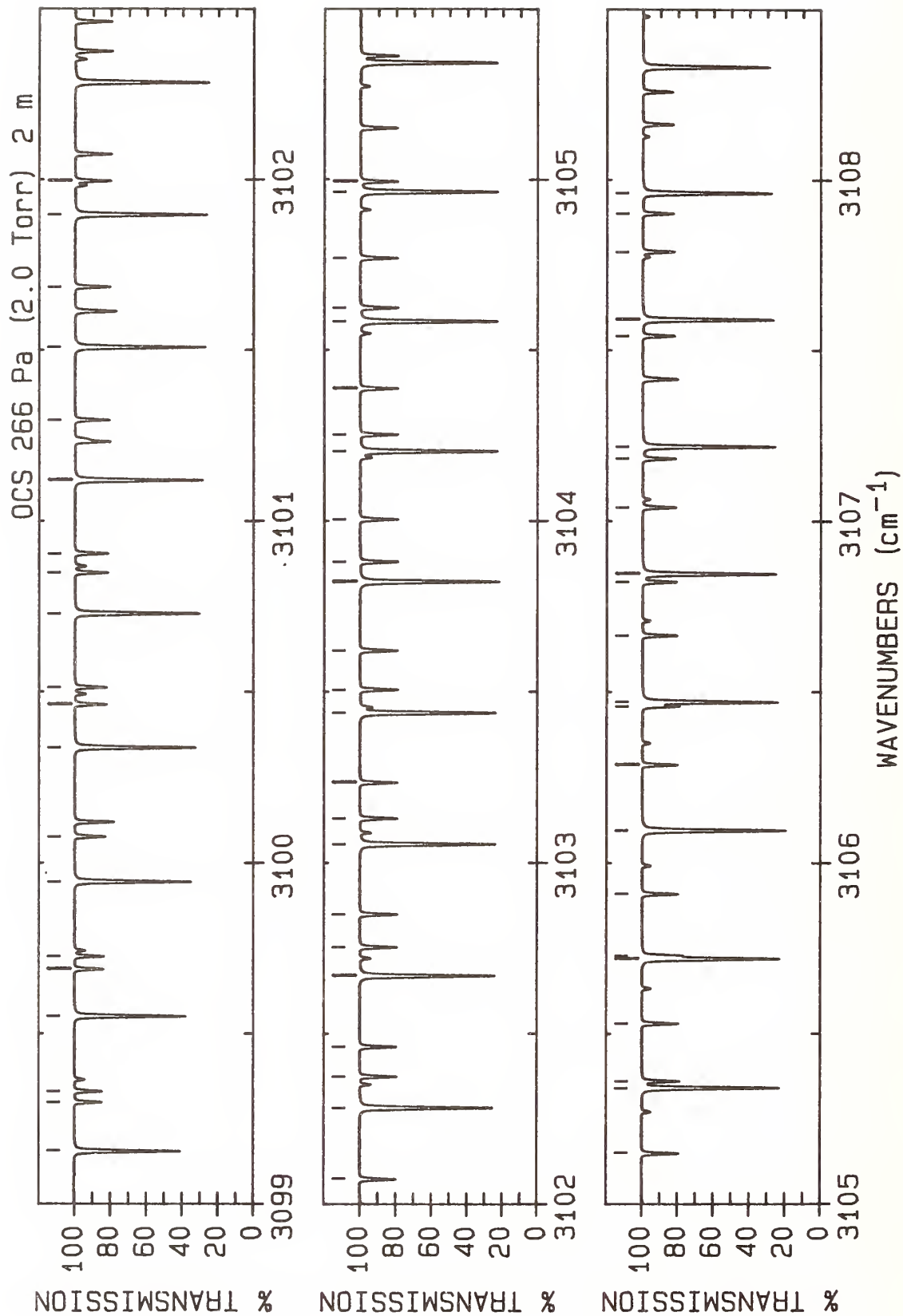

LINE #	WAVENUMBER(cm ⁻¹)	LOWER STATE (cm ⁻¹)	INTENSITY (cm/molecule)	ASSIGNMENT ROTATION BAND	LINE #	WAVENUMBER(unc) (cm ⁻¹)	LOWER STATE (cm ⁻¹)	INTENSITY (cm/molecule)	ASSIGNMENT ROTATION BAND
1	3099.156 64(28)	14.61	0.533E-21	R(8) A	36	3103.880 17(31)	623.18	0.142E-21	R(22) B
2	3099.299 47(30)	542.76	0.994E-22	R(10) B	37	3104.004 58(30)	623.29	0.142E-21	R(22) C
3	3099.331 57(30)	542.79	0.994E-22	R(10) C	38	3104.203 56(27)	93.71	0.889E-21	R(21) A
4	3099.551 42(28)	18.26	0.582E-21	R(9) A	39	3104.252 76(31)	632.52	0.141E-21	R(23) B
5	3099.688 91(29)	547.23	0.106E-21	R(11) B	40	3104.387 55(30)	632.64	0.141E-21	R(23) C
6	3099.726 42(29)	547.26	0.106E-21	R(11) C	41	3104.584 17(27)	102.63	0.890E-21	R(22) A
7	3099.945 10(28)	22.31	0.628E-21	R(10) A	42	3104.623 95(31)	642.27	0.141E-21	R(24) B
8	3100.076 96(29)	552.11	0.113E-21	R(12) B	43	3104.769 53(31)	642.40	0.140E-21	R(24) C
9	3100.337 69(28)	26.78	0.671E-21	R(11) A	44	3104.963 71(27)	111.96	0.887E-21	R(23) A
10	3100.463 60(28)	557.38	0.118E-21	R(13) B	45	3104.993 72(31)	652.42	0.139E-21	R(25) B
11	3100.513 18(28)	557.42	0.118E-21	R(13) C	46	3105.150 51(31)	652.56	0.139E-21	R(25) C
12	3100.729 18(28)	31.64	0.710E-21	R(12) A	47	3105.342 16(27)	121.70	0.882E-21	R(24) A
13	3100.848 84(28)	563.07	0.123E-21	R(14) B	48	3105.362 09(31)	662.98	0.137E-21	R(26) B
14	3100.905 07(28)	563.12	0.123E-21	R(14) C	49	3105.530 50(31)	663.13	0.137E-21	R(26) C
15	3101.119 58(28)	36.92	0.745E-21	R(13) A	50	3105.719 54(27)	131.84	0.873E-21	R(25) A
16	3101.295 98(28)	569.22	0.128E-21	R(15) C	51	3105.729 06(32)	673.94	0.135E-21	R(27) B
17	3101.508 89(28)	42.60	0.776E-21	R(14) A	52	3105.909 50(31)	674.10	0.135E-21	R(27) C
18	3101.685 90(28)	575.72	0.132E-21	R(16) C	53	3106.094 62(32)	685.31	0.132E-21	R(28) B
19	3101.897 11(28)	48.68	0.804E-21	R(15) A	54	3106.095 84(27)	142.38	0.861E-21	R(26) A
20	3101.996 13(29)	582.57	0.135E-21	R(17) B	55	3106.287 50(31)	685.49	0.132E-21	R(28) C
21	3102.074 82(28)	582.63	0.135E-21	R(17) C	56	3106.458 77(32)	697.09	0.129E-21	R(29) B
22	3102.284 24(28)	55.17	0.828E-21	R(16) A	57	3106.471 08(27)	153.34	0.847E-21	R(27) A
23	3102.375 75(29)	589.88	0.138E-21	R(18) B	58	3106.664 50(31)	697.27	0.129E-21	R(29) C
24	3102.462 76(29)	589.95	0.137E-21	R(18) C	59	3106.821 51(32)	709.27	0.126E-21	R(30) B
25	3102.670 28(28)	62.07	0.848E-21	R(17) A	60	3106.845 24(27)	164.69	0.830E-21	R(28) A
26	3102.753 96(29)	597.60	0.139E-21	R(19) B	61	3107.040 51(31)	709.47	0.126E-21	R(30) C
27	3102.849 70(29)	597.68	0.139E-21	R(19) C	62	3107.182 85(32)	721.86	0.122E-21	R(31) B
28	3103.055 23(27)	69.37	0.864E-21	R(18) A	63	3107.218 35(27)	176.45	0.811E-21	R(29) A
29	3103.130 77(30)	605.72	0.141E-21	R(20) B	64	3107.542 79(32)	734.85	0.118E-21	R(32) B
30	3103.235 65(29)	605.81	0.141E-21	R(20) C	65	3107.590 38(27)	188.62	0.790E-21	R(30) A
31	3103.439 09(27)	77.08	0.876E-21	R(19) A	66	3107.789 54(31)	735.07	0.118E-21	R(32) C
32	3103.506 18(30)	614.25	0.141E-21	R(21) B	67	3107.901 32(32)	748.25	0.114E-21	R(33) B
33	3103.620 61(30)	614.35	0.141E-21	R(21) C	68	3107.961 36(27)	201.19	0.767E-21	R(31) A
34	3103.820 75(66)	160.67	0.365E-22	R(28) P					
35	3103.821 87(27)	85.19	0.884E-21	R(20) A					

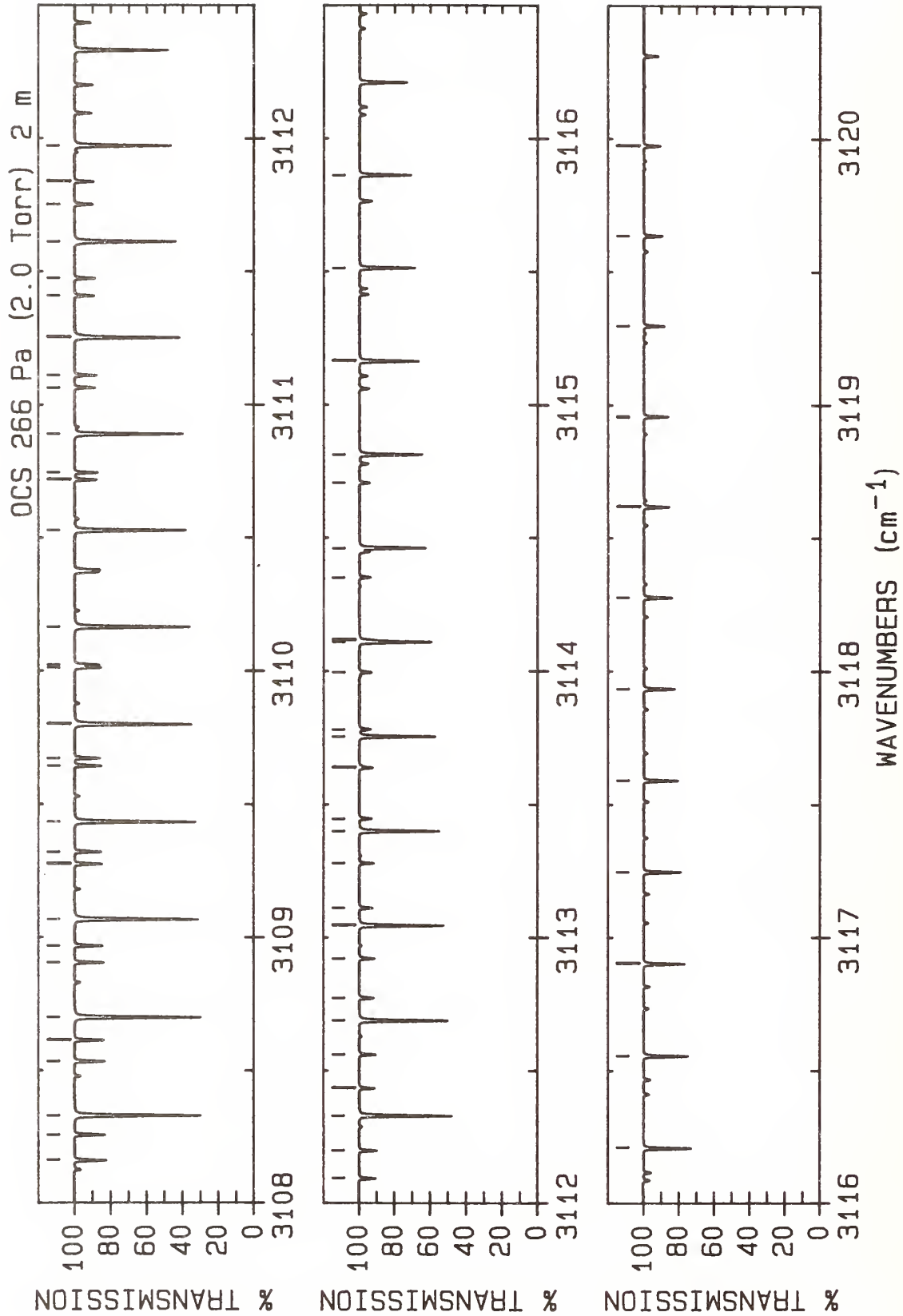

LINE #	WAVENUMBER(unc) (cm ⁻¹)	LOWER STATE (cm ⁻¹)	INTENSITY (cm/molecule)	ASSIGNMENT ROTATION BAND	LINE #	WAVENUMBER(unc) (cm ⁻¹)	LOWER STATE (cm ⁻¹)	INTENSITY (cm/molecule)	ASSIGNMENT ROTATION BAND
1	3108.162 56(31)	748.49	0.114E-21	R(33) C	36	3112.561 12(40)	941.10	0.606E-22	R(45) C
2	3108.258 44(32)	762.05	0.110E-21	R(34) B	37	3112.689 22(29)	401.49	0.407E-21	R(44) A
3	3108.331 28(27)	214.17	0.743E-21	R(32) A	38	3112.773 79(47)	978.40	0.528E-22	R(47) B
4	3108.534 58(31)	762.31	0.110E-21	R(34) C	39	3112.921 20(44)	959.78	0.566E-22	R(46) C
5	3108.614 16(32)	776.26	0.106E-21	R(35) B	40	3113.045 75(29)	419.73	0.380E-21	R(45) A
6	3108.700 15(27)	227.55	0.717E-21	R(33) A	41	3113.111 39(53)	997.88	0.490E-22	R(48) B
7	3108.905 61(32)	776.53	0.106E-21	R(35) C	42	3113.280 29(49)	978.88	0.527E-22	R(47) C
8	3108.968 48(33)	790.88	0.101E-21	R(36) B	43	3113.401 27(29)	438.37	0.355E-21	R(46) A
9	3109.067 97(27)	241.34	0.690E-21	R(34) A	44	3113.447 60(60)	1017.76	0.454E-22	R(49) B
10	3109.275 64(32)	791.16	0.101E-21	R(36) C	45	3113.638 39(55)	998.38	0.489E-22	R(48) C
11	3109.321 40(33)	805.90	0.966E-22	R(37) B	46	3113.755 81(29)	457.42	0.330E-21	R(47) A
12	3109.434 74(27)	255.53	0.662E-21	R(35) A	47	3113.782 44(70)	1038.05	0.420E-22	R(50) B
13	3109.644 67(32)	806.20	0.965E-22	R(37) C	48	3113.995 49(64)	1018.28	0.453E-22	R(49) C
14	3109.672 92(34)	821.33	0.920E-22	R(38) B	49	3114.109 35(30)	476.88	0.307E-21	R(48) A
15	3109.800 47(27)	270.13	0.634E-21	R(36) A	50	3114.115 90(82)	1058.74	0.387E-22	R(51) B
16	3110.012 71(33)	821.64	0.918E-22	R(38) C	51	3114.351 61(74)	1038.59	0.419E-22	R(50) C
17	3110.023 04(34)	837.16	0.874E-22	R(39) B	52	3114.461 91(30)	496.74	0.284E-21	R(49) A
18	3110.165 15(27)	285.13	0.605E-21	R(37) A	53	3114.706 73(87)	1059.31	0.386E-22	R(51) C
19	3110.528 81(28)	300.54	0.576E-21	R(38) A	54	3114.813 49(30)	517.00	0.262E-21	R(50) A
20	3110.719 09(35)	870.04	0.782E-22	R(41) B	55	3115.164 09(30)	537.67	0.242E-21	R(51) A
21	3110.745 80(34)	853.74	0.826E-22	R(40) C	56	3115.513 73(31)	558.74	0.222E-21	R(52) A
22	3110.891 43(28)	316.35	0.547E-21	R(39) A	57	3115.862 40(31)	580.22	0.204E-21	R(53) A
23	3111.065 01(36)	887.08	0.737E-22	R(42) B	58	3116.210 12(31)	602.10	0.187E-21	R(54) A
24	3111.110 86(34)	870.40	0.781E-22	R(41) C	59	3116.556 89(31)	624.39	0.170E-21	R(55) A
25	3111.253 03(28)	332.57	0.518E-21	R(40) A	60	3116.902 71(31)	647.08	0.155E-21	R(56) A
26	3111.409 55(36)	904.54	0.693E-22	R(43) B	61	3117.247 59(32)	670.17	0.141E-21	R(57) A
27	3111.474 91(35)	887.47	0.736E-22	R(42) C	62	3117.591 54(32)	693.67	0.128E-21	R(58) A
28	3111.613 60(28)	349.19	0.490E-21	R(41) A	63	3117.934 56(33)	717.57	0.116E-21	R(59) A
29	3111.752 69(37)	922.39	0.649E-22	R(44) B	64	3118.276 66(34)	741.87	0.104E-21	R(60) A
30	3111.837 98(36)	904.94	0.692E-22	R(43) C	65	3118.617 85(36)	766.58	0.941E-22	R(61) A
31	3111.973 15(28)	366.22	0.461E-21	R(42) A	66	3118.955 3	1417.69	0.869E-23	R(66) B
32	3112.094 45(39)	940.66	0.608E-22	R(45) B	67	3118.958 12(38)	791.70	0.846E-22	R(62) A
33	3112.200 04(38)	922.82	0.648E-22	R(44) C	68	3119.297 49(41)	817.21	0.758E-22	R(63) A
34	3112.331 69(28)	383.65	0.434E-21	R(43) A	69	3119.635 97(44)	843.13	0.678E-22	R(64) A
35	3112.434 81(42)	959.33	0.567E-22	R(46) B	70	3119.973 55(48)	869.46	0.605E-22	R(65) A

Energy Levels for N₂O

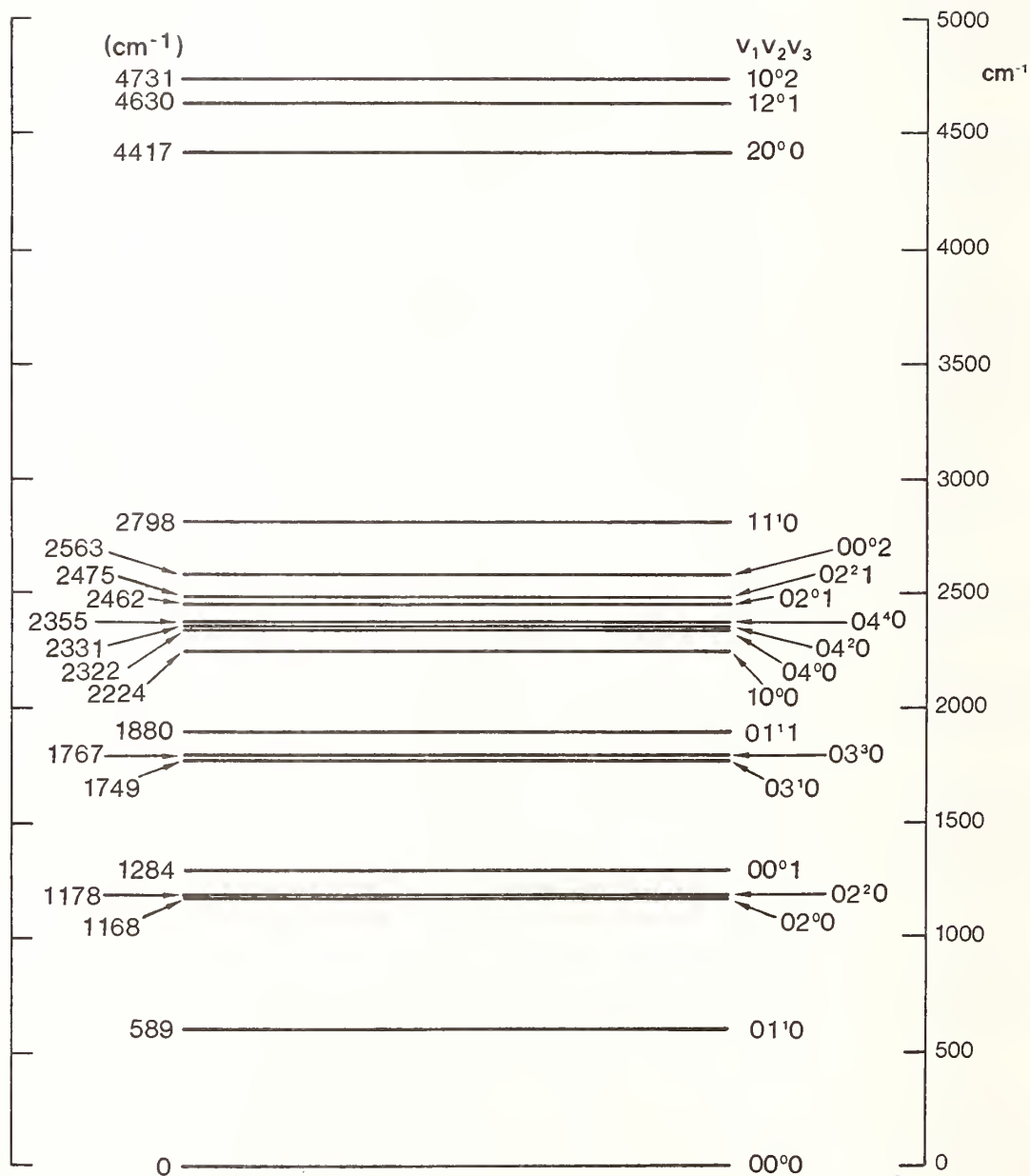

ATLAS OF N₂O ABSORPTION LINES FROM 523 cm⁻¹ to 659 cm⁻¹

key:

Band	Isotopomer	Vibrational Transition
A	¹⁴ N ¹⁴ N ¹⁶ O	01 ¹ 0-00 ⁰ 0
B		02 ² 0-01 ^{1e} 0
C		02 ² 0-01 ^{1f} 0
D		01 ¹¹ -00 ⁰ 1
E		03 ³ 0-02 ^{2e} 0
F		03 ³ 0-02 ^{2f} 0
G		03 ¹ 0-02 ⁰ 0
H		02 ⁰ 0-01 ¹ 0
I		03 ¹ 0-02 ^{2e} 0
J		03 ¹ 0-02 ^{2f} 0
P	¹⁴ N ¹⁵ N ¹⁶ O	01 ¹ 0-00 ⁰ 0
R	¹⁵ N ¹⁴ N ¹⁶ O	01 ¹ 0-00 ⁰ 0
T	¹⁴ N ¹⁴ N ¹⁸ O	01 ¹ 0-00 ⁰ 0

If the e or f designation is not specified (for $l \neq 0$), then the transition is to either level, depending on the selection rules and the change in the rotational quantum number, J . Spectra are given for a slitwidth of 0.002 cm⁻¹ and a transition moment of 0.0692 debye at a temperature of 296 K. A Herman-Wallis constant of $a_1 = 0.0016$ is included in the intensity calculation for the lines of all the bands.

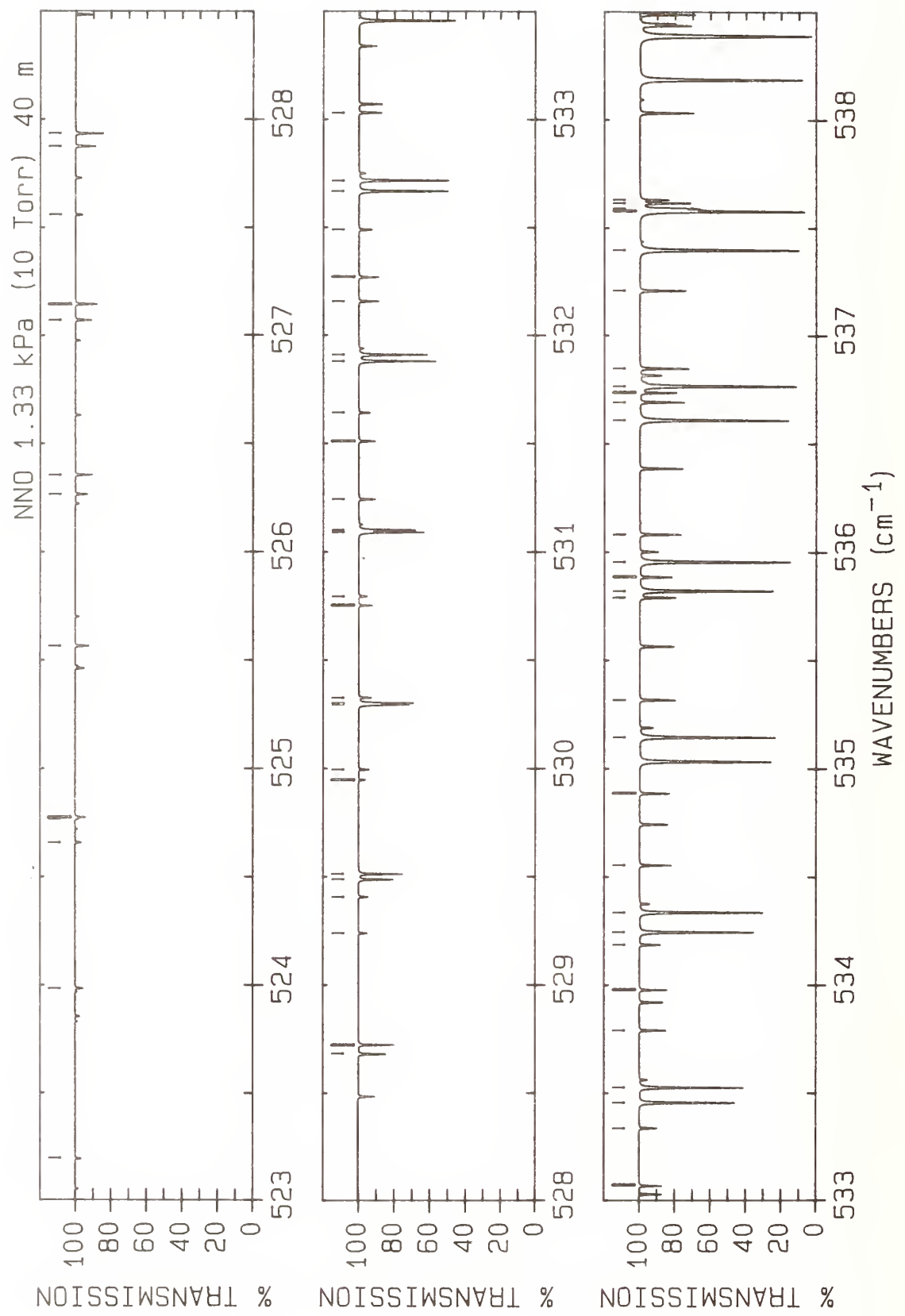

LINE #	WAVENUMBER(unc) (cm ⁻¹)	LOWER STATE (cm ⁻¹)	INTENSITY (cm/molecule)	ASSIGNMENT ROTATION BAND	LINE #	WAVENUMBER(unc) (cm ⁻¹)	LOWER STATE (cm ⁻¹)	INTENSITY (cm/molecule)	ASSIGNMENT ROTATION BAND
1	523.194 27(22)*	2667.68	0.173E-24	P(70) H	36	532.490 29(14)	2553.77	0.402E-24	P(57) G
2	523.985 23(21)*	2609.24	0.226E-24	P(69) H	37	532.668 33(15)*	2021.11	0.327E-23	P(58) H
3	524.659 12(27)	2575.26	0.186E-24	P(78) A	38	532.718 15(17)*	1962.12	0.337E-23	P(68) A
4	524.767 77(11)	2379.09	0.102E-24	P(53) I	39	533.030 70(14)	2164.88	0.659E-24	P(48) J
5	524.775 88(20)*	2551.62	0.295E-24	P(68) H	40	533.070 26(9)	2009.10	0.670E-24	P(44) I
6	525.566 21(19)*	2494.84	0.383E-24	P(67) H	41	533.338 49(14)	2506.08	0.498E-24	P(56) G
7	526.266 87(24)	2446.02	0.344E-24	P(76) A	42	533.456 65(14)*	1972.62	0.406E-23	P(57) H
8	526.356 25(19)*	2438.88	0.494E-24	P(66) H	43	533.526 83(17)*	1905.36	0.440E-23	P(67) A
9	527.071 51(23)	2382.64	0.464E-24	P(75) A	44	533.791 91(13)	2124.63	0.782E-24	P(47) J
10	527.146 02(18)*	2383.76	0.636E-24	P(65) H	45	533.979 41(9)	1972.17	0.805E-24	P(43) I
11	527.560 22(10)	2248.24	0.200E-24	P(50) I	46	534.187 15(14)	2459.21	0.616E-24	P(55) G
12	527.876 65(22)	2320.08	0.623E-24	P(74) A	47	534.244 89(14)*	1924.97	0.501E-23	P(56) H
13	527.935 53(17)*	2329.46	0.814E-24	P(64) H	48	534.336 01(16)*	1849.42	0.571E-23	P(66) A
14	528.682 31(21)	2258.36	0.835E-24	P(73) A	49	534.554 26(12)	2085.21	0.924E-24	P(46) J
15	528.724 80(17)*	2275.99	0.104E-23	P(63) H	50	534.886 06(9)	1936.08	0.963E-24	P(42) I
16	529.240 27(25)	2378.66	0.263E-24	P(53) J	51	535.145 69(15)*	1794.32	0.739E-23	P(65) A
17	529.407 71(10)	2165.18	0.306E-24	P(48) I	52	535.317 78(11)	2046.63	0.109E-23	P(45) J
18	529.488 47(20)	2197.45	0.111E-23	P(72) A	53	535.790 26(9)	1900.83	0.115E-23	P(41) I
19	529.513 85(16)*	2223.36	0.132E-23	P(62) H	54	535.821 29(13)*	1832.15	0.755E-23	P(54) H
20	529.948 66(16)	2701.85	0.205E-24	P(60) G	55	535.885 83(13)	2367.97	0.925E-24	P(53) G
21	529.996 40(23)	2334.23	0.319E-24	P(52) J	56	535.955 88(15)*	1740.04	0.953E-23	P(64) A
22	530.295 13(20)	2137.38	0.148E-23	P(71) A	57	536.082 50(10)	2008.88	0.127E-23	P(44) J
23	530.302 71(16)*	2171.55	0.166E-23	P(61) H	58	536.609 50(13)*	1786.99	0.921E-23	P(53) H
24	530.327 33(10)	2124.90	0.375E-24	P(47) I	59	536.692 06(9)	1866.41	0.136E-23	P(40) I
25	530.753 47(20)	2290.64	0.385E-24	P(51) J	60	536.735 82(13)	2323.60	0.113E-23	P(52) G
26	530.795 37(15)	2651.66	0.258E-24	P(59) G	61	536.766 56(14)*	1686.59	0.122E-22	P(63) A
27	531.091 39(15)*	2120.57	0.209E-23	P(60) H	62	536.848 47(10)	1971.97	0.149E-23	P(43) J
28	531.102 30(19)*	2078.13	0.195E-23	P(70) A	63	537.209 36(38)	905.01	0.154E-23	P(46) P
29	531.244 27(9)	2085.47	0.457E-24	P(46) I	64	537.397 76(13)*	1742.67	0.112E-22	P(52) H
30	531.511 52(18)	2247.89	0.462E-24	P(50) J	65	537.577 73(14)*	1633.97	0.156E-22	P(62) A
31	531.642 58(15)	2602.30	0.323E-24	P(58) G	66	537.586 21(13)	2280.07	0.137E-23	P(51) G
32	531.879 92(15)*	2070.42	0.262E-23	P(59) H	67	537.591 51(9)	1832.84	0.160E-23	P(39) I
33	531.909 97(18)*	2019.71	0.257E-23	P(69) A	68	537.615 72(9)	1935.90	0.172E-23	P(42) J
34	532.158 57(9)	2046.86	0.555E-24	P(45) I	69	537.630 85(63)	2226.43	0.850E-24	P(62) C
35	532.270 58(16)	2205.96	0.553E-24	P(49) J					

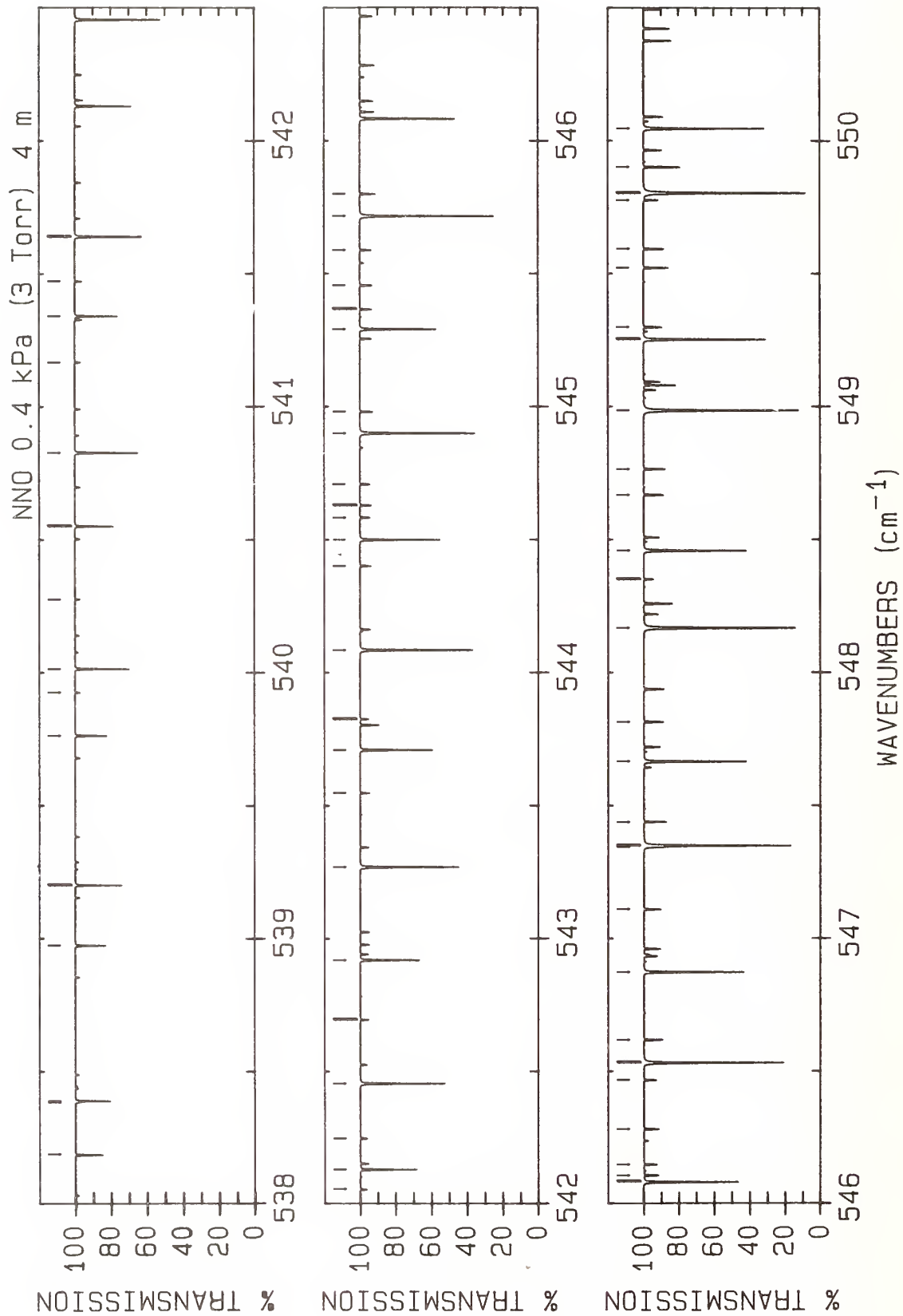

LINE #	WAVENUMBER(unc) (cm ⁻¹)	LOWER STATE (cm ⁻¹)	INTENSITY (cm/molecule)	ASSIGNMENT ROTATION BAND	LINE #	WAVENUMBER(unc) (cm ⁻¹)	LOWER STATE (cm ⁻¹)	INTENSITY (cm/molecule)	ASSIGNMENT ROTATION BAND
1	538.186 11(12)*	1699.17	0.135E-22	P(51) H	36	545.456 17(17)	557.77	0.680E-23	P(36) P
2	538.384 28(9)	1900.66	0.199E-23	P(41) J	37	545.589 11(9)	1568.36	0.548E-23	P(30) I
3	538.389 41(13)*	1582.18	0.199E-22	P(61) A	38	545.716 63(10)*	1153.46	0.142E-21	P(52) A
4	538.974 58(12)*	1656.51	0.162E-22	P(50) H	39	545.799 82(20)	1744.84	0.774E-23	P(52) C
5	539.201 58(13)*	1531.22	0.252E-22	P(60) A	40	546.082 24(11)*	1310.06	0.700E-22	P(41) H
6	539.763 20(12)*	1614.68	0.195E-22	P(49) H	41	546.108 01(11)	1890.51	0.731E-23	P(41) G
7	539.925 48(9)	1832.70	0.263E-23	P(39) J	42	546.149 01(9)	1594.33	0.665E-23	P(31) J
8	540.014 24(12)*	1481.09	0.317E-22	P(59) A	43	546.282 95(16)	527.64	0.769E-23	P(35) P
9	540.276 25(9)	1737.13	0.252E-23	P(36) I	44	546.467 83(9)	1543.16	0.611E-23	P(29) I
10	540.552 01(12)*	1573.69	0.232E-22	P(48) H	45	546.533 21(9)*	1109.98	0.173E-21	P(51) A
11	540.827 40(12)*	1431.79	0.398E-22	P(58) A	46	546.619 27(18)	1701.27	0.942E-23	P(51) C
12	541.166 80(9)	1706.91	0.291E-23	P(35) I	47	546.873 96(11)*	1275.74	0.805E-22	P(40) H
13	541.341 05(12)*	1533.53	0.275E-22	P(47) H	48	547.110 11(15)	498.34	0.866E-23	P(34) P
14	541.472 32(9)	1768.08	0.341E-23	P(37) J	49	547.344 75(9)	1518.81	0.679E-23	P(28) I
15	541.641 05(11)*	1383.33	0.498E-22	P(57) A	50	547.350 26(9)*	1067.33	0.210E-21	P(50) A
16	542.055 25(9)	1677.52	0.334E-23	P(34) I	51	547.439 18(16)	1658.53	0.114E-22	P(50) C
17	542.130 36(12)*	1494.20	0.325E-22	P(46) H	52	547.666 23(11)*	1242.25	0.921E-22	P(39) H
18	542.247 93(9)	1737.03	0.385E-23	P(36) J	53	547.815 05(11)	1822.61	0.967E-23	P(39) G
19	542.455 19(11)*	1335.69	0.620E-22	P(56) A	54	548.167 80(9)*	1025.52	0.254E-21	P(49) A
20	542.696 01(12)	2036.33	0.395E-23	P(45) G	55	548.351 69(11)	1742.67	0.490E-23	P(52) B
21	542.919 97(12)*	1455.70	0.383E-22	P(45) H	56	548.459 09(11)*	1209.60	0.105E-21	P(38) H
22	543.269 82(11)*	1288.88	0.768E-22	P(55) A	57	548.668 73(11)	1789.92	0.110E-22	P(38) G
23	543.548 69(12)	1998.62	0.463E-23	P(44) G	58	548.765 52(14)	442.25	0.108E-22	P(32) P
24	543.709 92(12)*	1418.04	0.448E-22	P(44) H	59	548.985 81(9)*	984.54	0.304E-21	P(48) A
25	543.826 07(9)	1621.26	0.432E-23	P(32) I	60	549.252 57(11)*	1177.78	0.119E-21	P(37) H
26	544.084 94(10)*	1242.91	0.947E-22	P(54) A	61	549.299 01(9)	1495.26	0.945E-23	P(27) J
27	544.401 59(12)	1961.75	0.542E-23	P(43) G	62	549.522 49(11)	1758.06	0.125E-22	P(37) G
28	544.500 26(11)*	1381.21	0.522E-22	P(43) H	63	549.593 77(14)	415.46	0.119E-22	P(31) P
29	544.583 86(9)	1648.90	0.542E-23	P(33) J	64	549.777 36(10)	1656.51	0.749E-23	P(50) B
30	544.629 77(19)	588.74	0.599E-23	P(37) P	65	549.804 30(9)*	944.39	0.364E-21	P(47) A
31	544.708 54(9)	1594.39	0.488E-23	P(31) I	66	549.804 46(25)	782.62	0.143E-23	P(44) T
32	544.900 55(10)*	1197.77	0.116E-21	P(53) A	67	549.901 69(12)	1535.31	0.198E-22	P(47) C
33	544.980 83(22)	1789.25	0.633E-23	P(53) C	68	550.046 72(11)*	1146.80	0.134E-21	P(36) H
34	545.291 02(11)*	1345.22	0.606E-22	P(42) H					
35	545.365 63(9)	1621.19	0.601E-23	P(32) J					

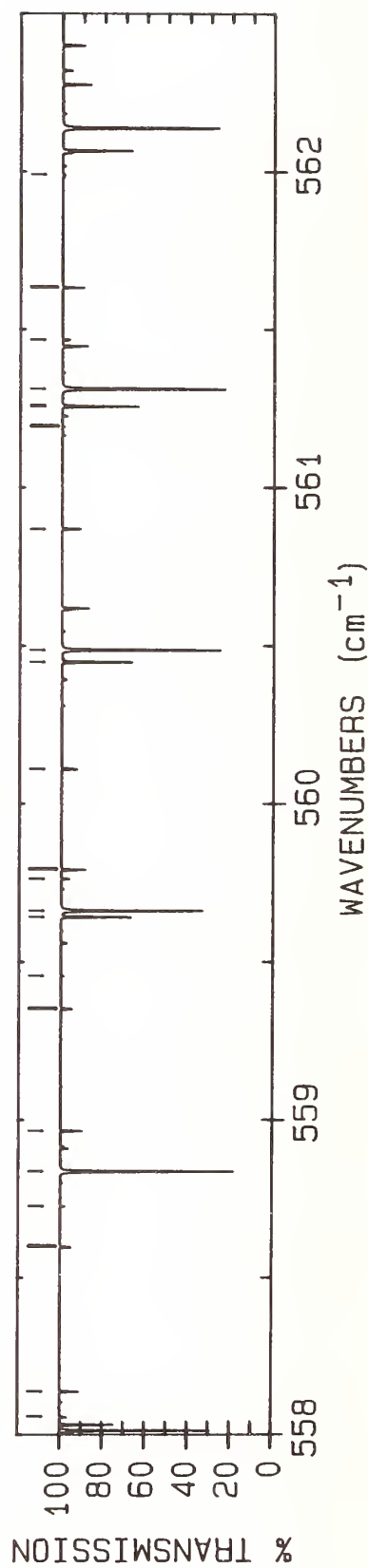
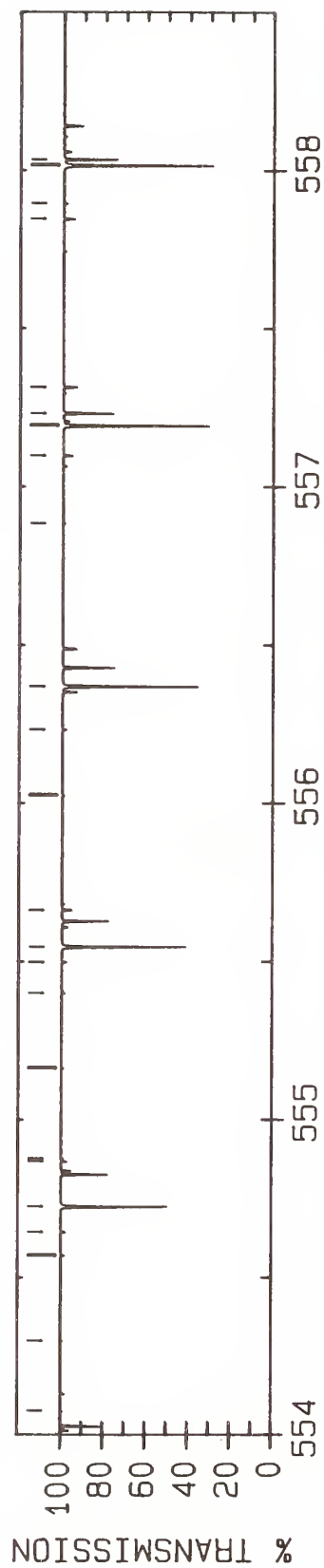
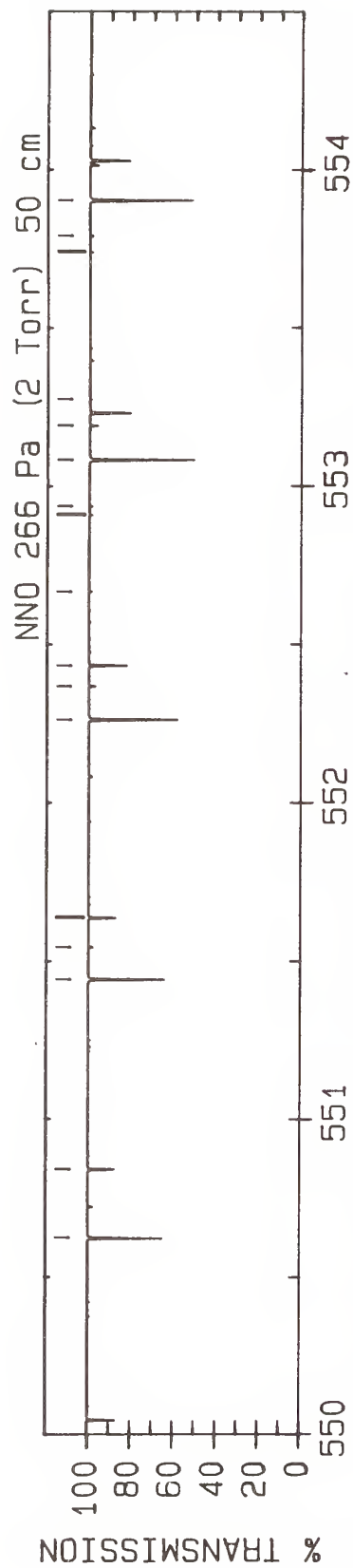

LINE #	WAVENUMBER(unc) (cm ⁻¹)	LOWER STATE (cm ⁻¹)	INTENSITY (cm/molecule)	ASSIGNMENT ROTATION BAND	LINE #	WAVENUMBER(unc) (cm ⁻¹)	LOWER STATE (cm ⁻¹)	INTENSITY (cm/molecule)	ASSIGNMENT ROTATION BAND
1	550.623 26(8)*	905.08	0.434E-21	P(46) A	36	557.230 62(11)*	905.56	0.321E-21	P(27) H
2	550.841 57(11)*	1116.65	0.151E-21	P(35) H	37	557.313 73(8)	1210.77	0.798E-22	P(38) C
3	551.442 70(8)*	866.60	0.514E-21	P(45) A	38	557.846 31(9)	1242.25	0.541E-22	P(39) B
4	551.545 65(10)	1457.34	0.278E-22	P(45) C	39	557.895 71(14)	193.53	0.247E-22	P(21) P
5	551.637 17(11)*	1087.34	0.168E-21	P(34) H	40	558.015 00(8)*	588.78	0.169E-20	P(37) A
6	552.262 61(8)*	828.95	0.606E-21	P(44) A	41	558.033 59(11)*	882.94	0.345E-21	P(26) H
7	552.368 31(10)	1419.61	0.328E-22	P(44) C	42	558.058 14(11)	1485.45	0.344E-22	P(27) G
8	552.433 56(11)*	1058.86	0.187E-21	P(33) H	43	558.139 52(8)	1178.89	0.910E-22	P(37) C
9	552.667 81(9)	1494.20	0.165E-22	P(46) B	44	558.598 03(9)	1209.60	0.628E-22	P(38) B
10	552.910 37(13)	316.65	0.171E-22	P(27) P	45	558.600 70(9)	1278.57	0.153E-22	P(15) I
11	552.937 74(11)	1638.97	0.200E-22	P(33) G	46	558.727 78(14)	175.94	0.257E-22	P(20) P
12	553.082 99(8)*	792.14	0.711E-21	P(43) A	47	558.837 65(11)*	861.16	0.368E-21	P(25) H
13	553.191 43(9)	1382.71	0.385E-22	P(43) C	48	558.838 61(8)*	557.81	0.192E-20	P(36) A
14	553.275 18(9)	1390.28	0.131E-22	P(22) J	49	558.965 75(8)	1147.85	0.103E-21	P(36) C
15	553.740 40(13)	294.04	0.184E-22	P(26) P	50	559.352 62(9)	1177.78	0.725E-22	P(37) B
16	553.791 46(11)	1611.29	0.222E-22	P(32) G	51	559.456 79(9)	1265.97	0.156E-22	P(14) I
17	553.903 83(8)*	756.16	0.832E-21	P(42) A	52	559.642 83(11)*	840.21	0.392E-21	P(24) H
18	554.075 75(9)	1371.80	0.138E-22	P(21) J	53	559.662 67(8)*	527.67	0.217E-20	P(35) A
19	554.300 74(9)	1354.18	0.127E-22	P(20) I	54	559.763 42(11)	1440.98	0.395E-22	P(25) G
20	554.570 78(13)	272.26	0.198E-22	P(25) P	55	559.792 41(8)	1117.64	0.116E-21	P(35) C
21	554.645 09(11)	1584.45	0.244E-22	P(31) G	56	560.110 05(9)	1146.80	0.833E-22	P(36) B
22	554.725 15(8)*	721.01	0.968E-21	P(41) A	57	560.449 15(11)*	820.10	0.414E-21	P(23) H
23	554.868 90(9)	1381.21	0.283E-22	P(43) B	58	560.487 18(8)*	498.37	0.244E-20	P(34) A
24	554.878 14(9)	1354.16	0.144E-22	P(20) J	59	560.870 27(9)	1116.65	0.952E-22	P(35) B
25	555.163 43(9)	1337.38	0.134E-22	P(19) I	60	561.193 25(14)	376.38	0.140E-22	P(30) R
26	555.401 51(13)	251.32	0.211E-22	P(24) P	61	561.256 65(11)*	800.83	0.435E-21	P(22) H
27	555.498 60(11)	1558.45	0.268E-22	P(30) G	62	561.260 50(12)	1677.44	0.997E-23	P(34) F
28	555.546 92(8)*	686.70	0.112E-20	P(40) A	63	561.312 13(8)*	469.91	0.273E-20	P(33) A
29	555.663 47(8)	1277.04	0.605E-22	P(40) C	64	561.467 59(11)	1399.85	0.444E-22	P(23) G
30	556.024 75(9)	1321.41	0.140E-22	P(18) I	65	561.633 25(9)	1087.34	0.108E-21	P(34) B
31	556.232 57(14)	231.22	0.224E-22	P(23) P	66	561.991 02(14)	352.10	0.153E-22	P(29) R
32	556.369 16(8)*	653.23	0.129E-20	P(39) A					
33	556.884 71(9)	1306.29	0.145E-22	P(17) I					
34	557.097 50(9)	1275.74	0.463E-22	P(40) B					
35	557.191 85(8)*	620.59	0.148E-20	P(38) A					

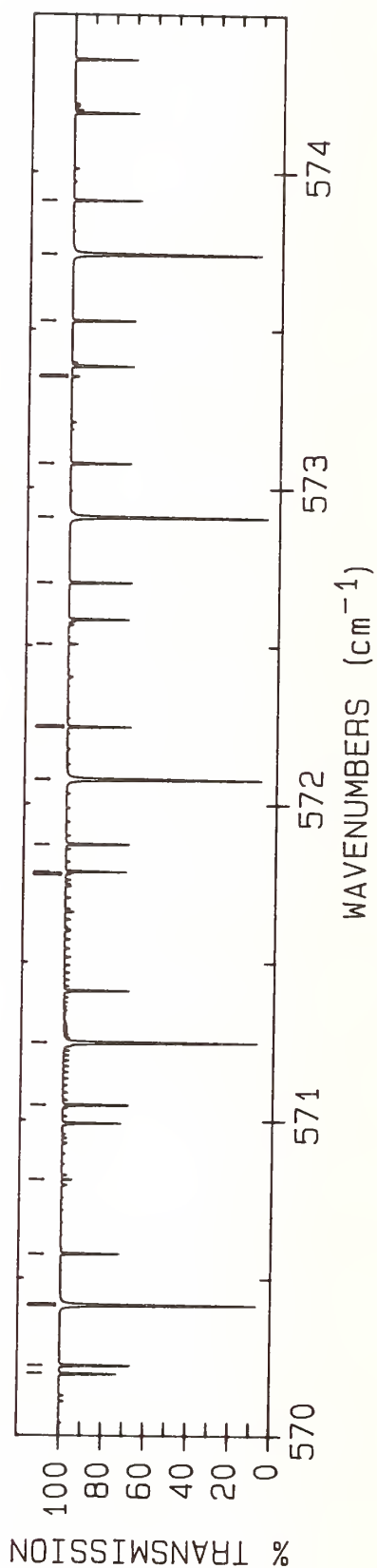
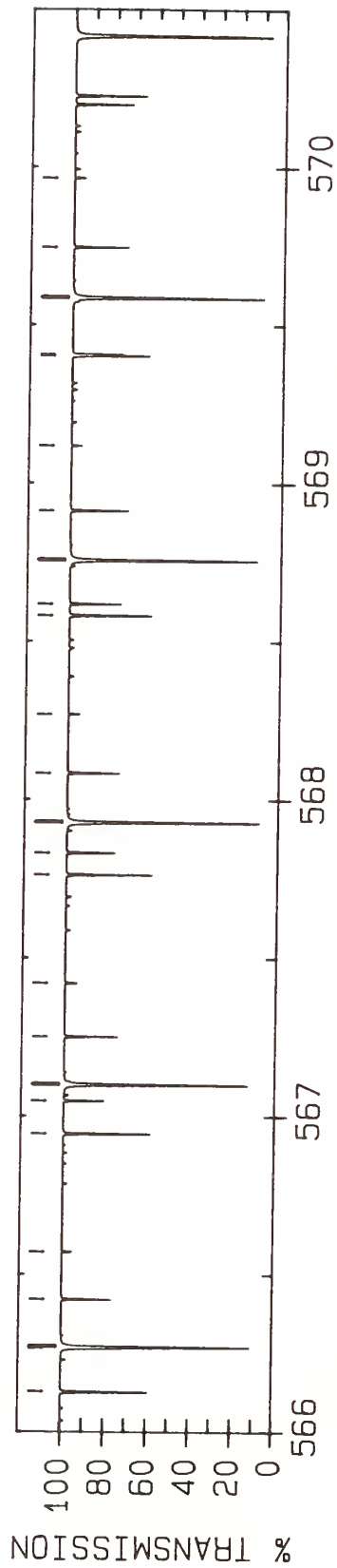
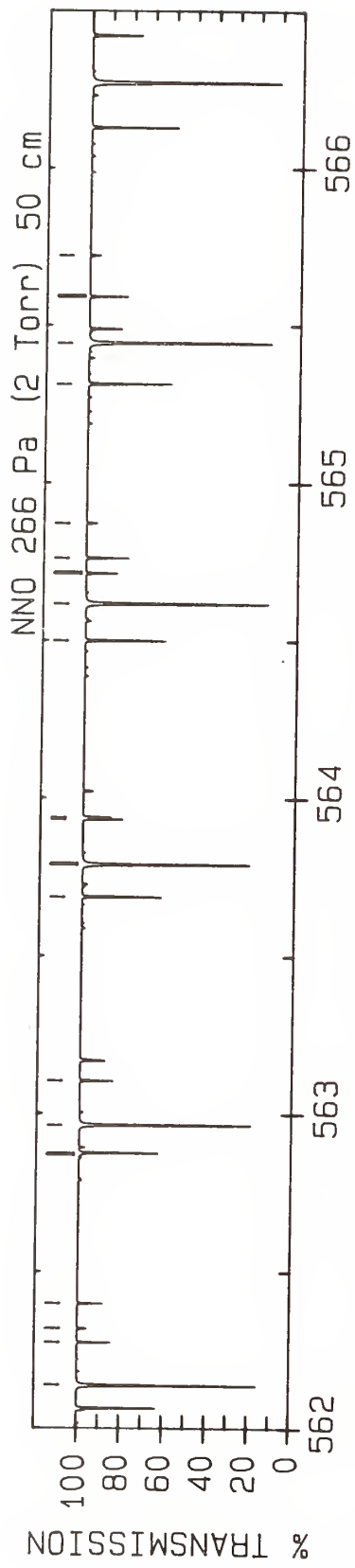

LINE #	WAVENUMBER(cm^{-1})	LOWER STATE (cm^{-1})	INTENSITY ($\text{cm}/\text{molecule}$)	ASSIGNMENT ROTATION BAND	LINE #	WAVENUMBER(cm^{-1})	LOWER STATE (cm^{-1})	INTENSITY ($\text{cm}/\text{molecule}$)	ASSIGNMENT ROTATION BAND
1	562.137 53(8)*	442.28	0.305E-20	P(32) A	36	568.082 38(9)	861.67	0.293E-21	P(25) C
2	562.274 98(8)	1032.06	0.163E-21	P(32) C	37	568.269 48(11)	1268.90	0.543E-22	P(15) G
3	562.319 20(11)	1380.55	0.466E-22	P(22) G	38	568.581 63(11)*	665.05	0.514E-21	P(13) H
4	562.398 95(9)	1058.86	0.122E-21	P(33) B	39	568.617 95(9)	861.16	0.265E-21	P(25) B
5	562.869 02(9)	1223.96	0.153E-22	P(10) I	40	568.756 44(8)*	251.34	0.595E-20	P(24) A
6	562.875 30(11)*	764.79	0.473E-21	P(20) H	41	568.913 65(9)	840.68	0.312E-21	P(24) C
7	562.963 37(8)*	415.49	0.337E-20	P(31) A	42	569.117 70(11)	1256.31	0.538E-22	P(14) G
8	563.103 36(9)	1005.20	0.180E-21	P(31) C	43	569.402 32(11)*	654.15	0.504E-21	P(12) H
9	563.686 51(11)*	748.03	0.488E-21	P(19) H	44	569.406 45(9)	840.21	0.283E-21	P(24) B
10	563.789 66(8)*	389.53	0.372E-20	P(30) A	45	569.585 73(8)*	231.24	0.631E-20	P(23) A
11	563.932 16(9)	979.18	0.198E-21	P(30) C	46	569.745 32(9)	820.54	0.329E-21	P(23) C
12	563.938 36(9)	1004.42	0.154E-21	P(31) B	47	569.965 41(11)	1244.55	0.527E-22	P(13) G
13	564.499 01(11)*	732.11	0.501E-21	P(18) H	48	570.197 31(9)	820.10	0.302E-21	P(23) B
14	564.616 38(8)*	364.41	0.408E-20	P(29) A	49	570.224 43(11)*	644.10	0.489E-21	P(11) H
15	564.711 99(9)	978.45	0.171E-21	P(30) B	50	570.415 43(8)*	211.97	0.665E-20	P(22) A
16	564.761 38(9)	954.01	0.217E-21	P(29) C	51	570.577 39(9)	801.23	0.345E-21	P(22) C
17	564.871 85(11)	1327.67	0.520E-22	P(19) G	52	570.812 59(11)	1233.63	0.511E-22	P(12) G
18	565.312 82(11)*	717.02	0.511E-21	P(17) H	53	571.047 99(11)*	634.88	0.470E-21	P(10) H
19	565.443 53(8)*	340.12	0.445E-20	P(28) A	54	571.245 55(8)*	193.54	0.696E-20	P(21) A
20	565.591 01(9)	929.66	0.236E-21	P(28) C	55	571.778 27(9)	1390.30	0.273E-22	Q(22) I
21	565.721 93(11)	1311.72	0.532E-22	P(18) G	56	571.785 98(9)	782.39	0.335E-21	P(21) B
22	566.127 20(15)	218.31	0.126E-22	P(23) T	57	571.873 00(11)*	626.49	0.446E-21	P(9) H
23	566.127 97(11)*	702.77	0.518E-21	P(16) H	58	572.076 08(8)*	175.95	0.724E-20	P(20) A
24	566.266 92(9)	929.02	0.207E-21	P(28) B	59	572.077 84(9)	1543.16	0.180E-22	Q(29) I
25	566.271 12(8)*	316.67	0.482E-20	P(27) A	60	572.242 71(9)	765.12	0.372E-21	P(20) C
26	566.421 06(9)	906.16	0.255E-21	P(27) C	61	572.505 31(11)	1214.32	0.462E-22	P(10) G
27	566.571 58(11)	1296.61	0.540E-22	P(17) G	62	572.699 47(11)*	618.95	0.418E-21	P(8) H
28	566.944 47(11)*	689.36	0.521E-21	P(15) H	63	572.907 01(8)*	159.20	0.748E-20	P(19) A
29	567.048 15(9)	905.56	0.226E-21	P(27) B	64	573.075 95(9)	748.33	0.382E-21	P(19) C
30	567.099 14(8)*	294.06	0.520E-20	P(26) A	65	573.350 81(11)	1205.92	0.429E-22	P(9) G
31	567.251 52(9)	883.50	0.274E-21	P(26) C	66	573.527 41(11)*	612.24	0.385E-21	P(7) H
32	567.420 76(11)	1282.33	0.544E-22	P(16) G	67	573.738 36(8)*	143.28	0.767E-20	P(18) A
33	567.762 36(11)*	676.79	0.519E-21	P(14) H	68	573.909 58(9)	732.38	0.390E-21	P(18) C
34	567.831 83(9)	882.94	0.245E-21	P(26) B					
35	567.927 58(8)*	272.28	0.558E-20	P(25) A					

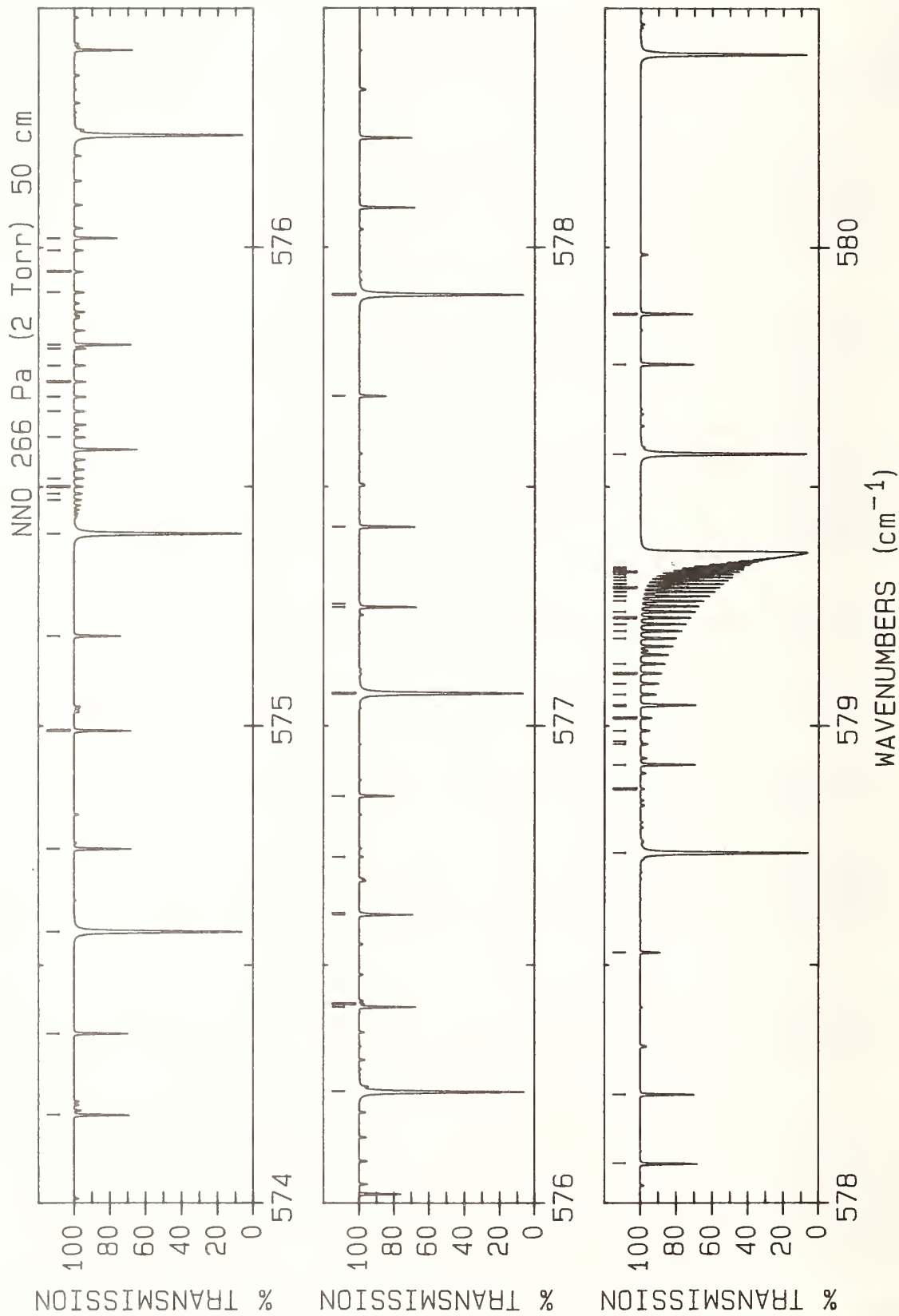

LINE #	WAVENUMBER(unc) (cm ⁻¹)	LOWER STATE (cm ⁻¹)	INTENSITY (cm/molecule)	ASSIGNMENT ROTATION BAND	LINE #	WAVENUMBER(unc) (cm ⁻¹)	LOWER STATE (cm ⁻¹)	INTENSITY (cm/molecule)	ASSIGNMENT ROTATION BAND
1	574.185 88(9)	732.11	0.370E-21	P(18)	36	578.083 38(9)	665.20	0.372E-21	P(13)
2	574.356 83(11)*	606.37	0.348E-21	P(6)	37	578.228 93(9)	665.05	0.362E-21	P(13)
3	574.570 10(8)*	128.20	0.780E-20	P(17)	38	578.526 26(11)*	589.61	0.110E-21	P(1)
4	574.743 59(9)	717.26	0.394E-21	P(17)	39	578.734 72(8)*	65.36	0.747E-20	P(12)
5	574.990 24(9)	717.02	0.376E-21	P(17)	40	578.868 79(12)*	1616.62	0.245E-22	Q(49)
6	575.187 73(11)*	601.34	0.306E-21	P(5)	41	578.919 25(9)	654.28	0.356E-21	P(12)
7	575.402 24(8)*	113.96	0.788E-20	P(16)	42	578.962 08(12)*	1495.90	0.435E-22	Q(46)
8	575.472 86(13)	17.60	0.419E-22	Q(6)	43	578.967 74(9)	1207.99	0.892E-23	R(8)
9	575.485 98(13)	23.46	0.470E-22	Q(7)	44	578.990 13(12)*	1457.34	0.521E-22	Q(45)
10	575.500 96(13)	30.17	0.516E-22	Q(8)	45	579.016 73(12)*	1419.61	0.623E-22	Q(44)
11	575.517 81(13)	37.71	0.555E-22	Q(9)	46	579.041 92(12)*	1382.71	0.740E-22	Q(43)
12	575.603 92(13)	76.25	0.655E-22	Q(13)	47	579.043 81(9)	654.15	0.347E-21	P(12)
13	575.658 18(13)	100.55	0.668E-22	Q(15)	48	579.065 74(11)*	1346.65	0.874E-22	Q(42)
14	575.688 10(13)	113.95	0.666E-22	Q(16)	49	579.088 25(11)*	1311.42	0.103E-21	Q(41)
15	575.719 89(13)	128.19	0.659E-22	Q(17)	50	579.109 47(11)*	1277.04	0.120E-21	Q(40)
16	575.753 54(13)	143.27	0.648E-22	Q(18)	51	579.129 45(11)*	1243.48	0.140E-21	Q(39)
17	575.789 05(13)	159.19	0.632E-22	Q(19)	52	579.182 42(11)*	1147.85	0.214E-21	Q(36)
18	575.796 74(9)	702.77	0.378E-21	P(16)	53	579.197 91(11)*	1117.64	0.245E-21	Q(35)
19	575.906 74(13)	211.96	0.564E-22	Q(22)	54	579.212 37(11)*	1088.28	0.277E-21	Q(34)
20	575.949 67(13)	231.22	0.537E-22	Q(23)	55	579.225 87(11)*	1059.75	0.313E-21	Q(33)
21	575.994 47(13)	251.32	0.507E-22	Q(24)	56	579.238 43(11)*	1032.06	0.352E-21	Q(32)
22	576.020 13(11)*	597.15	0.262E-21	P(4)	57	579.260 95(11)*	979.18	0.436E-21	Q(30)
23	576.234 78(8)*	100.55	0.789E-20	P(15)	58	579.270 98(11)*	954.01	0.481E-21	Q(29)
24	576.412 74(9)	689.55	0.391E-21	P(15)	59	579.280 26(11)*	929.66	0.529E-21	Q(28)
25	576.419 25(15)	442.25	0.266E-22	Q(32)	60	579.288 82(11)*	906.16	0.577E-21	Q(27)
26	576.605 38(9)	689.36	0.377E-21	P(15)	61	579.296 69(11)*	883.50	0.627E-21	Q(26)
27	576.608 86(17)	527.64	0.192E-22	Q(35)	62	579.303 93(11)*	861.67	0.676E-21	Q(25)
28	576.726 85(11)	1180.73	0.246E-22	P(5)	63	579.310 56(11)*	840.68	0.726E-21	Q(24)
29	576.854 01(11)*	593.80	0.214E-21	P(3)	64	579.316 62(11)*	820.54	0.774E-21	Q(23)
30	577.067 71(8)*	87.98	0.782E-20	P(14)	65	579.322 15(11)*	801.23	0.820E-21	Q(22)
31	577.247 88(9)	676.95	0.384E-21	P(14)	66	579.327 19(11)*	782.76	0.863E-21	Q(21)
32	577.255 30(9)	1195.39	0.643E-23	R(6)	67	579.331 76(11)*	765.12	0.904E-21	Q(20)
33	577.416 12(9)	676.79	0.372E-21	P(14)	68	579.568 80(8)*	55.31	0.716E-20	P(11)
34	577.689 39(11)*	591.28	0.163E-21	P(2)	69	579.755 48(9)	644.20	0.335E-21	P(11)
35	577.901 02(8)*	76.25	0.769E-20	P(13)	70	579.860 72(9)	644.10	0.329E-21	P(11)

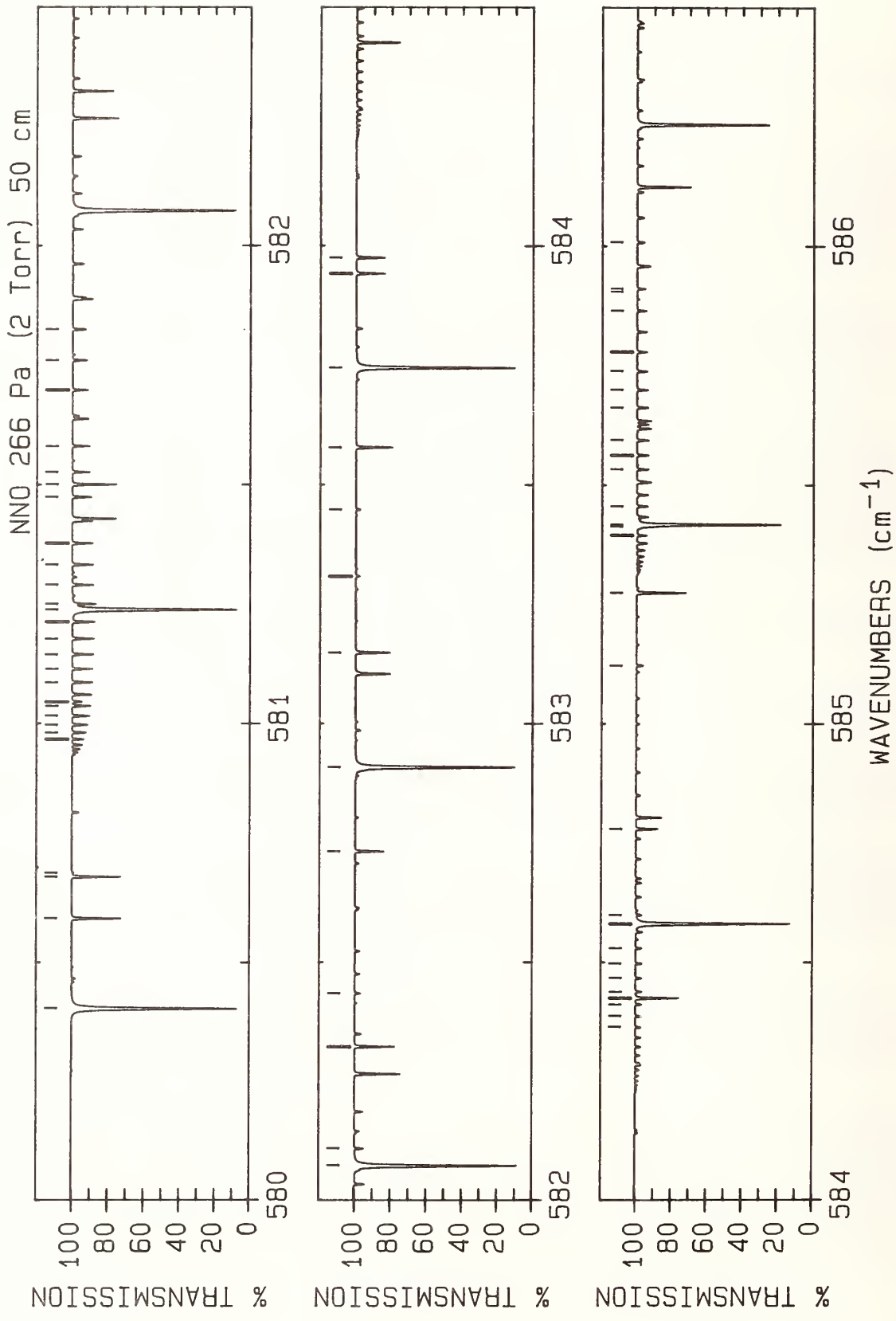

LINE #	WAVENUMBER(unc) (cm ⁻¹)	LOWER STATE (cm ⁻¹)	INTENSITY (cm/molecule)	ASSIGNMENT ROTATION BAND	LINE #	WAVENUMBER(unc) (cm ⁻¹)	LOWER STATE (cm ⁻¹)	INTENSITY (cm/molecule)	ASSIGNMENT ROTATION BAND
1	580.403 26(8)*	46.09	0.678E-20	P(10) A	36	583.308 58(7)	1201.27	0.119E-22	P(7) F
2	580.592 06(9)	634.96	0.310E-21	P(10) C	37	583.448 09(11)	1170.65	0.268E-22	R(2) G
3	580.679 65(9)	634.88	0.305E-21	P(10) B	38	583.578 50(11)*	597.15	0.220E-21	R(4) H
4	580.687 48(9)	1223.96	0.110E-22	R(10) J	39	583.744 80(8)*	17.60	0.441E-20	P(6) A
5	580.967 42(11)	1180.73	0.690E-22	Q(5) G	40	583.941 90(9)	606.41	0.168E-21	P(6) C
6	580.981 35(11)	1185.77	0.795E-22	Q(6) G	41	583.975 21(9)	606.37	0.167E-21	P(6) B
7	580.997 62(11)	1191.65	0.890E-22	Q(7) G	42	584.364 03(14)	61.71	0.343E-22	Q(12) T
8	581.016 23(11)	1198.37	0.975E-22	Q(8) G	43	584.387 23(14)	71.99	0.353E-22	Q(13) T
9	581.037 17(11)	1205.92	0.105E-21	Q(9) G	44	584.412 22(14)	83.06	0.359E-22	Q(14) T
10	581.045 77(11)*	589.61	0.560E-22	R(1) H	45	584.425 64(11)*	601.34	0.272E-21	R(5) H
11	581.086 13(11)	1223.56	0.116E-21	Q(11) G	46	584.438 98(14)	94.93	0.362E-22	Q(15) T
12	581.114 15(11)	1233.63	0.120E-21	Q(12) G	47	584.467 53(14)	107.58	0.363E-22	Q(16) T
13	581.144 54(11)	1244.55	0.123E-21	Q(13) G	48	584.497 85(14)	121.03	0.361E-22	Q(17) T
14	581.177 32(11)	1256.31	0.124E-21	Q(14) G	49	584.529 95(14)	135.27	0.356E-22	Q(18) T
15	581.212 48(11)	1268.90	0.125E-21	Q(15) G	50	584.581 09(8)*	12.57	0.363E-20	P(5) A
16	581.238 10(8)*	37.71	0.630E-20	P(9) A	51	584.599 47(14)	166.12	0.339E-22	Q(20) T
17	581.250 05(11)	1282.33	0.124E-21	Q(16) G	52	584.780 21(9)	601.37	0.125E-21	P(5) C
18	581.290 02(11)	1296.61	0.122E-21	Q(17) G	53	585.121 66(11)	1176.53	0.395E-22	R(4) G
19	581.332 42(11)	1311.72	0.120E-21	Q(18) G	54	585.274 19(11)*	606.37	0.320E-21	R(6) H
20	581.377 24(11)	1327.67	0.116E-21	Q(19) G	55	585.395 05(13)	36.44	0.554E-22	Q(9) R
21	581.474 24(11)	1362.08	0.108E-21	Q(21) G	56	585.413 51(13)	44.53	0.589E-22	Q(10) R
22	581.500 58(9)	626.49	0.277E-21	P(9) B	57	585.417 73(8)*	8.38	0.279E-20	P(4) A
23	581.526 44(11)	1380.55	0.103E-21	Q(22) G	58	585.455 96(13)	63.15	0.640E-22	Q(12) R
24	581.581 11(11)	1399.85	0.975E-22	Q(23) G	59	585.533 44(13)	97.16	0.673E-22	Q(15) R
25	581.697 95(11)	1440.98	0.860E-22	Q(25) G	60	585.562 95(13)	110.11	0.673E-22	Q(16) R
26	581.760 15(11)	1462.80	0.800E-22	Q(26) G	61	585.594 29(14)	123.87	0.668E-22	Q(17) R
27	581.824 87(11)	1485.45	0.741E-22	Q(27) G	62	585.662 49(14)	153.82	0.643E-22	Q(19) R
28	582.073 30(8)*	30.17	0.575E-20	P(8) A	63	585.699 33(14)	170.01	0.625E-22	Q(20) R
29	582.109 35(11)	1584.45	0.515E-22	Q(31) G	64	585.738 01(14)	187.01	0.604E-22	Q(21) R
30	582.323 49(9)	618.95	0.244E-21	P(8) B	65	585.778 52(14)	204.82	0.580E-22	Q(22) R
31	582.435 33(11)	1696.84	0.329E-22	Q(35) G	66	585.865 03(14)	242.85	0.524E-22	Q(24) R
32	582.732 80(11)*	593.80	0.167E-21	R(3) H	67	585.904 96(27)	747.87	0.427E-23	Q(43) T
33	582.908 87(8)*	23.46	0.512E-20	P(7) A	68	585.911 03(13)	263.09	0.495E-22	Q(25) R
34	583.148 37(9)	612.24	0.207E-21	P(7) B	69	586.008 48(13)	305.98	0.433E-22	Q(27) R
35	583.308 40(7)	1201.27	0.119E-22	P(7) E					

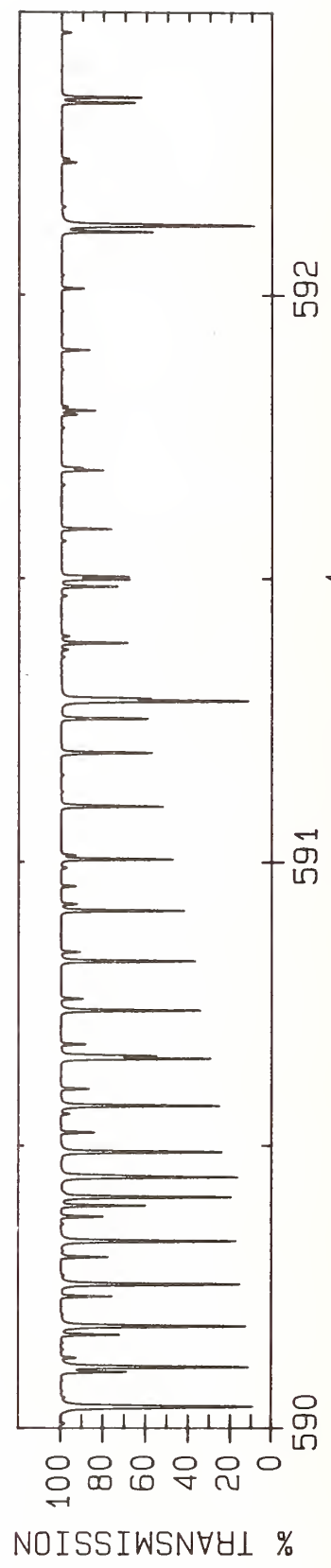
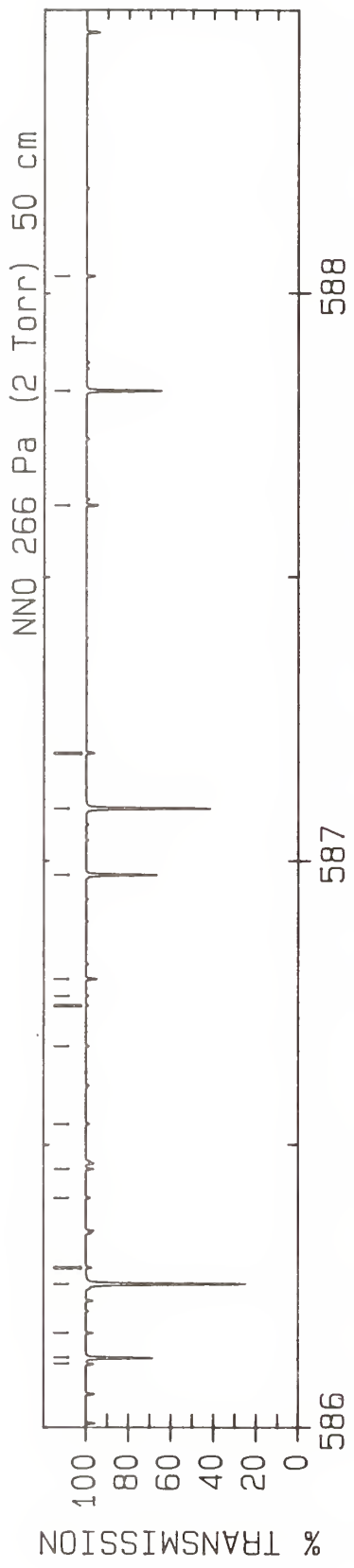

LINE #	WAVENUMBER(unc) (cm ⁻¹)	LOWER STATE (cm ⁻¹)	INTENSITY (cm/molecule)	ASSIGNMENT ROTATION BAND	LINE #	WAVENUMBER(unc) (cm ⁻¹)	LOWER STATE (cm ⁻¹)	INTENSITY (cm/molecule)	ASSIGNMENT ROTATION BAND
1	586.113 22(14)	352.10	0.372E-22	Q(29) R	36	589.070 32(9)	801.23	0.975E-21	Q(22) C
2	586.124 16(11)*	612.24	0.366E-21	R(7) H	37	589.090 85(9)	840.68	0.889E-21	Q(24) C
3	586.168 31(14)	376.38	0.341E-22	Q(30) R	38	589.095 35(8)*	143.28	0.183E-19	Q(18) A
4	586.254 73(8)*	5.03	0.190E-20	P(3) A	39	589.101 81(9)	644.10	0.981E-21	Q(11) B
5	586.283 94(14)	427.35	0.284E-22	Q(32) R	40	589.102 17(9)	861.67	0.841E-21	Q(25) C
6	586.406 81(15)	481.55	0.232E-22	Q(34) R	41	589.127 04(9)	906.16	0.742E-21	Q(27) C
7	586.457 83(9)	593.81	0.363E-22	P(3) C	42	589.131 70(8)*	159.20	0.178E-19	Q(19) A
8	586.536 90(17)	538.98	0.185E-22	Q(36) R	43	589.169 95(8)*	175.95	0.173E-19	Q(20) A
9	586.674 18(19)	599.64	0.146E-22	Q(38) R	44	589.170 44(9)	979.18	0.591E-21	Q(30) C
10	586.745 52(20)	631.18	0.128E-22	Q(39) R	45	589.250 83(6)	1243.28	0.855E-22	Q(12) E
11	586.762 47(9)	1306.29	0.146E-22	R(17) J	46	589.252 16(8)*	211.97	0.159E-19	Q(22) A
12	586.792 49(11)	1185.77	0.509E-22	R(6) G	47	589.252 26(6)	1243.28	0.855E-22	Q(12) F
13	586.975 52(11)*	618.95	0.408E-21	R(8) H	48	589.295 00(6)	1278.57	0.909E-22	Q(15) E
14	587.092 07(8)*	2.51	0.968E-21	P(2) A	49	589.296 11(8)*	231.24	0.151E-19	Q(23) A
15	587.189 59(13)	76.25	0.389E-22	R(13) P	50	589.298 39(6)	1278.56	0.909E-22	Q(15) F
16	587.626 86(11)	1191.65	0.559E-22	R(7) G	51	589.300 64(9)	732.11	0.104E-20	Q(18) B
17	587.828 24(11)*	626.49	0.446E-21	R(9) H	52	589.336 58(9)	748.03	0.101E-20	Q(19) B
18	588.030 88(13)	87.98	0.394E-22	R(14) P	53	589.341 96(8)*	251.34	0.143E-19	Q(24) A
19	588.460 56(11)	1198.37	0.605E-22	R(8) G	54	589.347 91(6)	1321.41	0.892E-22	Q(18) E
20	588.682 32(11)*	634.88	0.480E-21	R(10) H	55	589.387 83(6)	1354.18	0.848E-22	Q(20) E
21	588.796 54(8)*	12.57	0.102E-19	Q(5) A	56	589.389 71(8)*	272.28	0.134E-19	Q(25) A
22	588.808 04(8)*	17.60	0.118E-19	Q(6) A	57	589.391 58(9)	1354.16	0.142E-22	R(20) J
23	588.821 46(8)*	23.46	0.132E-19	Q(7) A	58	589.439 34(8)*	294.06	0.126E-19	Q(26) A
24	588.836 80(8)*	30.17	0.145E-19	Q(8) A	59	589.490 87(8)*	316.67	0.117E-19	Q(27) A
25	588.854 05(8)*	37.71	0.156E-19	Q(9) A	60	589.537 73(11)*	644.10	0.509E-21	R(11) H
26	588.873 22(8)*	46.09	0.166E-19	Q(10) A	61	589.544 28(8)*	340.12	0.108E-19	Q(28) A
27	588.894 30(8)*	55.31	0.174E-19	Q(11) A	62	589.544 51(9)	840.21	0.816E-21	Q(24) B
28	588.917 29(8)*	65.36	0.180E-19	Q(12) A	63	589.599 58(8)*	364.41	0.995E-20	Q(29) A
29	588.942 19(8)*	76.25	0.184E-19	Q(13) A	64	589.656 77(8)*	389.53	0.910E-20	Q(30) A
30	588.969 01(8)*	87.98	0.187E-19	Q(14) A	65	589.715 83(8)*	415.49	0.828E-20	Q(31) A
31	589.036 82(9)	732.38	0.109E-20	Q(18) C	66	589.744 58(9)	929.02	0.617E-21	Q(28) B
32	589.052 38(9)	765.12	0.104E-20	Q(20) C	67	589.776 78(8)*	442.28	0.751E-20	Q(32) A
33	589.060 90(8)*	128.20	0.186E-19	Q(17) A	68	589.839 60(8)*	469.91	0.676E-20	Q(33) A
34	589.061 04(9)	782.76	0.101E-20	Q(21) C	69	589.855 82(8)	978.45	0.519E-21	Q(30) B
35	589.062 02(9)	626.49	0.876E-21	Q(9) B	70	589.904 30(8)*	498.37	0.607E-20	Q(34) A

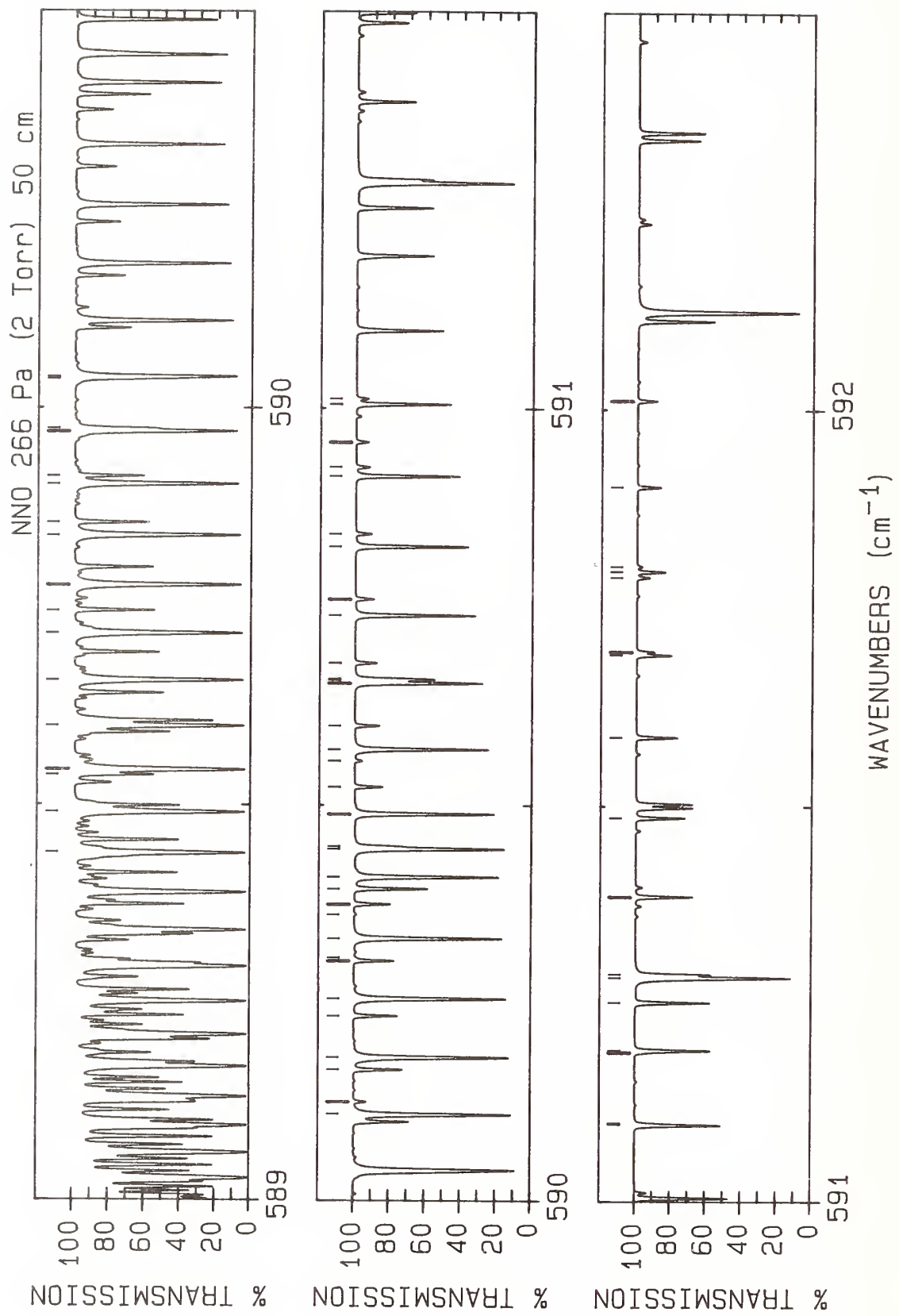

LINE #	WAVENUMBER(linc) (cm ⁻¹)	LOWER STATE (cm ⁻¹)	INTENSITY (cm/molecule)	ASSIGNMENT ROTATION BAND	LINE #	WAVENUMBER(unc) (cm ⁻¹)	LOWER STATE (cm ⁻¹)	INTENSITY (cm/molecule)	ASSIGNMENT ROTATION BAND
1	589.439 34(8)*	294.06	0.126E-19	Q(26) A	36	590.523 28(8)	1275.74	0.163E-21	Q(40) B
2	589.490 87(8)*	316.67	0.117E-19	Q(27) A	37	590.555 84(14)	128.19	0.390E-22	R(17) P
3	589.537 73(11)*	644.10	0.509E-21	R(11) H	38	590.570 44(8)*	792.14	0.184E-20	Q(43) A
4	589.544 28(8)*	340.12	0.108E-19	Q(28) A	39	590.600 16(9)	1310.06	0.141E-21	Q(41) B
5	589.544 51(9)	840.21	0.816E-21	Q(24) B	40	590.653 72(8)*	828.95	0.157E-20	Q(44) A
6	589.599 58(8)*	364.41	0.995E-20	Q(29) A	41	590.657 50(9)	589.61	0.342E-21	R(1) C
7	589.656 77(8)*	389.53	0.910E-20	Q(30) A	42	590.659 09(9)	589.61	0.342E-21	R(1) B
8	589.715 83(8)*	415.49	0.828E-20	Q(31) A	43	590.678 88(9)	1345.22	0.122E-21	Q(42) B
9	589.744 58(9)	929.02	0.617E-21	Q(28) B	44	590.738 84(8)*	866.60	0.134E-20	Q(45) A
10	589.776 78(8)*	442.28	0.751E-20	Q(32) A	45	590.759 42(9)	1381.21	0.105E-21	Q(43) B
11	589.839 60(8)*	469.91	0.676E-20	Q(33) A	46	590.825 80(9)*	905.08	0.113E-20	Q(46) A
12	589.855 82(8)	978.45	0.519E-21	Q(30) B	47	590.841 78(10)	1418.04	0.898E-22	Q(44) B
13	589.904 30(8)*	498.37	0.607E-20	Q(34) A	48	590.914 59(9)*	944.39	0.958E-21	Q(47) A
14	589.914 23(8)	1004.42	0.473E-21	Q(31) B	49	590.925 97(10)	1455.70	0.764E-22	Q(45) B
15	589.970 86(8)*	527.67	0.542E-20	Q(35) A	50	590.957 53(11)	1223.56	0.709E-22	R(11) G
16	589.974 50(8)	1031.22	0.429E-21	Q(32) B	51	591.005 21(9)*	984.54	0.805E-21	Q(48) A
17	590.036 63(8)	1058.86	0.386E-21	Q(33) B	52	591.011 98(11)	1494.20	0.648E-22	Q(46) B
18	590.039 30(8)*	557.81	0.481E-20	Q(36) A	53	591.097 66(9)*	1025.52	0.673E-21	Q(49) A
19	590.109 60(8)*	588.78	0.425E-20	Q(37) A	54	591.099 80(12)	1533.53	0.547E-22	Q(47) B
20	590.125 89(11)	1214.32	0.680E-22	R(10) G	55	591.189 42(14)	1573.69	0.459E-22	Q(48) B
21	590.166 44(8)	1116.65	0.309E-21	Q(35) B	56	591.191 94(9)*	1067.33	0.561E-21	Q(50) A
22	590.181 77(8)*	620.59	0.374E-20	Q(38) A	57	591.252 43(11)*	665.05	0.554E-21	R(13) H
23	590.234 12(8)	1146.80	0.275E-21	Q(36) B	58	591.283 82(8)*	2.51	0.397E-20	R(2) A
24	590.255 79(8)*	653.23	0.328E-20	Q(39) A	59	591.288 03(10)*	1109.98	0.465E-21	Q(51) A
25	590.303 65(8)	1177.78	0.243E-21	Q(37) B	60	591.385 94(10)*	1153.46	0.384E-21	Q(52) A
26	590.307 43(96)	2008.88	0.814E-23	Q(44) F	61	591.485 66(10)*	1197.77	0.315E-21	Q(53) A
27	590.331 68(8)*	686.70	0.285E-20	Q(40) A	62	591.587 18(10)*	1242.91	0.258E-21	Q(54) A
28	590.361 80(9)*	1302.43	0.863E-23	P(6) D	63	591.690 51(11)*	1288.88	0.210E-21	Q(55) A
29	590.362 1	2046.63	0.694E-23	Q(45) F	64	591.694 56(7)	1180.27	0.487E-22	R(2) E
30	590.375 02(8)	1209.60	0.214E-21	Q(38) B	65	591.694 56(7)	1180.27	0.487E-22	R(2) F
31	590.394 44(11)*	654.15	0.534E-21	R(12) H	66	591.788 50(11)	1233.63	0.732E-22	R(12) G
32	590.409 41(8)*	721.01	0.248E-20	Q(41) A	67	591.795 64(11)*	1335.69	0.170E-21	Q(56) A
33	590.444 81(8)*	0.84	0.298E-20	R(1) A	68	591.802 29(13)	22.67	0.292E-22	R(7) R
34	590.448 23(8)	1242.25	0.187E-21	Q(39) B	69	591.902 57(11)*	1383.33	0.138E-21	Q(57) A
35	590.489 00(8)*	756.16	0.214E-20	Q(42) A	70	592.011 28(12)*	1431.79	0.111E-21	Q(58) A

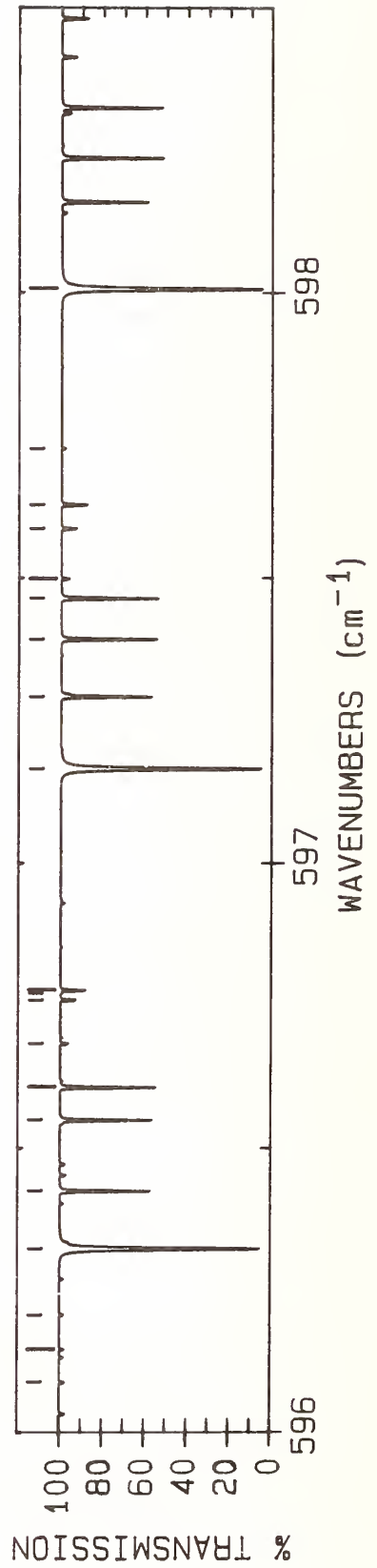
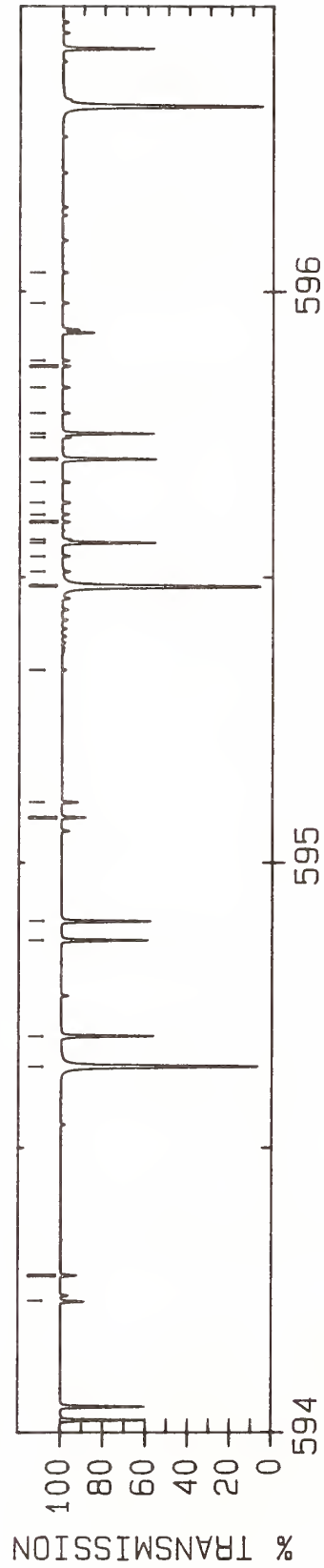
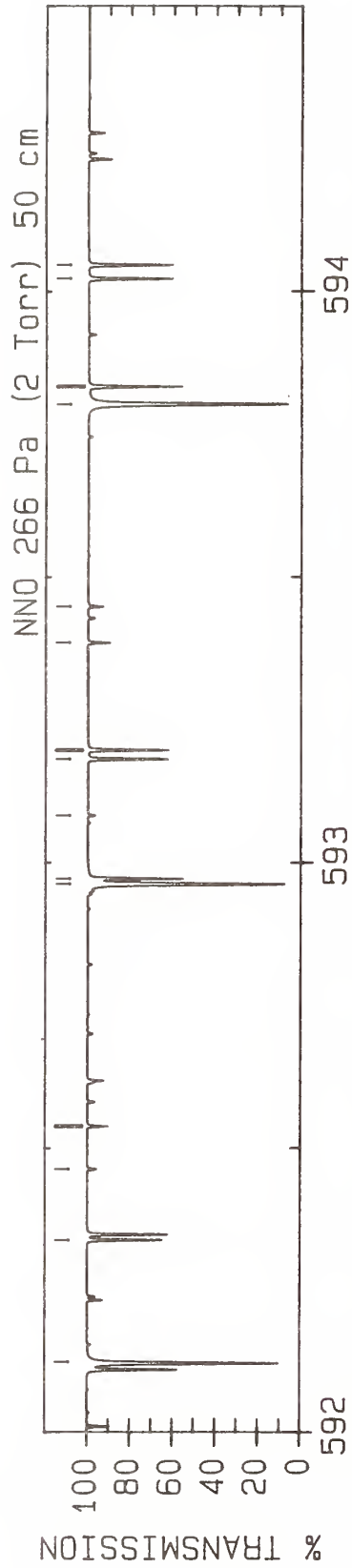

LINE #	WAVENUMBER(unc) (cm ⁻¹)	LOWER STATE (cm ⁻¹)	INTENSITY (cm/molecule)	ASSIGNMENT ROTATION BAND	LINE #	WAVENUMBER(unc) (cm ⁻¹)	LOWER STATE (cm ⁻¹)	INTENSITY (cm/molecule)	ASSIGNMENT ROTATION BAND
1	592.123 16(8)*	5.03	0.492E-20	R(3) A	36	595.610 18(13)	231.22	0.320E-22	R(23) P
2	592.339 53(9)	593.81	0.423E-21	R(3) C	37	595.630 77(9)*	1385.04	0.369E-22	Q(15) D
3	592.463 96(13)*	1633.97	0.443E-22	Q(62) A	38	595.666 55(9)*	1398.38	0.368E-22	Q(16) D
4	592.539 12(7)	1182.79	0.508E-22	R(3) E	39	595.704 57(9)*	1412.57	0.364E-22	Q(17) D
5	592.539 12(7)	1182.79	0.508E-22	R(3) F	40	595.707 09(9)	612.29	0.591E-21	R(7) C
6	592.962 80(8)*	8.38	0.584E-20	R(4) A	41	595.744 83(9)*	1427.58	0.358E-22	Q(18) D
7	592.972 14(11)*	689.36	0.579E-21	R(15) H	42	595.751 74(9)	612.24	0.586E-21	R(7) B
8	593.082 32(14)	175.94	0.364E-22	R(20) P	43	595.787 33(9)*	1443.43	0.350E-22	Q(19) D
9	593.180 99(9)	597.17	0.468E-21	R(4) C	44	595.832 07(9)*	1460.12	0.339E-22	Q(20) D
10	593.196 88(9)	597.15	0.467E-21	R(4) B	45	595.869 50(13)	63.15	0.381E-22	R(12) R
11	593.384 73(7)	1186.15	0.535E-22	R(4) E	46	595.879 05(9)*	1477.64	0.326E-22	Q(21) D
12	593.384 76(7)	1186.15	0.535E-22	R(4) F	47	595.979 73(9)*	1515.18	0.297E-22	Q(23) D
13	593.448 43(11)	1256.31	0.759E-22	R(14) G	48	596.033 43(9)*	1535.19	0.281E-22	Q(24) D
14	593.802 76(8)*	12.57	0.671E-20	R(5) A	49	596.089 37(9)*	1556.05	0.264E-22	Q(25) D
15	593.833 80(11)*	702.77	0.584E-21	R(16) H	50	596.147 55(9)*	1577.73	0.247E-22	Q(26) D
16	594.022 74(9)	601.37	0.512E-21	R(5) C	51	596.207 98(9)*	1600.25	0.230E-22	Q(27) D
17	594.046 60(9)	601.34	0.509E-21	R(5) B	52	596.324 46(8)*	30.17	0.892E-20	R(8) A
18	594.231 41(7)	1190.35	0.564E-22	R(5) E	53	596.425 63(11)*	748.03	0.575E-21	R(19) H
19	594.231 46(7)	1190.35	0.564E-22	R(5) F	54	596.549 68(9)	619.00	0.624E-21	R(8) C
20	594.277 41(11)	1268.90	0.764E-22	R(15) G	55	596.607 17(9)	618.95	0.617E-21	R(8) B
21	594.643 03(8)*	17.60	0.751E-20	R(6) A	56	596.683 88(13)	73.68	0.390E-22	R(13) R
22	594.696 63(11)*	717.02	0.586E-21	R(17) H	57	596.760 47(11)	1311.72	0.746E-22	R(18) G
23	594.864 77(9)	606.41	0.553E-21	R(6) C	58	596.772 20(9)*	1810.37	0.107E-22	Q(35) D
24	594.898 22(9)	606.37	0.550E-21	R(6) B	59	596.777 65(6)	1207.99	0.641E-22	R(8) E
25	595.079 12(6)	1195.39	0.593E-22	R(6) E	60	596.777 96(6)	1207.99	0.641E-22	R(8) F
26	595.079 22(6)	1195.39	0.593E-22	R(6) F	61	597.165 63(8)*	37.71	0.951E-20	R(9) A
27	595.105 73(11)	1282.33	0.763E-22	R(16) G	62	597.291 75(11)*	764.79	0.564E-21	R(20) H
28	595.337 18(14)	71.99	0.209E-22	R(13) T	63	597.392 54(9)	626.56	0.653E-21	R(9) C
29	595.483 60(8)*	23.46	0.826E-20	R(7) A	64	597.464 53(9)	626.49	0.644E-21	R(9) B
30	595.485 41(9)*	1330.80	0.325E-22	Q(10) D	65	597.498 55(14)	85.01	0.396E-22	R(14) R
31	595.510 00(9)*	1339.98	0.341E-22	Q(11) D	66	597.586 91(11)	1327.67	0.730E-22	R(19) G
32	595.536 84(9)*	1349.99	0.353E-22	Q(12) D	67	597.628 44(6)	1215.56	0.660E-22	R(9) E
33	595.560 58(11)*	732.11	0.582E-21	R(18) H	68	597.628 92(6)	1215.55	0.660E-22	R(9) F
34	595.565 91(9)*	1360.84	0.361E-22	Q(13) D	69	597.726 60(14)	107.58	0.214E-22	R(16) T
35	595.597 22(9)*	1372.52	0.367E-22	Q(14) D	70	598.007 07(8)*	46.09	0.100E-19	R(10) A

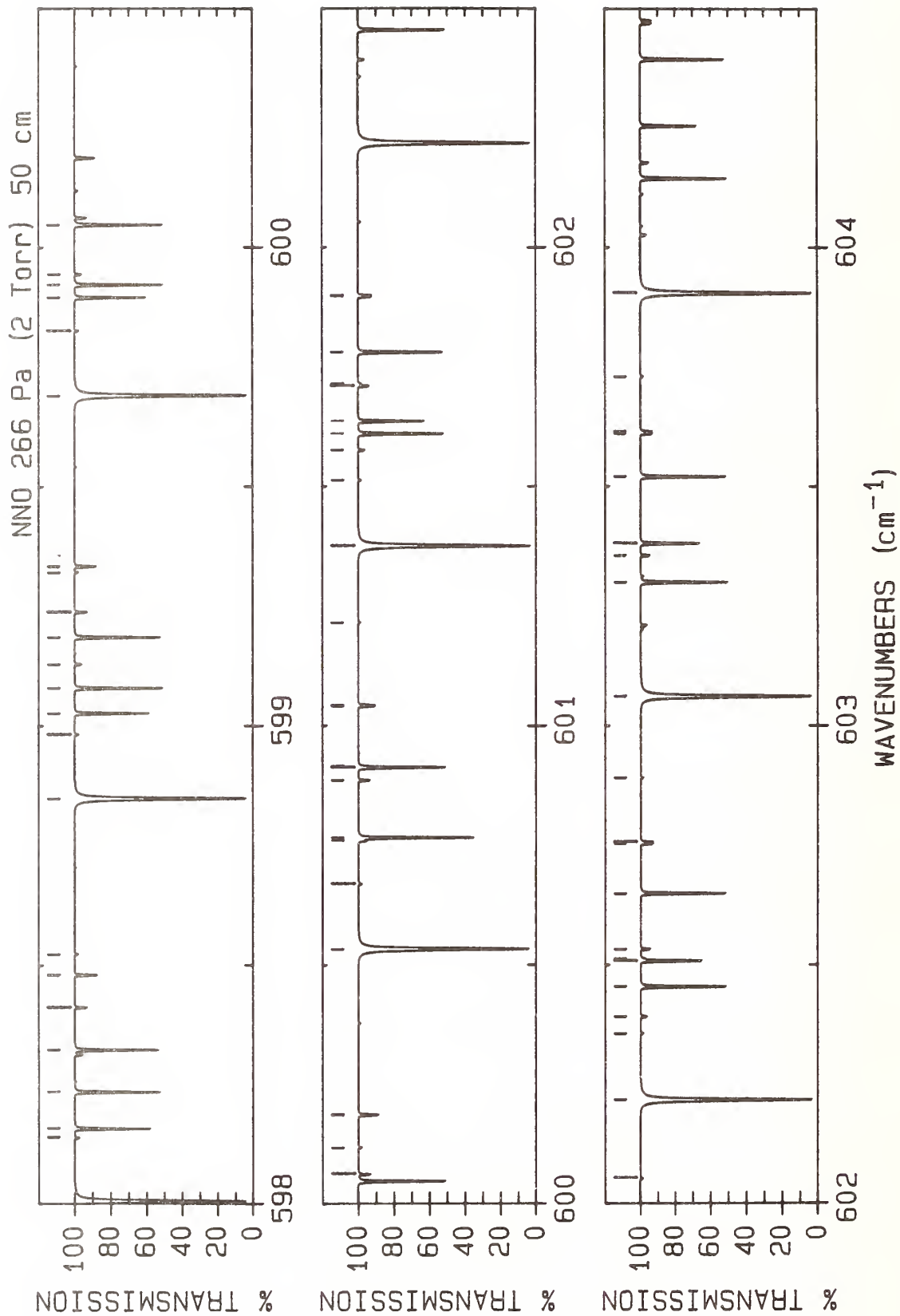

LINE #	WAVENUMBER(unc) (cm ⁻¹)	LOWER STATE (cm ⁻¹)	INTENSITY (cm/molecule)	ASSIGNMENT ROTATION BAND	LINE #	WAVENUMBER(unc) (cm ⁻¹)	LOWER STATE (cm ⁻¹)	INTENSITY (cm/molecule)	ASSIGNMENT ROTATION BAND	LINE #	WAVENUMBER(unc) (cm ⁻¹)	LOWER STATE (cm ⁻¹)	INTENSITY (cm/molecule)	ASSIGNMENT ROTATION BAND
1	598.139 28(13)	294.04	0.268E-22	R(26) P	36	600.916 55(15)	166.12	0.201E-22	R(20) T					
2	598.158 88(11)*	782.39	0.550E-21	R(21) H	37	601.041 47(6)	1254.20	0.692E-22	R(13) E					
3	598.235 67(9)	634.96	0.677E-21	R(10) C	38	601.043 44(6)	1254.20	0.692E-22	R(13) F					
4	598.323 81(9)	634.88	0.665E-21	R(10) B	39	601.215 49(9)*	1302.43	0.147E-22	R(6) D					
5	598.412 73(11)	1344.45	0.710E-22	R(20) G	40	601.375 66(8)*	87.98	0.111E-19	R(14) A					
6	598.480 23(6)	1223.96	0.675E-22	R(10) E	41	601.513 07(14)	389.50	0.196E-22	R(30) P					
7	598.480 95(6)	1223.96	0.675E-22	R(10) F	42	601.576 26(14)	153.82	0.381E-22	R(19) R					
8	598.523 66(15)	121.03	0.213E-22	R(17) T	43	601.610 75(9)	676.95	0.719E-21	R(14) C					
9	598.848 81(8)*	55.31	0.104E-19	R(11) A	44	601.636 90(11)*	861.16	0.468E-21	R(25) H					
10	598.982 56(13)	316.65	0.250E-22	R(27) P	45	601.710 16(11)	1420.00	0.600E-22	R(24) G					
11	599.027 01(11)*	800.83	0.533E-21	R(22) H	46	601.714 74(15)	182.72	0.195E-22	R(21) T					
12	599.079 06(9)	644.20	0.695E-21	R(11) C	47	601.780 45(9)	676.79	0.696E-21	R(14) B					
13	599.128 78(14)	110.11	0.398E-22	R(16) R	48	601.897 11(6)	1265.97	0.689E-22	R(14) E					
14	599.185 03(9)	644.10	0.681E-21	R(11) B	49	601.899 75(6)	1265.96	0.689E-22	R(14) F					
15	599.237 95(11)	1362.08	0.687E-22	R(21) G	50	602.053 23(9)*	1308.27	0.162E-22	R(7) D					
16	599.321 01(15)	135.27	0.210E-22	R(18) T	51	602.218 48(8)*	100.55	0.111E-19	R(15) A					
17	599.333 01(6)	1233.20	0.685E-22	R(11) E	52	602.356 77(15)	415.46	0.179E-22	R(31) P					
18	599.334 05(6)	1233.20	0.685E-22	R(11) F	53	602.392 63(14)	170.01	0.370E-22	R(20) R					
19	599.690 82(8)*	65.36	0.107E-19	R(12) A	54	602.455 14(9)	689.55	0.717E-21	R(15) C					
20	599.825 96(14)	340.10	0.232E-22	R(28) P	55	602.508 56(11)*	882.94	0.443E-21	R(26) H					
21	599.896 08(11)*	820.10	0.513E-21	R(23) H	56	602.513 19(15)	200.12	0.187E-22	R(22) T					
22	599.922 71(9)	654.28	0.709E-21	R(12) C	57	602.533 11(11)	1440.98	0.567E-22	R(25) G					
23	599.944 33(14)	123.87	0.395E-22	R(17) R	58	602.649 55(9)	689.36	0.690E-21	R(15) B					
24	600.048 20(9)	654.15	0.692E-21	R(12) B	59	602.753 68(6)	1278.57	0.682E-22	R(15) E					
25	600.062 59(11)	1380.55	0.660E-22	R(22) G	60	602.757 13(6)	1278.56	0.681E-22	R(15) F					
26	600.118 65(15)	150.30	0.206E-22	R(19) T	61	602.891 36(9)*	1314.94	0.175E-22	R(8) D					
27	600.186 76(6)	1243.28	0.691E-22	R(12) E	62	603.061 56(8)*	113.96	0.111E-19	R(16) A					
28	600.188 21(6)	1243.28	0.691E-22	R(12) F	63	603.299 77(9)	702.99	0.710E-21	R(16) C					
29	600.533 11(8)*	76.25	0.110E-19	R(13) A	64	603.355 54(11)	1462.80	0.533E-22	R(26) G					
30	600.669 46(14)	364.38	0.214E-22	R(29) P	65	603.381 01(11)*	905.56	0.418E-21	R(27) H					
31	600.760 16(14)	138.44	0.389E-22	R(18) R	66	603.520 67(9)	702.77	0.680E-21	R(16) B					
32	600.766 06(11)*	840.21	0.492E-21	R(24) H	67	603.611 16(6)	1292.01	0.670E-22	R(16) E					
33	600.766 61(9)	665.20	0.716E-21	R(13) C	68	603.615 60(6)	1292.01	0.670E-22	R(16) F					
34	600.886 65(11)	1399.85	0.631E-22	R(23) G	69	603.729 86(9)*	1322.45	0.186E-22	R(9) D					
35	600.913 33(9)	665.05	0.697E-21	R(13) B	70	603.904 89(8)*	128.20	0.110E-19	R(17) A					

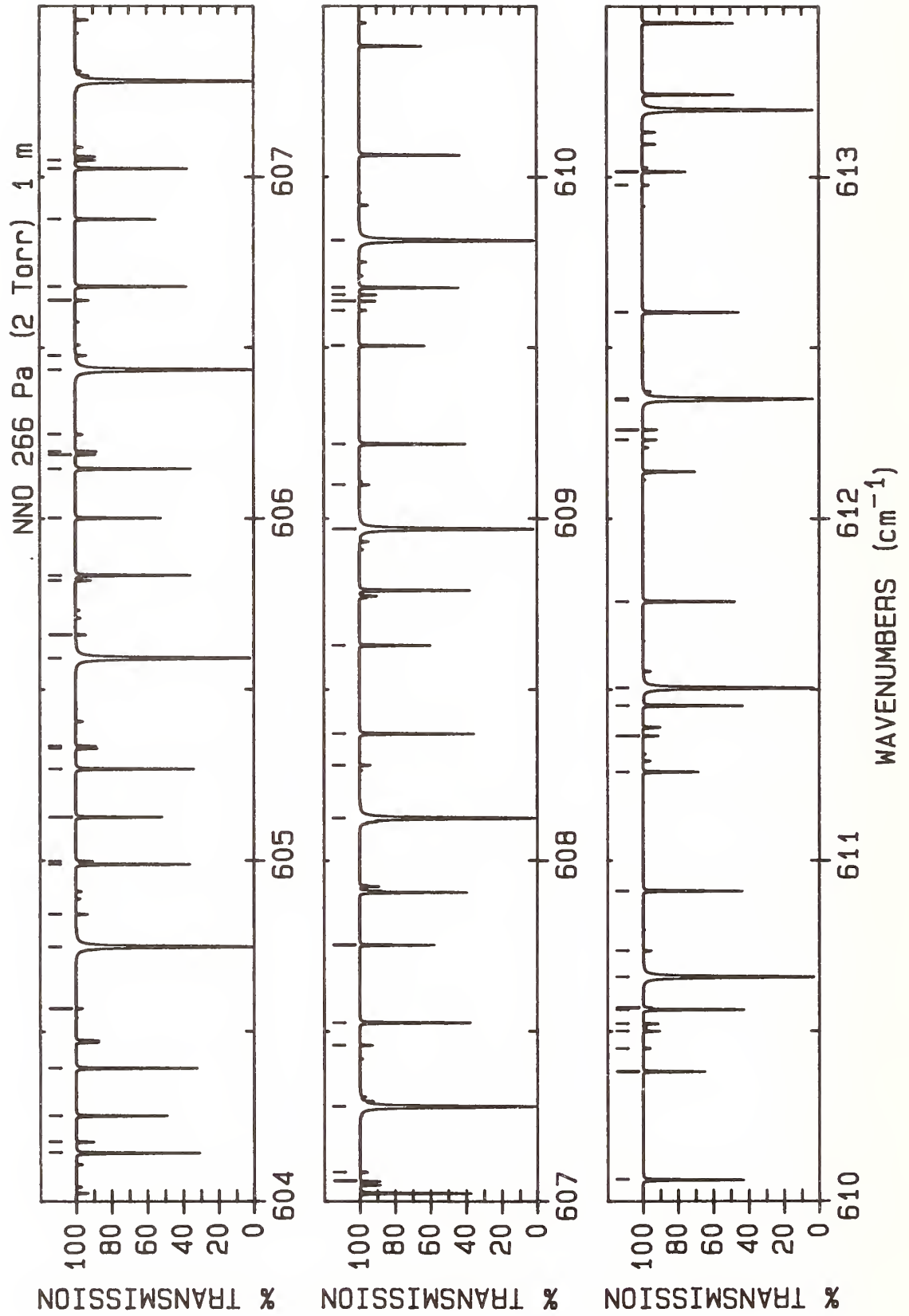

LINE #	WAVENUMBER(cm ⁻¹)	LOWER STATE (cm ⁻¹)	INTENSITY (cm/molecule)	ASSIGNMENT ROTATION BAND	LINE #	WAVENUMBER(unc) (cm ⁻¹)	LOWER STATE (cm ⁻¹)	INTENSITY (cm/molecule)	ASSIGNMENT ROTATION BAND
1	604.144 62(9)	717.26	0.698E-21	R(17) C	36	608.125 17(8)*	211.97	0.946E-20	R(22) A
2	604.177 45(11)	1485.45	0.499E-22	R(27) G	37	608.279 88(11)	1611.29	0.331E-22	R(32) G
3	604.254 19(11)*	929.02	0.391E-21	R(28) H	38	608.372 18(9)	801.23	0.587E-21	R(22) C
4	604.393 81(9)	717.02	0.666E-21	R(17) B	39	608.629 49(11)*	1058.86	0.262E-21	R(33) H
5	604.568 74(9)*	1330.80	0.196E-22	R(10) D	40	608.969 91(8)*	231.24	0.901E-20	R(23) A
6	604.748 47(8)*	143.28	0.108E-19	R(18) A	41	609.099 06(11)	1638.97	0.301E-22	R(33) G
7	604.843 34(14)	223.43	0.329E-22	R(23) R	42	609.218 31(9)	820.54	0.558E-21	R(23) C
8	604.989 70(9)	732.38	0.682E-21	R(18) C	43	609.506 10(11)*	1087.34	0.238E-21	R(34) H
9	604.998 87(11)	1508.94	0.464E-22	R(28) G	44	609.609 62(9)*	1398.38	0.218E-22	R(16) D
10	605.128 06(11)*	953.32	0.365E-21	R(29) H	45	609.637 09(6)	1409.62	0.506E-22	R(23) E
11	605.269 00(9)	732.11	0.647E-21	R(18) B	46	609.655 46(6)	1409.60	0.506E-22	R(23) F
12	605.328 74(6)	1321.41	0.636E-22	R(18) E	47	609.676 37(9)	820.10	0.511E-21	R(23) B
13	605.335 78(6)	1321.41	0.636E-22	R(18) F	48	609.814 87(8)*	251.34	0.854E-20	R(24) A
14	605.592 29(8)*	159.20	0.105E-19	R(19) A	49	610.064 63(9)	840.68	0.527E-21	R(24) C
15	605.660 75(14)	242.85	0.313E-22	R(24) R	50	610.383 12(11)*	1116.65	0.215E-21	R(35) H
16	605.819 80(11)	1533.28	0.430E-22	R(29) G	51	610.450 98(9)*	1412.57	0.215E-22	R(17) D
17	605.835 00(9)	748.33	0.663E-21	R(19) C	52	610.501 04(6)	1429.78	0.476E-22	R(24) E
18	606.002 57(11)*	978.45	0.338E-21	R(30) H	53	610.522 75(6)	1429.76	0.475E-22	R(24) F
19	606.146 25(9)	748.03	0.625E-21	R(19) B	54	610.564 29(9)	840.21	0.479E-21	R(24) B
20	606.188 81(6)	1337.38	0.614E-22	R(19) E	55	610.570 19(14)	376.38	0.207E-22	R(30) R
21	606.197 50(6)	1337.37	0.614E-22	R(19) F	56	610.660 04(8)*	272.28	0.805E-20	R(25) A
22	606.247 60(9)*	1349.99	0.210E-22	R(12) D	57	610.736 26(11)	1696.84	0.244E-22	R(35) G
23	606.436 35(8)*	175.95	0.102E-19	R(20) A	58	610.911 14(9)	861.67	0.495E-21	R(25) C
24	606.478 40(14)	263.09	0.296E-22	R(25) R	59	611.260 48(11)*	1146.80	0.194E-21	R(36) H
25	606.640 27(11)	1558.45	0.396E-22	R(30) G	60	611.365 69(6)	1450.78	0.445E-22	R(25) E
26	606.680 52(9)	765.12	0.641E-21	R(20) C	61	611.454 42(9)	861.16	0.446E-21	R(25) B
27	606.877 68(11)*	1004.42	0.312E-21	R(31) H	62	611.505 41(8)*	294.06	0.754E-20	R(26) A
28	607.025 60(9)	764.79	0.600E-21	R(20) B	63	611.757 83(9)	883.50	0.463E-21	R(26) C
29	607.049 71(6)	1354.18	0.590E-22	R(20) E	64	612.231 02(6)	1472.61	0.414E-22	R(26) E
30	607.060 33(6)	1354.16	0.590E-22	R(20) F	65	612.260 74(6)	1472.58	0.413E-22	R(26) F
31	607.087 58(9)*	1360.84	0.215E-22	R(13) D	66	612.346 79(9)	882.94	0.414E-21	R(26) B
32	607.280 65(8)*	193.54	0.987E-20	R(21) A	67	612.350 99(8)*	316.67	0.703E-20	R(27) A
33	607.460 29(11)	1584.45	0.363E-22	R(31) G	68	612.604 70(9)	906.16	0.430E-21	R(27) C
34	607.526 25(9)	782.76	0.615E-21	R(21) C	69	612.977 08(9)*	1460.12	0.201E-22	R(20) D
35	607.753 33(11)*	1031.22	0.287E-21	R(32) H	70	613.016 09(11)*	1209.60	0.155E-21	R(38) H

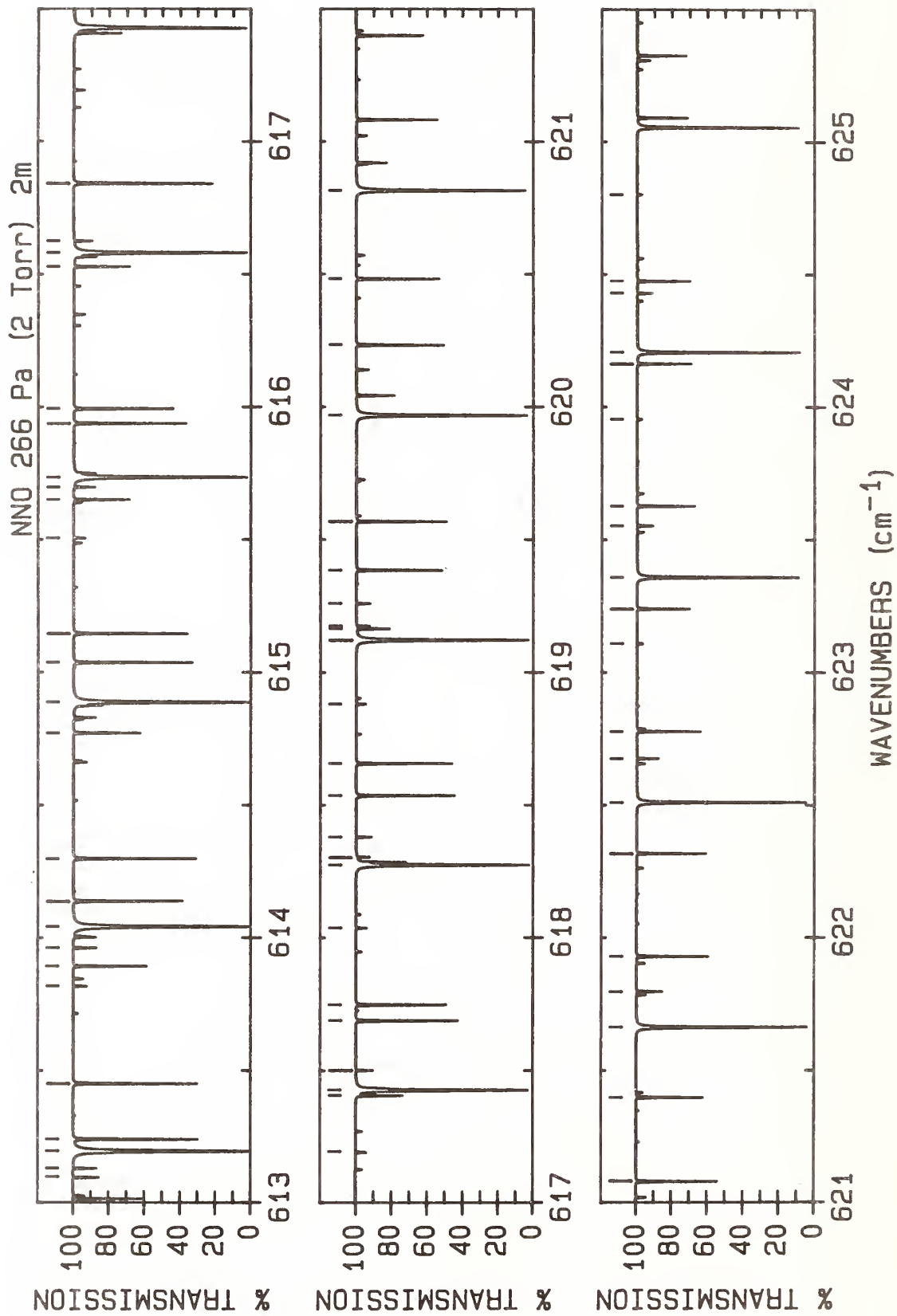

LINE #	WAVENUMBER(unc) (cm ⁻¹)	LOWER STATE (cm ⁻¹)	INTENSITY (cm/molecule)	ASSIGNMENT ROTATION BAND	LINE #	WAVENUMBER(unc) (cm ⁻¹)	LOWER STATE (cm ⁻¹)	INTENSITY (cm/molecule)	ASSIGNMENT ROTATION BAND
1	613.097 00(6)	1495.29	0.383E-22	R(27) E	36	618.380 65(14)	1648.90	0.216E-22	R(33) F
2	613.131 46(6)	1495.26	0.382E-22	R(27) F	37	618.537 24(8)	1088.28	0.225E-21	R(34) C
3	613.196 75(8)*	340.12	0.652E-20	R(28) A	38	618.658 19(9)	1058.86	0.209E-21	R(33) B
4	613.241 41(9)	905.56	0.381E-21	R(27) B	39	618.882 23(9)*	1600.25	0.138E-22	R(27) D
5	613.451 74(9)	929.66	0.398E-21	R(28) C	40	619.122 05(8)*	527.67	0.334E-20	R(35) A
6	613.819 75(9)*	1477.64	0.194E-22	R(21) D	41	619.164 61(12)*	1455.70	0.609E-22	R(45) H
7	613.894 22(11)*	1242.25	0.138E-21	R(39) H	42	619.174 59(18)	1677.52	0.194E-22	R(34) E
8	613.963 59(7)	1518.81	0.353E-22	R(28) E	43	619.259 77(18)	1677.44	0.193E-22	R(34) F
9	614.042 71(8)*	364.41	0.602E-20	R(29) A	44	619.385 31(8)	1117.64	0.201E-21	R(35) C
10	614.138 32(9)	929.02	0.350E-21	R(28) B	45	619.569 44(9)	1087.34	0.185E-21	R(34) B
11	614.298 95(9)	954.01	0.366E-21	R(29) C	46	619.969 16(8)*	557.81	0.298E-20	R(36) A
12	614.772 51(11)*	1275.74	0.121E-21	R(40) H	47	620.233 51(8)	1147.85	0.178E-21	R(36) C
13	614.888 85(8)*	389.53	0.552E-20	R(30) A	48	620.483 17(9)	1116.65	0.164E-21	R(35) B
14	615.037 55(9)	953.32	0.319E-21	R(29) B	49	620.816 40(8)*	588.78	0.264E-20	R(37) A
15	615.146 31(8)	979.18	0.335E-21	R(30) C	50	621.081 82(8)	1178.89	0.158E-21	R(37) C
16	615.506 05(9)*	1515.18	0.177E-22	R(23) D	51	621.399 43(9)	1146.80	0.144E-21	R(36) B
17	615.650 91(11)*	1310.06	0.107E-21	R(41) H	52	621.663 78(8)*	620.59	0.233E-20	R(38) A
18	615.698 53(8)	1568.36	0.295E-22	R(30) E	53	621.798 66(12)*	1573.69	0.381E-22	R(48) H
19	615.735 16(8)*	415.49	0.504E-20	R(31) A	54	621.930 24(8)	1210.77	0.139E-21	R(38) C
20	615.939 12(9)	978.45	0.289E-21	R(30) B	55	622.318 24(9)	1177.78	0.126E-21	R(37) B
21	615.993 83(8)	1005.20	0.306E-21	R(31) C	56	622.511 28(8)*	653.23	0.205E-20	R(39) A
22	616.529 37(11)*	1345.22	0.935E-22	R(42) H	57	622.676 20(12)*	1614.68	0.323E-22	R(49) H
23	616.581 64(8)*	442.28	0.458E-20	R(32) A	58	622.778 77(9)	1243.48	0.122E-21	R(39) C
24	616.626 10(10)	1594.33	0.267E-22	R(31) F	59	623.108 74(9)*	1725.33	0.904E-23	R(32) D
25	616.841 49(8)	1032.06	0.277E-21	R(32) C	60	623.239 62(9)	1209.60	0.109E-21	R(38) B
26	616.843 06(9)	1004.42	0.261E-21	R(31) B	61	623.358 90(8)*	686.70	0.179E-20	R(40) A
27	617.193 55(9)*	1556.05	0.158E-22	R(25) D	62	623.553 42(12)*	1656.51	0.273E-22	R(50) H
28	617.407 84(11)*	1381.21	0.814E-22	R(43) H	63	623.627 39(9)	1277.04	0.107E-21	R(40) C
29	617.428 29(8)*	469.91	0.414E-20	R(33) A	64	623.954 82(9)*	1752.85	0.818E-23	R(33) D
30	617.502 76(12)	1621.19	0.241E-22	R(32) F	65	624.163 62(9)	1242.25	0.948E-22	R(39) B
31	617.689 30(8)	1059.75	0.250E-21	R(33) C	66	624.206 64(8)*	721.01	0.156E-20	R(41) A
32	617.749 41(9)	1031.22	0.234E-21	R(32) B	67	624.430 29(13)*	1699.17	0.229E-22	R(51) H
33	618.037 75(9)*	1577.73	0.148E-22	R(26) D	68	624.476 10(9)	1311.42	0.928E-22	R(41) C
34	618.275 10(8)*	498.37	0.373E-20	R(34) A	69	624.801 15(9)*	1781.19	0.736E-23	R(34) D
35	618.304 87(14)	1648.97	0.217E-22	R(33) E					

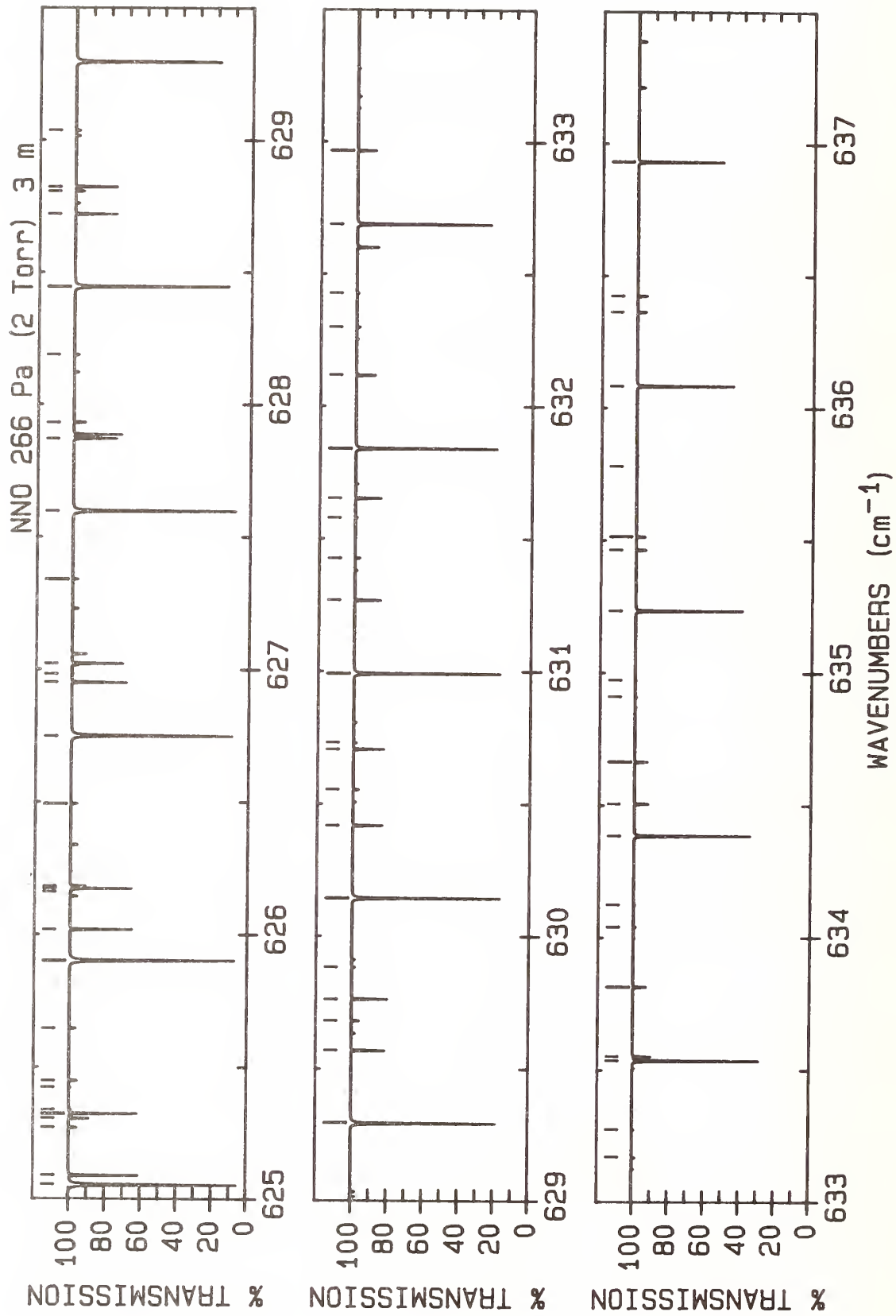

LINE #	WAVENUMBER(unc) (cm ⁻¹)	LOWER STATE (cm ⁻¹)	INTENSITY (cm/molecule)	ASSIGNMENT ROTATION BAND	LINE #	WAVENUMBER(unc) (cm ⁻¹)	LOWER STATE (cm ⁻¹)	INTENSITY (cm/molecule)	ASSIGNMENT ROTATION BAND	LINE #	WAVENUMBER(unc) (cm ⁻¹)	LOWER STATE (cm ⁻¹)	INTENSITY (cm/molecule)	ASSIGNMENT ROTATION BAND
1	625.054 49(8)*	756.16	0.135E-20	R(42) A	36	630.419 11(16)	1575.55	0.306E-22	R(48) C	41	631.268 31(18)	1616.62	0.257E-22	R(49) C
2	625.090 26(9)	1275.74	0.816E-22	R(40) B	37	630.555 03(15)*	2021.11	0.595E-23	R(58) H	42	631.427 64(15)*	2070.42	0.482E-23	R(59) H
3	625.272 53(68)	1900.83	0.780E-23	R(41) E	38	630.706 95(9)	1494.20	0.301E-22	R(46) B	43	631.579 87(9)*	2037.90	0.268E-23	R(42) D
4	625.306 76(13)*	1742.67	0.191E-22	R(52) H	39	630.731 80(9)*	2002.90	0.309E-23	R(41) D	44	631.652 78(9)	1533.53	0.251E-22	R(47) B
5	625.324 91(9)	1346.65	0.803E-22	R(42) C	40	630.991 88(9)*	1025.52	0.436E-21	R(49) A	45	631.840 35(10)*	1067.33	0.365E-21	R(50) A
6	625.339 92(43)	951.32	0.214E-23	R(48) R	41	631.268 31(18)	1616.62	0.257E-22	R(49) C	46	632.117 53(20)	1658.53	0.214E-22	R(50) C
7	625.424 21(14)	2367.97	0.164E-23	R(53) G	42	631.427 64(15)*	2070.42	0.482E-23	R(59) H	47	632.299 56(16)*	2120.57	0.388E-23	R(60) H
8	625.449 67(68)	1900.66	0.772E-23	R(41) F	43	631.579 87(9)*	2037.90	0.268E-23	R(42) D	48	632.428 12(9)*	2073.73	0.231E-23	R(43) D
9	625.647 71(9)*	1810.37	0.660E-23	R(35) D	44	631.652 78(9)	1533.53	0.251E-22	R(47) B	49	632.688 87(10)*	1109.98	0.303E-21	R(51) A
10	625.902 44(8)*	792.14	0.117E-20	R(43) A	45	631.840 35(10)*	1067.33	0.365E-21	R(50) A	50	632.966 78(22)	1701.27	0.178E-22	R(51) C
11	626.019 56(9)	1310.06	0.700E-22	R(41) B	46	632.117 53(20)	1658.53	0.214E-22	R(50) C	51	633.170 75(16)*	2171.55	0.312E-23	R(61) H
12	626.161 83(46)	990.92	0.181E-23	R(49) R	47	632.299 56(16)*	2120.57	0.388E-23	R(60) H	52	633.276 56(9)*	2110.39	0.199E-23	R(44) D
13	626.173 78(10)	1382.71	0.691E-22	R(43) C	48	632.428 12(9)*	2073.73	0.231E-23	R(43) D	53	633.537 43(10)*	1153.46	0.251E-21	R(52) A
14	626.182 79(13)*	1786.99	0.159E-22	R(53) H	49	632.688 87(10)*	1109.98	0.303E-21	R(51) A	54	633.552 96(10)	1614.68	0.171E-22	R(49) B
15	626.494 51(9)*	1840.38	0.588E-23	R(36) D	50	632.966 78(22)	1701.27	0.178E-22	R(51) C	55	633.816 04(25)	1744.84	0.147E-22	R(52) C
16	626.750 48(8)*	828.95	0.100E-20	R(44) A	51	633.170 75(16)*	2171.55	0.312E-23	R(61) H	56	634.041 19(17)*	2223.36	0.249E-23	R(62) H
17	626.951 55(9)	1345.22	0.597E-22	R(42) B	52	633.276 56(9)*	2110.39	0.199E-23	R(44) D	57	634.125 17(9)*	2147.88	0.170E-23	R(45) D
18	626.983 84(50)	1031.32	0.153E-23	R(50) R	53	633.537 43(10)*	1153.46	0.251E-21	R(52) A	58	634.386 02(10)*	1197.77	0.207E-21	R(53) A
19	627.022 73(11)	1419.61	0.593E-22	R(44) C	54	633.552 96(10)	1614.68	0.171E-22	R(49) B	59	634.507 36(10)	1656.51	0.141E-22	R(50) B
20	627.341 54(9)*	1871.22	0.522E-23	R(37) D	55	633.816 04(25)	1744.84	0.147E-22	R(52) C	60	634.665 31(28)	1789.25	0.122E-22	R(53) C
21	627.598 61(9)*	866.60	0.855E-21	R(45) A	56	634.041 19(17)*	2223.36	0.249E-23	R(62) H	61	634.910 85(17)*	2275.99	0.198E-23	R(63) H
22	627.871 75(12)	1457.34	0.506E-22	R(45) C	57	634.125 17(9)*	2147.88	0.170E-23	R(45) D	62	634.973 95(9)*	2186.20	0.145E-23	R(46) D
23	627.933 38(14)*	1878.14	0.109E-22	R(55) H	58	634.386 02(10)*	1197.77	0.207E-21	R(53) A	63	635.234 64(11)*	1242.91	0.170E-21	R(54) A
24	628.188 79(9)*	1902.90	0.461E-23	R(38) D	59	634.507 36(10)	1656.51	0.141E-22	R(50) B	64	635.464 64(11)	1699.17	0.115E-22	R(51) B
25	628.446 82(9)*	905.08	0.728E-21	R(46) A	60	634.665 31(28)	1789.25	0.122E-22	R(53) C	65	635.514 56(32)	1834.50	0.997E-23	R(54) C
26	628.720 82(13)	1495.90	0.430E-22	R(46) C	61	634.910 85(17)*	2275.99	0.198E-23	R(63) H	66	635.779 70(18)*	2329.46	0.157E-23	R(64) H
27	628.807 87(14)*	1924.97	0.894E-23	R(56) H	62	634.973 95(9)*	2186.20	0.145E-23	R(46) D	67	636.083 28(11)*	1288.88	0.139E-21	R(55) A
28	628.823 71(9)	1418.04	0.428E-22	R(44) B	63	635.234 64(11)*	1242.91	0.170E-21	R(54) A	68	636.363 81(36)	1880.57	0.814E-23	R(55) C
29	629.036 25(9)*	1935.40	0.405E-23	R(39) D	64	635.464 64(11)	1699.17	0.115E-22	R(51) B	69	636.424 82(11)	1742.67	0.935E-23	R(52) B
30	629.295 11(9)*	944.39	0.616E-21	R(47) A	65	635.514 56(32)	1834.50	0.997E-23	R(54) C	70	636.931 93(12)*	1335.69	0.113E-21	R(56) A
31	629.569 94(14)	1535.31	0.364E-22	R(47) C	66	635.779 70(18)*	2329.46	0.157E-23	R(64) H					
32	629.681 76(14)*	1972.62	0.730E-23	R(57) H	67	636.083 28(11)*	1288.88	0.139E-21	R(55) A					
33	629.763 94(9)	1455.70	0.360E-22	R(45) B	68	636.363 81(36)	1880.57	0.814E-23	R(55) C					
34	629.883 93(9)*	1968.74	0.355E-23	R(40) D	69	636.424 82(11)	1742.67	0.935E-23	R(52) B					
35	630.143 46(9)*	984.54	0.519E-21	R(48) A	70	636.931 93(12)*	1335.69	0.113E-21	R(56) A					

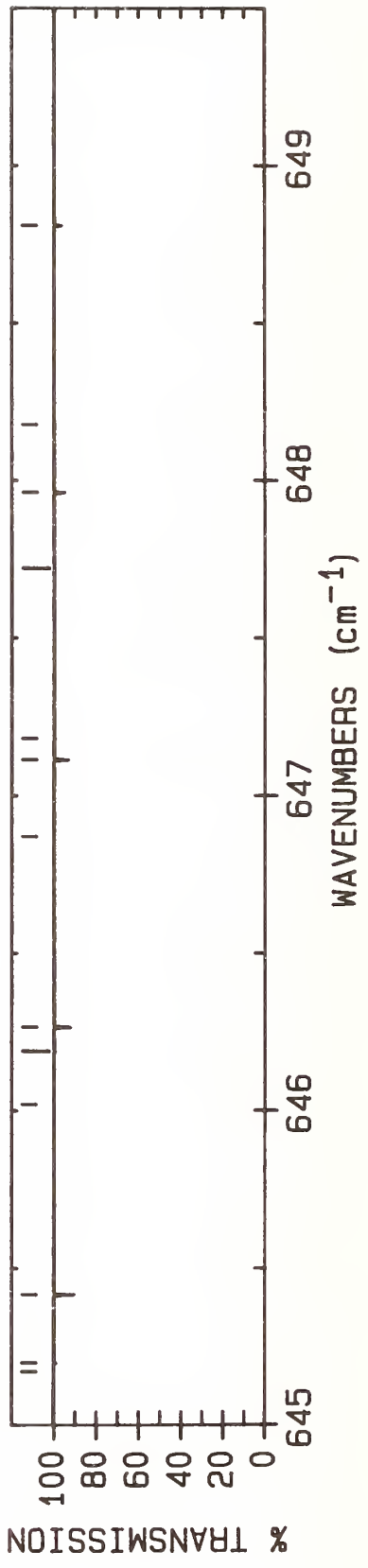
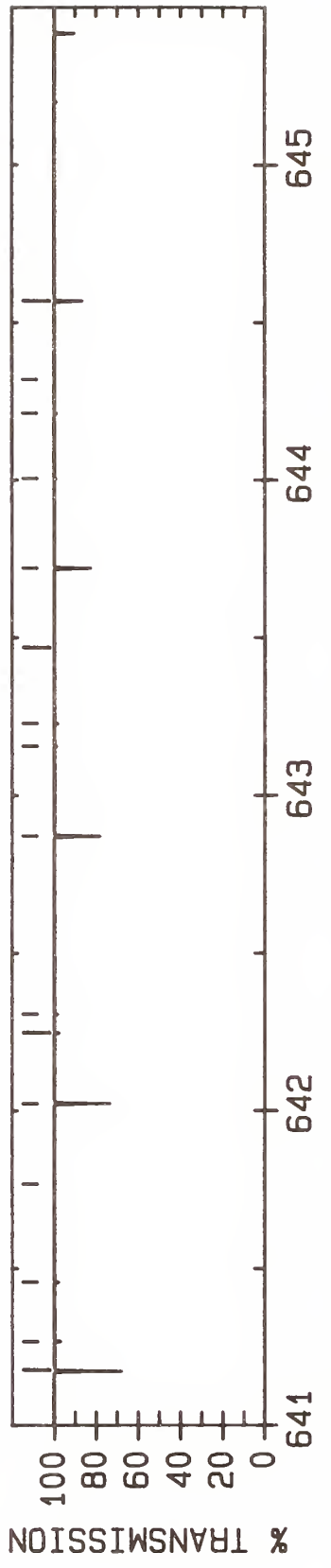
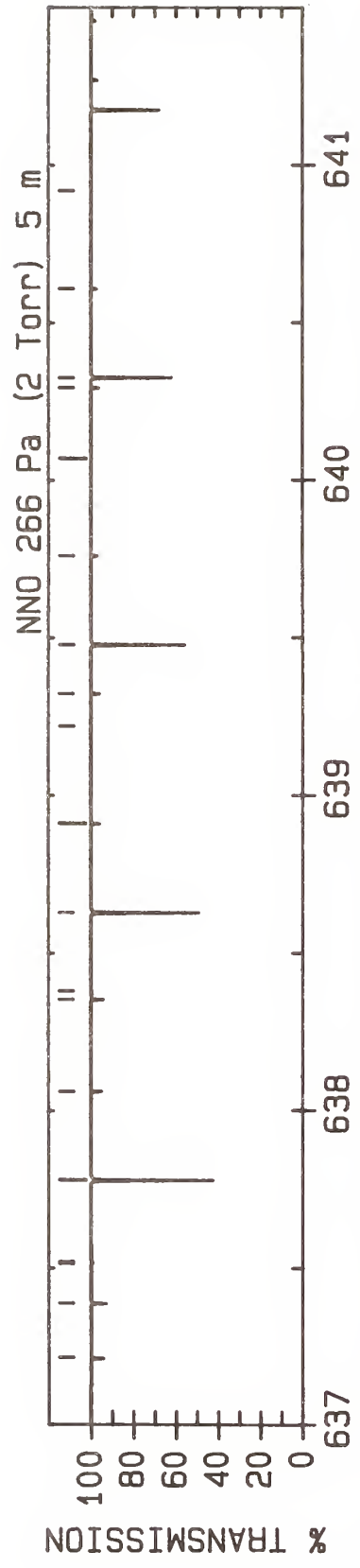

LINE #	WAVENUMBER(unc) (cm ⁻¹)	LOWER STATE (cm ⁻¹)	INTENSITY (cm/molecule)	ASSIGNMENT ROTATION BAND	LINE #	WAVENUMBER(unc) (cm ⁻¹)	LOWER STATE (cm ⁻¹)	INTENSITY (cm/molecule)	ASSIGNMENT ROTATION BAND	LINE #	WAVENUMBER(unc) (cm ⁻¹)	LOWER STATE (cm ⁻¹)	INTENSITY (cm/molecule)	ASSIGNMENT ROTATION BAND
1	637.213 03(40)	1927.48	0.662E-23	R(56) C	26	642.307 37(78)	2226.43	0.175E-23	R(62) C	26	642.307 37(78)	2226.43	0.175E-23	R(62) C
2	637.387 92(11)	1786.99	0.757E-23	R(53) B	27	642.872 22(15)*	1686.59	0.238E-22	R(63) A	27	642.872 22(15)*	1686.59	0.238E-22	R(63) A
3	637.514 86(19)*	2438.88	0.973E-24	R(66) H	28	643.156 16(87)	2279.17	0.138E-23	R(63) C	28	643.156 16(87)	2279.17	0.138E-23	R(63) C
4	637.521 23(10)*	2306.14	0.870E-24	R(49) D	29	643.228 34(14)	2070.42	0.193E-23	R(59) B	29	643.228 34(14)	2070.42	0.193E-23	R(59) B
5	637.780 59(12)*	1383.33	0.919E-22	R(57) A	30	643.469 40(12)*	2615.03	0.228E-24	R(56) D	30	643.469 40(12)*	2615.03	0.228E-24	R(56) D
6	638.062 23(45)	1975.23	0.536E-23	R(57) C	31	643.720 71(16)*	1740.04	0.187E-22	R(64) A	31	643.720 71(16)*	1740.04	0.187E-22	R(64) A
7	638.353 95(12)	1832.15	0.610E-23	R(54) B	32	644.004 85(96)	2332.74	0.109E-23	R(64) C	32	644.004 85(96)	2332.74	0.109E-23	R(64) C
8	638.381 12(20)*	2494.84	0.761E-24	R(67) H	33	644.212 09(15)	2120.57	0.152E-23	R(60) B	33	644.212 09(15)	2120.57	0.152E-23	R(60) B
9	638.629 24(12)*	1431.79	0.742E-22	R(58) A	34	644.319 55(12)*	2662.47	0.185E-24	R(57) D	34	644.319 55(12)*	2662.47	0.185E-24	R(57) D
10	638.911 38(50)	2023.80	0.432E-23	R(58) C	35	644.569 14(16)*	1794.32	0.147E-22	R(65) A	35	644.569 14(16)*	1794.32	0.147E-22	R(65) A
11	639.220 12(10)*	2390.25	0.606E-24	R(51) D	36	645.169 77(13)*	2710.73	0.149E-24	R(58) D	36	645.169 77(13)*	2710.73	0.149E-24	R(58) D
12	639.322 93(12)	1878.14	0.489E-23	R(55) B	37	645.198 80(15)	2171.55	0.118E-23	R(61) B	37	645.198 80(15)	2171.55	0.118E-23	R(61) B
13	639.477 88(13)*	1481.09	0.596E-22	R(59) A	38	645.417 52(17)*	1849.42	0.114E-22	R(66) A	38	645.417 52(17)*	1849.42	0.114E-22	R(66) A
14	639.760 48(56)	2073.21	0.347E-23	R(59) C	39	646.020 06(13)*	2759.83	0.120E-24	R(59) D	39	646.020 06(13)*	2759.83	0.120E-24	R(59) D
15	640.069 76(11)*	2433.55	0.503E-24	R(52) D	40	646.188 47(16)	2223.36	0.920E-24	R(62) B	40	646.188 47(16)	2223.36	0.920E-24	R(62) B
16	640.294 84(13)	1924.97	0.391E-23	R(56) B	41	646.265 82(18)*	1905.36	0.888E-23	R(67) A	41	646.265 82(18)*	1905.36	0.888E-23	R(67) A
17	640.326 51(13)*	1531.22	0.477E-22	R(60) A	42	646.870 42(14)*	2809.75	0.961E-25	R(60) D	42	646.870 42(14)*	2809.75	0.961E-25	R(60) D
18	640.609 52(63)	2123.45	0.277E-23	R(60) C	43	647.114 04(18)*	1962.12	0.687E-23	R(68) A	43	647.114 04(18)*	1962.12	0.687E-23	R(68) A
19	640.919 51(11)*	2477.68	0.415E-24	R(53) D	44	647.181 09(16)	2275.99	0.712E-24	R(63) B	44	647.181 09(16)	2275.99	0.712E-24	R(63) B
20	641.175 12(14)*	1582.18	0.380E-22	R(61) A	45	647.720 82(14)*	2860.50	0.766E-25	R(61) D	45	647.720 82(14)*	2860.50	0.766E-25	R(61) D
21	641.269 72(13)	1972.62	0.310E-23	R(57) B	46	647.962 18(19)*	2019.71	0.529E-23	R(69) A	46	647.962 18(19)*	2019.71	0.529E-23	R(69) A
22	641.458 48(70)	2174.53	0.221E-23	R(61) C	47	648.176 65(17)	2329.46	0.548E-24	R(64) B	47	648.176 65(17)	2329.46	0.548E-24	R(64) B
23	641.769 38(11)*	2522.63	0.341E-24	R(54) D	48	648.810 23(20)*	2078.13	0.405E-23	R(70) A	48	648.810 23(20)*	2078.13	0.405E-23	R(70) A
24	642.023 69(15)*	1633.97	0.301E-22	R(62) A										
25	642.247 55(14)	2021.11	0.245E-23	R(58) B										

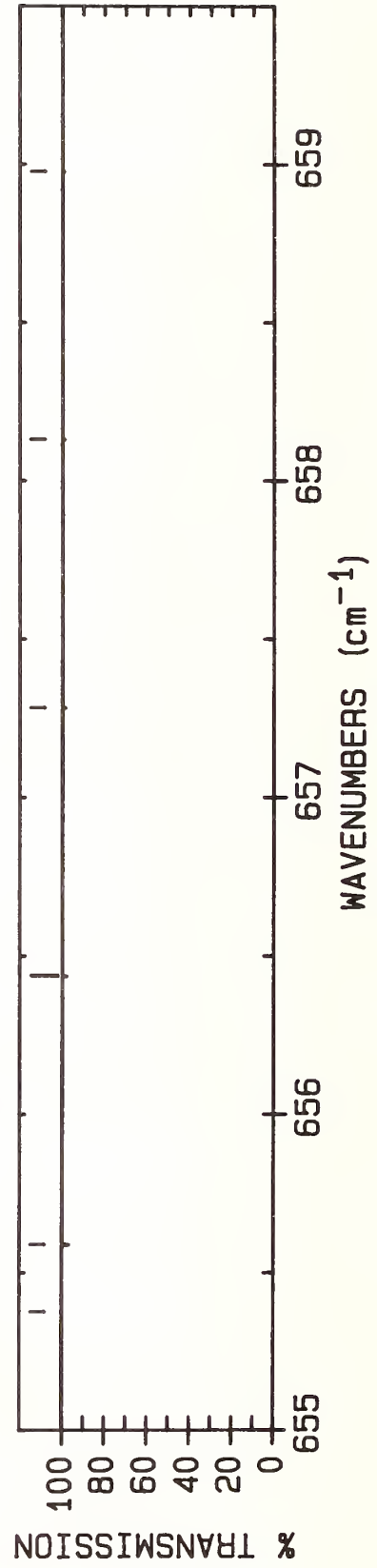
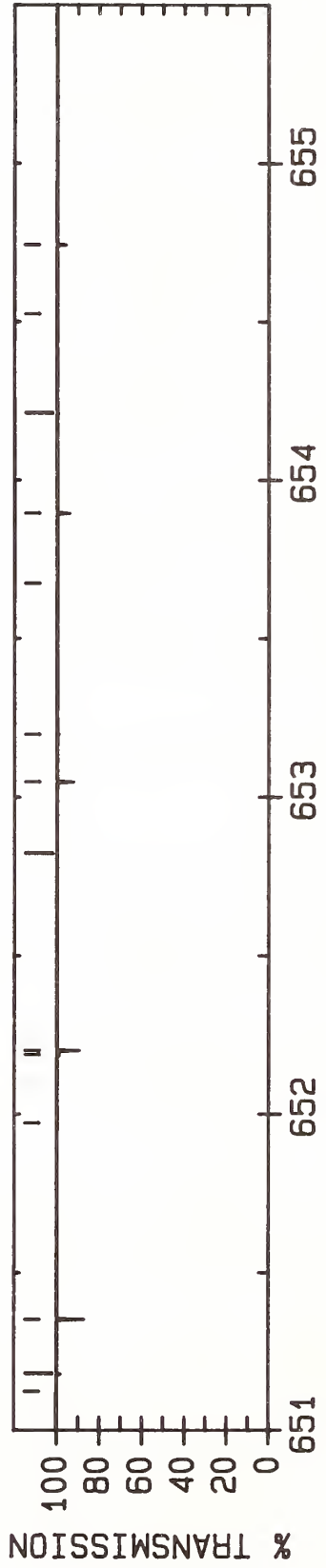
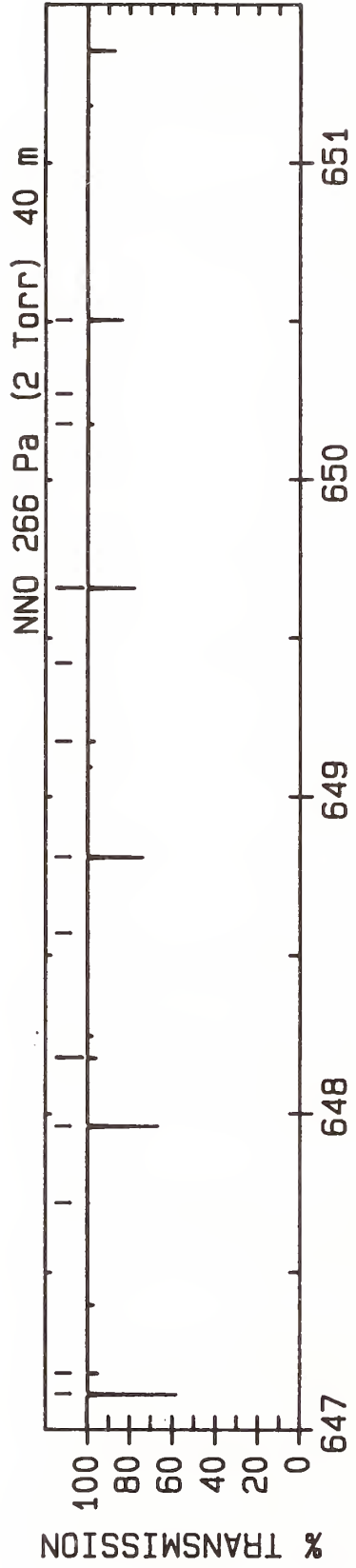

LINE #	WAVENUMBER(unc) (cm ⁻¹)	LOWER STATE (cm ⁻¹)	INTENSITY (cm/molecule)	ASSIGNMENT ROTATION BAND	LINE #	WAVENUMBER(unc) (cm ⁻¹)	LOWER STATE (cm ⁻¹)	INTENSITY (cm/molecule)	ASSIGNMENT ROTATION BAND
1	647.114 04(18)*	1962.12	0.687E-23	R(68) A	21	653.048 82(25)	2382.64	0.101E-23	R(75) A
2	647.181 09(16)	2275.99	0.712E-24	R(63) B	22	653.198 19(25)	2609.24	0.139E-24	R(69) B
3	647.720 82(14)*	2860.50	0.766E-25	R(61) D	23	653.674 44(19)*	3238.88	0.140E-25	R(68) D
4	647.962 18(19)*	2019.71	0.529E-23	R(69) A	24	653.896 15(27)	2446.02	0.754E-24	R(76) A
5	648.176 65(17)	2329.46	0.548E-24	R(64) B	25	654.211 14(28)	2667.68	0.105E-24	R(70) B
6	648.571 28(15)*	2912.08	0.609E-25	R(62) D	26	654.524 96(20)*	3296.24	0.108E-25	R(69) D
7	648.810 23(20)*	2078.13	0.405E-23	R(70) A	27	654.743 33(28)	2510.22	0.561E-24	R(77) A
8	649.175 14(18)	2383.76	0.420E-24	R(65) B	28	655.375 45(20)*	3354.41	0.826E-26	R(70) D
9	649.421 77(15)*	2964.48	0.481E-25	R(63) D	29	655.590 35(30)	2575.26	0.416E-24	R(78) A
10	649.658 18(21)	2137.38	0.310E-23	R(71) A	30	656.437 21(31)	2641.11	0.307E-24	R(79) A
11	650.176 56(19)	2438.88	0.321E-24	R(66) B	31	657.283 90(33)	2707.79	0.226E-24	R(80) A
12	650.272 28(16)*	3017.71	0.379E-25	R(64) D	32	658.130 41(35)	2775.30	0.165E-24	R(81) A
13	650.506 02(22)	2197.45	0.235E-23	R(72) A	33	658.976 73(37)	2843.63	0.121E-24	R(82) A
14	651.122 82(17)*	3071.76	0.297E-25	R(65) D					
15	651.180 88(21)	2494.84	0.244E-24	R(67) B					
16	651.353 75(23)	2258.36	0.178E-23	R(73) A					
17	651.973 36(17)*	3126.64	0.232E-25	R(66) D					
18	652.188 10(23)	2551.62	0.185E-24	R(68) B					
19	652.201 35(24)	2320.08	0.134E-23	R(74) A					
20	652.823 90(18)*	3182.35	0.180E-25	R(67) D					

ATLAS OF N₂O ABSORPTION LINES FROM 880 cm⁻¹ to 1087 cm⁻¹

key:

Band	Isotopomer	Vibrational Transition
A	¹⁴ N ¹⁴ N ¹⁶ O	10 ⁰ 0-00 ⁰ 1
B		11 ¹ 0-01 ^{1e} 1
C		11 ¹ 0-01 ^{1f} 1
D		12 ⁰ 0-02 ⁰ 1
E		12 ² 0-02 ^{2e} 1
F		12 ² 0-02 ^{2f} 1
G		10 ⁰ 1-00 ⁰ 2
M		10 ⁰ 0-02 ⁰ 0
N		11 ¹ 0-03 ^{1e} 0
O		11 ¹ 0-03 ^{1f} 0
P	¹⁴ N ¹⁵ N ¹⁶ O	10 ⁰ 0-00 ⁰ 1
R	¹⁵ N ¹⁴ N ¹⁶ O	10 ⁰ 0-00 ⁰ 1
T	¹⁴ N ¹⁴ N ¹⁸ O	10 ⁰ 0-00 ⁰ 1

If the e or f designation is not specified (for $l \neq 0$), then the transition is to either level, depending on the selection rules and the change in the rotational quantum number, J . Spectra are given for a slitwidth of 0.002 cm⁻¹, a temperature of 296 K, and a transition moment of either 0.056 debye (for the $\Delta v_1=1$ and $\Delta v_3=1$ transitions) or 0.018 debye (for the $\Delta v_1=1$ and $\Delta v_2=2$ transitions). No Herman-Wallis constants were used in the calculations.

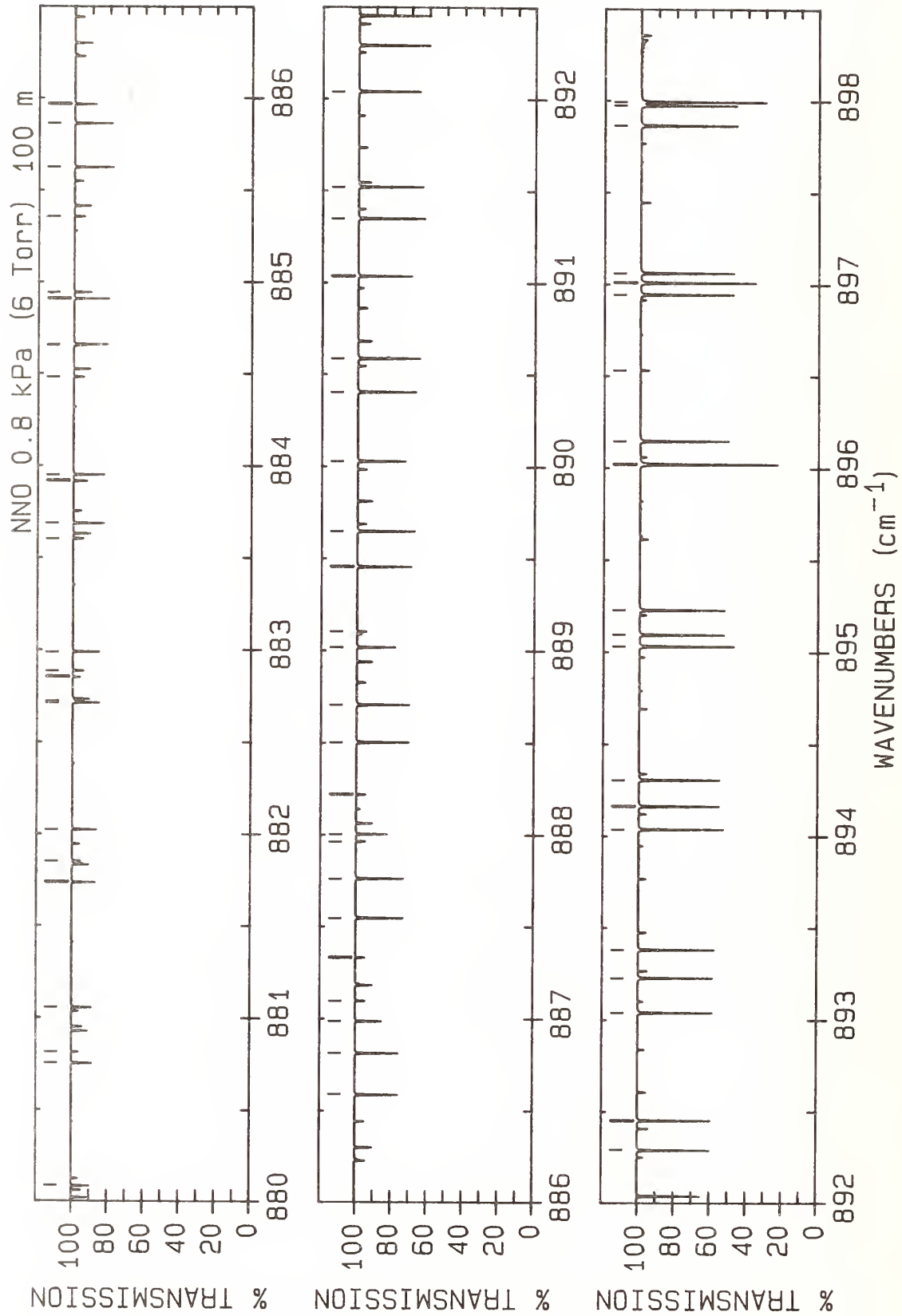

LINE #	WAVENUMBER(unc) (cm ⁻¹)	LOWER STATE (cm ⁻¹)	INTENSITY (cm/molecule)	ASSIGNMENT ROTATION BAND	LINE #	WAVENUMBER(unc) (cm ⁻¹)	LOWER STATE (cm ⁻¹)	INTENSITY (cm/molecule)	ASSIGNMENT ROTATION BAND
1	880.086 096(67)*	2633.64	0.234E-24	P(42) B	36	888.503 777(65)*	2349.46	0.738E-24	P(33) C
2	880.755 137(67)*	2600.20	0.269E-24	P(41) C	37	888.707 414(65)*	2348.44	0.742E-24	P(33) B
3	880.815 725(13)*	2912.08	0.892E-25	P(62) A	38	889.018 502(8)*	2522.63	0.521E-24	P(54) A
4	881.057 146(67)*	2598.62	0.271E-24	P(41) B	39	889.104 0	2562.34	0.120E-24	P(15) D
5	881.736 399(66)*	2565.94	0.310E-24	P(40) C	40	889.456 089(64)*	2321.88	0.819E-24	P(32) C
6	881.852 709(13)*	2860.50	0.113E-24	P(61) A	41	889.648 914(65)*	2320.91	0.824E-24	P(32) B
7	882.024 916(67)*	2564.44	0.312E-24	P(40) B	42	890.028 933(8)*	2477.68	0.637E-24	P(53) A
8	882.714 030(66)*	2532.51	0.356E-24	P(39) C	43	890.404 795(64)*	2295.12	0.905E-24	P(31) C
9	882.723 075(54)	1407.98	0.134E-24	P(17) P	44	890.587 125(64)*	2294.22	0.909E-24	P(31) B
10	882.852 3	2673.52	0.101E-24	P(22) D	45	891.036 060(7)*	2433.55	0.775E-24	P(52) A
11	882.886 359(12)*	2809.75	0.142E-24	P(60) A	46	891.349 896(64)*	2269.20	0.995E-24	P(30) C
12	882.989 406(66)*	2531.09	0.359E-24	P(39) B	47	891.522 045(64)*	2268.36	0.999E-24	P(30) B
13	883.603 905(55)	1393.80	0.135E-24	P(16) P	48	892.039 885(7)*	2390.25	0.939E-24	P(51) A
14	883.688 035(66)*	2499.92	0.407E-24	P(38) C	49	892.291 393(64)*	2244.12	0.109E-23	P(29) C
15	883.916 680(11)*	2759.83	0.178E-24	P(59) A	50	892.453 671(64)*	2243.33	0.109E-23	P(29) B
16	883.950 616(66)*	2498.57	0.410E-24	P(38) B	51	893.040 411(6)*	2347.78	0.113E-23	P(50) A
17	884.481 854(56)	1380.45	0.135E-24	P(15) P	52	893.229 289(64)*	2219.87	0.118E-23	P(28) C
18	884.654 1	2637.58	0.110E-24	P(20) D	53	893.382 002(64)*	2219.13	0.119E-23	P(28) B
19	884.658 416(66)*	2468.16	0.463E-24	P(37) C	54	894.037 638(6)*	2306.14	0.136E-23	P(49) A
20	884.908 543(66)*	2466.88	0.466E-24	P(37) B	55	894.163 583(63)*	2196.46	0.128E-23	P(27) C
21	884.943 677(11)*	2710.73	0.223E-24	P(58) A	56	894.307 036(64)*	2195.77	0.128E-23	P(27) B
22	885.356 920(57)	1367.94	0.134E-24	P(14) P	57	895.031 569(6)*	2265.33	0.163E-23	P(48) A
23	885.625 178(65)*	2437.23	0.524E-24	P(36) C	58	895.094 278(63)*	2173.88	0.138E-23	P(26) C
24	885.863 188(65)*	2436.02	0.527E-24	P(36) B	59	895.228 770(63)*	2173.24	0.138E-23	P(26) B
25	885.967 355(10)*	2662.47	0.277E-24	P(57) A	60	896.021 373(63)*	2152.14	0.147E-23	P(25) C
26	886.588 324(65)*	2407.14	0.590E-24	P(35) C	61	896.022 206(5)*	2225.35	0.194E-23	P(47) A
27	886.814 549(65)*	2405.99	0.594E-24	P(35) B	62	896.147 202(63)*	2151.54	0.148E-23	P(25) B
28	886.987 716(9)*	2615.03	0.344E-24	P(56) A	63	896.532 6	2812.64	0.114E-24	P(24) G
29	887.098 383(60)	1345.42	0.129E-24	P(12) P	64	896.944 870(63)*	2131.23	0.156E-23	P(24) C
30	887.333 4	2589.93	0.118E-24	P(17) D	65	897.009 548(5)*	2186.20	0.230E-23	P(46) A
31	887.547 856(65)*	2377.89	0.662E-24	P(34) C	66	897.062 331(63)*	2130.68	0.157E-23	P(24) B
32	887.762 625(65)*	2376.80	0.666E-24	P(34) B	67	897.864 768(63)*	2111.16	0.165E-23	P(23) C
33	887.964 772(61)	1335.41	0.124E-24	P(11) P	68	897.974 153(63)*	2110.65	0.166E-23	P(23) B
34	888.004 763(9)*	2568.42	0.424E-24	P(55) A	69	897.993 598(5)*	2147.88	0.271E-23	P(45) A
35	888.220 2	2575.72	0.119E-24	P(16) D					

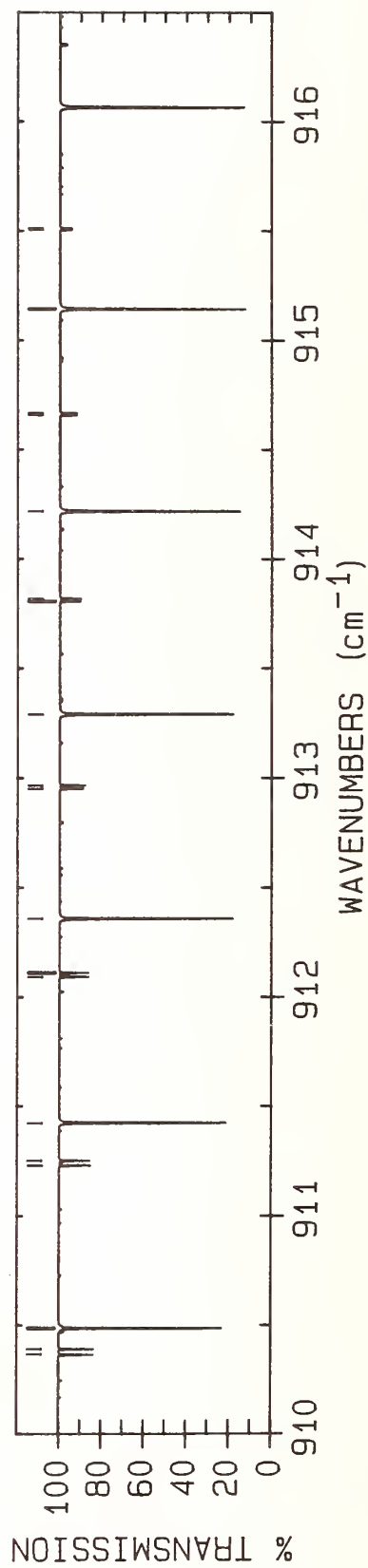
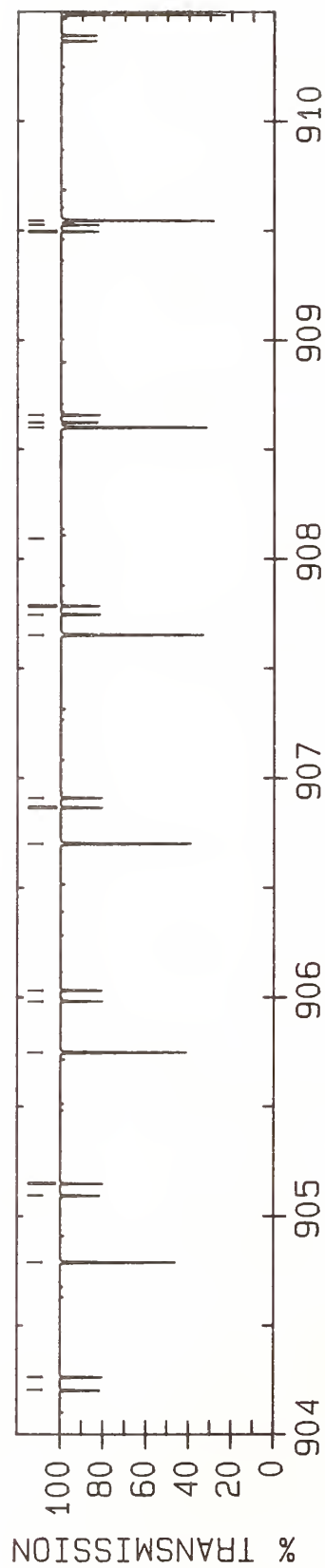
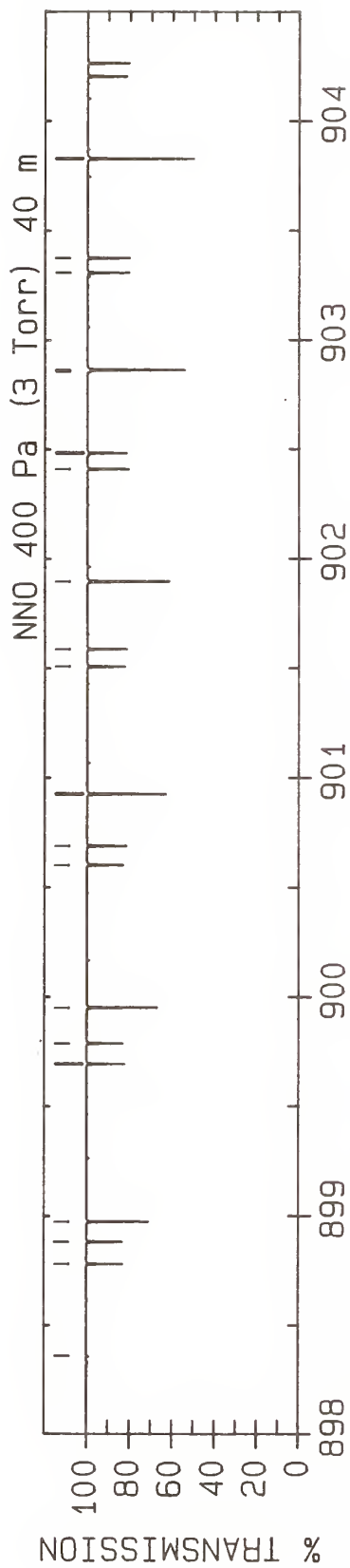

LINE #	WAVENUMBER(unc) (cm ⁻¹)	LOWER STATE (cm ⁻¹)	INTENSITY (cm/molecule)	ASSIGNMENT ROTATION BAND	LINE #	WAVENUMBER(unc) (cm ⁻¹)	LOWER STATE (cm ⁻¹)	INTENSITY (cm/molecule)	ASSIGNMENT ROTATION BAND
1	898.357 6	2773.59	0.126E-24	P(22) G	36	908.092 94(13)*	3460.10	0.337E-29	Q(61) C
2	898.781 067(63)*	2091.92	0.174E-23	P(22) C	37	908.600 911(2)*	1781.19	0.123E-22	P(34) A
3	898.882 667(63)*	2091.46	0.174E-23	P(22) B	38	908.622 654(64)*	1935.49	0.187E-23	P(11) C
4	898.974 356(4)*	2110.39	0.318E-23	P(44) A	39	908.657 137(64)*	1935.37	0.187E-23	P(11) B
5	899.693 768(63)*	2073.52	0.182E-23	P(21) C	40	909.495 698(64)*	1926.29	0.178E-23	P(10) C
6	899.787 869(63)*	2073.10	0.182E-23	P(21) B	41	909.525 721(64)*	1926.18	0.178E-23	P(10) B
7	899.951 822(4)*	2073.73	0.372E-23	P(43) A	42	909.545 456(2)*	1752.85	0.137E-22	P(33) A
8	900.602 869(63)*	2055.95	0.189E-23	P(20) C	43	910.365 127(64)*	1917.92	0.166E-23	P(9) C
9	900.689 757(63)*	2055.57	0.189E-23	P(20) B	44	910.390 955(64)*	1917.84	0.166E-23	P(9) B
10	900.925 997(4)*	2037.90	0.433E-23	P(42) A	45	910.486 705(1)*	1725.33	0.153E-22	P(32) A
11	901.508 371(63)*	2039.22	0.195E-23	P(19) C	46	911.230 937(64)*	1910.39	0.153E-23	P(8) C
12	901.588 328(63)*	2038.88	0.195E-23	P(19) B	47	911.252 838(64)*	1910.32	0.153E-23	P(8) B
13	901.896 882(3)*	2002.90	0.502E-23	P(41) A	48	911.424 656(1)*	1698.65	0.168E-22	P(31) A
14	902.410 271(63)*	2023.33	0.199E-23	P(18) C	49	912.093 125(64)*	1903.69	0.138E-23	P(7) C
15	902.483 580(63)*	2023.02	0.200E-23	P(18) B	50	912.111 365(64)*	1903.64	0.138E-23	P(7) B
16	902.856 8	2690.50	0.147E-24	P(17) G	51	912.359 308(1)*	1672.80	0.185E-22	P(30) A
17	902.864 475(3)*	1968.74	0.579E-23	P(40) A	52	912.951 689(64)*	1897.84	0.121E-23	P(6) C
18	903.308 571(63)*	2008.27	0.203E-23	P(17) C	53	912.966 532(64)*	1897.80	0.121E-23	P(6) B
19	903.375 509(63)*	2007.99	0.203E-23	P(17) B	54	913.290 660(1)*	1647.79	0.202E-22	P(29) A
20	903.828 778(3)*	1935.40	0.664E-23	P(39) A	55	913.806 625(64)*	1892.82	0.102E-23	P(5) C
21	904.203 267(63)*	1994.05	0.205E-23	P(16) C	56	913.818 337(64)*	1892.79	0.102E-23	P(5) B
22	904.264 113(63)*	1993.80	0.205E-23	P(16) B	57	914.218 709(1)*	1623.60	0.220E-22	P(28) A
23	904.789 789(3)*	1902.90	0.759E-23	P(38) A	58	914.657 930(65)*	1888.63	0.813E-24	P(4) C
24	905.094 359(63)*	1980.66	0.205E-23	P(15) C	59	914.666 774(65)*	1888.62	0.813E-24	P(4) B
25	905.149 387(63)*	1980.45	0.205E-23	P(15) B	60	915.143 455(1)*	1600.25	0.238E-22	P(27) A
26	905.747 509(2)*	1871.22	0.863E-23	P(37) A	61	915.505 601(65)*	1885.29	0.588E-24	P(3) C
27	905.981 846(63)*	1968.12	0.203E-23	P(14) C	62	915.511 839(65)*	1885.28	0.588E-24	P(3) B
28	906.031 331(63)*	1967.93	0.203E-23	P(14) B					
29	906.701 936(2)*	1840.38	0.976E-23	P(36) A					
30	906.865 725(63)*	1956.40	0.200E-23	P(13) C					
31	906.909 939(63)*	1956.24	0.200E-23	P(13) B					
32	907.653 071(2)*	1810.37	0.110E-22	P(35) A					
33	907.745 8	2479.56	0.853E-25	R(6) D					
34	907.745 995(64)*	1945.53	0.194E-23	P(12) C					
35	907.785 209(64)*	1945.39	0.195E-23	P(12) B					

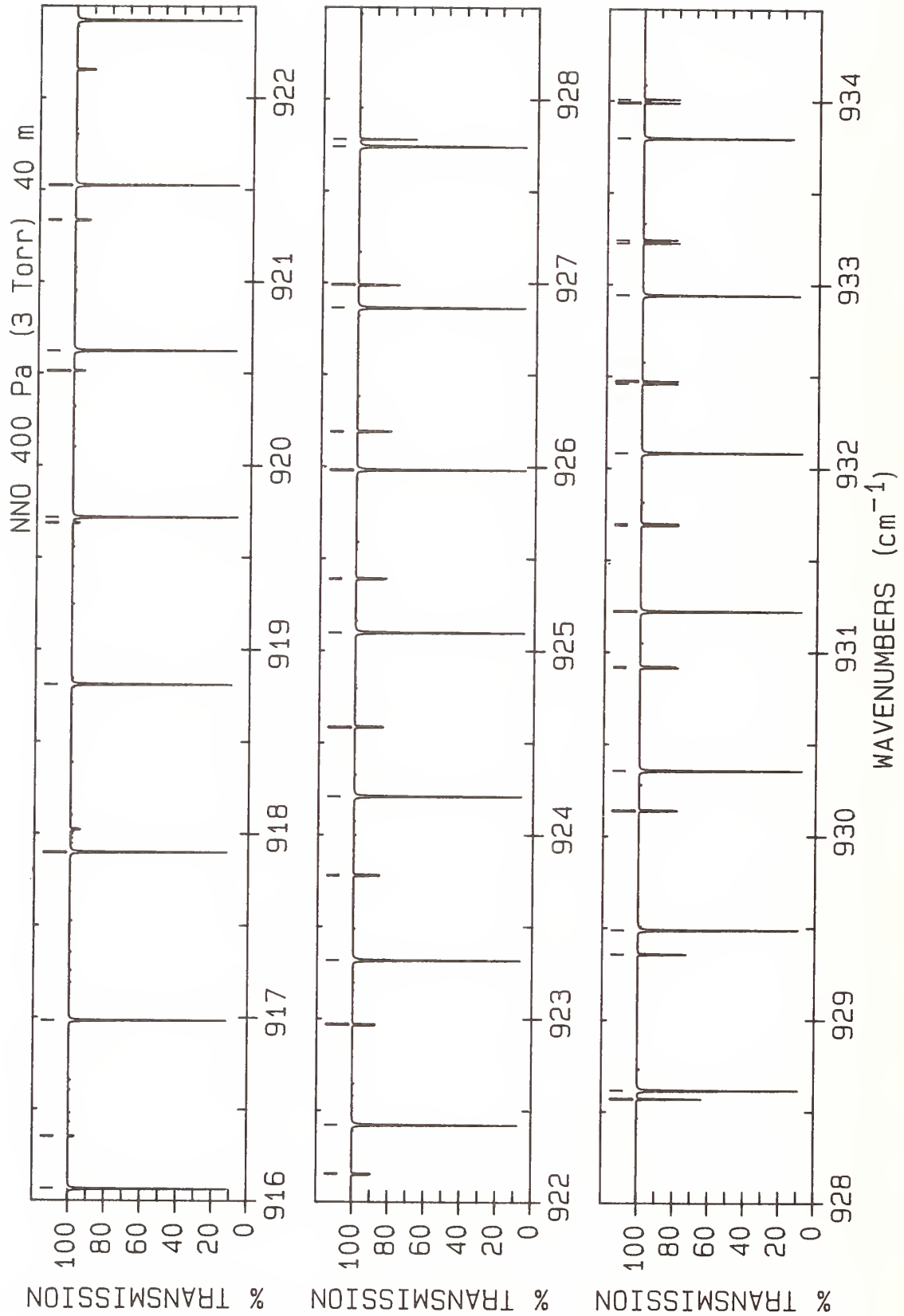

LINE #	WAVENUMBER(unc) (cm ⁻¹)	LOWER STATE (cm ⁻¹)	INTENSITY (cm/molecule)	ASSIGNMENT ROTATION BAND	LINE #	WAVENUMBER(unc) (cm ⁻¹)	LOWER STATE (cm ⁻¹)	INTENSITY (cm/molecule)	ASSIGNMENT ROTATION BAND
1	916.064 894(1)*	1577.73	0.256E-22	P(26)	36	927.741 711(1)*	1360.84	0.372E-22	P(13)
2	916.349 634(65)*	1882.78	0.335E-24	P(2)	37	927.780 425(64)*	1935.37	0.209E-23	R(11)
3	916.353 530(65)*	1882.77	0.335E-24	P(2)	38	927.781 676(63)*	1935.49	0.209E-23	R(11)
4	916.983 025(1)*	1556.05	0.273E-22	P(25)	39	928.570 590(63)*	1945.53	0.216E-23	R(12)
5	917.897 847(1)*	1535.19	0.291E-22	P(24)	40	928.570 965(63)*	1945.39	0.216E-23	R(12)
6	918.809 356(1)*	1515.18	0.307E-22	P(23)	41	928.616 611(1)*	1349.99	0.362E-22	P(12)
7	919.686 461(65)*	1881.10	0.339E-24	R(1)	42	929.355 786(63)*	1956.40	0.221E-23	R(13)
8	919.689 307(65)*	1881.10	0.339E-24	R(1)	43	929.358 056(63)*	1956.24	0.221E-23	R(13)
9	919.717 550(1)*	1495.99	0.323E-22	P(22)	44	929.488 165(1)*	1339.98	0.349E-22	P(11)
10	920.511 214(65)*	1882.77	0.599E-24	R(2)	45	930.137 256(63)*	1968.12	0.224E-23	R(14)
11	920.515 090(65)*	1882.78	0.599E-24	R(2)	46	930.141 695(63)*	1967.93	0.224E-23	R(14)
12	920.622 427(1)*	1477.64	0.338E-22	P(21)	47	930.356 369(1)*	1330.80	0.332E-22	P(10)
13	921.332 567(65)*	1885.28	0.833E-24	R(3)	48	930.914 995(63)*	1980.66	0.225E-23	R(15)
14	921.337 209(65)*	1885.29	0.833E-24	R(3)	49	930.921 875(63)*	1980.45	0.225E-23	R(15)
15	921.523 985(1)*	1460.12	0.350E-22	P(20)	50	931.221 221(1)*	1322.45	0.311E-22	P(9)
16	922.150 515(64)*	1888.62	0.105E-23	R(4)	51	931.688 995(63)*	1994.05	0.224E-23	R(16)
17	922.155 660(64)*	1888.63	0.105E-23	R(4)	52	931.698 591(63)*	1993.80	0.225E-23	R(16)
18	922.422 221(1)*	1443.43	0.361E-22	P(19)	53	932.082 716(1)*	1314.94	0.287E-22	P(8)
19	922.965 054(64)*	1892.79	0.125E-23	R(5)	54	932.459 249(63)*	2008.27	0.222E-23	R(17)
20	922.970 438(64)*	1892.82	0.125E-23	R(5)	55	932.471 838(63)*	2007.99	0.222E-23	R(17)
21	923.317 131(1)*	1427.58	0.370E-22	P(18)	56	932.940 851(1)*	1308.27	0.260E-22	P(7)
22	923.776 178(64)*	1897.80	0.144E-23	R(6)	57	933.225 750(63)*	2023.33	0.218E-23	R(18)
23	923.781 538(64)*	1897.84	0.144E-23	R(6)	58	933.241 610(63)*	2023.02	0.218E-23	R(18)
24	924.208 714(1)*	1412.57	0.376E-22	P(17)	59	933.795 623(1)*	1302.43	0.229E-22	P(6)
25	924.583 884(64)*	1903.64	0.161E-23	R(7)	60	933.988 491(63)*	2039.22	0.213E-23	R(19)
26	924.588 955(64)*	1903.69	0.161E-23	R(7)	61	934.007 901(63)*	2038.88	0.213E-23	R(19)
27	925.096 967(1)*	1398.38	0.380E-22	P(16)					
28	925.388 167(64)*	1910.32	0.176E-23	R(8)					
29	925.392 683(64)*	1910.39	0.176E-23	R(8)					
30	925.981 886(1)*	1385.04	0.380E-22	P(15)					
31	926.189 021(64)*	1917.84	0.189E-23	R(9)					
32	926.192 716(64)*	1917.92	0.189E-23	R(9)					
33	926.863 468(1)*	1372.52	0.378E-22	P(14)					
34	926.986 442(64)*	1926.18	0.200E-23	R(10)					
35	926.989 049(64)*	1926.29	0.200E-23	R(10)					

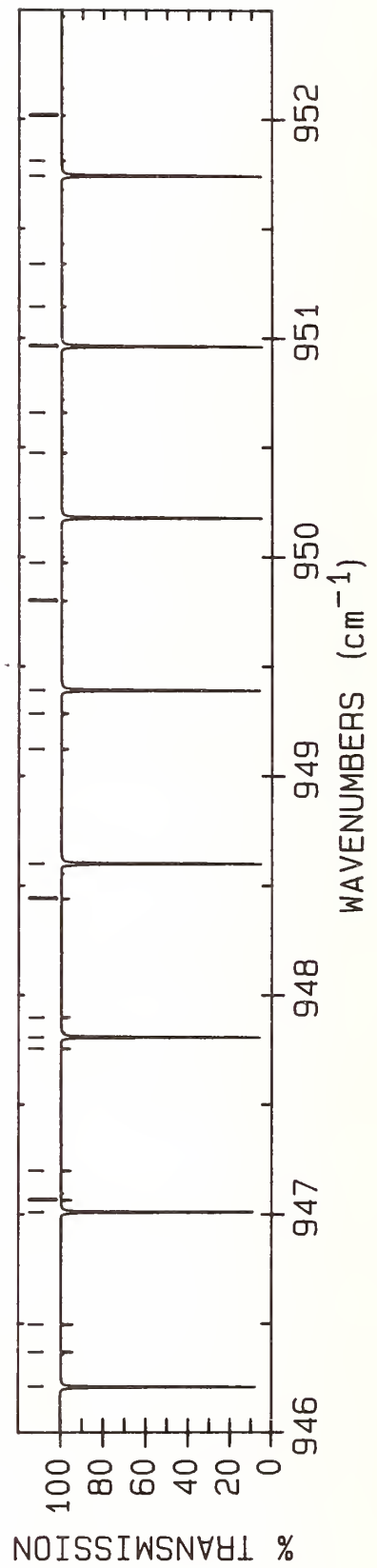
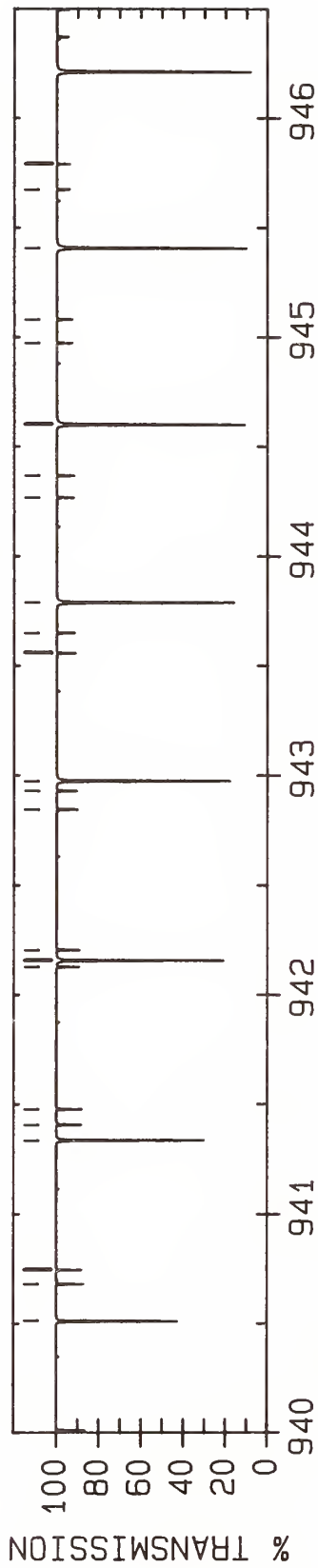
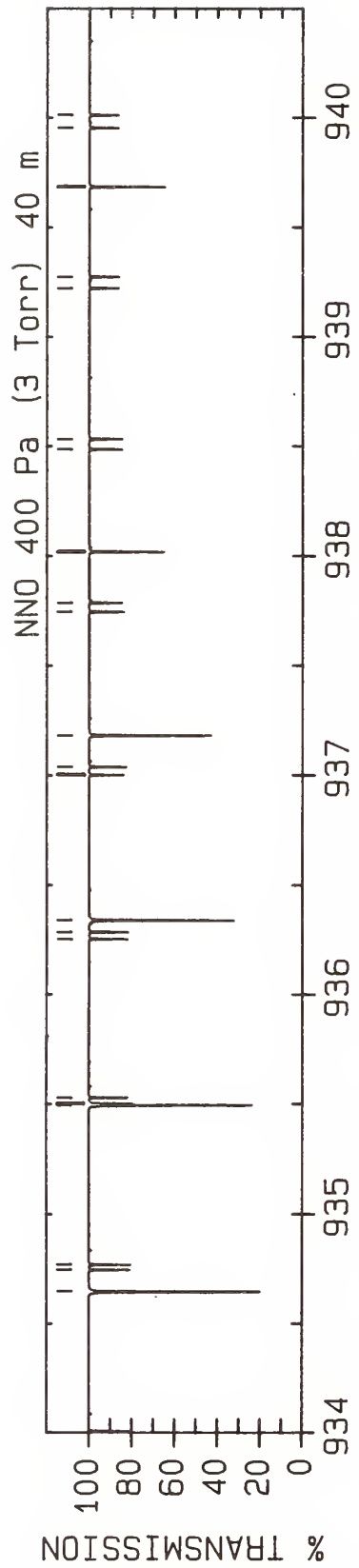

LINE #	WAVENUMBER(unc) (cm ⁻¹)	LOWER STATE (cm ⁻¹)	INTENSITY (cm/molecule)	ASSIGNMENT ROTATION BAND	LINE #	WAVENUMBER(unc) (cm ⁻¹)	LOWER STATE (cm ⁻¹)	INTENSITY (cm/molecule)	ASSIGNMENT ROTATION BAND
1	934.647 027(1)*	1297.42	0.196E-22	P(5) A	36	943.650 320(65)*	2320.91	0.904E-24	R(32) B
2	934.747 464(63)*	2055.95	0.206E-23	R(20) C	37	943.789 097(1)*	1297.42	0.238E-22	R(5) A
3	934.770 707(63)*	2055.57	0.206E-23	R(20) B	38	944.267 401(65)*	2349.46	0.811E-24	R(33) C
4	935.495 060(1)*	1293.25	0.160E-22	P(4) A	39	944.367 259(65)*	2348.44	0.815E-24	R(33) B
5	935.502 661(63)*	2073.52	0.199E-23	R(21) C	40	944.599 778(1)*	1302.43	0.271E-22	R(6) A
6	935.530 022(63)*	2073.10	0.199E-23	R(21) B	41	944.972 710(65)*	2377.89	0.728E-24	R(34) C
7	936.254 074(63)*	2091.92	0.190E-23	R(22) C	42	945.080 625(65)*	2376.80	0.732E-24	R(34) B
8	936.285 839(63)*	2091.46	0.190E-23	R(22) B	43	945.407 037(1)*	1308.27	0.301E-22	R(7) A
9	936.339 719(1)*	1289.91	0.122E-22	P(3) A	44	945.674 111(65)*	2407.14	0.650E-24	R(35) C
10	937.001 695(63)*	2111.16	0.181E-23	R(23) C	45	945.790 409(66)*	2405.99	0.654E-24	R(35) B
11	937.038 152(63)*	2110.65	0.181E-23	R(23) B	46	946.210 868(1)*	1314.94	0.328E-22	R(8) A
12	937.180 998(1)*	1287.41	0.826E-23	P(2) A	47	946.371 594(66)*	2437.23	0.578E-24	R(36) C
13	937.745 516(63)*	2131.23	0.171E-23	R(24) C	48	946.496 606(66)*	2436.02	0.581E-24	R(36) B
14	937.786 957(63)*	2130.68	0.171E-23	R(24) B	49	947.011 269(1)*	1322.45	0.352E-22	R(9) A
15	938.018 894(1)*	1285.74	0.417E-23	P(1) A	50	947.065 148(66)*	2468.16	0.511E-24	R(37) C
16	938.485 528(63)*	2152.14	0.161E-23	R(25) C	51	947.199 208(66)*	2466.88	0.514E-24	R(37) B
17	938.532 246(63)*	2151.54	0.161E-23	R(25) B	52	947.754 760(66)*	2499.92	0.450E-24	R(38) C
18	939.221 723(63)*	2173.88	0.150E-23	R(26) C	53	947.808 233(1)*	1330.80	0.372E-22	R(10) A
19	939.274 014(64)*	2173.24	0.151E-23	R(26) B	54	947.898 207(66)*	2498.57	0.453E-24	R(38) B
20	939.684 522(1)*	1284.90	0.419E-23	R(0) A	55	948.440 419(66)*	2532.51	0.394E-24	R(39) C
21	939.954 090(64)*	2196.46	0.140E-23	R(27) C	56	948.601 755(1)*	1339.98	0.389E-22	R(11) A
22	940.012 255(64)*	2195.77	0.140E-23	R(27) B	57	949.122 112(67)*	2565.94	0.343E-24	R(40) C
23	940.512 245(1)*	1285.74	0.836E-23	R(1) A	58	949.285 367(67)*	2564.44	0.346E-24	R(40) B
24	940.682 622(64)*	2219.87	0.129E-23	R(28) C	59	949.391 832(1)*	1349.99	0.401E-22	R(12) A
25	940.746 961(64)*	2219.13	0.130E-23	R(28) B	60	949.799 826(67)*	2600.20	0.298E-24	R(41) C
26	941.336 569(1)*	1287.41	0.124E-22	R(2) A	61	949.973 513(67)*	2598.62	0.300E-24	R(41) B
27	941.407 308(64)*	2244.12	0.119E-23	R(29) C	62	950.178 457(1)*	1360.84	0.410E-22	R(13) A
28	941.478 128(64)*	2243.33	0.119E-23	R(29) B	63	950.473 550(67)*	2635.29	0.258E-24	R(42) C
29	942.128 139(64)*	2269.20	0.109E-23	R(30) C	64	950.658 025(67)*	2633.64	0.260E-24	R(42) B
30	942.157 488(1)*	1289.91	0.164E-22	R(3) A	65	950.961 625(1)*	1372.52	0.416E-22	R(14) A
31	942.205 747(64)*	2268.36	0.109E-23	R(30) B	66	951.143 269(67)*	2671.21	0.221E-24	R(43) C
32	942.845 105(65)*	2295.12	0.992E-24	R(31) C	67	951.338 897(68)*	2669.48	0.223E-24	R(43) B
33	942.929 814(65)*	2294.22	0.997E-24	R(31) B	68	951.741 332(1)*	1385.04	0.418E-22	R(15) A
34	942.974 999(1)*	1293.25	0.202E-22	R(4) A	69	951.808 971(68)*	2707.97	0.190E-24	R(44) C
35	943.558 196(65)*	2321.88	0.899E-24	R(32) C	70	952.016 118(68)*	2706.16	0.191E-24	R(44) B

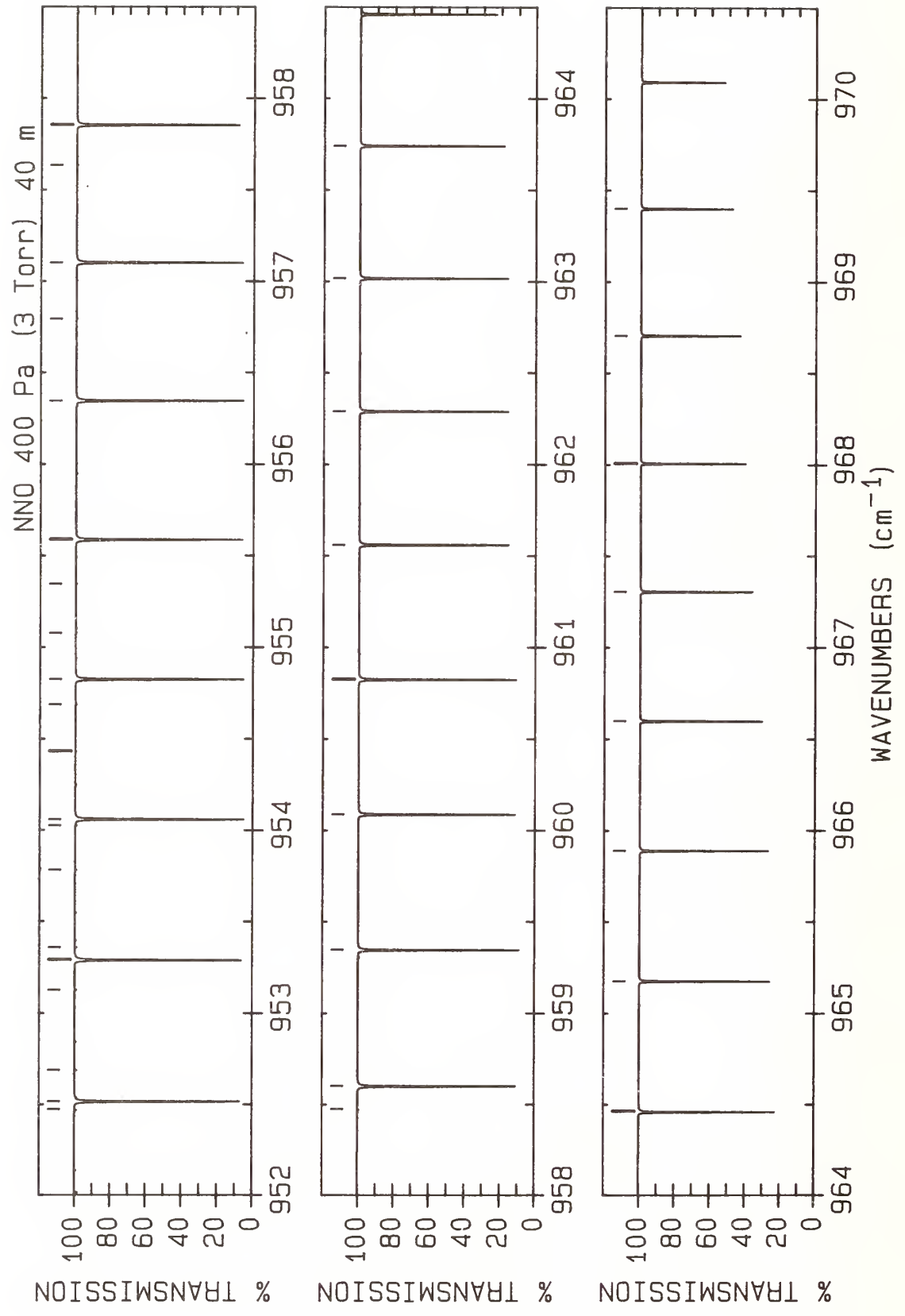

LINE #	WAVENUMBER(unc) (cm ⁻¹)	LOWER STATE (cm ⁻¹)	INTENSITY (cm/molecule)	ASSIGNMENT ROTATION BAND	LINE #	WAVENUMBER(unc) (cm ⁻¹)	LOWER STATE (cm ⁻¹)	INTENSITY (cm/molecule)	ASSIGNMENT ROTATION BAND
1	952.470 641(68)*	2745.56	0.162E-24	R(45) C	21	958.472 423(39)	1329.64	0.912E-25	P(14) T
2	952.517 571(0)*	1398.38	0.416E-22	R(16) A	22	958.602 008(1)*	1535.19	0.317E-22	R(24) A
3	952.689 682(68)*	2743.67	0.163E-24	R(45) B	23	959.346 791(1)*	1556.05	0.298E-22	R(25) A
4	953.128 266(68)*	2783.99	0.137E-24	R(46) C	24	960.088 049(1)*	1577.73	0.279E-22	R(26) A
5	953.290 338(1)*	1412.57	0.412E-22	R(17) A	25	960.825 775(1)*	1600.25	0.259E-22	R(27) A
6	953.359 580(68)*	2782.01	0.138E-24	R(46) B	26	961.559 965(1)*	1623.60	0.240E-22	R(28) A
7	953.781 830(68)*	2823.24	0.116E-24	R(47) C	27	962.290 609(1)*	1647.79	0.221E-22	R(29) A
8	954.025 802(69)*	2821.18	0.117E-24	R(47) B	28	963.017 704(1)*	1672.80	0.202E-22	R(30) A
9	954.059 627(1)*	1427.58	0.404E-22	R(18) A	29	963.741 240(1)*	1698.65	0.184E-22	R(31) A
10	954.431 320(68)*	2863.33	0.973E-25	R(48) C	30	964.461 212(1)*	1725.33	0.167E-22	R(32) A
11	954.688 341(69)*	2861.18	0.983E-25	R(48) B	31	965.177 613(1)*	1752.85	0.151E-22	R(33) A
12	954.825 433(1)*	1443.43	0.394E-22	R(19) A	32	965.890 435(1)*	1781.19	0.135E-22	R(34) A
13	955.076 720(69)*	2904.25	0.814E-25	R(49) C	33	966.599 671(1)*	1810.37	0.121E-22	R(35) A
14	955.347 187(69)*	2902.01	0.823E-25	R(49) B	34	967.305 314(1)*	1840.38	0.107E-22	R(36) A
15	955.587 749(1)*	1460.12	0.382E-22	R(20) A	35	968.007 357(1)*	1871.22	0.950E-23	R(37) A
16	956.346 571(1)*	1477.64	0.368E-22	R(21) A	36	968.705 791(1)*	1902.90	0.837E-23	R(38) A
17	956.794 457(36)	1354.07	0.924E-25	P(16) T	37	969.400 609(1)*	1935.40	0.733E-23	R(39) A
18	957.101 892(1)*	1495.99	0.352E-22	R(22) A					
19	957.635 185(37)	1341.46	0.922E-25	P(15) T					
20	957.853 706(1)*	1515.18	0.335E-22	R(23) A					

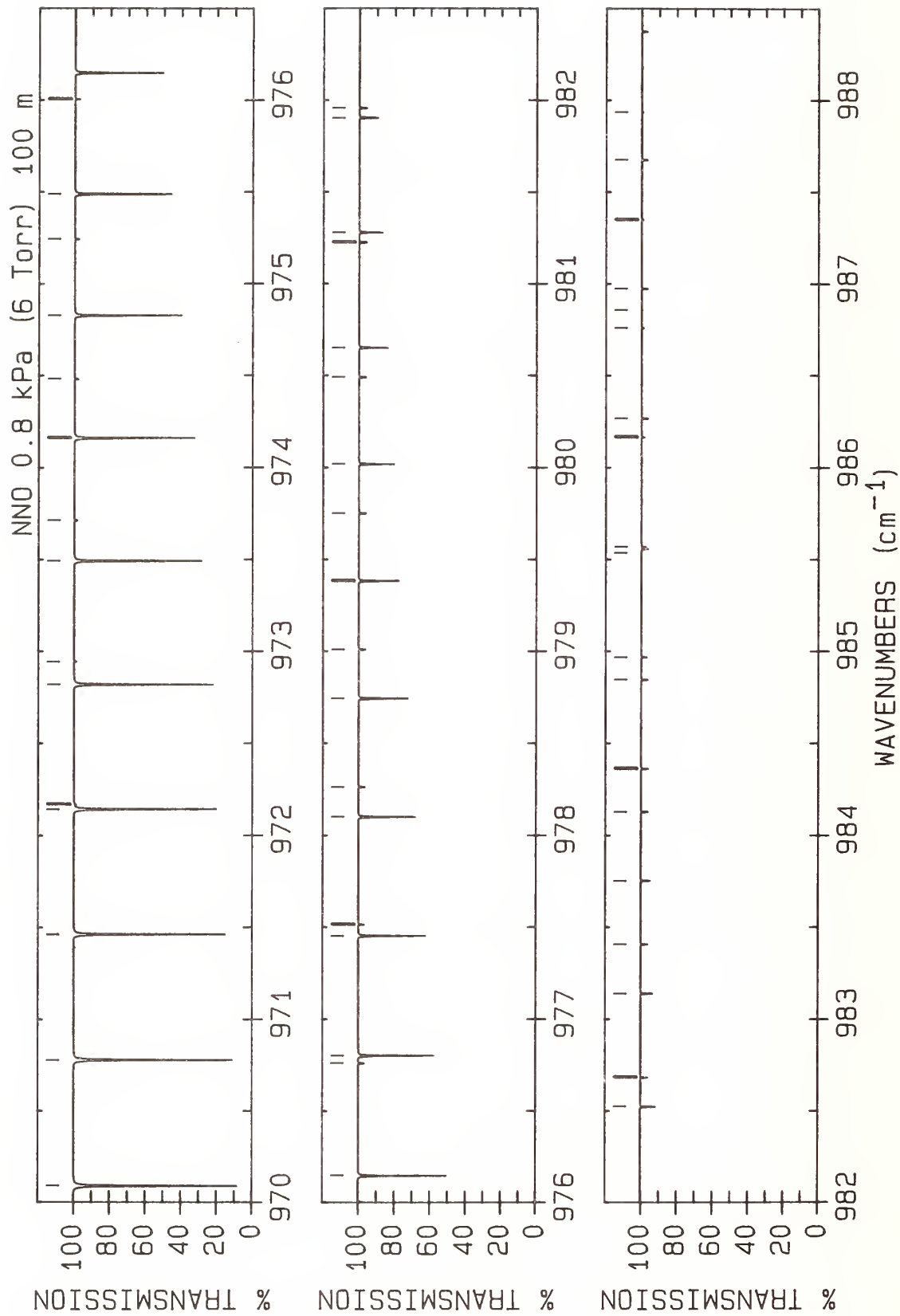

LINE #	WAVENUMBER(unc) (cm ⁻¹)	LOWER STATE (cm ⁻¹)	INTENSITY (cm/molecule)	ASSIGNMENT ROTATION BAND	LINE #	WAVENUMBER(unc) (cm ⁻¹)	LOWER STATE (cm ⁻¹)	INTENSITY (cm/molecule)	ASSIGNMENT ROTATION BAND
1	970.091 803(1)*	1968.74	0.640E-23	R(40) A	31	981.279 009(8)*	2662.47	0.314E-24	R(57) A
2	970.779 364(2)*	2002.90	0.555E-23	R(41) A	32	981.903 393(9)*	2710.73	0.253E-24	R(58) A
3	971.463 285(2)*	2037.90	0.480E-23	R(42) A	33	981.956 185(36)	1341.46	0.101E-24	R(15) T
4	972.143 557(2)*	2073.73	0.413E-23	R(43) A	34	982.523 963(10)*	2759.83	0.203E-24	R(59) A
5	972.170 138(52)	1249.25	0.293E-25	R(2) T	35	982.683 887(35)	1354.07	0.101E-24	R(16) T
6	972.820 171(2)*	2110.39	0.354E-23	R(44) A	36	983.140 707(11)*	2809.75	0.162E-24	R(60) A
7	972.944 250(51)	1251.61	0.387E-25	R(3) T	37	983.407 976(34)	1367.47	0.100E-24	R(17) T
8	973.493 118(3)*	2147.88	0.302E-23	R(45) A	38	983.753 612(12)*	2860.50	0.129E-24	R(61) A
9	973.714 825(50)	1254.77	0.476E-25	R(4) T	39	984.128 443(34)	1381.65	0.988E-25	R(18) T
10	974.162 391(3)*	2186.20	0.256E-23	R(46) A	40	984.362 666(12)*	2912.08	0.102E-24	R(62) A
11	974.481 856(49)	1258.71	0.561E-25	R(5) T	41	984.845 281(33)	1396.63	0.968E-25	R(19) T
12	974.827 978(3)*	2225.35	0.216E-23	R(47) A	42	984.967 853(13)*	2964.48	0.802E-25	R(63) A
13	975.245 341(48)	1263.44	0.641E-25	R(6) T	43	985.535 226(82)*	2910.90	0.101E-25	P(64) M
14	975.489 871(4)*	2265.33	0.182E-23	R(48) A	44	985.569 162(14)*	3017.71	0.629E-25	R(64) A
15	976.005 274(47)	1268.95	0.713E-25	R(7) T	45	986.166 576(15)*	3071.76	0.492E-25	R(65) A
16	976.148 061(4)*	2306.14	0.152E-23	R(49) A	46	986.268 037(34)	1428.93	0.911E-25	R(21) T
17	976.761 649(46)	1275.26	0.779E-25	R(8) T	47	986.760 082(16)*	3126.64	0.383E-25	R(66) A
18	976.802 536(4)*	2347.78	0.127E-23	R(50) A	48	986.857 945(81)*	2857.40	0.129E-25	P(63) M
19	977.453 289(5)*	2390.25	0.105E-23	R(51) A	49	986.973 940(34)	1446.27	0.876E-25	R(22) T
20	977.514 461(44)	1282.35	0.837E-25	R(9) T	50	987.349 665(17)*	3182.35	0.296E-25	R(67) A
21	978.100 307(5)*	2433.55	0.871E-24	R(52) A	51	987.676 179(35)	1464.39	0.838E-25	R(23) T
22	978.263 705(43)	1290.23	0.887E-25	R(10) T	52	987.935 309(18)*	3238.88	0.229E-25	R(68) A
23	978.743 580(6)*	2477.68	0.717E-24	R(53) A					
24	979.009 374(41)	1298.90	0.928E-25	R(11) T					
25	979.383 099(6)*	2522.63	0.587E-24	R(54) A					
26	979.751 464(40)	1308.36	0.961E-25	R(12) T					
27	980.018 850(7)*	2568.42	0.479E-24	R(55) A					
28	980.489 966(39)	1318.61	0.985E-25	R(13) T					
29	980.650 825(8)*	2615.03	0.389E-24	R(56) A					
30	981.224 875(37)	1329.64	0.100E-24	R(14) T					

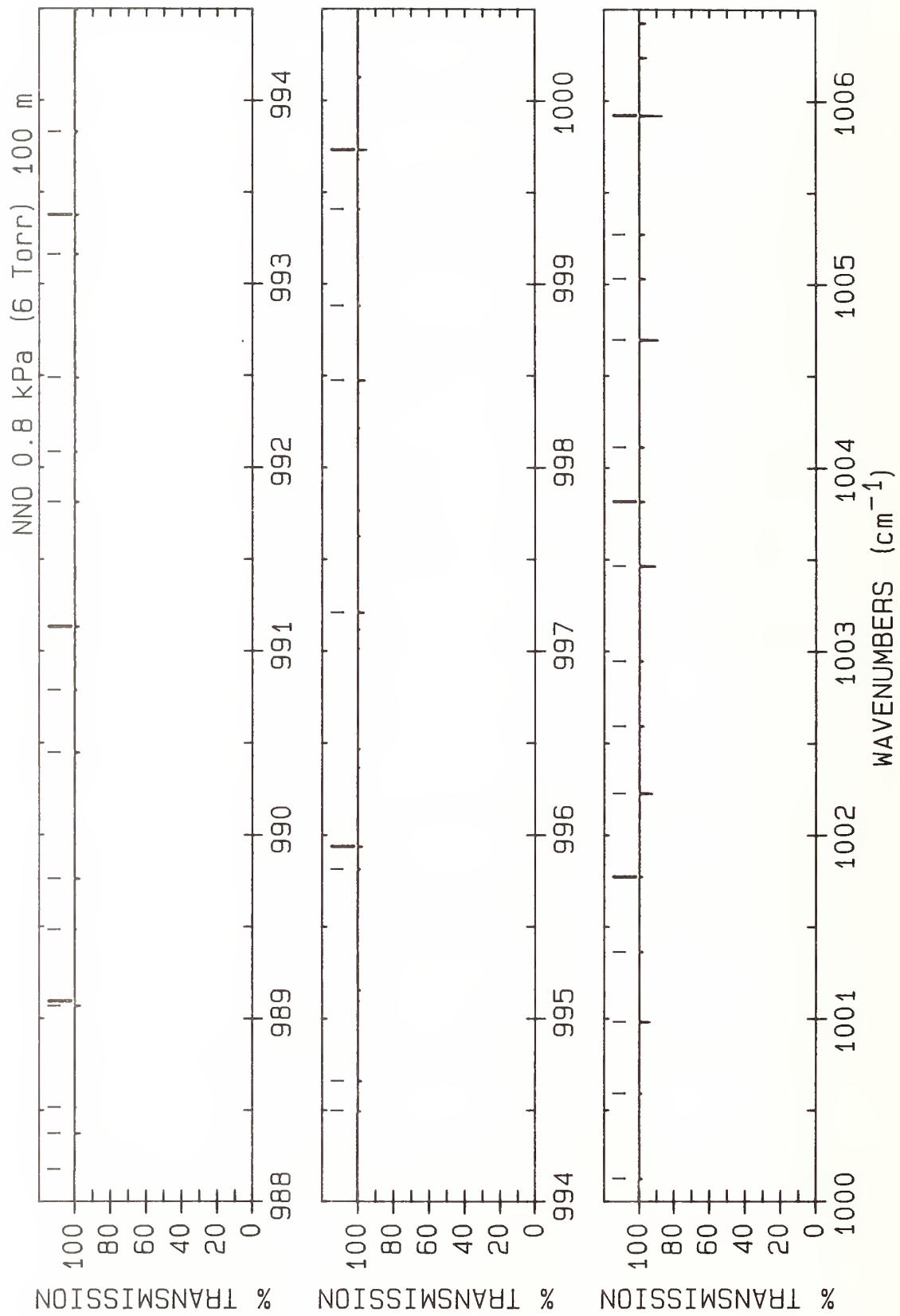

LINE #	WAVENUMBER(unc) (cm ⁻¹)	LOWER STATE (cm ⁻¹)	INTENSITY (cm/molecule)	ASSIGNMENT ROTATION BAND	LINE #	WAVENUMBER(unc) (cm ⁻¹)	LOWER STATE (cm ⁻¹)	INTENSITY (cm/molecule)	ASSIGNMENT ROTATION BAND
1	988.174 34(8)*	2804.72	0.165E-25	P(62)	21	997.209 20(7)*	2459.21	0.810E-25	P(55)
2	988.374 75(3)	1483.30	0.797E-25	R(24)	22	998.473 73(7)*	2413.18	0.998E-25	P(54)
3	988.517 00(2)*	3296.24	0.176E-25	R(69)	23	998.880 40(9)	2738.23	0.379E-25	P(48)
4	989.069 64(4)	1502.99	0.754E-25	R(25)	24	999.406 91(9)	2775.80	0.323E-25	P(49)
5	989.094 72(2)*	3354.41	0.134E-25	R(70)	25	999.731 61(7)*	2367.97	0.122E-24	P(53)
6	989.484 38(8)*	2752.87	0.210E-25	P(61)	26	1000.125 95(9)	2697.91	0.452E-25	P(47)
7	989.760 83(4)	1523.48	0.709E-25	R(26)	27	1000.593 35(9)	2734.77	0.387E-25	P(48)
8	990.448 33(4)	1544.75	0.663E-25	R(27)	28	1000.982 78(7)*	2323.60	0.150E-24	P(52)
9	990.788 04(8)*	2701.85	0.266E-25	P(60)	29	1001.363 73(9)	2658.42	0.537E-25	P(46)
10	991.132 12(4)	1566.80	0.618E-25	R(28)	30	1001.773 13(9)	2694.59	0.461E-25	P(47)
11	991.812 19(4)	1589.65	0.572E-25	R(29)	31	1002.227 21(7)*	2280.07	0.182E-24	P(51)
12	992.085 27(8)*	2651.66	0.335E-25	P(59)	32	1002.593 70(9)	2619.76	0.635E-25	P(45)
13	992.488 53(4)	1613.28	0.527E-25	R(30)	33	1002.946 21(9)	2655.23	0.547E-25	P(46)
14	993.161 12(4)	1637.70	0.484E-25	R(31)	34	1003.464 84(7)*	2237.36	0.221E-24	P(50)
15	993.376 04(8)*	2602.30	0.421E-25	P(58)	35	1003.815 80(9)	2581.95	0.748E-25	P(44)
16	993.829 97(4)	1662.90	0.442E-25	R(32)	36	1004.112 56(9)	2616.71	0.647E-25	P(45)
17	994.495 05(4)	1688.89	0.401E-25	R(33)	37	1004.695 63(7)*	2195.49	0.266E-24	P(49)
18	994.660 31(7)*	2553.77	0.526E-25	P(57)	38	1005.029 99(9)	2544.97	0.876E-25	P(43)
19	995.813 86(4)	1743.23	0.327E-25	R(35)	39	1005.272 16(9)	2579.02	0.761E-25	P(44)
20	995.938 04(7)*	2506.08	0.654E-25	P(56)	40	1005.919 54(7)*	2154.45	0.319E-24	P(48)

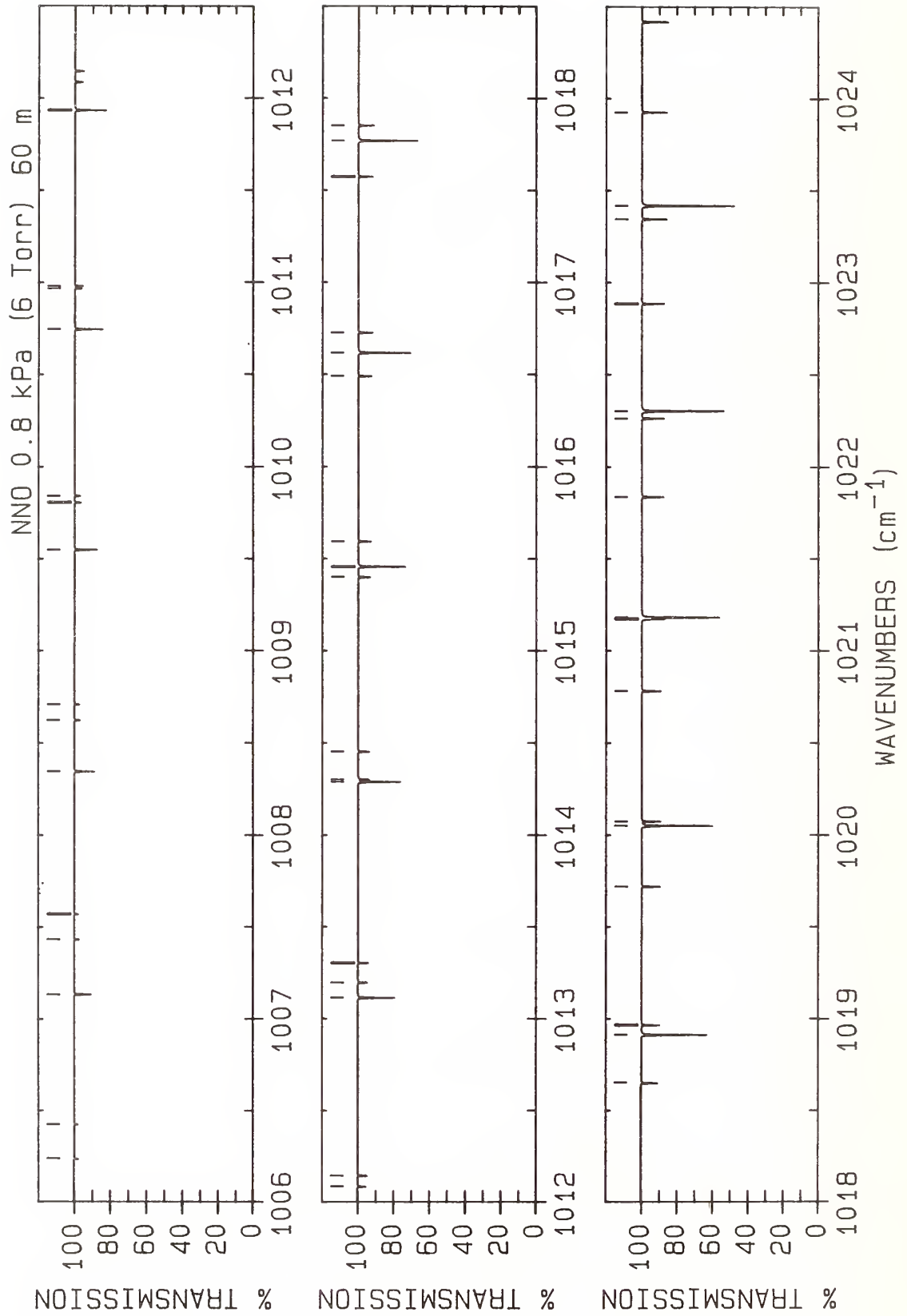

LINE #	WAVENUMBER(unc) (cm ⁻¹)	LOWER STATE (cm ⁻¹)	INTENSITY (cm/molecule)	ASSIGNMENT ROTATION BAND	LINE #	WAVENUMBER(unc) (cm ⁻¹)	LOWER STATE (cm ⁻¹)	INTENSITY (cm/molecule)	ASSIGNMENT ROTATION BAND
1	1006.236 22(9)	2508.82	0.102E-24	P(42) O	26	1015.594 03(8)	2249.84	0.295E-24	P(34) O
2	1006.424 98(9)	2542.17	0.891E-25	P(43) N	27	1016.490 67(8)	2248.07	0.298E-24	P(34) N
3	1007.136 51(7)*	2114.24	0.381E-24	P(47) M	28	1016.616 65(7)*	1822.61	0.133E-23	P(39) M
4	1007.434 44(9)	2473.52	0.119E-24	P(41) O	29	1016.726 62(8)	2221.24	0.329E-24	P(33) O
5	1007.571 00(9)	2506.15	0.104E-24	P(42) N	30	1017.574 16(8)	2219.57	0.332E-24	P(33) N
6	1008.346 50(7)*	2074.87	0.453E-24	P(46) M	31	1017.768 95(7)*	1789.92	0.153E-23	P(38) M
7	1008.624 60(9)	2439.05	0.137E-24	P(40) O	32	1017.850 83(8)	2193.48	0.366E-24	P(32) O
8	1008.710 17(9)	2470.97	0.120E-24	P(41) N	33	1018.650 58(8)	2191.91	0.369E-24	P(32) N
9	1009.549 45(7)*	2036.33	0.536E-24	P(45) M	34	1018.913 80(7)*	1758.06	0.174E-23	P(37) M
10	1009.806 67(9)	2405.42	0.158E-24	P(39) O	35	1018.966 62(8)	2166.56	0.404E-24	P(31) O
11	1009.842 49(9)	2436.62	0.139E-24	P(40) N	36	1019.719 90(8)	2165.09	0.408E-24	P(31) N
12	1010.745 32(7)*	1998.62	0.631E-24	P(44) M	37	1020.051 16(7)*	1727.03	0.197E-23	P(36) M
13	1010.967 90(9)	2403.11	0.160E-24	P(39) N	38	1020.073 95(8)	2140.48	0.445E-24	P(30) O
14	1010.980 59(9)	2372.63	0.180E-24	P(38) O	39	1020.782 08(8)	2139.10	0.448E-24	P(30) N
15	1011.934 06(7)*	1961.75	0.740E-24	P(43) M	40	1021.172 79(8)	2115.24	0.487E-24	P(29) O
16	1012.086 41(9)	2370.43	0.183E-24	P(38) N	41	1021.180 97(7)*	1696.84	0.223E-23	P(35) M
17	1012.146 33(9)	2340.67	0.205E-24	P(37) O	42	1021.837 11(8)	2113.94	0.490E-24	P(29) N
18	1013.115 61(7)*	1925.71	0.864E-24	P(42) M	43	1022.263 11(8)	2090.84	0.530E-24	P(28) O
19	1013.197 96(9)	2338.59	0.208E-24	P(37) N	44	1022.303 18(7)*	1667.49	0.250E-23	P(34) M
20	1013.303 85(8)	2309.55	0.233E-24	P(36) O	45	1022.884 96(8)	2089.63	0.533E-24	P(28) N
21	1014.289 93(7)*	1890.51	0.100E-23	P(41) M	46	1023.344 87(8)	2067.28	0.573E-24	P(27) O
22	1014.302 54(8)	2307.58	0.235E-24	P(36) N	47	1023.417 74(7)*	1638.97	0.279E-23	P(33) M
23	1014.453 09(8)	2279.28	0.263E-24	P(35) O	48	1023.925 61(8)	2066.15	0.577E-24	P(27) N
24	1015.400 12(8)	2277.41	0.265E-24	P(35) N					
25	1015.456 96(7)*	1856.14	0.116E-23	P(40) M					

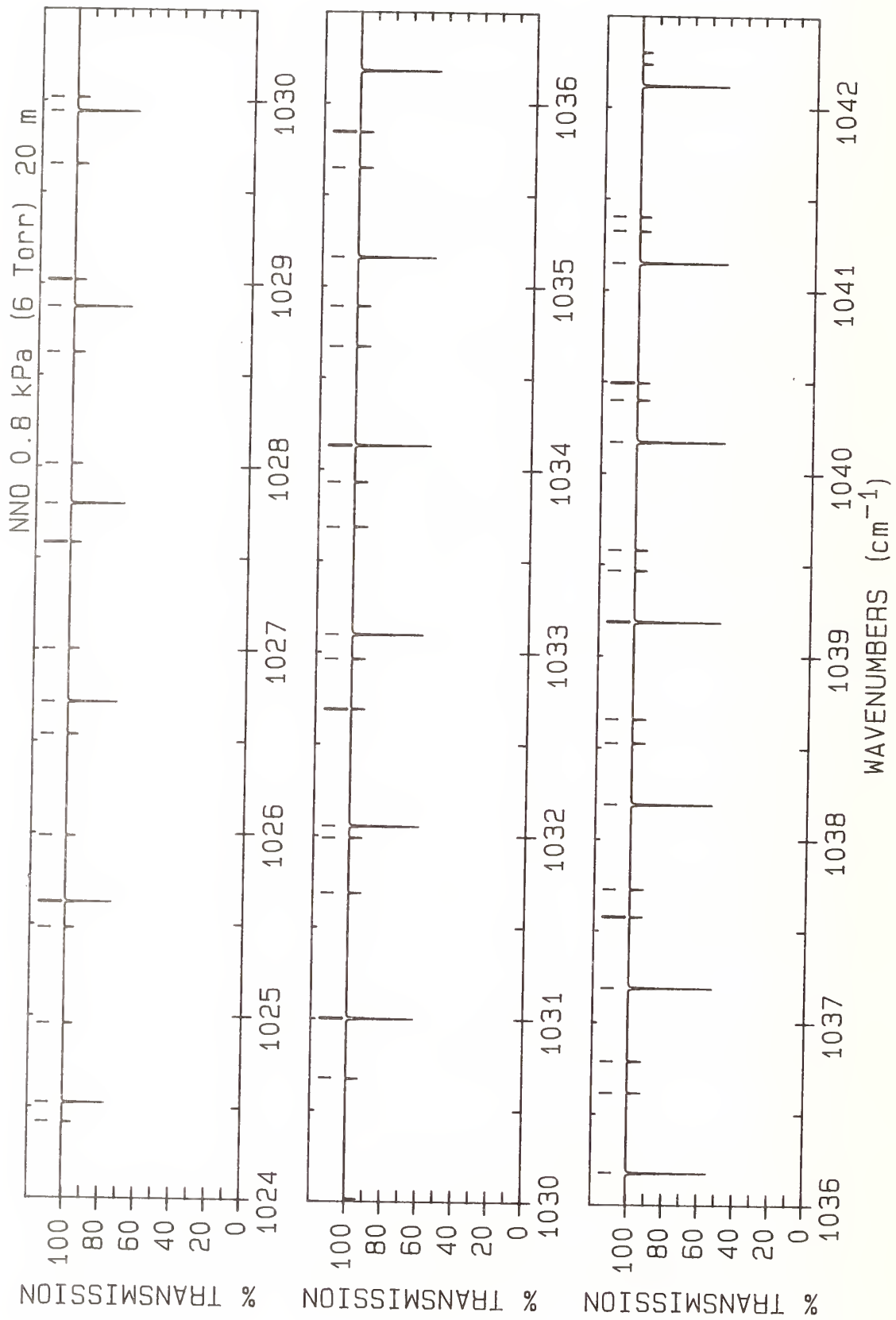

LINE #	WAVENUMBER(unc) (cm ⁻¹)	LOWER STATE (cm ⁻¹)	INTENSITY (cm/molecule)	ASSIGNMENT ROTATION BAND	LINE #	WAVENUMBER(unc) (cm ⁻¹)	LOWER STATE (cm ⁻¹)	INTENSITY (cm/molecule)	ASSIGNMENT ROTATION BAND
1	1024.418 04(8)	2044.56	0.617E-24	P(26) O	31	1034.671 32(8)	1863.58	0.923E-24	P(16) O
2	1024.524 60(7)*	1611.29	0.310E-23	P(32) M	32	1034.890 91(8)	1863.18	0.925E-24	P(16) N
3	1024.959 02(8)	2043.51	0.621E-24	P(26) N	33	1035.158 93(7)*	1380.55	0.665E-23	P(22) M
4	1025.482 60(8)	2022.67	0.661E-24	P(25) O	34	1035.648 26(8)	1850.11	0.925E-24	P(15) O
5	1025.623 70(7)*	1584.45	0.343E-23	P(31) M	35	1035.843 43(8)	1849.75	0.926E-24	P(15) N
6	1025.985 19(8)	2021.71	0.664E-24	P(25) N	36	1036.177 94(7)*	1362.08	0.696E-23	P(21) M
7	1026.538 51(8)	2001.63	0.704E-24	P(24) O	37	1036.616 30(8)	1837.48	0.918E-24	P(14) O
8	1026.715 01(7)*	1558.45	0.378E-23	P(30) M	38	1036.788 47(8)	1837.17	0.919E-24	P(14) N
9	1027.004 09(8)	2000.74	0.707E-24	P(24) N	39	1037.188 70(7)*	1344.45	0.723E-23	P(20) M
10	1027.585 75(8)	1981.43	0.744E-24	P(23) O	40	1037.575 45(8)	1825.69	0.903E-24	P(13) O
11	1027.798 47(7)*	1533.28	0.413E-23	P(29) M	41	1037.726 04(8)	1825.42	0.904E-24	P(13) N
12	1028.015 69(8)	1980.61	0.748E-24	P(23) N	42	1038.191 17(7)*	1327.67	0.746E-23	P(19) M
13	1028.624 28(8)	1962.08	0.783E-24	P(22) O	43	1038.525 68(8)	1814.75	0.879E-24	P(12) O
14	1028.874 03(7)*	1508.94	0.450E-23	P(28) M	44	1038.656 10(8)	1814.52	0.880E-24	P(12) N
15	1029.019 98(8)	1961.32	0.786E-24	P(22) N	45	1039.185 32(7)*	1311.72	0.764E-23	P(18) M
16	1029.654 08(8)	1943.56	0.819E-24	P(21) O	46	1039.466 96(8)	1804.64	0.846E-24	P(11) O
17	1029.941 64(7)*	1485.45	0.487E-23	P(27) M	47	1039.578 66(8)	1804.45	0.847E-24	P(11) N
18	1030.016 92(8)	1942.87	0.822E-24	P(21) N	48	1040.171 11(7)*	1296.61	0.778E-23	P(17) M
19	1030.675 13(8)	1925.88	0.850E-24	P(20) O	49	1040.399 30(8)	1795.38	0.804E-24	P(10) O
20	1031.001 26(7)*	1462.80	0.524E-23	P(26) M	50	1040.493 68(8)	1795.22	0.804E-24	P(10) N
21	1031.006 51(8)	1925.25	0.853E-24	P(20) N	51	1041.148 52(7)*	1282.33	0.785E-23	P(16) M
22	1031.687 41(8)	1909.04	0.877E-24	P(19) O	52	1041.322 66(8)	1786.96	0.752E-24	P(9) O
23	1031.988 73(8)	1908.48	0.880E-24	P(19) N	53	1041.401 17(8)	1786.83	0.753E-24	P(9) N
24	1032.052 84(7)*	1440.98	0.561E-23	P(25) M					
25	1032.690 88(8)	1893.05	0.899E-24	P(18) O					
26	1032.963 54(8)	1892.54	0.901E-24	P(18) N					
27	1033.096 34(7)*	1420.00	0.597E-23	P(24) M					
28	1033.685 52(8)	1877.89	0.915E-24	P(17) O					
29	1033.930 94(8)	1877.44	0.917E-24	P(17) N					
30	1034.131 72(7)*	1399.85	0.632E-23	P(23) M					

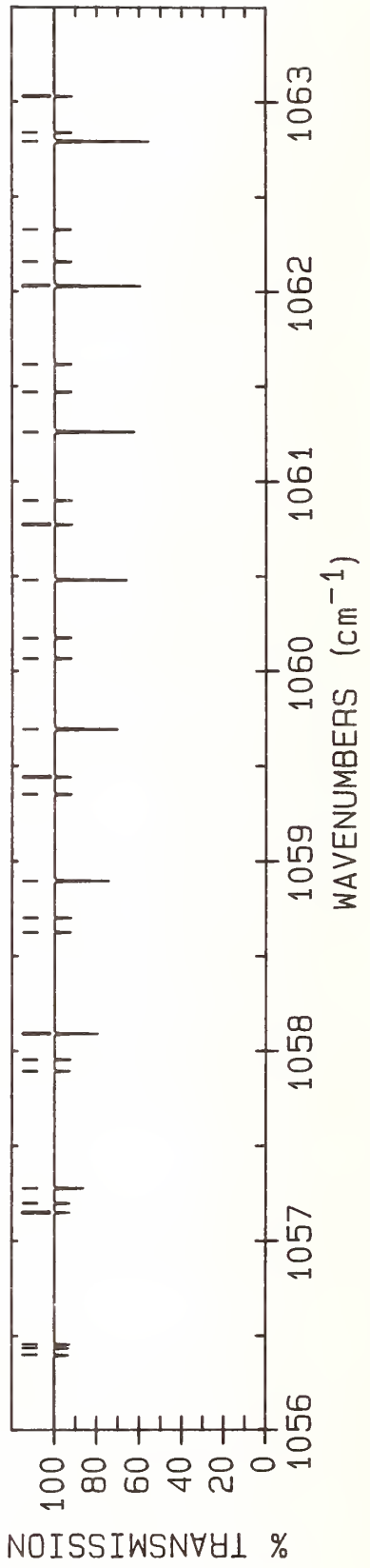
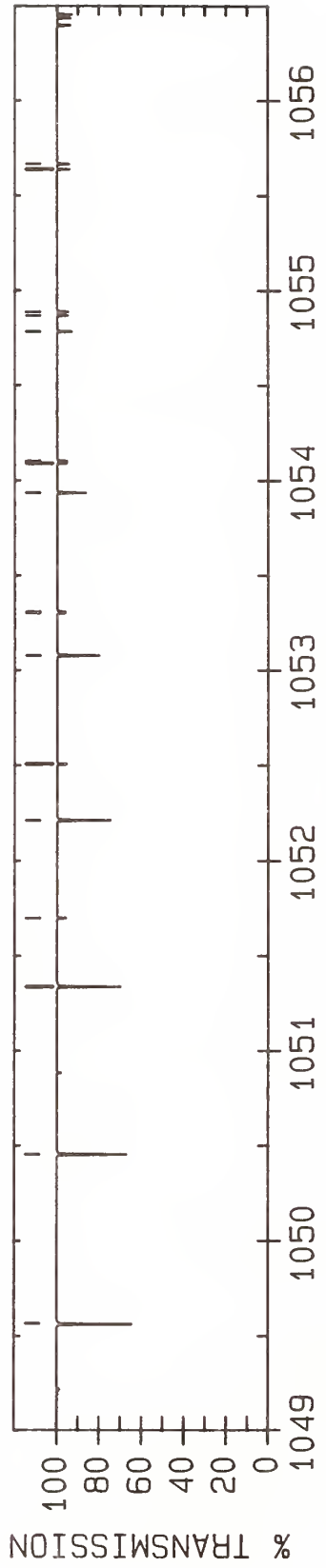
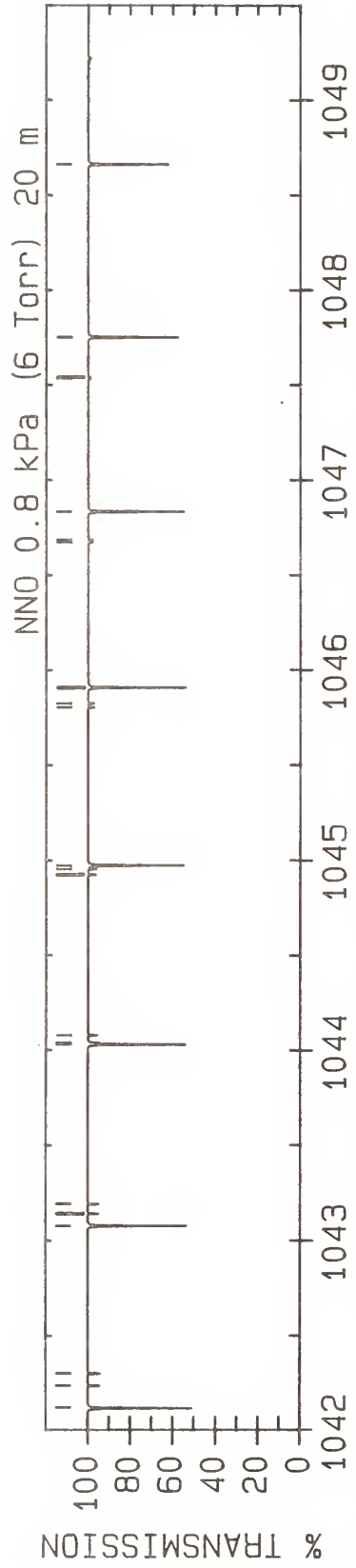

LINE #	WAVENUMBER(unc) (cm ⁻¹)	LOWER STATE (cm ⁻¹)	INTENSITY (cm/molecule)	ASSIGNMENT ROTATION BAND	LINE #	WAVENUMBER(unc) (cm ⁻¹)	LOWER STATE (cm ⁻¹)	INTENSITY (cm/molecule)	ASSIGNMENT ROTATION BAND
1	1042.117 50(7)*	1268.90	0.787E-23	P(15) M	36	1054.102 20(8)	1761.65	0.565E-24	R(5) N
2	1042.237 05(8)	1779.38	0.692E-24	P(8) O	37	1054.784 46(7)*	1168.97	0.864E-24	P(1) M
3	1042.301 10(8)	1779.27	0.693E-24	P(8) N	38	1054.868 67(8)	1766.75	0.649E-24	R(6) O
4	1043.078 03(7)*	1256.31	0.781E-23	P(14) M	39	1054.887 92(8)	1766.69	0.649E-24	R(6) N
5	1043.142 44(8)	1772.64	0.623E-24	P(7) O	40	1055.638 27(8)	1772.64	0.725E-24	R(7) O
6	1043.193 47(8)	1772.56	0.624E-24	P(7) N	41	1055.665 99(8)	1772.56	0.725E-24	R(7) N
7	1044.030 07(7)*	1244.55	0.769E-23	P(13) M	42	1056.398 79(8)	1779.38	0.792E-24	R(8) O
8	1044.038 82(8)	1766.75	0.546E-24	P(6) O	43	1056.436 43(8)	1779.27	0.793E-24	R(8) N
9	1044.078 27(8)	1766.69	0.546E-24	P(6) N	44	1056.455 42(7)*	1168.13	0.869E-24	R(0) M
10	1044.926 19(8)	1761.70	0.461E-24	P(5) O	45	1057.150 25(8)	1786.96	0.851E-24	R(9) O
11	1044.955 48(8)	1761.65	0.461E-24	P(5) N	46	1057.199 24(8)	1786.83	0.852E-24	R(9) N
12	1044.973 60(7)*	1233.63	0.749E-23	P(12) M	47	1057.277 81(7)*	1168.97	0.173E-23	R(1) M
13	1045.804 54(8)	1757.49	0.368E-24	P(4) O	48	1057.892 65(8)	1795.38	0.901E-24	R(10) O
14	1045.825 10(8)	1757.46	0.368E-24	P(4) N	49	1057.954 40(8)	1795.22	0.902E-24	R(10) N
15	1045.908 60(7)*	1223.56	0.722E-23	P(11) M	50	1058.091 48(7)*	1170.65	0.258E-23	R(2) M
16	1046.673 84(8)	1754.12	0.266E-24	P(3) O	51	1058.625 98(8)	1804.64	0.941E-24	R(11) O
17	1046.687 11(8)	1754.10	0.266E-24	P(3) N	52	1058.701 95(8)	1804.45	0.942E-24	R(11) N
18	1046.835 04(7)*	1214.32	0.687E-23	P(10) M	53	1058.896 42(7)*	1173.17	0.340E-23	R(3) M
19	1047.534 11(8)	1751.59	0.152E-24	P(2) O	54	1059.350 27(8)	1814.75	0.973E-24	R(12) O
20	1047.541 52(8)	1751.58	0.152E-24	P(2) N	55	1059.441 86(8)	1814.52	0.974E-24	R(12) N
21	1047.752 89(7)*	1205.92	0.645E-23	P(9) M	56	1059.692 63(7)*	1176.53	0.418E-23	R(4) M
22	1048.662 13(7)*	1198.37	0.595E-23	P(8) M	57	1060.065 51(8)	1825.69	0.995E-24	R(13) O
23	1049.562 75(7)*	1191.65	0.539E-23	P(7) M	58	1060.174 16(8)	1825.42	0.996E-24	R(13) N
24	1050.454 73(7)*	1185.77	0.476E-23	P(6) M	59	1060.480 12(7)*	1180.73	0.492E-23	R(5) M
25	1051.338 05(7)*	1180.73	0.406E-23	P(5) M	60	1060.771 72(8)	1837.48	0.101E-23	R(14) O
26	1051.699 20(8)	1751.58	0.271E-24	R(2) N	61	1060.898 84(8)	1837.17	0.101E-23	R(14) N
27	1051.699 56(8)	1751.59	0.271E-24	R(2) O	62	1061.258 88(7)*	1185.77	0.561E-23	R(6) M
28	1052.212 69(7)*	1176.53	0.332E-23	P(4) M	63	1061.468 89(8)	1850.11	0.101E-23	R(15) O
29	1052.505 45(8)	1754.12	0.376E-24	R(3) O	64	1061.615 91(8)	1849.75	0.101E-23	R(15) N
30	1052.507 84(8)	1754.10	0.376E-24	R(3) N	65	1062.028 94(7)*	1191.65	0.623E-23	R(7) M
31	1053.078 65(7)*	1173.17	0.253E-23	P(3) M	66	1062.157 05(8)	1863.58	0.101E-23	R(16) O
32	1053.302 27(8)	1757.49	0.474E-24	R(4) O	67	1062.325 39(8)	1863.18	0.101E-23	R(16) N
33	1053.308 84(8)	1757.46	0.475E-24	R(4) N	68	1062.790 28(7)*	1198.37	0.679E-23	R(8) M
34	1053.935 91(7)*	1170.65	0.171E-23	P(2) M	69	1062.836 20(8)	1877.89	0.997E-24	R(17) O
35	1054.090 01(8)	1761.70	0.565E-24	R(5) O	70	1063.027 27(8)	1877.44	0.999E-24	R(17) N

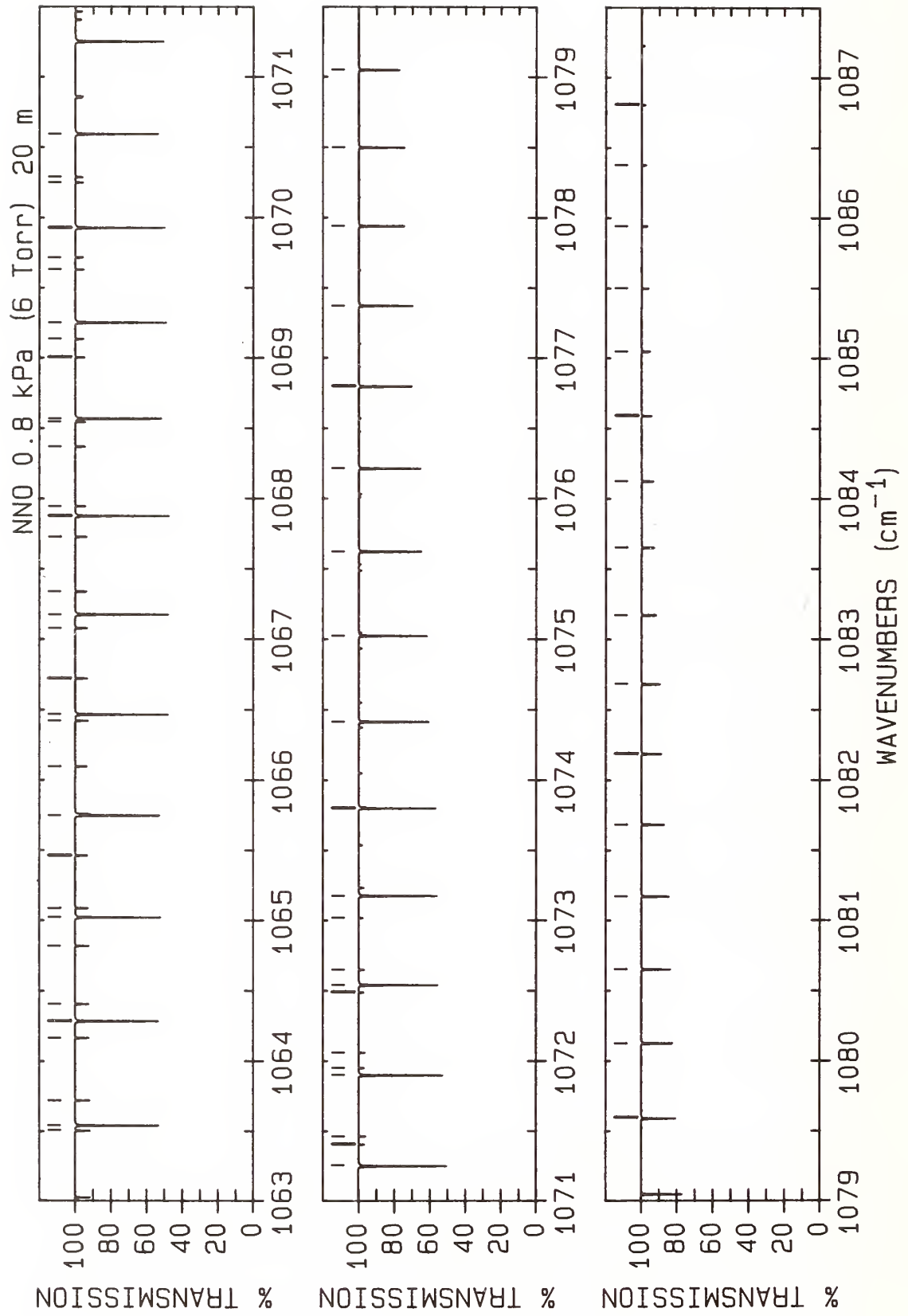

LINE #	WAVENUMBER(unc) (cm ⁻¹)	LOWER STATE (cm ⁻¹)	INTENSITY (cm/molecule)	ASSIGNMENT ROTATION BAND	LINE #	WAVENUMBER(unc) (cm ⁻¹)	LOWER STATE (cm ⁻¹)	INTENSITY (cm/molecule)	ASSIGNMENT ROTATION BAND
1	1063.506 35(8)	1893.05	0.979E-24	R(18) O	36	1071.465 78(8)	2139.10	0.487E-24	R(30) N
2	1063.542 93(7)*	1205.92	0.728E-23	R(9) M	37	1071.902 08(7)*	1362.08	0.755E-23	R(21) M
3	1063.721 57(8)	1892.54	0.981E-24	R(18) N	38	1071.952 93(8)	2193.48	0.398E-24	R(32) O
4	1064.167 53(8)	1909.04	0.954E-24	R(19) O	39	1072.062 59(8)	2165.09	0.443E-24	R(31) N
5	1064.286 90(7)*	1214.32	0.769E-23	R(10) M	40	1072.490 24(8)	2221.24	0.358E-24	R(33) O
6	1064.408 30(8)	1908.48	0.957E-24	R(19) N	41	1072.543 27(7)*	1380.55	0.721E-23	R(22) M
7	1064.819 73(8)	1925.88	0.924E-24	R(20) O	42	1072.651 99(8)	2191.91	0.401E-24	R(32) N
8	1065.022 19(7)*	1223.56	0.803E-23	R(11) M	43	1073.018 88(8)	2249.84	0.321E-24	R(34) O
9	1065.087 46(8)	1925.25	0.927E-24	R(20) N	44	1073.176 07(7)*	1399.85	0.686E-23	R(23) M
10	1065.462 98(8)	1943.56	0.888E-24	R(21) O	45	1073.800 50(7)*	1420.00	0.648E-23	R(24) M
11	1065.748 82(7)*	1233.63	0.828E-23	R(12) M	46	1074.416 61(7)*	1440.98	0.608E-23	R(25) M
12	1066.097 29(8)	1962.08	0.850E-24	R(22) O	47	1075.024 41(7)*	1462.80	0.568E-23	R(26) M
13	1066.423 15(8)	1961.32	0.853E-24	R(22) N	48	1075.623 96(7)*	1485.45	0.528E-23	R(27) M
14	1066.466 82(7)*	1244.55	0.847E-23	R(13) M	49	1076.215 28(7)*	1508.94	0.488E-23	R(28) M
15	1066.722 68(8)	1981.43	0.807E-24	R(23) O	50	1076.798 42(7)*	1533.28	0.448E-23	R(29) M
16	1067.079 69(8)	1980.61	0.811E-24	R(23) N	51	1077.373 41(7)*	1558.45	0.410E-23	R(30) M
17	1067.176 18(7)*	1256.31	0.857E-23	R(14) M	52	1077.940 29(7)*	1584.45	0.373E-23	R(31) M
18	1067.339 16(8)	2001.63	0.763E-24	R(24) O	53	1078.499 11(7)*	1611.29	0.337E-23	R(32) M
19	1067.728 71(8)	2000.74	0.767E-24	R(24) N	54	1079.049 90(7)*	1638.97	0.304E-23	R(33) M
20	1067.876 94(7)*	1268.90	0.861E-23	R(15) M	55	1079.592 70(7)*	1667.49	0.272E-23	R(34) M
21	1067.946 76(8)	2022.67	0.717E-24	R(25) O	56	1080.127 57(7)*	1696.84	0.243E-23	R(35) M
22	1068.370 24(8)	2021.71	0.720E-24	R(25) N	57	1080.654 54(7)*	1727.03	0.215E-23	R(36) M
23	1068.545 49(8)	2044.56	0.670E-24	R(26) O	58	1081.173 65(7)*	1758.06	0.190E-23	R(37) M
24	1068.569 12(7)*	1282.33	0.857E-23	R(16) M	59	1081.684 95(7)*	1789.92	0.167E-23	R(38) M
25	1069.004 27(8)	2043.51	0.673E-24	R(26) N	60	1082.188 48(7)*	1822.61	0.146E-23	R(39) M
26	1069.135 38(8)	2067.28	0.622E-24	R(27) O	61	1082.684 29(7)*	1856.14	0.127E-23	R(40) M
27	1069.252 74(7)*	1296.61	0.847E-23	R(17) M	62	1083.172 41(7)*	1890.51	0.110E-23	R(41) M
28	1069.630 82(8)	2066.15	0.626E-24	R(27) N	63	1083.652 90(7)*	1925.71	0.948E-24	R(42) M
29	1069.716 44(8)	2090.84	0.575E-24	R(28) O	64	1084.125 79(7)*	1961.75	0.813E-24	R(43) M
30	1069.927 82(7)*	1311.72	0.831E-23	R(18) M	65	1084.591 14(7)*	1998.62	0.694E-24	R(44) M
31	1070.249 92(8)	2089.63	0.579E-24	R(28) N	66	1085.048 97(7)*	2036.33	0.590E-24	R(45) M
32	1070.288 70(8)	2115.24	0.528E-24	R(29) O	67	1085.499 34(7)*	2074.87	0.499E-24	R(46) M
33	1070.594 38(7)*	1327.67	0.810E-23	R(19) M	68	1085.942 28(7)*	2114.24	0.420E-24	R(47) M
34	1071.252 46(7)*	1344.45	0.784E-23	R(20) M	69	1086.377 84(7)*	2154.45	0.352E-24	R(48) M
35	1071.406 93(8)	2166.56	0.440E-24	R(31) O	70	1086.806 06(7)*	2195.49	0.294E-24	R(49) M

ATLAS OF N₂O ABSORPTION LINES FROM 1105 cm⁻¹ to 1230 cm⁻¹

key:

Band	Isotopomer	Vibrational Transition
a	¹⁴ N ¹⁴ N ¹⁶ O	02 ⁰ 0-00 ⁰ 0
x		02 ^{2e} 0-00 ⁰ 0
b		03 ¹ 0-01 ^{1e} 0
c		03 ¹ 0-01 ^{1f} 0
d		02 ⁰ 1-00 ⁰ 1
e		04 ² 0-02 ^{2e} 0
f		04 ² 0-02 ^{2f} 0
g		04 ⁰ 0-02 ⁰ 0
p	¹⁴ N ¹⁵ N ¹⁶ O	02 ⁰ 0-00 ⁰ 0
r	¹⁵ N ¹⁴ N ¹⁶ O	02 ⁰ 0-00 ⁰ 0
t	¹⁴ N ¹⁴ N ¹⁸ O	02 ⁰ 0-00 ⁰ 0
v	¹⁴ N ¹⁴ N ¹⁷ O	02 ⁰ 0-00 ⁰ 0

If the e or f designation is not specified (for $l \neq 0$), then the transition is to either level, depending on the selection rules and the change in the rotational quantum number, J . Spectra are given for a slitwidth of 0.002 cm⁻¹ and a temperature of 296 K. For the a band a transition moment of 0.0247 debye was used and the Herman-Wallis constants given by Toth [5.218] were used in the intensity calculation. For the b and c bands the transition moment used was 0.024 debye and the same H.-W. constants were used as for band a. The g, e, and f bands used no H.-W. constants and the same transition moment as band b and c. Band d used the same transition moment as band a but used H.-W. constants $a_1 = 0.627 \times 10^{-2}$ and $a_2 = 0.185 \times 10^{-3}$. Band x derives its intensity from the l -type resonance effect on band a, but the calculated intensity was raised by using a transition moment for a of 0.03 debye (for the x intensity calculation only). Of the different isotopes, only band r was given the same intensity constants as band a although all were given the same H.-W. constants as band a. Band p used a transition moment of 0.0175 debye; band t used a transition moment of 0.035 debye; and band v used a transition moment of 0.029 debye.

ATLAS OF N₂O ABSORPTION LINES FROM 1200 cm⁻¹ to 1345 cm⁻¹

key:

Band	Isotopomer	Vibrational Transition
A	¹⁴ N ¹⁴ N ¹⁶ O	00 ⁰ 1-00 ⁰ 0
B		01 ¹ 1-01 ^{1e} 0
C		01 ¹ 1-01 ^{1f} 0
D		00 ⁰ 2-00 ⁰ 1
E		02 ² 1-02 ^{2e} 0
F		02 ² 1-02 ^{2f} 0
G		02 ⁰ 1-02 ⁰ 0
H		01 ¹ 2-01 ^{1e} 1
I		01 ¹ 2-01 ^{1f} 1
J		03 ¹ 1-03 ^{1e} 0
K		03 ¹ 1-03 ^{1f} 0
L		03 ³ 1-03 ^{3e} 0
M		03 ³ 1-03 ^{3f} 0
X		00 ⁰ 2-02 ⁰ 0
P	¹⁴ N ¹⁵ N ¹⁶ O	00 ⁰ 1-00 ⁰ 0
N		01 ¹ 1-01 ^{1e} 0
O		01 ¹ 1-01 ^{1f} 0
R	¹⁵ N ¹⁴ N ¹⁶ O	00 ⁰ 1-00 ⁰ 0
S		01 ¹ 1-01 ^{1e} 0
W		01 ¹ 1-01 ^{1f} 0
T	¹⁴ N ¹⁴ N ¹⁸ O	00 ⁰ 1-00 ⁰ 0
Y		01 ¹ 1-01 ^{1e} 0
Z		01 ¹ 1-01 ^{1f} 0
V	¹⁴ N ¹⁴ N ¹⁷ O	00 ⁰ 1-00 ⁰ 0

If the e or f designation is not specified (for $l \neq 0$), then the transition is to either level, depending on the selection rules and the change in the rotational quantum number, J . Spectra are given for a slitwidth of 0.002 cm⁻¹ and a transition moment of 0.1326 debye at a temperature of 296 K. The transition moments and Herman-Wallis constants used in the calculations were taken from Toth [5.218] after making allowance for the vibrational factors of 2, etc. included in Toth's transition moments, see Chapter III. Hot bands not covered by Toth's data were given the same transition moments and Herman-Wallis constants as the ground state transitions. The same intensity constants were used for band V as for band A.

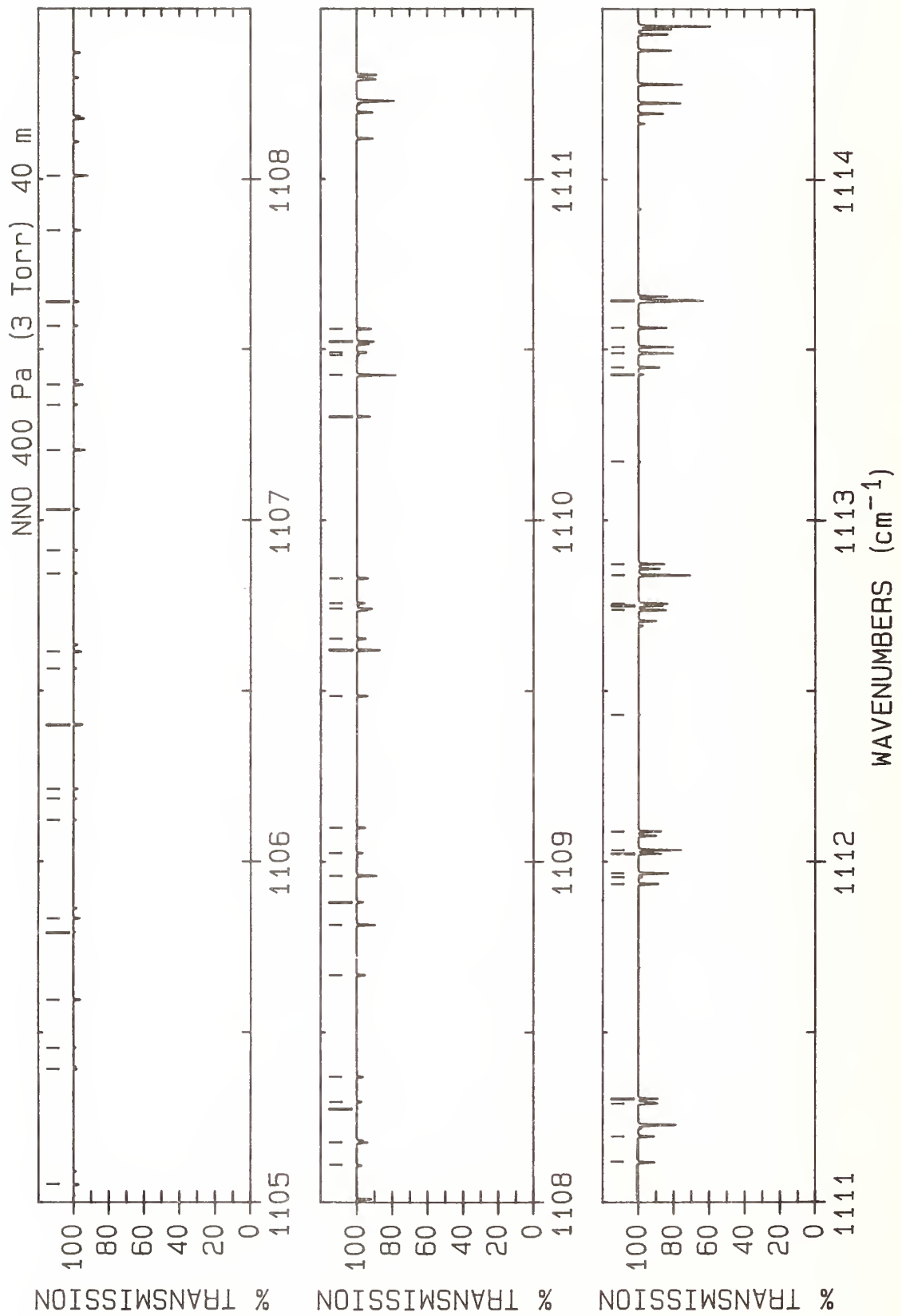

LINE #	WAVENUMBER(unc) (cm ⁻¹)	LOWER STATE (cm ⁻¹)	INTENSITY (cm/molecule)	ASSIGNMENT ROTATION BAND	LINE #	WAVENUMBER(unc) (cm ⁻¹)	LOWER STATE (cm ⁻¹)	INTENSITY (cm/molecule)	ASSIGNMENT ROTATION BAND
1	1105.053 19(6)	1025.45	0.326E-24	P(49)	36	1109.652 64(13)*	2320.08	0.550E-24	P(74)
2	1105.393 1	2701.85	0.215E-24	P(60)	37	1109.740 66(6)	792.08	0.888E-24	P(43)
3	1105.455 50(10)	2730.97	0.142E-24	P(71)	38	1109.757 2	2470.51	0.476E-24	P(55)
4	1105.596 14(6)	2494.84	0.419E-24	P(67)	39	1109.829 76(4)	2387.14	0.674E-24	P(65)
5	1105.793 05(28)*	2641.11	0.125E-24	P(79)	40	1110.302 4	2413.18	0.799E-24	P(54)
6	1105.833 99(6)	984.47	0.389E-24	P(48)	41	1110.423 91(12)*	2258.36	0.731E-24	P(73)
7	1106.121 6	2713.65	0.159E-24	P(60)	42	1110.424 29(3)	2171.55	0.179E-23	P(61)
8	1106.183 70(8)	2671.59	0.186E-24	P(70)	43	1110.483 19(6)	1398.36	0.146E-24	P(59)
9	1106.212 8	2651.66	0.271E-24	P(59)	44	1110.490 6	2424.38	0.586E-24	P(54)
10	1106.400 85(5)	2438.88	0.540E-24	P(66)	45	1110.522 83(6)	756.11	0.103E-23	P(42)
11	1106.565 45(24)*	2575.26	0.169E-24	P(78)	46	1110.560 35(4)	2332.74	0.862E-24	P(64)
12	1106.614 92(6)	944.33	0.463E-24	P(47)	47	1111.118 6	2367.97	0.979E-24	P(53)
13	1106.844 6	2663.35	0.200E-24	P(59)	48	1111.195 00(11)*	2197.45	0.968E-24	P(72)
14	1106.912 17(6)	2613.04	0.242E-24	P(69)	49	1111.291 52(3)	2279.17	0.110E-23	P(63)
15	1107.031 8	2602.30	0.339E-24	P(58)	50	1111.305 38(5)	720.96	0.119E-23	P(41)
16	1107.205 53(4)	2383.76	0.691E-24	P(65)	51	1111.934 3	2323.60	0.119E-23	P(52)
17	1107.337 59(20)*	2510.22	0.229E-24	P(77)	52	1111.954 41(5)	1306.05	0.219E-24	P(57)
18	1107.396 00(6)	905.01	0.549E-24	P(46)	53	1111.964 3	2334.64	0.873E-24	P(52)
19	1107.569 6	2613.89	0.250E-24	P(58)	54	1111.965 91(10)*	2137.38	0.128E-23	P(71)
20	1107.640 96(5)	2555.32	0.315E-24	P(68)	55	1112.023 32(3)	2226.43	0.139E-23	P(62)
21	1107.850 3	2553.77	0.423E-24	P(57)	56	1112.033 97(3)	2070.42	0.280E-23	P(59)
22	1108.010 19(4)	2329.46	0.882E-24	P(64)	57	1112.088 37(5)	686.65	0.138E-23	P(40)
23	1108.109 50(17)*	2446.02	0.308E-24	P(76)	58	1112.430 10(14)	1578.88	0.105E-24	P(62)
24	1108.177 29(6)	866.54	0.647E-24	P(45)	59	1112.736 68(10)*	2078.13	0.167E-23	P(70)
25	1108.277 08(11)	1542.71	0.766E-25	P(62)	60	1112.749 3	2280.07	0.145E-23	P(51)
26	1108.296 7	2565.26	0.311E-24	P(57)	61	1112.755 80(3)	2174.53	0.175E-23	P(61)
27	1108.370 12(5)	2498.43	0.408E-24	P(67)	62	1112.838 94(3)	2021.11	0.349E-23	P(58)
28	1108.668 3	2506.08	0.525E-24	P(56)	63	1112.871 85(5)	653.18	0.158E-23	P(39)
29	1108.814 86(3)	2275.99	0.112E-23	P(63)	64	1113.171 08(12)	1528.83	0.132E-24	P(61)
30	1108.881 18(15)*	2382.64	0.412E-24	P(75)	65	1113.426 35(4)	1216.88	0.323E-24	P(55)
31	1108.958 83(6)	828.89	0.760E-24	P(44)	66	1113.447 2	2248.24	0.128E-23	P(50)
32	1109.025 9	2517.47	0.386E-24	P(56)	67	1113.489 02(3)	2123.45	0.220E-23	P(60)
33	1109.099 70(4)	2442.37	0.525E-24	P(66)	68	1113.507 31(9)*	2019.71	0.219E-23	P(69)
34	1109.485 6	2459.21	0.649E-24	P(55)	69	1113.563 9	2237.36	0.175E-23	P(50)
35	1109.619 56(3)	2223.36	0.142E-23	P(62)	70	1113.644 04(3)	1972.62	0.432E-23	P(57)

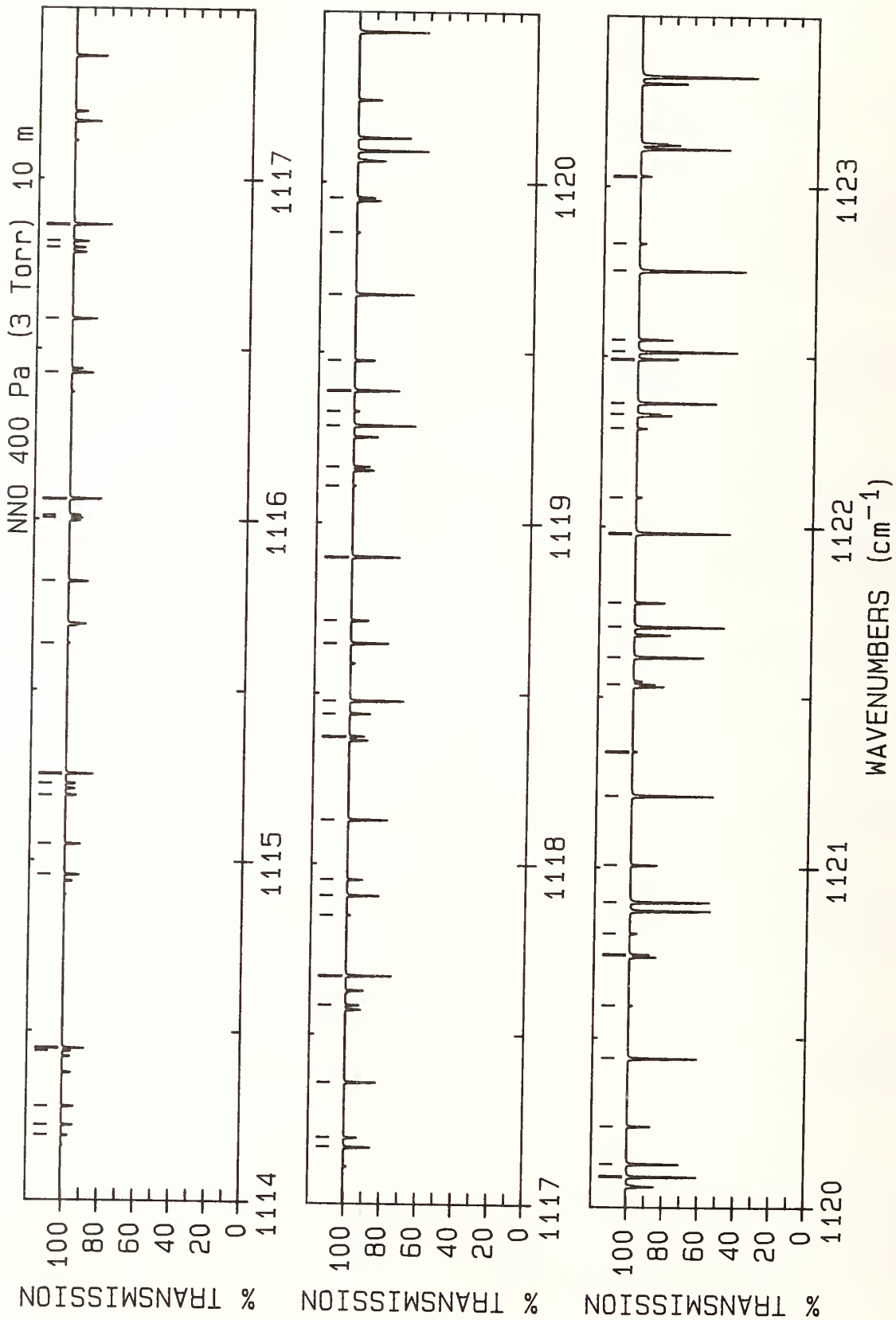

LINE #	WAVENUMBER(unc) (cm ⁻¹)	LOWER STATE (cm ⁻¹)	INTENSITY (cm/molecule)	ASSIGNMENT ROTATION BAND	LINE #	WAVENUMBER(unc) (cm ⁻¹)	LOWER STATE (cm ⁻¹)	INTENSITY (cm/molecule)	ASSIGNMENT ROTATION BAND
1	1114.192 2	2206.29	0.154E-23	P(49) e	36	1119.108 00(5)	1157.36	0.683E-24	P(53) r
2	1114.223 03(3)	2073.21	0.275E-23	P(59) c	37	1119.163 56(5)	415.46	0.396E-23	P(31) p
3	1114.277 82(9)*	1962.12	0.284E-23	P(68) a	38	1119.284 59(3)	1656.51	0.171E-22	P(50) b
4	1114.440 47(5)	588.74	0.204E-23	P(37) p	39	1119.326 68(4)	891.62	0.131E-23	P(47) t
5	1114.449 27(3)	1924.97	0.533E-23	P(56) b	40	1119.387 21(3)	1744.84	0.117E-22	P(52) c
6	1114.957 87(3)	2023.80	0.343E-23	P(58) c	41	1119.475 4	1936.08	0.492E-23	P(42) e
7	1115.048 23(9)*	1905.36	0.369E-23	P(67) a	42	1119.669 84(9)*	1582.18	0.159E-22	P(61) a
8	1115.191 3	2154.45	0.253E-23	P(48) g	43	1119.851 73(5)	1114.55	0.823E-24	P(52) r
9	1115.225 72(5)	557.77	0.231E-23	P(36) p	44	1119.953 82(5)	389.50	0.434E-23	P(30) p
10	1115.254 65(3)	1878.14	0.655E-23	P(55) b	45	1120.091 31(3)	1614.68	0.205E-22	P(49) b
11	1115.636 18(4)	1089.01	0.564E-24	P(52) t	46	1120.129 26(3)	1701.27	0.141E-22	P(51) c
12	1115.818 57(9)*	1849.42	0.476E-23	P(66) a	47	1120.240 1	1900.83	0.571E-23	P(41) e
13	1116.004 3	2114.24	0.302E-23	P(47) g	48	1120.440 18(9)*	1531.22	0.201E-22	P(60) a
14	1116.011 67(5)	527.64	0.260E-23	P(35) p	49	1120.595 94(5)	1072.53	0.987E-24	P(51) r
15	1116.060 21(3)	1832.15	0.800E-23	P(54) b	50	1120.745 12(5)	364.38	0.474E-23	P(29) p
16	1116.430 25(3)	1927.48	0.525E-23	P(56) c	51	1120.806 30(3)	818.17	0.178E-23	P(45) t
17	1116.588 85(9)*	1794.32	0.611E-23	P(65) a	52	1120.898 32(2)	1573.69	0.244E-22	P(48) b
18	1116.798 38(5)	498.34	0.291E-23	P(34) p	53	1121.007 2	1866.41	0.659E-23	P(40) e
19	1116.816 7	2074.87	0.359E-23	P(46) g	54	1121.210 60(8)*	1481.09	0.251E-22	P(59) a
20	1116.865 97(3)	1786.99	0.975E-23	P(53) b	55	1121.340 65(5)	1031.32	0.118E-23	P(50) r
21	1117.167 90(3)	1880.57	0.645E-23	P(55) c	56	1121.537 49(5)	340.10	0.514E-23	P(28) p
22	1117.196 4	2046.86	0.307E-23	P(45) e	57	1121.617 05(3)	1616.62	0.203E-22	P(49) c
23	1117.359 09(9)*	1740.04	0.782E-23	P(64) a	58	1121.705 64(2)	1533.53	0.290E-22	P(47) b
24	1117.585 89(5)	469.88	0.324E-23	P(33) p	59	1121.776 8	1832.84	0.757E-23	P(39) e
25	1117.671 94(3)	1742.67	0.118E-22	P(52) b	60	1121.981 14(8)*	1431.79	0.313E-22	P(58) a
26	1117.849 16(4)	968.22	0.946E-24	P(49) t	61	1122.085 92(4)	990.92	0.140E-23	P(49) r
27	1117.906 57(3)	1834.50	0.789E-23	P(54) c	62	1122.288 27(3)	747.87	0.238E-23	P(43) t
28	1117.953 6	2009.10	0.361E-23	P(44) e	63	1122.330 99(5)	316.65	0.555E-23	P(27) p
29	1118.129 32(9)*	1686.59	0.996E-23	P(63) a	64	1122.362 88(3)	1575.55	0.242E-22	P(48) c
30	1118.374 26(5)	442.25	0.359E-23	P(32) p	65	1122.492 2	1822.61	0.105E-22	P(39) g
31	1118.440 2	1998.62	0.499E-23	P(44) g	66	1122.513 29(2)	1494.20	0.342E-22	P(46) b
32	1118.478 14(3)	1699.17	0.143E-22	P(51) b	67	1122.548 9	1800.10	0.865E-23	P(38) e
33	1118.646 33(3)	1789.25	0.962E-23	P(53) c	68	1122.751 83(8)*	1383.33	0.389E-22	P(57) a
34	1118.713 3	1972.17	0.423E-23	P(43) e	69	1122.831 76(4)	951.32	0.166E-23	P(48) r
35	1118.899 56(9)*	1633.97	0.126E-22	P(62) a	70	1123.030 23(3)	713.90	0.274E-23	P(42) t

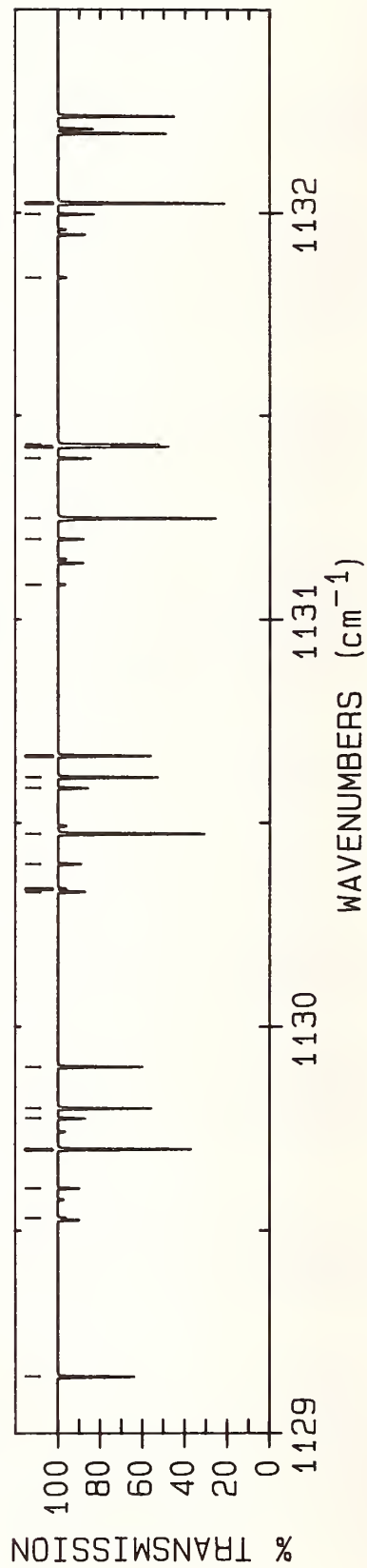
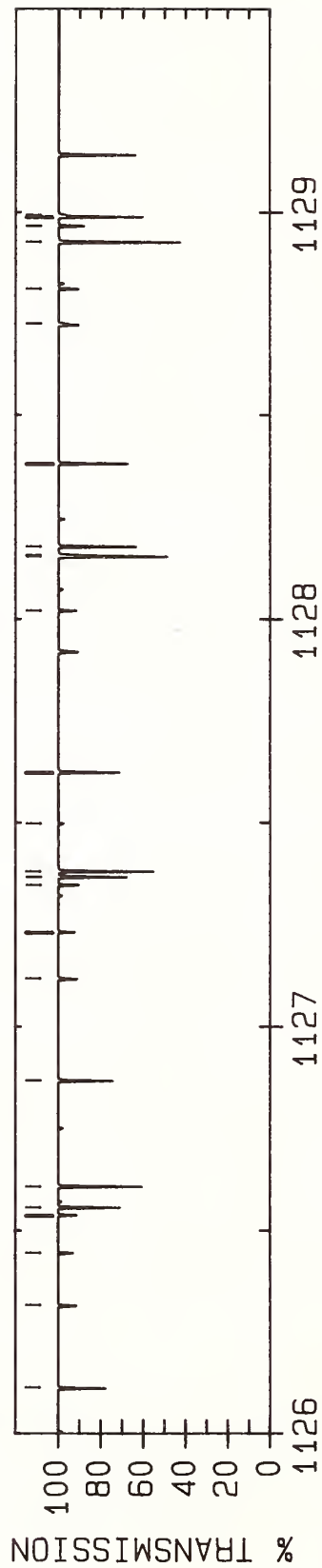
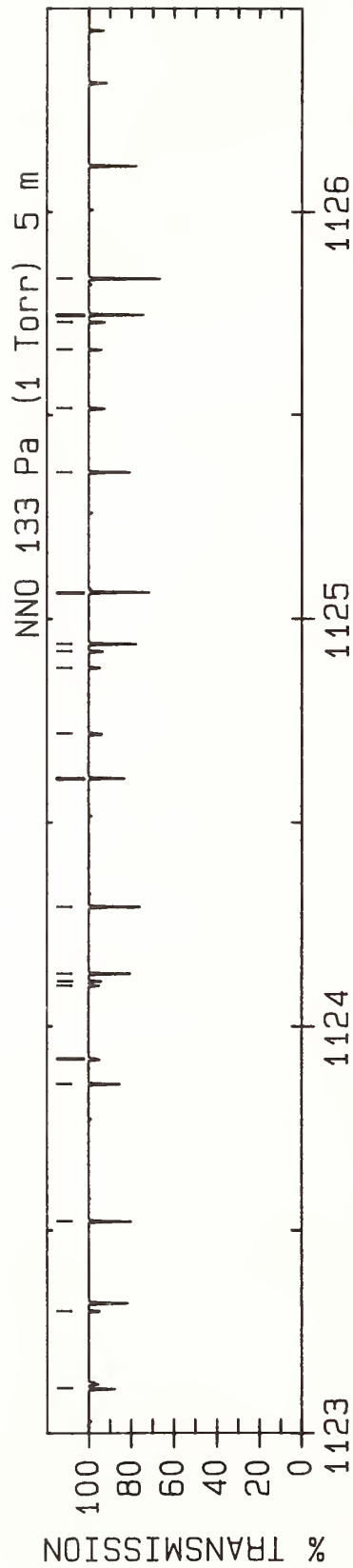

LINE #	WAVENUMBER(unc) (cm ⁻¹)	LOWER STATE (cm ⁻¹)	INTENSITY (cm/molecule)	ASSIGNMENT ROTATION BAND	LINE #	WAVENUMBER(unc) (cm ⁻¹)	LOWER STATE (cm ⁻¹)	INTENSITY (cm/molecule)	ASSIGNMENT ROTATION BAND
1	1123.110 05(2)	1535.31	0.287E-22	P(47) c	36	1128.020 5	1594.39	0.193E-22	P(31) e
2	1123.301 7	1789.92	0.120E-22	P(38) g	37	1128.153 43(8)*	1067.33	0.156E-21	P(50) a
3	1123.522 69(8)*	1335.69	0.481E-22	P(56) a	38	1128.156 6	1611.29	0.244E-22	P(32) g
4	1123.858 61(2)	1495.90	0.339E-22	P(46) c	39	1128.177 58(2)	1242.25	0.966E-22	P(39) b
5	1123.921 60(5)	272.26	0.636E-23	P(25) p	40	1128.381 28(2)	1277.04	0.839E-22	P(40) c
6	1124.100 4	1737.13	0.111E-22	P(36) e	41	1128.725 72(4)	159.19	0.833E-23	P(19) p
7	1124.111 0	1758.06	0.137E-22	P(37) g	42	1128.811 4	1568.36	0.212E-22	P(30) e
8	1124.129 65(2)	1418.04	0.471E-22	P(44) b	43	1128.926 48(8)*	1025.52	0.187E-21	P(49) a
9	1124.293 76(8)*	1288.88	0.592E-22	P(55) a	44	1128.966 0	1584.45	0.270E-22	P(31) g
10	1124.608 60(2)	1457.34	0.399E-22	P(45) c	45	1128.988 52(2)	1209.60	0.110E-21	P(38) b
11	1124.718 81(5)	251.32	0.676E-23	P(24) p	46	1128.993 44(3)	470.51	0.708E-23	P(34) t
12	1124.879 7	1706.91	0.126E-22	P(35) e	47	1129.140 62(2)	1243.48	0.961E-22	P(39) c
13	1124.920 2	1727.03	0.155E-22	P(36) g	48	1129.531 57(4)	143.27	0.852E-23	P(18) p
14	1124.938 39(2)	1381.21	0.549E-22	P(43) b	49	1129.604 5	1543.16	0.231E-22	P(29) e
15	1125.065 08(8)*	1242.91	0.725E-22	P(54) a	50	1129.699 99(8)*	984.54	0.224E-21	P(48) a
16	1125.360 05(2)	1419.61	0.467E-22	P(44) c	51	1129.775 5	1558.45	0.296E-22	P(30) g
17	1125.517 35(5)	231.22	0.713E-23	P(23) p	52	1129.799 95(2)	1177.78	0.125E-21	P(37) b
18	1125.661 5	1677.52	0.141E-22	P(34) e	53	1129.901 65(2)	1210.77	0.109E-21	P(38) c
19	1125.729 3	1696.84	0.175E-22	P(35) g	54	1130.330 36(3)	599.64	0.711E-23	P(38) r
20	1125.747 54(2)	1345.22	0.636E-22	P(42) b	55	1130.339 01(4)	128.19	0.865E-23	P(17) p
21	1125.836 67(8)*	1197.77	0.884E-22	P(53) a	56	1130.399 8	1518.81	0.252E-22	P(28) e
22	1126.113 01(2)	1382.71	0.545E-22	P(43) c	57	1130.473 99(8)*	944.39	0.266E-21	P(47) a
23	1126.317 26(5)	211.96	0.748E-23	P(22) p	58	1130.585 4	1533.28	0.324E-22	P(29) g
24	1126.445 5	1648.97	0.157E-22	P(33) e	59	1130.611 90(2)	1146.80	0.141E-21	P(36) b
25	1126.538 3	1667.49	0.197E-22	P(34) g	60	1130.664 39(2)	1178.89	0.124E-21	P(37) c
26	1126.557 10(2)	1310.06	0.735E-22	P(41) b	61	1131.085 05(3)	568.91	0.802E-23	P(37) r
27	1126.608 56(8)*	1153.46	0.107E-21	P(52) a	62	1131.197 1	1495.29	0.272E-22	P(27) e
28	1126.867 51(2)	1346.65	0.632E-22	P(42) c	63	1131.248 54(8)*	905.08	0.314E-21	P(46) a
29	1127.118 60(5)	193.53	0.780E-23	P(21) p	64	1131.395 5	1508.94	0.353E-22	P(28) g
30	1127.231 9	1621.26	0.174E-22	P(32) e	65	1131.424 37(2)	1116.65	0.158E-21	P(35) b
31	1127.347 4	1638.97	0.219E-22	P(33) g	66	1131.428 88(2)	1147.85	0.140E-21	P(36) c
32	1127.367 11(2)	1275.74	0.844E-22	P(40) b	67	1131.840 77(3)	538.98	0.900E-23	P(36) r
33	1127.380 81(8)*	1109.98	0.130E-21	P(51) a	68	1131.996 5	1472.61	0.293E-22	P(26) e
34	1127.497 60(3)	526.63	0.573E-23	P(36) t	69	1131.996 60(3)	367.75	0.102E-22	P(30) t
35	1127.623 59(2)	1311.42	0.730E-22	P(41) c	70	1132.023 66(8)*	866.60	0.370E-21	P(45) a

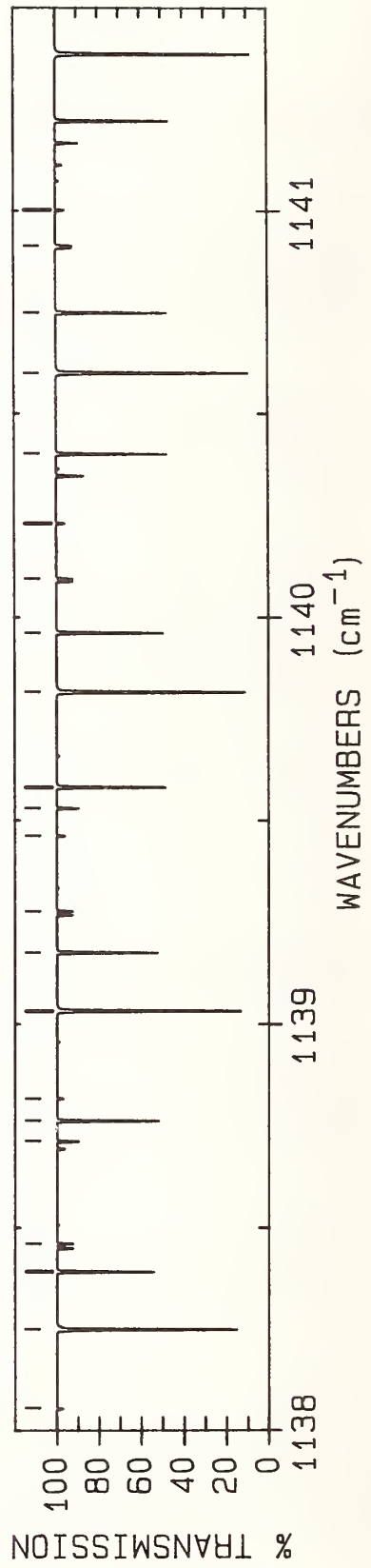
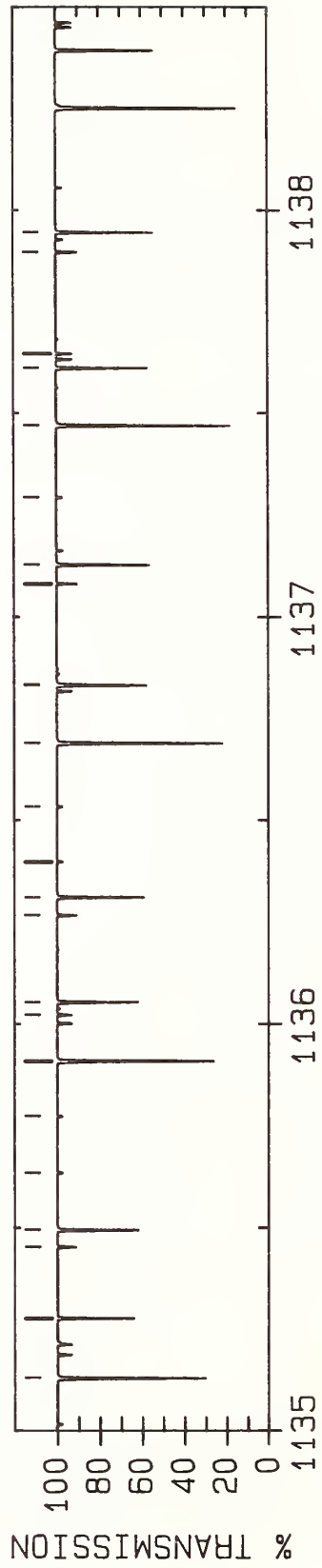
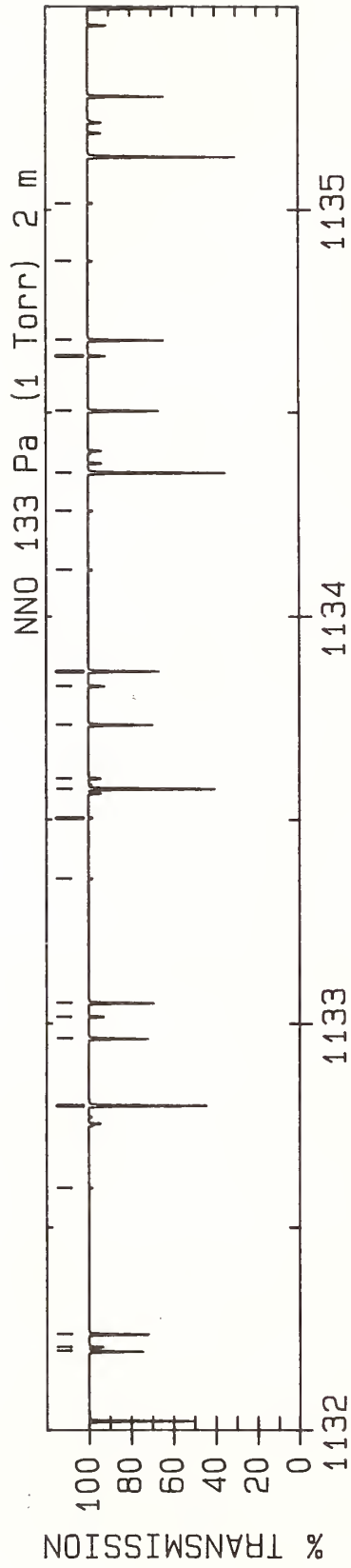

LINE #	WAVENUMBER(unc) (cm ⁻¹)	LOWER STATE (cm ⁻¹)	INTENSITY (cm/molecule)	ASSIGNMENT ROTATION BAND	LINE #	WAVENUMBER(unc) (cm ⁻¹)	LOWER STATE (cm ⁻¹)	INTENSITY (cm/molecule)	ASSIGNMENT ROTATION BAND
1	1132.195 14(2)	1117.64	0.157E-21	P(35) c	36	1136.533 27(3)	237.29	0.152E-22	P(24) t
2	1132.206 1	1485.45	0.382E-22	P(27) g	37	1136.688 94(8)*	653.23	0.893E-21	P(39) a
3	1132.237 39(2)	1087.34	0.176E-21	P(34) b	38	1136.831 65(2)	954.01	0.284E-21	P(29) c
4	1132.597 56(3)	509.86	0.101E-22	P(35) r	39	1136.834 0	1354.18	0.401E-22	P(20) e
5	1132.799 41(8)*	828.95	0.433E-21	P(44) a	40	1137.081 5	1362.08	0.545E-22	P(21) g
6	1132.963 21(2)	1088.28	0.176E-21	P(34) c	41	1137.127 86(2)	929.02	0.309E-21	P(28) b
7	1133.017 1	1462.80	0.411E-22	P(26) g	42	1137.293 41(3)	218.31	0.160E-22	P(23) t
8	1133.050 97(2)	1058.86	0.196E-21	P(33) b	43	1137.469 31(8)*	620.59	0.102E-20	P(38) a
9	1133.355 43(3)	481.55	0.112E-22	P(34) r	44	1137.611 12(2)	929.66	0.309E-21	P(28) c
10	1133.504 36(3)	321.11	0.119E-22	P(28) t	45	1137.646 7	1337.38	0.413E-22	P(19) e
11	1133.575 82(8)*	792.14	0.505E-21	P(43) a	46	1137.896 6	1344.45	0.566E-22	P(20) g
12	1133.601 4	1429.78	0.333E-22	P(24) e	47	1137.945 14(2)	905.56	0.334E-21	P(27) b
13	1133.733 12(2)	1059.75	0.195E-21	P(33) c	48	1138.054 77(3)	200.12	0.167E-22	P(22) t
14	1133.828 7	1440.98	0.440E-22	P(25) g	49	1138.250 59(8)*	588.78	0.115E-20	P(37) a
15	1133.865 13(2)	1031.22	0.217E-21	P(32) b	50	1138.392 59(2)	906.16	0.333E-21	P(27) c
16	1134.114 44(3)	454.04	0.124E-22	P(33) r	51	1138.461 1	1321.41	0.422E-22	P(18) e
17	1134.259 88(3)	298.97	0.128E-22	P(27) t	52	1138.712 6	1327.67	0.584E-22	P(19) g
18	1134.352 93(8)*	756.16	0.587E-21	P(42) a	53	1138.763 10(2)	882.94	0.358E-21	P(26) b
19	1134.504 90(2)	1032.06	0.216E-21	P(32) c	54	1138.817 36(3)	182.72	0.173E-22	P(21) t
20	1134.640 8	1420.00	0.468E-22	P(24) g	55	1139.032 84(8)*	557.81	0.130E-20	P(36) a
21	1134.679 88(2)	1004.42	0.239E-21	P(31) b	56	1139.176 06(2)	883.50	0.357E-21	P(26) c
22	1134.874 62(3)	427.35	0.136E-22	P(32) r	57	1139.277 1	1306.29	0.429E-22	P(17) e
23	1135.016 52(3)	277.62	0.136E-22	P(26) t	58	1139.461 98(3)	284.13	0.220E-22	P(26) r
24	1135.130 80(8)*	721.01	0.678E-21	P(41) a	59	1139.529 6	1311.72	0.598E-22	P(18) g
25	1135.278 56(2)	1005.20	0.238E-21	P(31) c	60	1139.581 20(3)	166.12	0.178E-22	P(20) t
26	1135.453 6	1399.85	0.495E-22	P(23) g	61	1139.581 73(2)	861.16	0.382E-21	P(25) b
27	1135.495 24(2)	978.45	0.262E-21	P(30) b	62	1139.816 10(8)*	527.67	0.146E-20	P(35) a
28	1135.636 00(3)	401.46	0.150E-22	P(31) r	63	1139.961 56(2)	861.67	0.381E-21	P(25) c
29	1135.774 31(3)	257.06	0.144E-22	P(25) t	64	1140.094 8	1292.01	0.432E-22	P(16) e
30	1135.909 45(8)*	686.70	0.780E-21	P(40) a	65	1140.231 21(3)	263.09	0.234E-22	P(25) r
31	1136.023 1	1371.82	0.386E-22	P(21) e	66	1140.401 06(2)	840.21	0.405E-21	P(24) b
32	1136.054 13(2)	979.18	0.261E-21	P(30) c	67	1140.600 40(8)*	498.37	0.164E-20	P(34) a
33	1136.267 2	1380.55	0.521E-22	P(22) g	68	1140.749 10(2)	840.68	0.404E-21	P(24) c
34	1136.311 23(2)	953.32	0.285E-21	P(29) b	69	1140.914 1	1278.57	0.432E-22	P(15) e
35	1136.398 61(3)	376.38	0.163E-22	P(30) r	70	1141.001 85(3)	242.85	0.248E-22	P(24) r

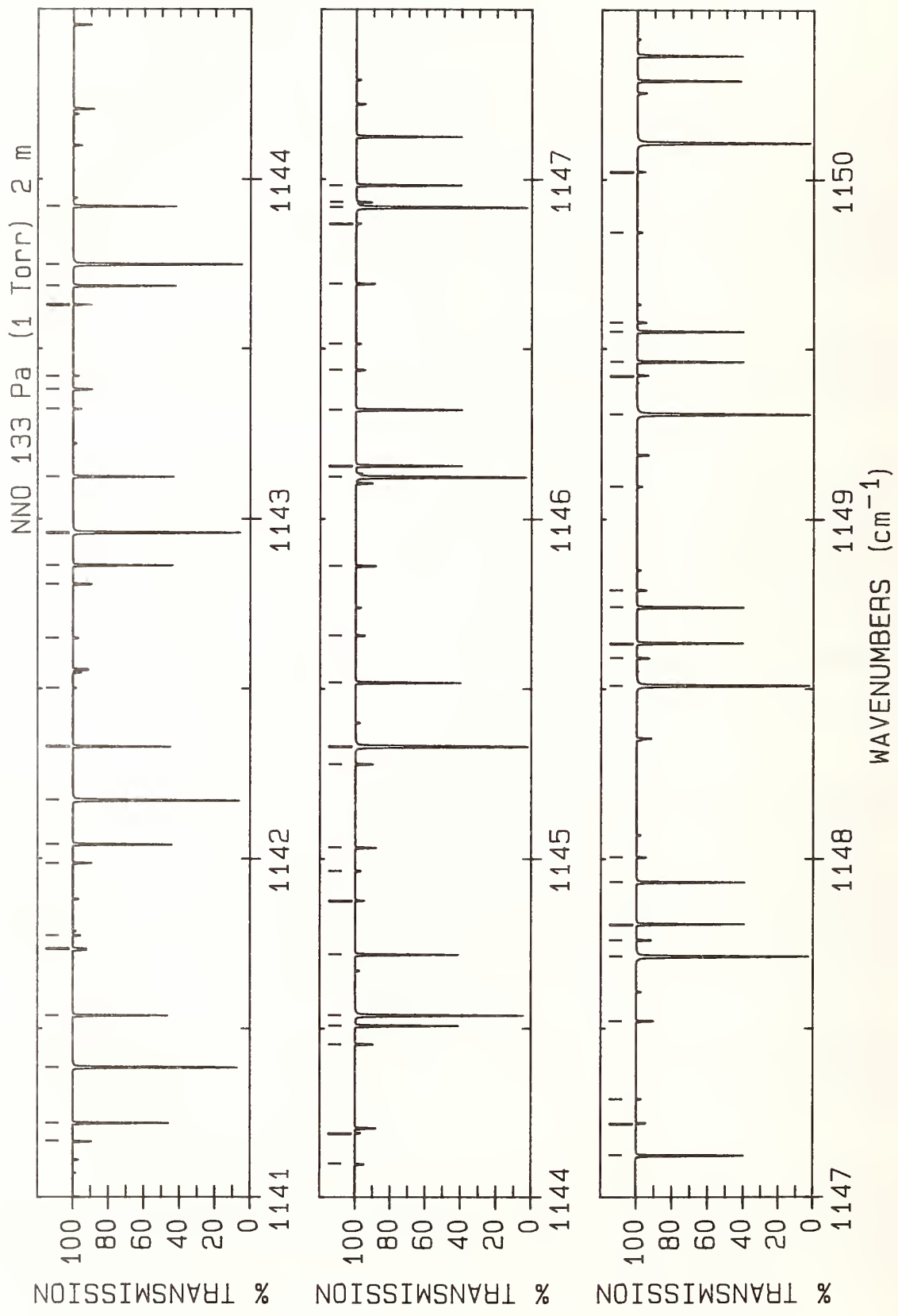

LINE #	WAVENUMBER(cm^{-1})	LOWER STATE (cm^{-1})	INTENSITY ($\text{cm}/\text{molecule}$)	ASSIGNMENT ROTATION BAND	LINE #	WAVENUMBER(unc) (cm^{-1})	LOWER STATE (cm^{-1})	INTENSITY ($\text{cm}/\text{molecule}$)	ASSIGNMENT ROTATION BAND
1	1141.166 6	1282.33	0.614E-22	P(16) g	36	1145.518 29(2)	732.38	0.509E-21	P(18) c
2	1141.221 10(2)	820.10	0.427E-21	P(23) b	37	1145.656 72(3)	138.44	0.306E-22	P(18) r
3	1141.385 80(8)*	469.91	0.182E-20	P(33) a	38	1145.861 8	1215.56	0.342E-22	P(9) e
4	1141.538 70(2)	820.54	0.427E-21	P(23) c	39	1146.123 30(8)*	316.67	0.311E-20	P(27) a
5	1141.735 0	1265.97	0.428E-22	P(14) e	40	1146.156 83(2)	717.02	0.517E-21	P(17) b
6	1141.773 93(3)	223.43	0.260E-22	P(23) r	41	1146.320 61(2)	717.26	0.516E-21	P(17) c
7	1141.986 6	1268.90	0.615E-22	P(15) g	42	1146.437 91(3)	123.87	0.310E-22	P(17) r
8	1142.041 86(2)	800.83	0.448E-21	P(22) b	43	1146.514 52(4)	52.21	0.169E-22	P(11) t
9	1142.172 32(8)*	442.28	0.202E-20	P(32) a	44	1146.691 5	1207.99	0.312E-22	P(8) e
10	1142.330 39(2)	801.23	0.448E-21	P(22) c	45	1146.869 02(3)	653.23	0.165E-22	P(39) x
11	1142.502 09(3)	866.60	0.117E-22	P(45) x	46	1146.917 44(8)*	294.06	0.334E-20	P(26) a
12	1142.649 37(3)	107.58	0.189E-22	P(16) t	47	1146.932 2	1205.92	0.504E-22	P(9) g
13	1142.807 9	1256.31	0.611E-22	P(14) g	48	1146.982 13(2)	702.77	0.520E-21	P(16) b
14	1142.863 35(2)	782.39	0.467E-21	P(21) b	49	1147.125 10(2)	702.99	0.520E-21	P(16) c
15	1142.960 02(8)*	415.49	0.222E-20	P(31) a	50	1147.220 70(3)	110.11	0.312E-22	P(16) r
16	1143.124 18(2)	782.76	0.466E-21	P(21) c	51	1147.291 66(4)	43.51	0.160E-22	P(10) t
17	1143.322 49(3)	187.01	0.283E-22	P(21) r	52	1147.522 5	1201.27	0.276E-22	P(7) e
18	1143.381 3	1243.28	0.407E-22	P(12) e	53	1147.712 98(8)*	272.28	0.356E-20	P(25) a
19	1143.419 70(3)	94.93	0.188E-22	P(15) t	54	1147.761 0	1198.37	0.465E-22	P(8) g
20	1143.630 3	1244.55	0.601E-22	P(13) g	55	1147.808 22(2)	689.36	0.520E-21	P(15) b
21	1143.685 58(2)	764.79	0.484E-21	P(20) b	56	1147.931 77(2)	689.55	0.520E-21	P(15) c
22	1143.748 93(8)*	389.53	0.244E-20	P(30) a	57	1148.005 09(3)	97.16	0.311E-22	P(15) r
23	1143.920 08(2)	765.12	0.483E-21	P(20) c	58	1148.509 95(8)*	251.34	0.378E-20	P(24) a
24	1144.099 03(3)	170.01	0.292E-22	P(20) r	59	1148.591 1	1191.65	0.420E-22	P(7) g
25	1144.191 37(3)	83.06	0.186E-22	P(14) t	60	1148.635 11(2)	676.79	0.515E-21	P(14) b
26	1144.453 9	1233.63	0.586E-22	P(12) g	61	1148.740 62(2)	676.95	0.515E-21	P(14) c
27	1144.508 57(2)	748.03	0.498E-21	P(19) b	62	1148.791 11(4)	85.01	0.308E-22	P(14) r
28	1144.539 08(8)*	364.41	0.266E-20	P(29) a	63	1149.096 18(3)	557.81	0.177E-22	P(36) x
29	1144.718 11(2)	748.33	0.497E-21	P(19) c	64	1149.308 38(8)*	231.24	0.399E-20	P(23) a
30	1144.877 10(3)	153.82	0.300E-22	P(19) r	65	1149.422 5	1185.77	0.371E-22	P(6) g
31	1144.964 39(4)	71.99	0.182E-22	P(13) t	66	1149.462 79(2)	665.05	0.506E-21	P(13) b
32	1145.033 6	1223.96	0.368E-22	P(10) e	67	1149.551 67(2)	665.20	0.505E-21	P(13) c
33	1145.278 7	1223.56	0.564E-22	P(11) g	68	1149.578 76(4)	73.68	0.302E-22	P(13) r
34	1145.330 53(8)*	340.12	0.288E-20	P(28) a	69	1149.844 80(3)	527.67	0.179E-22	P(35) x
35	1145.332 31(2)	732.11	0.509E-21	P(18) b	70	1150.023 7	1186.15	0.139E-22	P(4) e

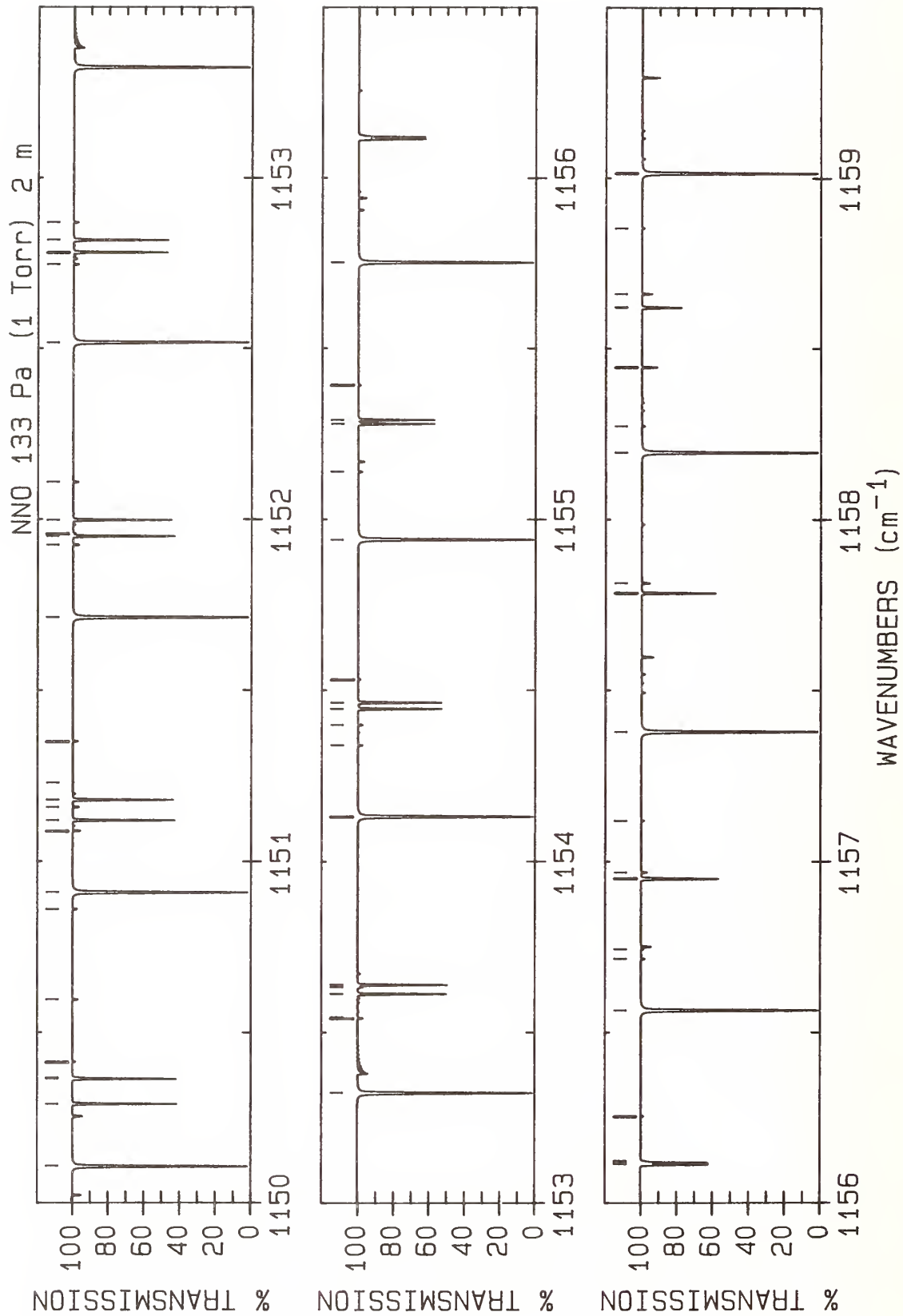

LINE #	WAVENUMBER(unc) (cm ⁻¹)	LOWER STATE (cm ⁻¹)	INTENSITY (cm/molecule)	ASSIGNMENT ROTATION BAND	LINE #	WAVENUMBER(unc) (cm ⁻¹)	LOWER STATE (cm ⁻¹)	INTENSITY (cm/molecule)	ASSIGNMENT ROTATION BAND
1	1150.108 31(8)*	211.97	0.418E-20	P(22) a	36	1154.339 79(5)	22.67	0.149E-22	P(7) r
2	1150.291 28(2)	654.15	0.491E-21	P(12) b	37	1154.399 49(4)	364.41	0.155E-22	P(29) x
3	1150.364 92(2)	654.28	0.491E-21	P(12) c	38	1154.446 00(2)	612.24	0.346E-21	P(7) b
4	1150.368 07(4)	63.15	0.211E-22	P(12) r	39	1154.464 41(1)	612.29	0.346E-21	P(7) c
5	1150.414 12(5)	16.61	0.110E-22	P(6) t	40	1154.531 58(4)	55.30	0.882E-23	R(11) p
6	1150.596 49(3)	498.37	0.179E-22	P(34) x	41	1154.940 98(8)*	113.96	0.487E-20	P(16) a
7	1150.860 0	1182.79	0.786E-23	P(3) e	42	1155.139 23(5)	17.00	0.132E-22	P(6) r
8	1150.860 0	1182.79	0.785E-23	P(3) f	43	1155.279 42(2)	606.37	0.303E-21	P(6) b
9	1150.909 77(8)*	193.54	0.436E-20	P(21) a	44	1155.290 98(2)	606.41	0.303E-21	P(6) c
10	1151.089 6	1176.53	0.259E-22	P(4) g	45	1155.392 68(4)	65.36	0.912E-23	R(12) p
11	1151.120 59(1)	644.10	0.472E-21	P(11) b	46	1155.752 18(8)*	100.55	0.487E-20	P(15) a
12	1151.159 05(4)	53.44	0.203E-22	P(11) r	47	1156.113 66(2)	601.34	0.256E-21	P(5) b
13	1151.180 38(2)	644.20	0.472E-21	P(11) c	48	1156.119 79(2)	601.37	0.256E-21	P(5) c
14	1151.230 21(9)*	1725.33	0.364E-23	P(32) d	49	1156.124 4	1168.97	0.135E-22	R(1) g
15	1151.351 19(3)	469.91	0.177E-22	P(33) x	50	1156.255 38(4)	76.25	0.933E-23	R(13) p
16	1151.712 79(8)*	175.95	0.452E-20	P(20) a	51	1156.565 08(8)*	87.98	0.482E-20	P(14) a
17	1151.925 2	1173.17	0.198E-22	P(3) g	52	1156.715 68(4)	294.06	0.126E-22	P(26) x
18	1151.950 71(1)	634.88	0.448E-21	P(10) b	53	1156.743 23(5)	8.10	0.917E-23	P(4) r
19	1151.951 70(4)	44.53	0.192E-22	P(10) r	54	1156.948 73(2)	597.15	0.204E-21	P(4) b
20	1151.958 22(5)	30.17	0.744E-23	R(8) p	55	1156.950 82(2)	597.17	0.204E-21	P(4) c
21	1151.998 06(1)	634.96	0.448E-21	P(10) c	56	1156.968 4	1170.65	0.201E-22	R(2) g
22	1152.108 87(4)	442.28	0.174E-22	P(32) x	57	1157.119 64(4)	87.98	0.946E-23	R(14) p
23	1152.517 40(8)*	159.20	0.465E-20	P(19) a	58	1157.379 71(8)*	76.25	0.474E-20	P(13) a
24	1152.746 03(4)	36.44	0.180E-22	P(9) r	59	1157.784 08(2)	593.81	0.147E-21	P(3) c
25	1152.781 65(1)	626.49	0.419E-21	P(9) b	60	1157.784 62(2)	593.80	0.147E-21	P(3) b
26	1152.817 95(1)	626.56	0.419E-21	P(9) c	61	1157.813 7	1173.17	0.265E-22	R(3) g
27	1152.869 51(4)	415.49	0.169E-22	P(31) x	62	1158.196 08(8)*	65.36	0.461E-20	P(12) a
28	1153.323 61(8)*	143.28	0.476E-20	P(18) a	63	1158.273 57(4)	251.34	0.104E-22	P(24) x
29	1153.540 3	1278.56	0.153E-23	Q(15) f	64	1158.445 2	1190.35	0.244E-22	R(5) f
30	1153.542 06(5)	29.15	0.166E-22	P(8) r	65	1158.445 5	1190.35	0.244E-22	R(5) e
31	1153.544 8	1292.01	0.135E-23	Q(16) e	66	1158.619 57(2)	591.29	0.840E-22	P(2) c
32	1153.613 41(2)	618.95	0.385E-21	P(8) b	67	1158.621 34(2)	591.28	0.840E-22	P(2) b
33	1153.633 06(4)	389.53	0.163E-22	P(30) x	68	1158.660 4	1176.53	0.326E-22	R(4) g
34	1153.640 07(1)	619.00	0.385E-21	P(8) c	69	1158.852 68(4)	113.95	0.949E-23	R(16) p
35	1154.131 47(8)*	128.20	0.483E-20	P(17) a	70	1159.014 20(8)*	55.31	0.444E-20	P(11) a

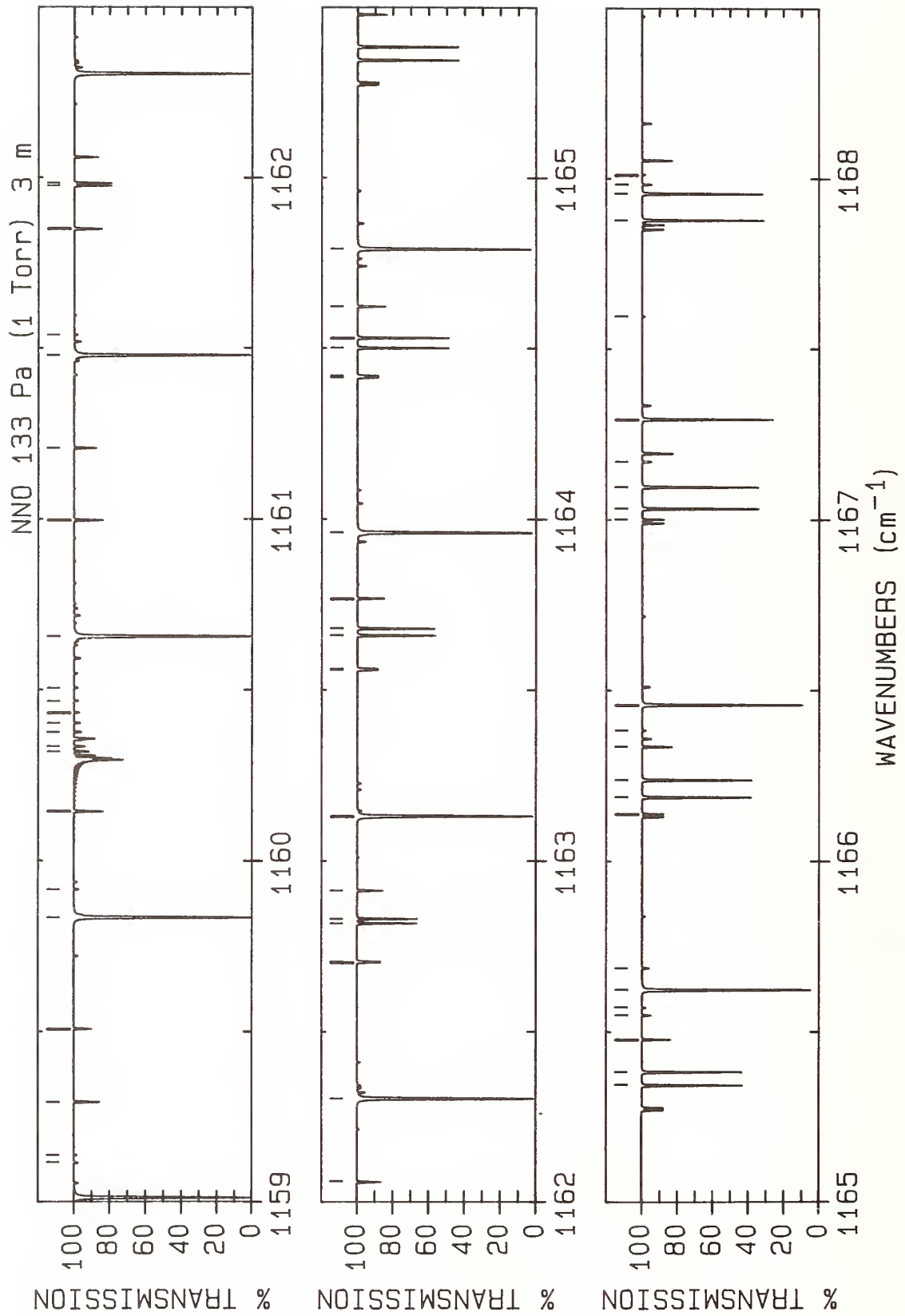

LINE #	WAVENUMBER(unc) (cm ⁻¹)	LOWER STATE (cm ⁻¹)	INTENSITY (cm/molecule)	ASSIGNMENT ROTATION BAND	LINE #	WAVENUMBER(unc) (cm ⁻¹)	LOWER STATE (cm ⁻¹)	INTENSITY (cm/molecule)	ASSIGNMENT ROTATION BAND
1	1159.116 61(5)	7.91	0.959E-23	R(4) t	36	1163.558 2	1233.20	0.435E-22	R(11) f
2	1159.138 90(9)*	1495.99	0.716E-23	P(22) d	37	1163.561 8	1233.20	0.435E-22	R(11) e
3	1159.294 4	1195.39	0.287E-22	R(6) f	38	1163.658 73(2)	593.80	0.208E-21	R(3) b
4	1159.294 8	1195.39	0.287E-22	R(6) e	39	1163.679 11(2)	593.81	0.208E-21	R(3) c
5	1159.508 4	1180.73	0.384E-22	R(5) g	40	1163.767 1	1214.32	0.600E-22	R(10) g
6	1159.834 10(8)*	46.09	0.422E-20	P(10) a	41	1163.960 51(8)*	12.57	0.248E-20	P(5) a
7	1159.916 07(5)	11.87	0.113E-22	R(5) t	42	1164.414 5	1243.28	0.451E-22	R(12) f
8	1160.144 7	1201.27	0.326E-22	R(7) f	43	1164.419 4	1243.28	0.451E-22	R(12) e
9	1160.145 5	1201.27	0.326E-22	R(7) e	44	1164.501 09(2)	597.15	0.263E-21	R(4) b
10	1160.146 17(2)	748.33	0.273E-23	Q(19) c	45	1164.530 08(2)	597.17	0.263E-21	R(4) c
11	1160.320 04(2)	593.80	0.323E-22	Q(3) b	46	1164.622 4	1223.56	0.626E-22	R(11) g
12	1160.335 24(2)	597.15	0.245E-22	Q(4) b	47	1164.791 24(8)*	8.38	0.203E-20	P(4) a
13	1160.377 01(1)	606.37	0.162E-22	Q(6) b	48	1165.344 23(2)	601.34	0.313E-21	R(5) b
14	1160.403 57(1)	612.24	0.136E-22	Q(7) b	49	1165.383 23(1)	601.37	0.313E-21	R(5) c
15	1160.433 90(1)	618.95	0.116E-22	Q(8) b	50	1165.478 7	1233.63	0.646E-22	R(12) g
16	1160.468 01(1)	626.49	0.100E-22	Q(9) b	51	1165.549 43(3)	61.71	0.194E-22	R(12) t
17	1160.505 87(2)	634.88	0.871E-23	Q(10) b	52	1165.572 01(9)*	1372.52	0.833E-23	P(14) d
18	1160.655 77(8)*	37.71	0.395E-20	P(9) a	53	1165.623 79(8)*	5.03	0.154E-20	P(3) a
19	1160.996 3	1207.99	0.360E-22	R(8) f	54	1165.687 22(5)	17.00	0.155E-22	R(6) r
20	1160.997 5	1207.99	0.360E-22	R(8) e	55	1166.139 0	1265.97	0.470E-22	R(14) e
21	1161.208 3	1191.65	0.486E-22	R(7) g	56	1166.188 14(2)	606.37	0.360E-21	R(6) b
22	1161.479 25(8)*	30.17	0.364E-20	P(8) a	57	1166.238 55(1)	606.41	0.360E-21	R(6) c
23	1161.539 32(8)*	1443.43	0.795E-23	P(19) d	58	1166.336 0	1244.55	0.660E-22	R(13) g
24	1161.849 1	1215.55	0.390E-22	R(9) f	59	1166.383 54(9)*	1360.84	0.822E-23	P(13) d
25	1161.850 9	1215.56	0.390E-22	R(9) e	60	1166.458 17(8)*	2.51	0.104E-20	P(2) a
26	1161.976 37(2)	589.61	0.849E-22	R(1) b	61	1167.001 1	1278.57	0.473E-22	R(15) e
27	1161.983 76(2)	589.61	0.849E-22	R(1) c	62	1167.032 81(1)	612.24	0.402E-21	R(7) b
28	1162.060 1	1198.37	0.530E-22	R(8) g	63	1167.096 04(1)	612.29	0.402E-21	R(7) c
29	1162.304 52(8)*	23.46	0.329E-20	P(7) a	64	1167.170 45(3)	83.06	0.203E-22	R(14) t
30	1162.703 0	1223.96	0.415E-22	R(10) f	65	1167.294 36(8)*	0.84	0.526E-21	P(1) a
31	1162.705 7	1223.96	0.415E-22	R(10) e	66	1167.596 08(5)	294.04	0.643E-23	R(26) p
32	1162.817 15(2)	591.28	0.150E-21	R(2) b	67	1167.878 23(1)	618.95	0.440E-21	R(8) b
33	1162.830 33(2)	591.29	0.150E-21	R(2) c	68	1167.955 67(1)	619.00	0.440E-21	R(8) c
34	1162.913 0	1205.92	0.567E-22	R(9) g	69	1167.982 79(3)	94.93	0.205E-22	R(15) t
35	1163.131 61(8)*	17.60	0.290E-20	P(6) a	70	1168.011 76(9)*	1339.98	0.777E-23	P(11) d

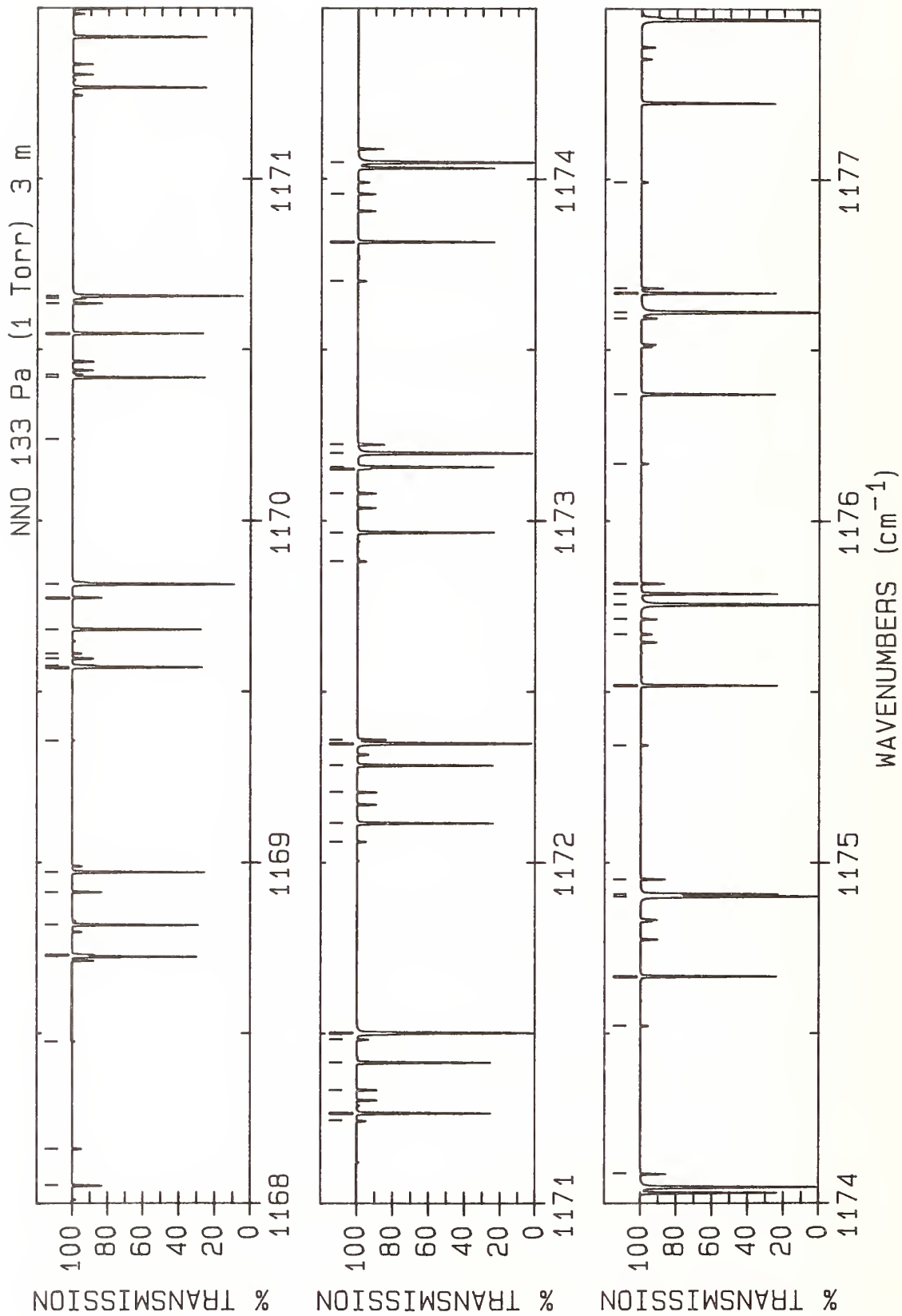

LINE #	WAVENUMBER(unc) (cm ⁻¹)	LOWER STATE (cm ⁻¹)	INTENSITY (cm/molecule)	ASSIGNMENT ROTATION BAND	LINE #	WAVENUMBER(unc) (cm ⁻¹)	LOWER STATE (cm ⁻¹)	INTENSITY (cm/molecule)	ASSIGNMENT ROTATION BAND
1	1168.053 4	1268.90	0.671E-22	R(15) g	36	1172.360 7	1344.45	0.612E-22	R(20) g
2	1168.161 53(4)	36.44	0.203E-22	R(9) r	37	1172.880 95(3)	182.72	0.187E-22	R(21) t
3	1168.476 32(5)	316.65	0.599E-23	R(27) p	38	1172.965 83(2)	676.79	0.564E-21	R(14) b
4	1168.724 40(1)	626.49	0.473E-21	R(9) b	39	1173.080 5	1390.30	0.400E-22	R(22) e
5	1168.729 8	1306.29	0.467E-22	R(17) e	40	1173.152 60(3)	97.16	0.244E-22	R(15) r
6	1168.817 45(2)	626.56	0.473E-21	R(9) c	41	1173.157 88(2)	676.95	0.564E-21	R(14) c
7	1168.913 4	1282.33	0.668E-22	R(16) g	42	1173.198 42(8)*	12.57	0.300E-20	R(5) a
8	1168.972 23(8)*	0.00	0.529E-21	R(0) a	43	1173.224 0	1362.08	0.588E-22	R(21) g
9	1169.357 39(5)	340.10	0.555E-23	R(28) p	44	1173.701 11(3)	200.12	0.180E-22	R(22) t
10	1169.571 28(2)	634.88	0.502E-21	R(10) b	45	1173.816 15(2)	689.36	0.568E-21	R(15) b
11	1169.575 9	1321.41	0.459E-22	R(18) f	46	1173.955 8	1409.62	0.380E-22	R(23) e
12	1169.596 6	1321.41	0.459E-22	R(18) e	47	1174.048 97(8)*	17.60	0.342E-20	R(6) a
13	1169.611 01(3)	121.03	0.204E-22	R(17) t	48	1174.087 8	1380.55	0.563E-22	R(22) g
14	1169.681 34(2)	634.96	0.501E-21	R(10) c	49	1174.522 27(3)	218.31	0.172E-22	R(23) t
15	1169.774 2	1296.61	0.661E-22	R(17) g	50	1174.667 10(2)	702.77	0.567E-21	R(16) b
16	1169.813 88(8)*	0.84	0.106E-20	R(1) a	51	1174.901 27(8)*	23.46	0.381E-20	R(7) a
17	1170.239 25(5)	364.38	0.511E-23	R(29) p	52	1174.908 47(2)	702.99	0.567E-21	R(16) c
18	1170.418 89(2)	644.10	0.525E-21	R(11) b	53	1174.951 9	1399.85	0.535E-22	R(23) g
19	1170.426 84(3)	135.27	0.201E-22	R(18) t	54	1175.344 42(3)	237.29	0.164E-22	R(24) t
20	1170.547 35(2)	644.20	0.525E-21	R(11) c	55	1175.518 68(2)	717.02	0.562E-21	R(17) b
21	1170.635 7	1311.72	0.648E-22	R(18) g	56	1175.668 17(3)	138.44	0.239E-22	R(18) r
22	1170.650 17(4)	63.15	0.232E-22	R(12) r	57	1175.712 1	1450.78	0.338E-22	R(25) e
23	1170.657 33(8)*	2.51	0.157E-20	R(2) a	58	1175.755 30(8)*	30.17	0.415E-20	R(8) a
24	1171.243 79(3)	150.30	0.198E-22	R(19) t	59	1175.786 79(2)	717.26	0.561E-21	R(17) c
25	1171.267 19(2)	654.15	0.543E-21	R(12) b	60	1175.816 4	1420.00	0.505E-22	R(24) g
26	1171.335 1	1354.18	0.434E-22	R(20) e	61	1176.167 52(3)	257.06	0.155E-22	R(25) t
27	1171.415 46(2)	654.28	0.543E-21	R(12) c	62	1176.370 86(2)	732.11	0.553E-21	R(18) b
28	1171.482 81(3)	73.68	0.238E-22	R(13) r	63	1176.593 0	1472.61	0.316E-22	R(26) e
29	1171.497 9	1327.67	0.632E-22	R(19) g	64	1176.611 02(8)*	37.71	0.445E-20	R(9) a
30	1171.502 58(8)*	5.03	0.207E-20	R(3) a	65	1176.667 08(2)	732.38	0.552E-21	R(18) c
31	1172.061 84(3)	166.12	0.193E-22	R(20) t	66	1176.681 0	1440.98	0.474E-22	R(25) g
32	1172.116 18(2)	665.05	0.556E-21	R(13) b	67	1176.991 54(3)	277.62	0.147E-22	R(26) t
33	1172.206 9	1371.82	0.418E-22	R(21) e					
34	1172.285 64(2)	665.20	0.556E-21	R(13) c					
35	1172.349 61(8)*	8.38	0.255E-20	R(4) a					

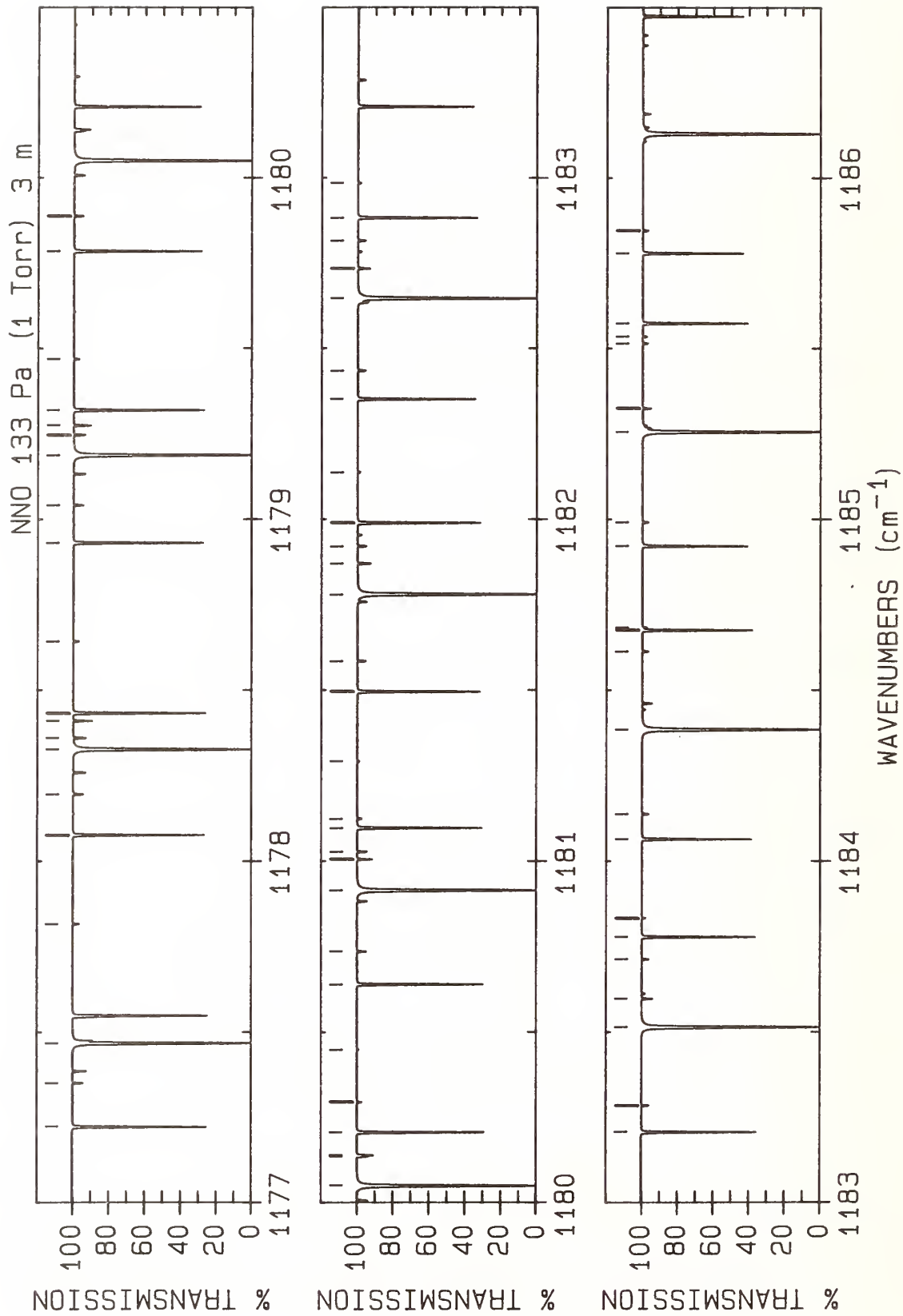

LINE #	WAVENUMBER(unc) (cm ⁻¹)	LOWER STATE (cm ⁻¹)	INTENSITY (cm/molecule)	ASSIGNMENT ROTATION BAND	LINE #	WAVENUMBER(unc) (cm ⁻¹)	LOWER STATE (cm ⁻¹)	INTENSITY (cm/molecule)	ASSIGNMENT ROTATION BAND
1	1177.223 62(2)	748.03	0.540E-21	R(19)	36	1181.584 63(3)	263.09	0.182E-22	R(25)
2	1177.352 17(3)	170.01	0.228E-22	R(20)	37	1181.779 85(8)*	100.55	0.531E-20	R(15)
3	1177.468 43(8)*	46.09	0.471E-20	R(10)	38	1181.870 0	1584.45	0.291E-22	R(31)
4	1177.816 46(3)	298.97	0.138E-22	R(27)	39	1181.920 7	1621.26	0.188E-22	R(32)
5	1178.076 95(2)	764.79	0.524E-21	R(20)	40	1181.989 17(2)	840.68	0.437E-21	R(24)
6	1178.196 16(3)	187.01	0.220E-22	R(21)	41	1182.137 40(9)*	1297.42	0.637E-23	R(5)
7	1178.327 50(8)*	55.31	0.492E-20	R(11)	42	1182.351 42(2)	861.16	0.413E-21	R(25)
8	1178.360 8	1518.81	0.272E-22	R(28)	43	1182.434 71(3)	284.13	0.171E-22	R(26)
9	1178.410 8	1485.45	0.412E-22	R(27)	44	1182.646 81(8)*	113.96	0.530E-20	R(16)
10	1178.433 53(2)	765.12	0.523E-21	R(20)	45	1182.734 3	1611.29	0.263E-22	R(32)
11	1178.642 23(3)	321.11	0.128E-22	R(28)	46	1182.815 9	1648.97	0.170E-22	R(33)
12	1178.930 83(2)	782.39	0.506E-21	R(21)	47	1182.882 67(2)	861.67	0.412E-21	R(25)
13	1179.041 43(3)	204.82	0.212E-22	R(22)	48	1182.984 22(9)*	1302.43	0.739E-23	R(6)
14	1179.188 20(8)*	65.36	0.509E-20	R(12)	49	1183.207 73(2)	882.94	0.387E-21	R(26)
15	1179.247 7	1543.16	0.250E-22	R(29)	50	1183.285 89(3)	305.98	0.160E-22	R(27)
16	1179.275 8	1508.94	0.380E-22	R(28)	51	1183.515 27(8)*	128.20	0.525E-20	R(17)
17	1179.319 63(2)	782.76	0.505E-21	R(21)	52	1183.598 2	1638.97	0.237E-22	R(33)
18	1179.468 82(3)	344.03	0.119E-22	R(29)	53	1183.713 3	1677.52	0.152E-22	R(34)
19	1179.785 24(2)	800.83	0.485E-21	R(22)	54	1183.777 95(2)	883.50	0.386E-21	R(26)
20	1179.887 96(3)	223.43	0.202E-22	R(23)	55	1183.832 75(9)*	1308.27	0.836E-23	R(7)
21	1180.050 51(8)*	76.25	0.521E-20	R(13)	56	1184.064 45(2)	905.56	0.361E-21	R(27)
22	1180.136 6	1568.36	0.229E-22	R(30)	57	1184.138 15(3)	328.64	0.149E-22	R(28)
23	1180.140 7	1533.28	0.350E-22	R(29)	58	1184.385 18(8)*	143.28	0.516E-20	R(18)
24	1180.207 63(2)	801.23	0.484E-21	R(22)	59	1184.612 8	1706.91	0.136E-22	R(35)
25	1180.296 21(3)	367.75	0.110E-22	R(30)	60	1184.674 97(2)	906.16	0.360E-21	R(27)
26	1180.448 95(9)*	1289.91	0.426E-23	R(3)	61	1184.682 97(9)*	1314.94	0.927E-23	R(8)
27	1180.640 16(2)	820.10	0.462E-21	R(23)	62	1184.921 57(2)	929.02	0.334E-21	R(28)
28	1180.735 70(3)	242.85	0.192E-22	R(24)	63	1184.991 44(3)	352.10	0.138E-22	R(29)
29	1180.914 40(8)*	87.98	0.528E-20	R(14)	64	1185.256 52(8)*	159.20	0.504E-20	R(19)
30	1181.005 4	1558.45	0.320E-22	R(30)	65	1185.324 8	1696.84	0.189E-22	R(35)
31	1181.027 6	1594.39	0.208E-22	R(31)	66	1185.514 5	1737.13	0.121E-22	R(36)
32	1181.097 48(2)	820.54	0.461E-21	R(23)	67	1185.534 87(9)*	1322.45	0.101E-22	R(9)
33	1181.124 35(3)	392.26	0.101E-22	R(31)	68	1185.573 71(2)	929.66	0.333E-21	R(28)
34	1181.292 30(9)*	1293.25	0.533E-23	R(4)	69	1185.779 07(2)	953.32	0.308E-21	R(29)
35	1181.495 56(2)	840.21	0.438E-21	R(24)	70	1185.845 72(3)	376.38	0.127E-22	R(30)

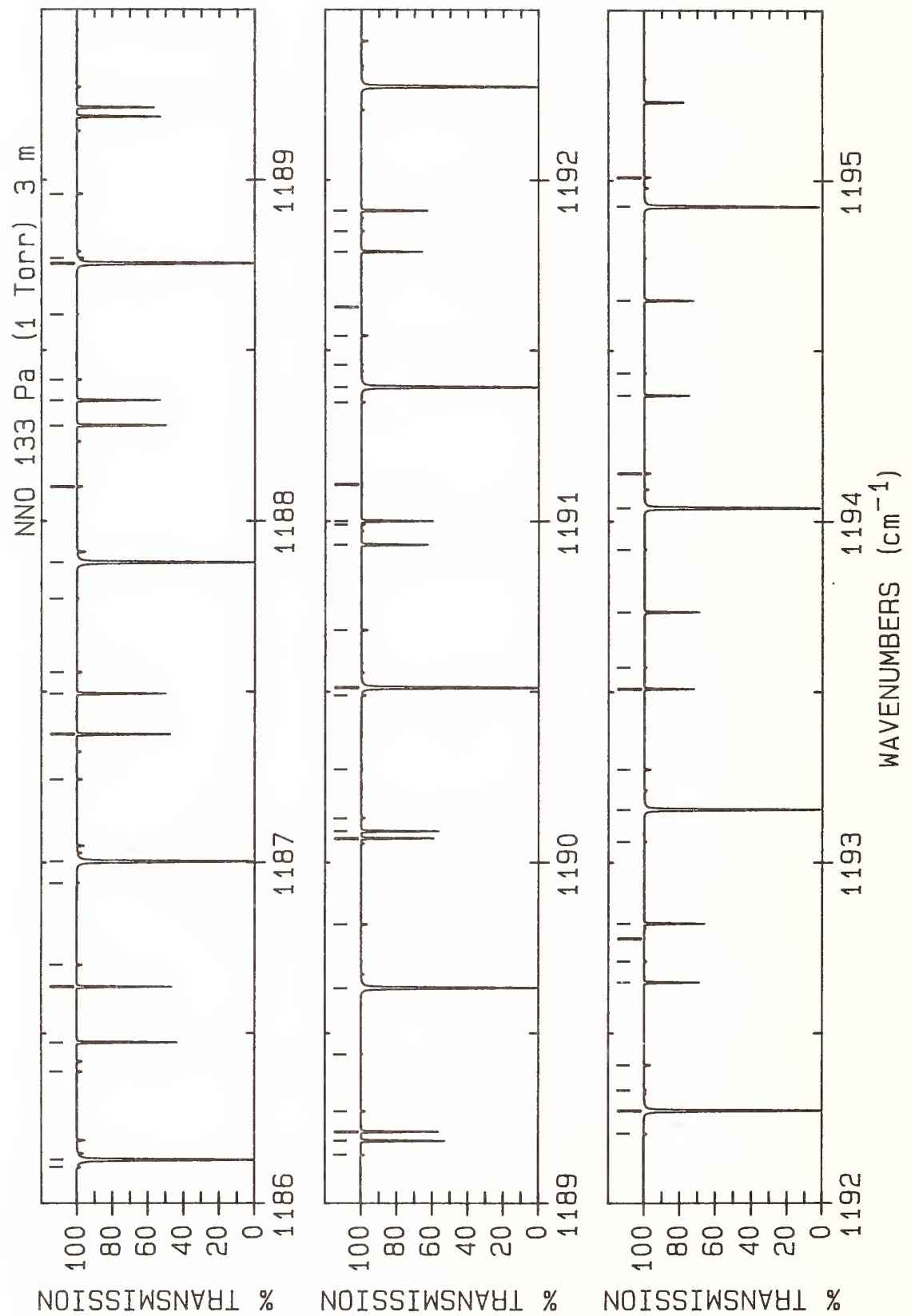

LINE #	WAVENUMBER(unc) (cm ⁻¹)	LOWER STATE (cm ⁻¹)	INTENSITY (cm/molecule)	ASSIGNMENT ROTATION BAND	LINE #	WAVENUMBER(unc) (cm ⁻¹)	LOWER STATE (cm ⁻¹)	INTENSITY (cm/molecule)	ASSIGNMENT ROTATION BAND
1	1186.107 05(3)	555.87	0.555E-23	R(37) t	36	1190.680 09(8)*	1385.04	0.135E-22	R(15) d
2	1186.129 23(8)*	175.95	0.489E-20	R(20) a	37	1190.930 50(2)	1116.65	0.171E-21	R(35) b
3	1186.388 41(9)*	1330.80	0.109E-22	R(10) d	38	1190.989 94(3)	538.98	0.701E-23	R(36) r
4	1186.474 14(2)	954.01	0.307E-21	R(29) c	39	1191.000 37(2)	1088.28	0.190E-21	R(34) c
5	1186.636 91(2)	978.45	0.283E-21	R(30) b	40	1191.107 51(3)	747.87	0.259E-23	R(43) t
6	1186.700 95(3)	401.46	0.116E-22	R(31) r	41	1191.347 8	1925.71	0.740E-23	R(42) g
7	1186.939 46(3)	585.90	0.494E-23	R(38) t	42	1191.392 41(8)*	294.06	0.360E-20	R(26) a
8	1187.003 30(8)*	193.54	0.472E-20	R(21) a	43	1191.457 26(4)	100.55	0.358E-23	R(15) x
9	1187.243 59(9)*	1339.98	0.116E-22	R(11) d	44	1191.543 03(8)*	1398.38	0.138E-22	R(16) d
10	1187.376 22(2)	979.18	0.282E-21	R(30) c	45	1191.627 37(5)	1592.40	0.819E-24	P(63) T
11	1187.495 08(2)	1004.42	0.258E-21	R(31) b	46	1191.789 91(2)	1146.80	0.153E-21	R(36) b
12	1187.557 10(3)	427.35	0.106E-22	R(32) r	47	1191.850 00(3)	568.91	0.625E-23	R(37) r
13	1187.772 32(3)	616.72	0.438E-23	R(39) t	48	1191.910 18(2)	1117.64	0.170E-21	R(35) c
14	1187.878 67(8)*	211.97	0.452E-20	R(22) a	49	1192.205 1	1961.75	0.635E-23	R(43) g
15	1188.100 37(9)*	1349.99	0.122E-22	R(12) d	50	1192.273 69(8)*	316.67	0.336E-20	R(27) a
16	1188.279 92(2)	1005.20	0.258E-21	R(31) c	51	1192.333 68(4)	113.96	0.452E-23	R(16) x
17	1188.353 55(2)	1031.22	0.235E-21	R(32) b	52	1192.407 44(8)*	1412.57	0.140E-22	R(17) d
18	1188.414 11(3)	454.04	0.964E-23	R(33) r	53	1192.649 50(2)	1177.78	0.135E-21	R(37) b
19	1188.605 59(3)	648.32	0.386E-23	R(40) t	54	1192.710 72(3)	599.64	0.554E-23	R(38) r
20	1188.755 31(8)*	231.24	0.431E-20	R(23) a	55	1192.776 78(4)	818.17	0.194E-23	R(45) t
21	1188.770 9	1822.61	0.114E-22	R(39) g	56	1192.821 42(2)	1147.85	0.152E-21	R(36) c
22	1188.958 73(8)*	1360.84	0.128E-22	R(13) d	57	1193.061 4	1998.62	0.543E-23	R(44) g
23	1189.143 3	1866.41	0.715E-23	R(40) e	58	1193.156 02(8)*	340.12	0.311E-20	R(28) a
24	1189.185 20(2)	1032.06	0.234E-21	R(32) c	59	1193.273 27(9)*	1427.58	0.140E-22	R(18) d
25	1189.212 29(2)	1058.86	0.212E-21	R(33) b	60	1193.509 23(2)	1209.60	0.119E-21	R(38) b
26	1189.271 95(3)	481.55	0.871E-23	R(34) r	61	1193.572 04(3)	631.18	0.489E-23	R(39) r
27	1189.439 25(3)	680.72	0.339E-23	R(41) t	62	1193.734 06(2)	1178.89	0.135E-21	R(37) c
28	1189.633 17(8)*	251.34	0.408E-20	R(24) a	63	1193.916 8	2036.33	0.461E-23	R(45) g
29	1189.818 65(8)*	1372.52	0.132E-22	R(14) d	64	1194.039 35(8)*	364.41	0.287E-20	R(29) a
30	1190.071 28(2)	1087.34	0.191E-21	R(34) b	65	1194.140 51(9)*	1443.43	0.140E-22	R(19) d
31	1190.092 03(2)	1059.75	0.212E-21	R(33) c	66	1194.369 09(2)	1242.25	0.105E-21	R(39) b
32	1190.130 58(3)	509.86	0.783E-23	R(35) r	67	1194.433 92(3)	663.53	0.430E-23	R(40) r
33	1190.273 23(3)	713.90	0.297E-23	R(42) t	68	1194.648 04(2)	1210.77	0.119E-21	R(38) c
34	1190.489 7	1890.51	0.858E-23	R(41) g	69	1194.923 64(8)*	389.53	0.263E-20	R(30) a
35	1190.512 22(8)*	272.28	0.384E-20	R(25) a	70	1195.009 10(9)*	1460.12	0.139E-22	R(20) d

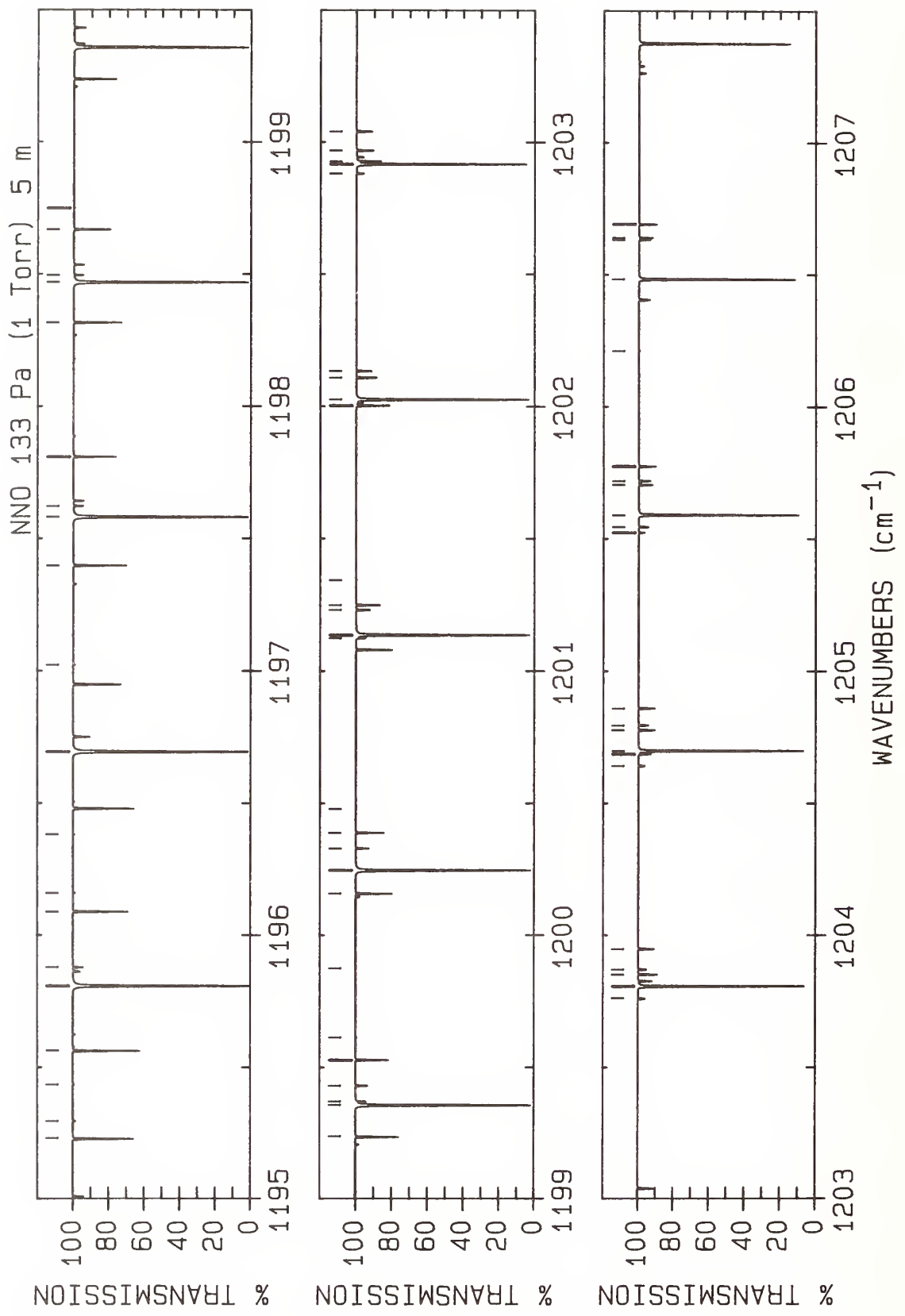

LINE #	WAVENUMBER(unc) (cm ⁻¹)	LOWER STATE (cm ⁻¹)	INTENSITY (cm/molecule)	ASSIGNMENT ROTATION BAND	LINE #	WAVENUMBER(unc) (cm ⁻¹)	LOWER STATE (cm ⁻¹)	INTENSITY (cm/molecule)	ASSIGNMENT ROTATION BAND
1	1195.229 03(2)	1275.74	0.919E-22	R(40) b	36	1201.230 64(4)	294.06	0.183E-22	R(26) x
2	1195.296 32(3)	696.68	0.376E-23	R(41) r	37	1201.248 96(2)	1533.53	0.318E-22	R(47) b
3	1195.435 34(5)	1398.36	0.198E-23	P(59) T	38	1201.343 82(5)	951.32	0.131E-23	R(48) r
4	1195.563 34(2)	1243.48	0.104E-21	R(39) c	39	1202.002 19(9)*	1623.60	0.106E-22	R(28) d
5	1195.808 83(8)*	415.49	0.240E-20	R(31) a	40	1202.003 31(2)	1495.90	0.371E-22	R(46) c
6	1195.879 02(9)*	1477.64	0.136E-22	R(21) d	41	1202.026 31(8)*	620.59	0.110E-20	R(38) a
7	1196.089 04(2)	1310.06	0.800E-22	R(41) b	42	1202.108 67(3)	1573.69	0.268E-22	R(48) b
8	1196.159 19(3)	730.64	0.328E-23	R(42) r	43	1202.134 09(4)	316.67	0.196E-22	R(27) x
9	1196.381 84(5)	1351.81	0.244E-23	P(58) T	44	1202.881 23(9)*	1647.79	0.997E-23	R(29) d
10	1196.694 87(8)*	442.28	0.218E-20	R(32) a	45	1202.916 93(8)*	653.23	0.969E-21	R(39) a
11	1197.022 49(4)	765.40	0.284E-23	R(43) r	46	1202.927 44(3)	1535.31	0.315E-22	R(47) c
12	1197.397 68(2)	1311.42	0.795E-22	R(41) c	47	1202.968 23(3)	1614.68	0.225E-22	R(49) b
13	1197.581 72(8)*	469.91	0.197E-20	R(33) a	48	1203.040 16(4)	340.12	0.207E-22	R(28) x
14	1197.622 68(9)*	1515.18	0.130E-22	R(23) d	49	1203.761 20(9)*	1672.80	0.936E-23	R(30) d
15	1197.809 15(2)	1381.21	0.599E-22	R(43) b	50	1203.808 00(8)*	686.70	0.847E-21	R(40) a
16	1198.316 64(2)	1346.65	0.689E-22	R(42) c	51	1203.852 45(3)	1575.55	0.265E-22	R(48) c
17	1198.469 33(8)*	498.37	0.177E-20	R(34) a	52	1203.871 02(3)	1007.69	0.112E-22	P(50) T
18	1198.496 34(9)*	1535.19	0.126E-22	R(24) d	53	1203.948 84(4)	364.41	0.218E-22	R(29) x
19	1198.669 20(2)	1418.04	0.515E-22	R(44) b	54	1204.642 07(9)*	1698.65	0.875E-23	R(31) d
20	1198.750 19(4)	837.35	0.211E-23	R(45) r	55	1204.686 76(3)	1699.17	0.157E-22	R(51) b
21	1199.236 73(2)	1382.71	0.594E-22	R(43) c	56	1204.699 47(8)*	721.01	0.737E-21	R(41) a
22	1199.357 65(8)*	527.67	0.159E-20	R(35) a	57	1204.778 30(3)	1616.62	0.223E-22	R(49) c
23	1199.371 17(9)*	1556.05	0.122E-22	R(25) d	58	1204.796 49(3)	968.22	0.134E-22	P(49) T
24	1199.431 42(4)	251.34	0.154E-22	R(24) x	59	1204.860 19(4)	389.53	0.226E-22	R(30) x
25	1199.529 20(2)	1455.70	0.440E-22	R(45) b	60	1205.523 78(9)*	1725.33	0.814E-23	R(32) d
26	1199.614 50(4)	874.54	0.181E-23	R(46) r	61	1205.545 69(3)	1742.67	0.130E-22	R(52) b
27	1199.875 7	2323.60	0.131E-23	R(52) g	62	1205.591 28(8)*	756.16	0.638E-21	R(42) a
28	1200.157 91(2)	1419.61	0.510E-22	R(44) c	63	1205.704 93(3)	1658.53	0.186E-22	R(50) c
29	1200.246 61(8)*	557.81	0.141E-20	R(36) a	64	1205.719 52(3)	929.52	0.158E-22	P(48) T
30	1200.247 11(9)*	1577.73	0.117E-22	R(26) d	65	1205.774 21(3)	415.49	0.233E-22	R(31) x
31	1200.329 75(4)	272.28	0.169E-22	R(25) x	66	1206.210 75(6)*	2775.30	0.175E-23	P(81) A
32	1200.389 13(2)	1494.20	0.375E-22	R(46) b	67	1206.483 39(8)*	792.14	0.550E-21	R(43) a
33	1200.479 06(4)	912.53	0.154E-23	R(47) r	68	1206.632 28(3)	1701.27	0.155E-22	R(51) c
34	1201.124 13(9)*	1600.25	0.111E-22	R(27) d	69	1206.640 10(3)	891.62	0.186E-22	P(47) T
35	1201.136 18(8)*	588.78	0.125E-20	R(37) a	70	1206.690 95(3)	442.28	0.238E-22	R(32) x

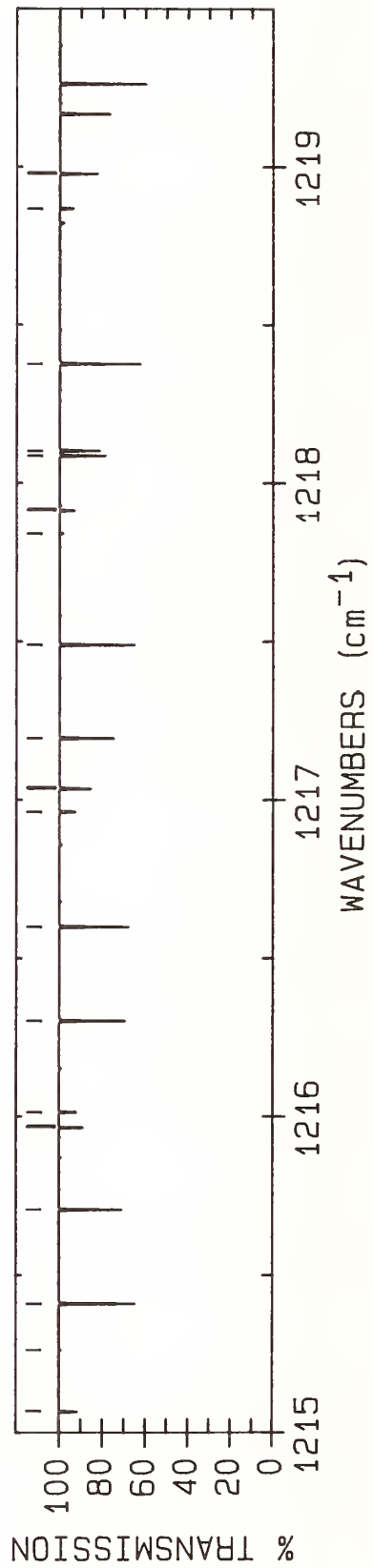
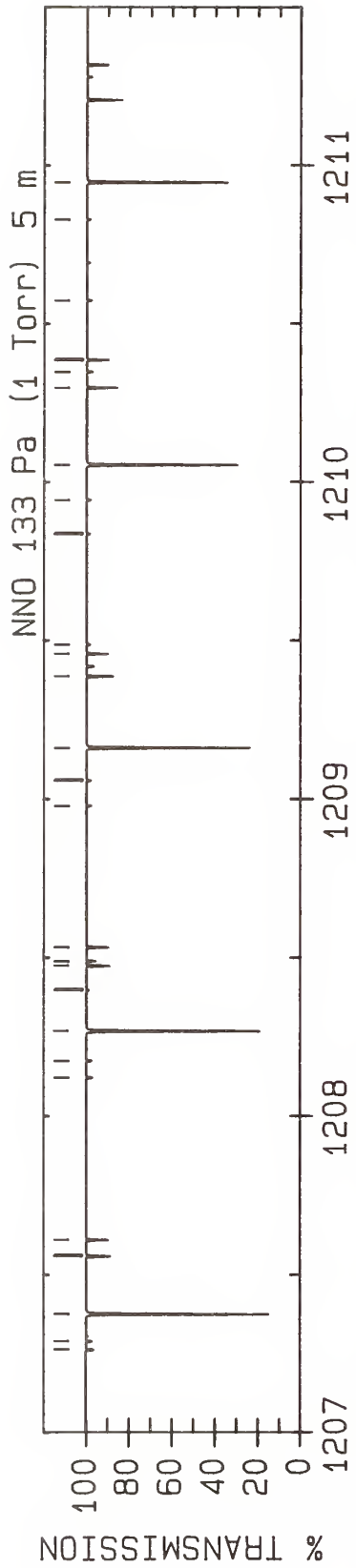

LINE #	WAVENUMBER(unc) (cm ⁻¹)	LOWER STATE (cm ⁻¹)	INTENSITY (cm/molecule)	ASSIGNMENT ROTATION BAND	LINE #	WAVENUMBER(unc) (cm ⁻¹)	LOWER STATE (cm ⁻¹)	INTENSITY (cm/molecule)	ASSIGNMENT ROTATION BAND
1	1207.262 72(3)	1832.15	0.884E-23	R(54) b	36	1212.405 26(3)	2120.57	0.249E-23	R(60) b
2	1207.289 51(9)*	1781.19	0.694E-23	R(34) d	37	1212.601 60(9)*	1968.74	0.385E-23	R(40) d
3	1207.375 75(8)*	828.95	0.472E-21	R(44) a	38	1212.732 28(8)*	1067.33	0.171E-21	R(50) a
4	1207.558 20(3)	854.50	0.219E-22	P(46) T	39	1212.738 47(5)*	2382.64	0.110E-22	P(75) A
5	1207.560 31(3)	1744.84	0.129E-22	R(52) c	40	1213.013 84(3)	648.32	0.520E-22	P(40) T
6	1207.610 43(3)	469.91	0.240E-22	R(33) x	41	1213.186 33(3)	653.23	0.216E-22	R(39) x
7	1208.120 77(3)	1878.14	0.723E-23	R(55) b	42	1213.488 56(9)*	2002.90	0.343E-23	R(41) d
8	1208.173 44(9)*	1810.37	0.637E-23	R(35) d	43	1213.624 99(8)*	1109.98	0.142E-21	R(51) a
9	1208.268 30(8)*	866.60	0.403E-21	R(45) a	44	1213.816 76(5)*	2320.08	0.148E-22	P(74) A
10	1208.397 56(6)*	2641.11	0.329E-23	P(79) A	45	1213.914 13(3)	616.72	0.592E-22	P(39) T
11	1208.473 80(3)	818.17	0.255E-22	P(45) T	46	1214.125 75(3)	686.70	0.207E-22	R(40) x
12	1208.488 95(3)	1789.25	0.106E-22	R(53) c	47	1214.375 84(9)*	2037.90	0.304E-23	R(42) d
13	1208.532 67(3)	498.37	0.241E-22	R(34) x	48	1214.517 56(8)*	1153.46	0.118E-21	R(52) a
14	1208.978 47(3)	1924.97	0.590E-23	R(56) b	49	1214.811 83(3)	585.90	0.670E-22	P(38) T
15	1209.058 01(9)*	1840.38	0.581E-23	R(36) d	50	1214.892 23(5)*	2258.36	0.197E-22	P(73) A
16	1209.161 00(8)*	905.08	0.343E-21	R(46) a	51	1215.068 12(3)	721.01	0.197E-22	R(41) x
17	1209.386 90(3)	782.62	0.297E-22	P(44) T	52	1215.263 39(9)*	2073.73	0.269E-23	R(43) d
18	1209.457 70(3)	527.67	0.239E-22	R(35) x	53	1215.409 96(8)*	1197.77	0.970E-22	R(53) a
19	1209.486 91(6)*	2575.26	0.448E-23	P(78) A	54	1215.706 90(3)	555.87	0.756E-22	P(37) T
20	1209.835 80(3)	1972.62	0.478E-23	R(57) b	55	1215.964 86(5)*	2197.45	0.261E-22	P(72) A
21	1209.943 16(9)*	1871.22	0.528E-23	R(37) d	56	1216.013 47(3)	756.16	0.185E-22	R(42) x
22	1210.053 79(8)*	944.39	0.290E-21	R(47) a	57	1216.302 14(8)*	1242.91	0.796E-22	R(54) a
23	1210.297 46(3)	747.87	0.344E-22	P(43) T	58	1216.599 35(3)	526.63	0.848E-22	P(36) T
24	1210.347 87(3)	1880.57	0.712E-23	R(55) c	59	1216.961 82(3)	792.14	0.173E-22	R(43) x
25	1210.385 56(3)	557.81	0.236E-22	R(36) x	60	1217.034 64(5)*	2137.38	0.346E-22	P(71) A
26	1210.573 52(6)*	2510.22	0.607E-23	P(77) A	61	1217.039 07(10)*	2147.88	0.207E-23	R(45) d
27	1210.828 84(9)*	1902.90	0.477E-23	R(38) d	62	1217.194 05(8)*	1288.88	0.651E-22	R(55) a
28	1210.946 63(8)*	984.54	0.244E-21	R(48) a	63	1217.489 14(3)	498.18	0.948E-22	P(35) T
29	1211.205 49(3)	713.90	0.396E-22	P(42) T	64	1217.840 86(8)	1383.51	0.408E-23	P(58) R
30	1211.316 26(3)	588.78	0.231E-22	R(37) x	65	1217.913 20(3)	828.95	0.161E-22	R(44) x
31	1211.657 38(6)*	2446.02	0.820E-23	P(76) A	66	1218.085 67(8)*	1335.69	0.529E-22	R(56) a
32	1211.715 01(9)*	1935.40	0.429E-23	R(39) d	67	1218.101 55(5)*	2078.13	0.455E-22	P(70) A
33	1211.839 48(8)*	1025.52	0.205E-21	R(49) a	68	1218.376 28(3)	470.51	0.105E-21	P(34) T
34	1212.110 95(3)	680.72	0.455E-22	P(41) T	69	1218.867 63(3)	866.60	0.149E-22	R(45) x
35	1212.249 85(3)	620.59	0.225E-22	R(38) x	70	1218.976 94(8)*	1383.33	0.429E-22	R(57) a

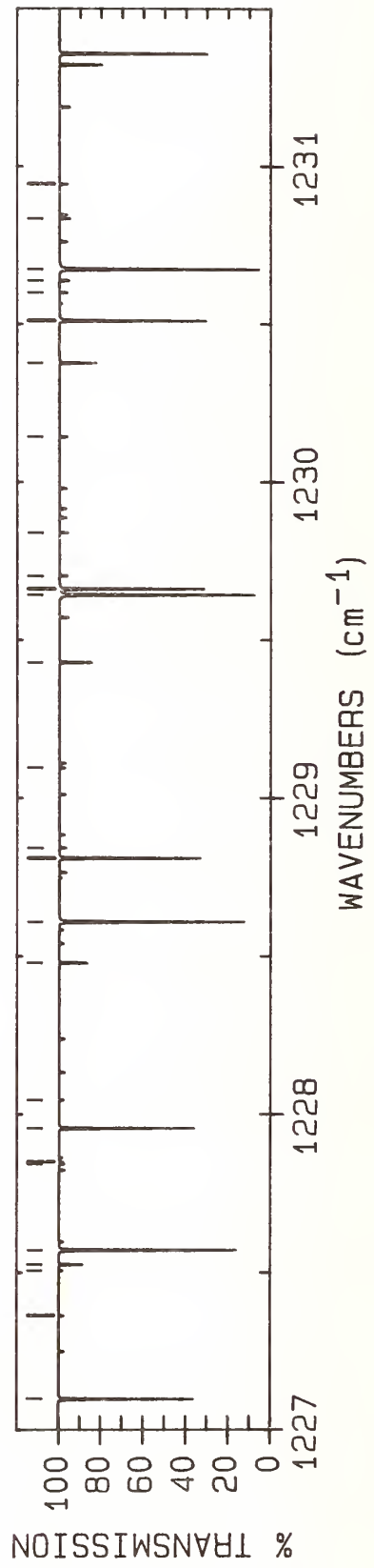
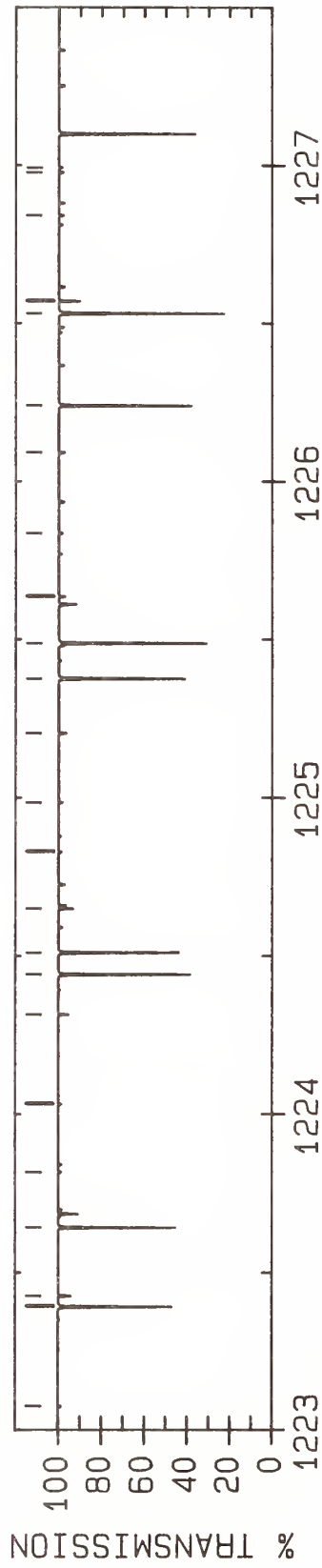
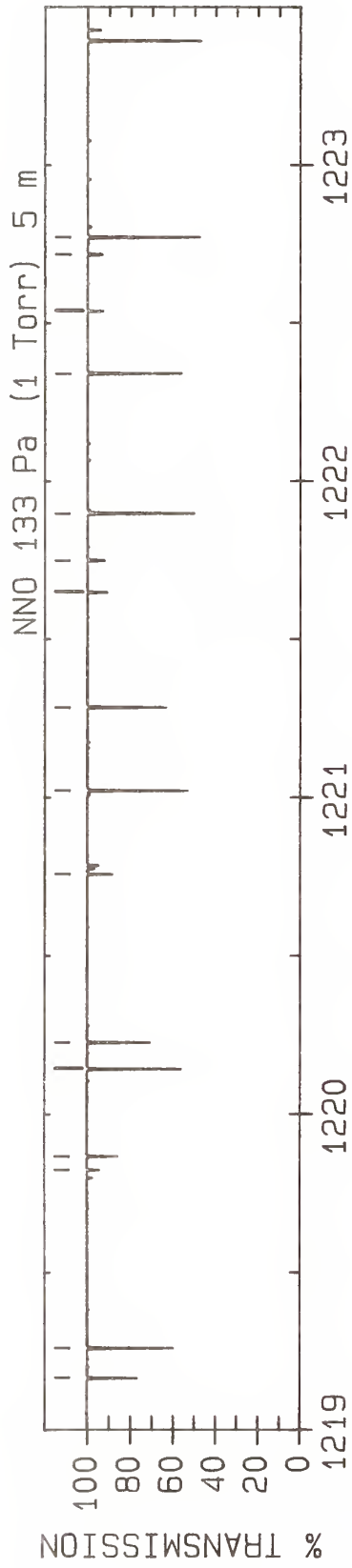

LINE #	WAVENUMBER(unc) (cm ⁻¹)	LOWER STATE (cm ⁻¹)	INTENSITY (cm/molecule)	ASSIGNMENT ROTATION BAND	LINE #	WAVENUMBER(unc) (cm ⁻¹)	LOWER STATE (cm ⁻¹)	INTENSITY (cm/molecule)	ASSIGNMENT ROTATION BAND
1	1219.165 56(5)*	2019.71	0.597E-22	P(69) A	36	1225.836 11(8)*	2662.47	0.439E-23	P(57) D
2	1219.260 74(3)	443.64	0.117E-21	P(33) T	37	1226.090 55(9)*	1794.32	0.679E-23	R(65) a
3	1219.825 13(3)	905.08	0.137E-22	R(46) x	38	1226.238 88(3)	257.06	0.220E-21	P(25) T
4	1219.867 84(9)*	1431.79	0.346E-22	R(58) a	39	1226.531 24(5)*	1633.97	0.353E-21	P(62) A
5	1220.142 52(3)	417.55	0.128E-21	P(32) T	40	1226.570 25(8)	990.92	0.228E-22	P(49) R
6	1220.226 66(5)*	1962.12	0.779E-22	P(68) A	41	1226.841 02(8)*	2615.03	0.543E-23	P(56) D
7	1220.758 31(9)*	1481.09	0.277E-22	R(59) a	42	1226.977 18(9)*	1849.42	0.529E-23	R(66) a
8	1221.021 61(3)	392.26	0.141E-21	P(31) T	43	1226.992 38(6)*	2551.62	0.433E-23	P(68) B
9	1221.284 84(5)*	1905.36	0.101E-21	P(67) A	44	1227.098 78(3)	237.29	0.233E-21	P(24) T
10	1221.648 34(9)*	1531.22	0.222E-22	R(60) a	45	1227.363 8	1055.80	0.617E-23	P(34) Z
11	1221.748 41(8)	1200.98	0.914E-23	P(54) R	46	1227.507 15(6)*	2555.32	0.433E-23	P(68) C
12	1221.749 42(4)	984.54	0.113E-22	R(48) x	47	1227.526 15(7)	951.32	0.270E-22	P(48) R
13	1221.897 99(3)	367.75	0.154E-21	P(30) T	48	1227.571 52(5)*	1582.18	0.447E-21	P(61) A
14	1222.340 07(5)*	1849.42	0.131E-21	P(66) A	49	1227.843 33(8)*	2568.41	0.669E-23	P(55) D
15	1222.537 88(9)*	1582.18	0.177E-22	R(61) a	50	1227.849 71(8)	1335.59	0.526E-23	P(56) P
16	1222.716 25(4)	1025.52	0.102E-22	R(49) x	51	1227.955 91(3)	218.31	0.245E-21	P(23) T
17	1222.718 39(8)	1157.36	0.111E-22	P(53) R	52	1228.045 37(6)*	2494.84	0.564E-23	P(67) B
18	1222.771 65(3)	344.03	0.167E-21	P(29) T	53	1228.479 19(7)	912.53	0.318E-22	P(47) R
19	1223.076 37(5)	916.61	0.325E-23	P(47) V	54	1228.608 76(5)*	1531.22	0.564E-21	P(60) A
20	1223.392 34(5)*	1794.32	0.169E-21	P(65) A	55	1228.810 25(3)	200.12	0.256E-21	P(22) T
21	1223.426 91(9)*	1633.97	0.140E-22	R(62) a	56	1228.843 01(8)*	2522.63	0.820E-23	P(54) D
22	1223.642 58(3)	321.11	0.180E-21	P(28) T	57	1229.095 48(6)*	2438.88	0.731E-23	P(66) B
23	1223.816 27(6)*	2726.94	0.192E-23	P(71) B	58	1229.429 37(7)	874.54	0.374E-22	P(46) R
24	1223.818 56(8)*	2759.83	0.283E-23	P(59) D	59	1229.642 96(5)*	1481.09	0.708E-21	P(59) A
25	1224.031 75(5)	878.45	0.384E-23	P(46) V	60	1229.661 78(2)	182.72	0.266E-21	P(21) T
26	1224.315 38(9)*	1686.59	0.110E-22	R(63) a	61	1229.703 18(4)	666.49	0.940E-23	P(40) V
27	1224.441 64(5)*	1740.04	0.217E-21	P(64) A	62	1229.840 03(7)*	2477.68	0.100E-22	P(53) D
28	1224.510 76(3)	298.97	0.194E-21	P(27) T	63	1230.142 69(6)*	2383.76	0.943E-23	P(65) B
29	1224.649 95(8)	1072.53	0.160E-22	P(51) R	64	1230.376 68(7)	837.35	0.438E-22	P(45) R
30	1224.828 61(8)*	2710.73	0.353E-23	P(58) D	65	1230.510 51(2)	166.12	0.275E-21	P(20) T
31	1224.984 25(4)	841.10	0.450E-23	P(45) V	66	1230.600 07(6)*	2387.14	0.942E-23	P(65) C
32	1225.203 27(9)*	1740.04	0.868E-23	R(64) a	67	1230.638 16(4)	634.00	0.107E-22	P(39) V
33	1225.376 20(3)	277.62	0.207E-21	P(26) T	68	1230.674 10(5)*	1431.79	0.886E-21	P(58) A
34	1225.487 94(5)*	1686.59	0.277E-21	P(63) A	69	1230.834 37(7)*	2433.55	0.122E-22	P(52) D
35	1225.635 62(4)	1153.46	0.712E-23	R(52) x	70	1230.943 57(7)	1197.68	0.978E-23	P(53) P

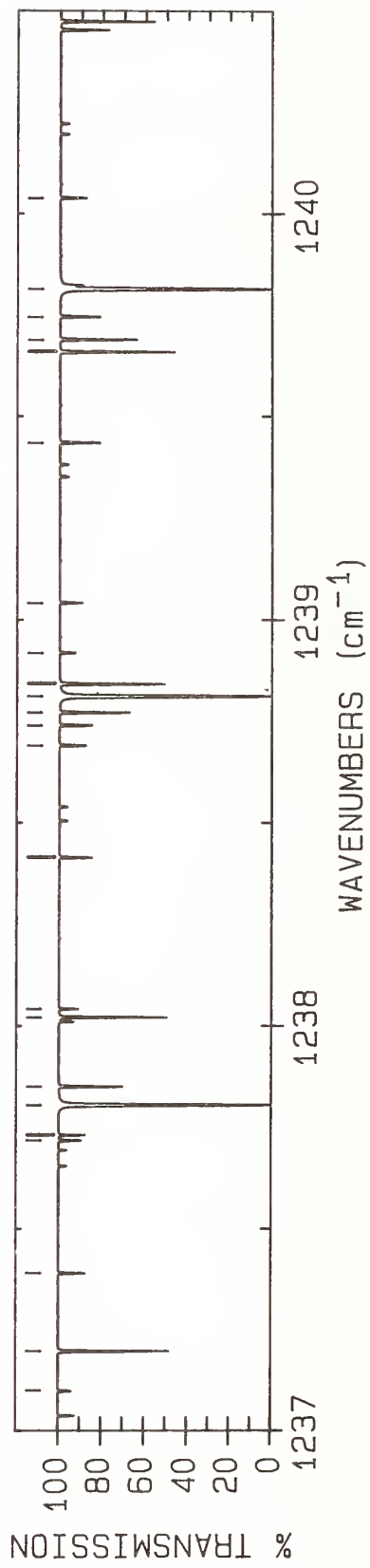
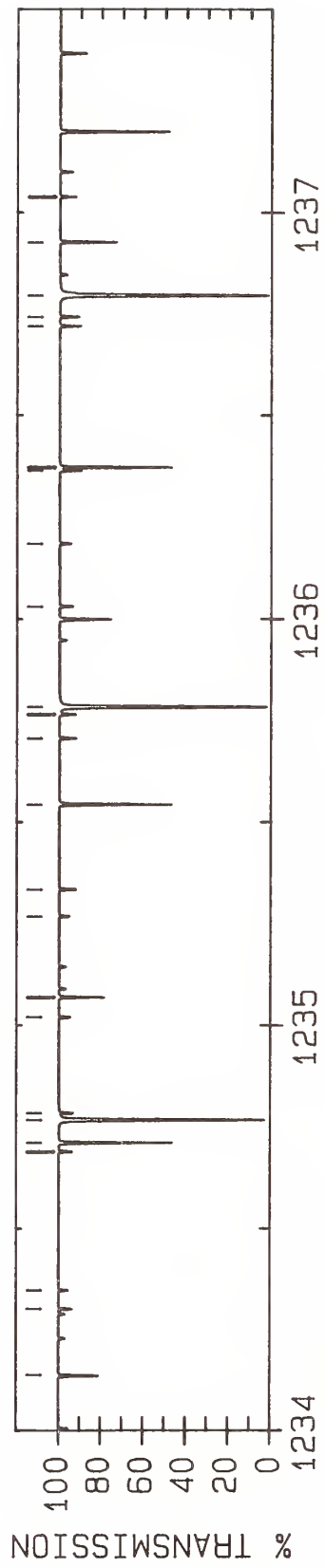
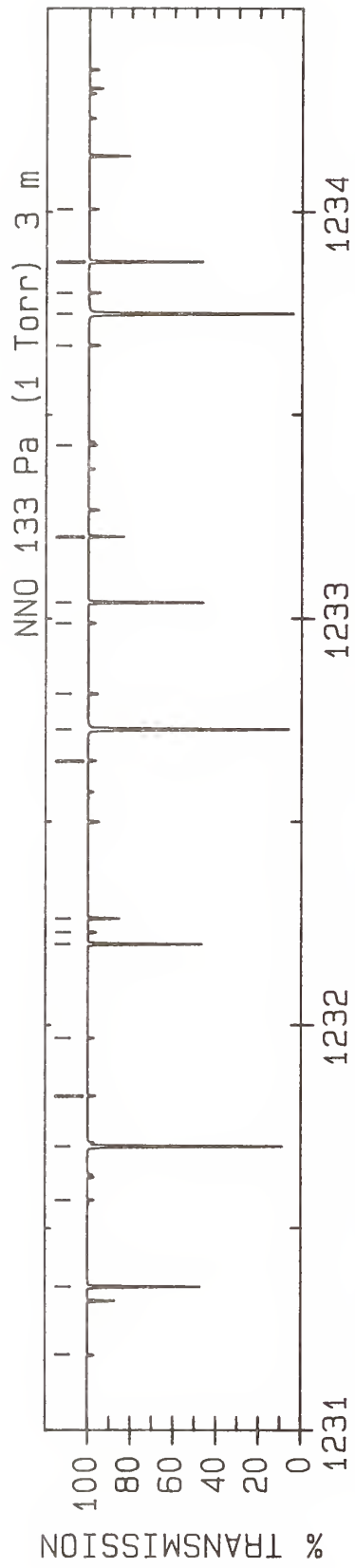

LINE #	WAVENUMBER(unc) (cm ⁻¹)	LOWER STATE (cm ⁻¹)	INTENSITY (cm/molecule)	ASSIGNMENT ROTATION BAND	LINE #	WAVENUMBER(unc) (cm ⁻¹)	LOWER STATE (cm ⁻¹)	INTENSITY (cm/molecule)	ASSIGNMENT ROTATION BAND
1	1231.187 00(6)*	2329.46	0.121E-22	P(64)	36	1235.783 39(5)*	1197.77	0.254E-20	P(53)
2	1231.356 43(3)	150.30	0.282E-21	P(19)	37	1236.031 03(6)	984.47	0.251E-22	P(48)
3	1231.570 18(5)	602.32	0.122E-22	P(38)	38	1236.185 46(5)	456.08	0.217E-22	P(33)
4	1231.702 15(5)*	1383.33	0.110E-20	P(57)	39	1236.364 40(6)*	2070.42	0.397E-22	P(59)
5	1231.826 01(7)*	2390.25	0.147E-22	P(51)	40	1236.372 36(3)	71.99	0.284E-21	P(13)
6	1231.967 98(7)	1153.37	0.119E-22	P(52)	41	1236.719 88(6)*	2073.21	0.397E-22	P(59)
7	1232.199 52(3)	135.27	0.288E-21	P(18)	42	1236.742 87(7)*	2186.20	0.359E-22	P(46)
8	1232.228 38(6)*	2275.99	0.155E-22	P(63)	43	1236.795 89(5)*	1153.46	0.309E-20	P(52)
9	1232.262 63(7)	765.40	0.592E-22	P(43)	44	1236.926 49(7)	599.64	0.116E-21	P(38)
10	1232.649 95(6)*	2279.17	0.155E-22	P(63)	45	1237.038 13(6)	944.33	0.300E-22	P(47)
11	1232.727 13(5)*	1335.69	0.137E-20	P(56)	46	1237.099 48(5)	429.26	0.240E-22	P(32)
12	1232.814 92(7)*	2347.78	0.178E-22	P(50)	47	1237.198 36(3)	61.71	0.275E-21	P(12)
13	1232.988 93(7)	1109.90	0.145E-22	P(51)	48	1237.390 97(6)*	2021.11	0.497E-22	P(58)
14	1233.039 78(3)	121.03	0.292E-21	P(17)	49	1237.717 84(7)*	2147.88	0.422E-22	P(45)
15	1233.201 25(7)	730.64	0.683E-22	P(42)	50	1237.731 03(6)*	2023.80	0.497E-22	P(58)
16	1233.425 29(5)	541.39	0.156E-22	P(36)	51	1237.805 24(5)*	1109.98	0.375E-20	P(51)
17	1233.671 19(6)*	2226.43	0.197E-22	P(62)	52	1237.850 45(6)	568.91	0.131E-21	P(37)
18	1233.749 00(5)*	1288.88	0.169E-20	P(55)	53	1238.021 48(3)	52.21	0.265E-21	P(11)
19	1233.801 08(7)*	2306.14	0.213E-22	P(49)	54	1238.041 74(6)	905.01	0.356E-22	P(46)
20	1233.877 20(3)	107.58	0.293E-21	P(16)	55	1238.414 54(6)*	1972.62	0.620E-22	P(57)
21	1234.006 43(7)	1067.26	0.175E-22	P(50)	56	1238.689 96(7)*	2110.39	0.496E-22	P(44)
22	1234.136 96(7)	696.68	0.785E-22	P(41)	57	1238.739 60(6)*	1975.23	0.619E-22	P(57)
23	1234.302 32(6)*	2171.55	0.250E-22	P(61)	58	1238.771 43(6)	538.98	0.147E-21	P(36)
24	1234.348 35(5)	512.14	0.175E-22	P(35)	59	1238.811 43(5)*	1067.33	0.453E-20	P(50)
25	1234.689 94(6)*	2174.53	0.250E-22	P(61)	60	1238.841 72(3)	43.51	0.251E-21	P(10)
26	1234.711 78(3)	94.93	0.292E-21	P(15)	61	1238.918 41(4)	378.06	0.289E-22	P(30)
27	1234.767 76(5)*	1242.91	0.208E-20	P(54)	62	1239.041 86(6)	866.54	0.420E-22	P(45)
28	1234.784 47(7)*	2265.33	0.255E-22	P(48)	63	1239.435 10(6)*	1924.97	0.769E-22	P(56)
29	1235.020 47(6)	1025.45	0.210E-22	P(49)	64	1239.659 08(3)	35.60	0.235E-21	P(9)
30	1235.069 74(7)	663.53	0.898E-22	P(40)	65	1239.659 21(7)*	2073.73	0.579E-22	P(43)
31	1235.268 41(5)	483.70	0.195E-22	P(34)	66	1239.689 45(6)	509.86	0.165E-21	P(35)
32	1235.334 85(6)*	2120.57	0.316E-22	P(60)	67	1239.745 58(6)*	1927.48	0.768E-22	P(56)
33	1235.543 50(3)	83.06	0.289E-21	P(14)	68	1239.814 45(5)*	1025.52	0.544E-20	P(49)
34	1235.706 18(6)*	2123.45	0.316E-22	P(60)	69	1240.038 50(6)	828.89	0.494E-22	P(44)
35	1235.765 08(7)*	2225.35	0.303E-22	P(47)					

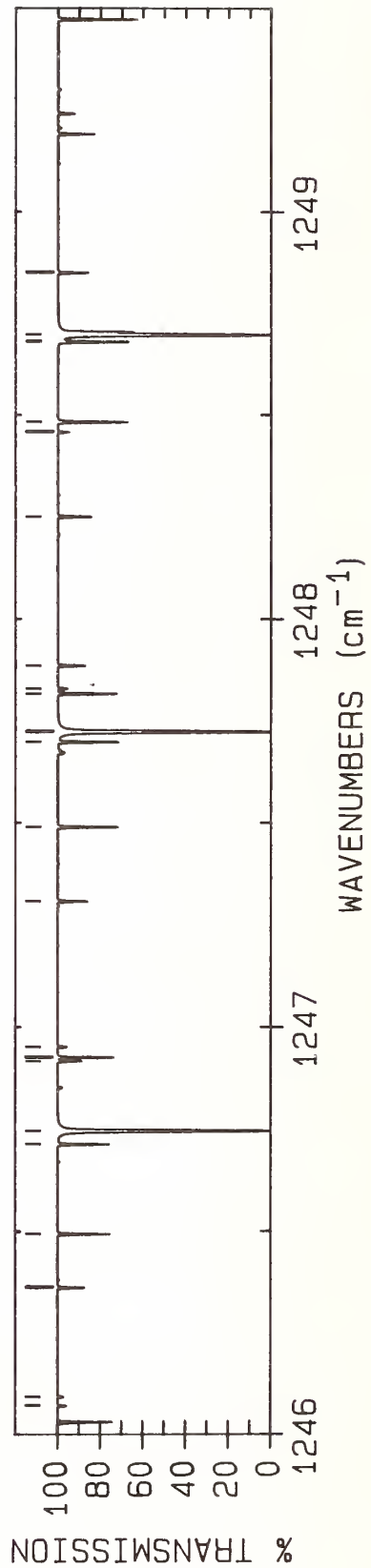
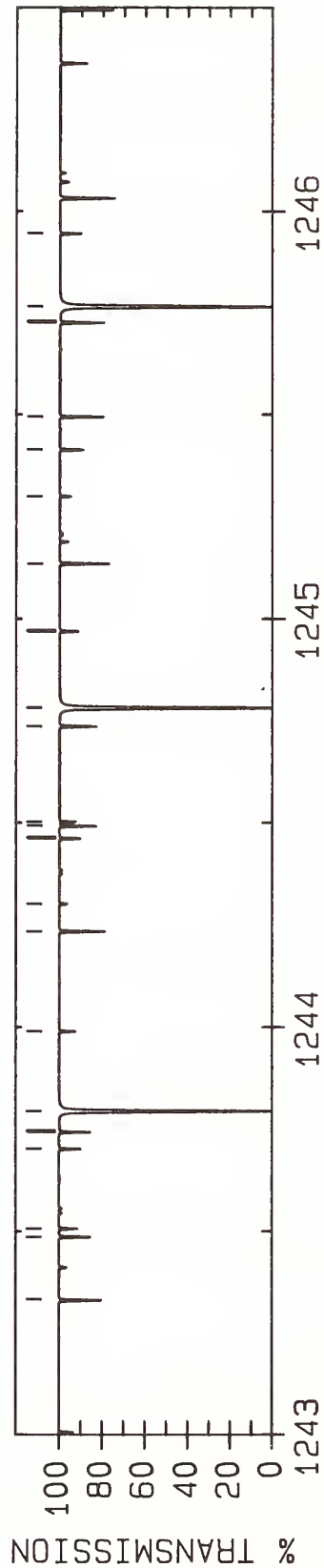
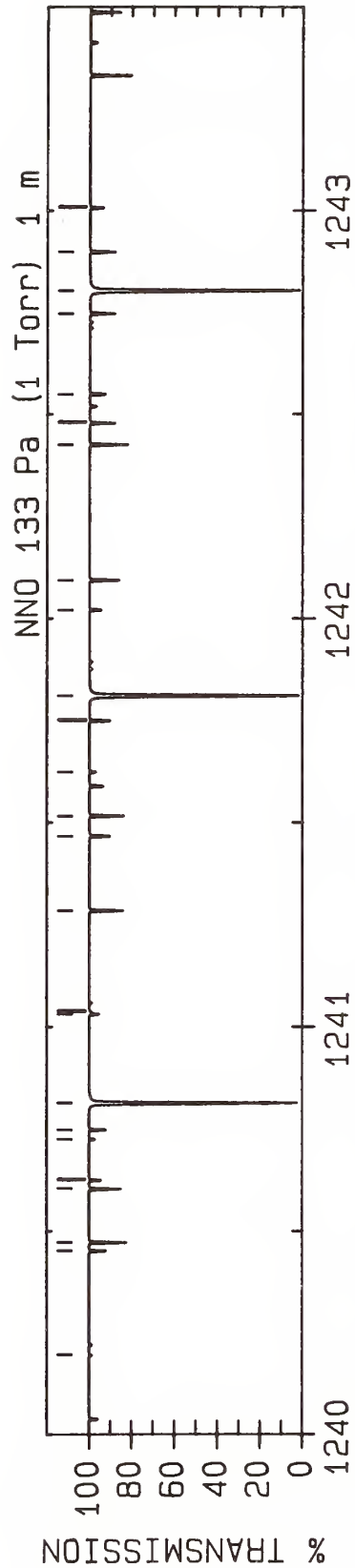

LINE #	WAVENUMBER(unc) (cm ⁻¹)	LOWER STATE (cm ⁻¹)	INTENSITY (cm/molecule)	ASSIGNMENT ROTATION BAND	LINE #	WAVENUMBER(unc) (cm ⁻¹)	LOWER STATE (cm ⁻¹)	INTENSITY (cm/molecule)	ASSIGNMENT ROTATION BAND
1	1240.195 7	734.59	0.166E-22	P(19) Y	36	1244.492 31(6)*	1699.17	0.212E-21	P(51) B
2	1240.452 63(6)*	1878.14	0.950E-22	P(55) B	37	1244.502 31(4)	4.75	0.914E-22	P(3) T
3	1240.473 54(3)	28.48	0.217E-21	P(8) T	38	1244.735 88(6)*	1701.27	0.212E-21	P(51) C
4	1240.604 49(6)	481.55	0.183E-21	P(34) R	39	1244.781 65(5)*	828.95	0.128E-19	P(44) A
5	1240.625 58(7)*	2037.90	0.673E-22	P(42) D	40	1244.969 08(6)	653.18	0.104E-21	P(39) P
6	1240.725 14(4)	330.11	0.341E-22	P(28) V	41	1245.134 70(6)	352.10	0.292E-21	P(29) R
7	1240.748 94(6)*	1880.57	0.949E-22	P(55) C	42	1245.299 32(4)	2.37	0.617E-22	P(2) T
8	1240.814 29(5)*	984.54	0.652E-20	P(48) A	43	1245.413 56(6)*	1871.22	0.133E-21	P(37) D
9	1241.031 63(6)	792.08	0.578E-22	P(43) P	44	1245.494 56(6)*	1656.51	0.256E-21	P(50) B
10	1241.037 2	719.56	0.169E-22	P(18) Y	45	1245.725 90(6)*	1658.53	0.256E-21	P(50) C
11	1241.285 11(3)	22.15	0.196E-21	P(7) T	46	1245.765 43(5)*	792.14	0.149E-19	P(43) A
12	1241.467 13(6)*	1832.15	0.117E-21	P(54) B	47	1245.944 64(6)	620.54	0.118E-21	P(38) P
13	1241.516 54(6)	454.04	0.203E-21	P(33) R	48	1246.071 37(4)	205.73	0.492E-22	P(22) V
14	1241.623 90(4)	307.35	0.367E-22	P(27) V	49	1246.093 40(4)	0.79	0.311E-22	P(1) T
15	1241.749 67(6)*	1834.50	0.117E-21	P(54) C	50	1246.362 28(6)*	1840.38	0.151E-21	P(36) D
16	1241.810 94(5)*	944.39	0.776E-20	P(47) A	51	1246.493 72(6)*	1614.68	0.308E-21	P(49) B
17	1242.021 26(6)	756.11	0.673E-22	P(42) P	52	1246.713 20(6)*	1616.62	0.307E-21	P(49) C
18	1242.093 78(4)	16.61	0.172E-21	P(6) T	53	1246.745 98(5)*	756.16	0.174E-19	P(42) A
19	1242.425 59(6)	427.35	0.224E-21	P(32) R	54	1246.916 67(6)	588.74	0.135E-21	P(37) P
20	1242.478 58(6)*	1786.99	0.143E-21	P(53) B	55	1246.925 64(6)	305.98	0.339E-21	P(27) R
21	1242.549 59(7)*	1968.74	0.897E-22	P(40) D	56	1246.951 55(4)	187.85	0.513E-22	P(21) V
22	1242.747 75(6)*	1789.25	0.143E-21	P(53) C	57	1247.308 00(6)*	1810.37	0.170E-21	P(35) D
23	1242.804 39(5)*	905.08	0.920E-20	P(46) A	58	1247.489 79(6)*	1573.69	0.369E-21	P(48) B
24	1242.899 53(4)	11.87	0.147E-21	P(5) T	59	1247.697 76(6)*	1575.55	0.368E-21	P(48) C
25	1243.007 39(6)	720.96	0.781E-22	P(41) P	60	1247.723 28(5)*	721.01	0.202E-19	P(41) A
26	1243.331 64(6)	401.46	0.246E-21	P(31) R	61	1247.816 55(6)	284.13	0.363E-21	P(26) R
27	1243.486 98(6)*	1742.67	0.174E-21	P(52) B	62	1247.828 60(3)	170.77	0.531E-22	P(20) V
28	1243.507 20(7)*	1935.40	0.103E-21	P(39) D	63	1247.885 17(5)	557.77	0.152E-21	P(36) P
29	1243.702 38(4)	7.91	0.120E-21	P(4) T	64	1248.250 71(6)*	1781.19	0.190E-21	P(34) D
30	1243.743 16(6)*	1744.84	0.174E-21	P(52) C	65	1248.458 06(4)	0.79	0.623E-22	R(1) T
31	1243.794 63(5)*	866.60	0.109E-19	P(45) A	66	1248.482 74(6)*	1533.53	0.439E-21	P(47) B
32	1243.989 99(6)	686.65	0.901E-22	P(40) P	67	1248.679 57(6)*	1535.31	0.439E-21	P(47) C
33	1244.234 68(6)	376.38	0.269E-21	P(30) R	68	1248.682 81(7)	2195.49	0.183E-22	P(49) G
34	1244.301 68(4)	243.94	0.445E-22	P(24) V	69	1248.697 32(5)*	686.70	0.233E-19	P(40) A
35	1244.461 87(6)*	1902.90	0.117E-21	P(38) D	70	1248.850 12(5)	527.64	0.172E-21	P(35) P

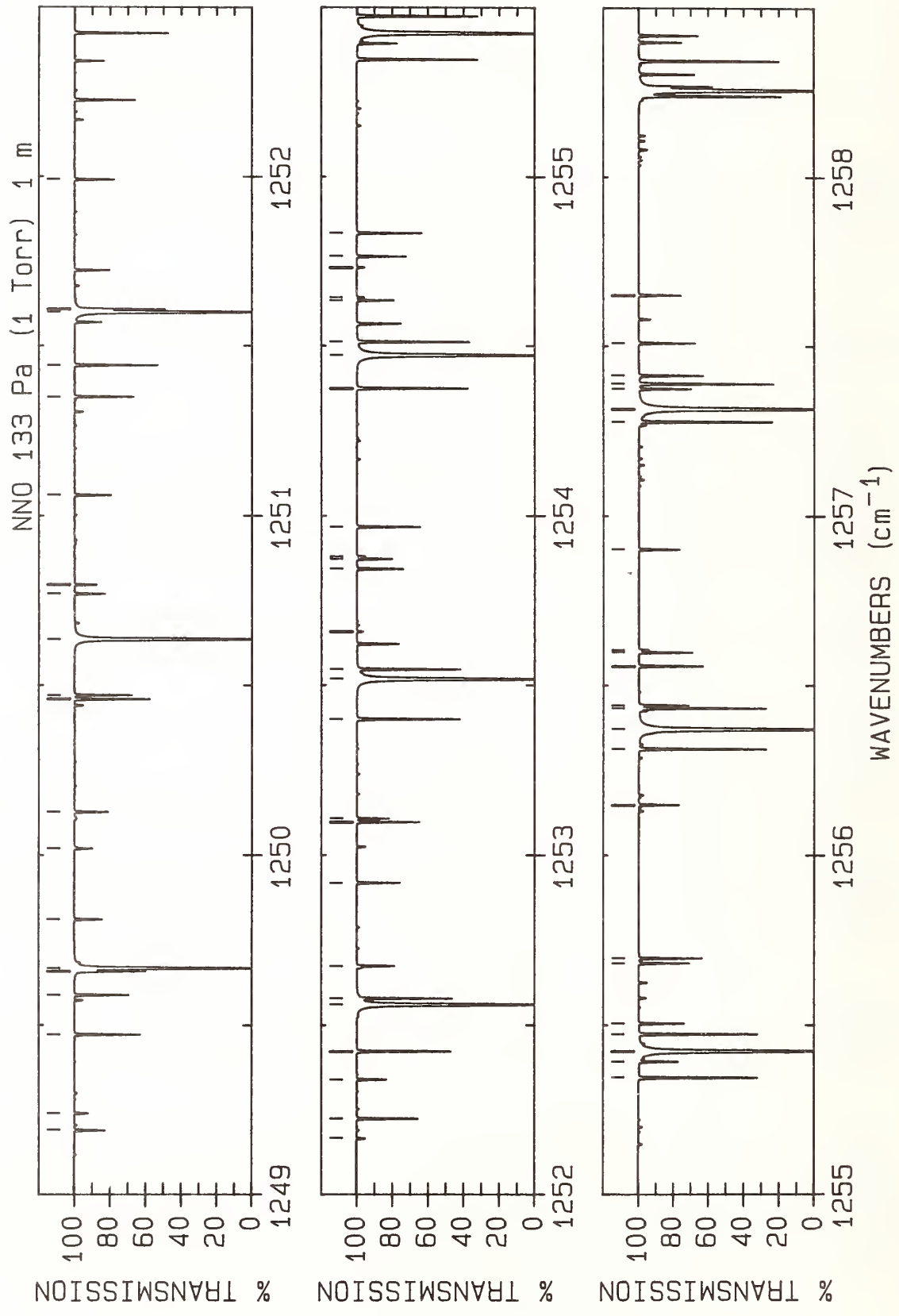

LINE #	WAVENUMBER(unc) (cm ⁻¹)	LOWER STATE (cm ⁻¹)	INTENSITY (cm/molecule)	ASSIGNMENT ROTATION BAND	LINE #	WAVENUMBER(unc) (cm ⁻¹)	LOWER STATE (cm ⁻¹)	INTENSITY (cm/molecule)	ASSIGNMENT ROTATION BAND
1	1249.190 40(6)*	1752.85	0.211E-21	P(33) D	36	1253.843 07(6)*	1623.60	0.336E-21	P(28) D
2	1249.240 41(4)	2.37	0.929E-22	R(2) T	37	1253.872 57(3)	28.48	0.246E-21	R(8) T
3	1249.472 58(6)*	1494.20	0.522E-21	P(46) B	38	1253.879 95(4)	74.01	0.554E-22	P(13) V
4	1249.589 22(5)	242.85	0.409E-21	P(24) R	39	1253.967 18(5)	153.82	0.497E-21	P(19) R
5	1249.658 61(6)*	1495.90	0.521E-21	P(46) C	40	1254.374 68(6)*	1310.06	0.115E-20	P(41) B
6	1249.668 10(5)*	653.23	0.267E-19	P(39) A	41	1254.472 69(5)*	498.37	0.496E-19	P(34) A
7	1249.811 53(5)	498.34	0.193E-21	P(34) P	42	1254.511 79(6)*	1311.42	0.115E-20	P(41) C
8	1250.019 81(4)	4.75	0.122E-21	R(3) T	43	1254.634 26(3)	35.60	0.265E-21	R(9) T
9	1250.127 06(6)*	1725.33	0.234E-21	P(32) D	44	1254.643 26(7)	1961.75	0.505E-22	P(43) G
10	1250.459 29(6)*	1455.70	0.616E-21	P(45) B	45	1254.731 78(4)	63.44	0.539E-22	P(12) V
11	1250.470 97(5)	223.43	0.430E-21	P(23) R	46	1254.764 36(5)*	1600.25	0.363E-21	P(27) D
12	1250.634 87(6)*	1457.34	0.616E-21	P(45) C	47	1254.833 51(5)	138.44	0.507E-21	P(18) R
13	1250.635 60(5)*	620.59	0.305E-19	P(38) A	48	1255.345 61(5)*	1275.74	0.132E-20	P(40) B
14	1250.769 38(5)	469.88	0.215E-21	P(33) P	49	1255.392 99(3)	43.51	0.280E-21	R(10) T
15	1250.796 26(4)	7.91	0.151E-21	R(4) T	50	1255.423 69(5)*	469.91	0.554E-19	P(33) A
16	1251.060 66(6)*	1698.65	0.258E-21	P(31) D	51	1255.473 92(6)*	1277.04	0.132E-20	P(40) C
17	1251.349 64(5)	204.82	0.450E-21	P(22) R	52	1255.505 19(5)	340.10	0.344E-21	P(28) P
18	1251.442 86(6)*	1418.04	0.725E-21	P(44) B	53	1255.682 54(5)*	1577.73	0.390E-21	P(26) D
19	1251.599 82(5)*	588.78	0.347E-19	P(37) A	54	1255.696 74(5)	123.87	0.514E-21	P(17) R
20	1251.608 33(6)*	1419.61	0.724E-21	P(44) C	55	1256.148 75(3)	52.21	0.293E-21	R(11) T
21	1251.991 21(6)*	1672.80	0.284E-21	P(30) D	56	1256.313 37(5)*	1242.25	0.152E-20	P(39) B
22	1252.166 77(4)	97.59	0.570E-22	P(15) V	57	1256.371 37(5)*	442.28	0.615E-19	P(32) A
23	1252.225 24(5)	187.01	0.468E-21	P(21) R	58	1256.433 18(6)*	1243.48	0.152E-20	P(39) C
24	1252.340 32(3)	16.61	0.203E-21	R(6) T	59	1256.441 62(5)	316.65	0.373E-21	P(27) P
25	1252.423 29(6)*	1381.21	0.848E-21	P(43) B	60	1256.556 86(5)	110.11	0.517E-21	P(16) R
26	1252.560 74(5)*	557.81	0.393E-19	P(36) A	61	1256.597 61(5)*	1556.05	0.417E-21	P(25) D
27	1252.578 98(6)*	1382.71	0.847E-21	P(43) C	62	1256.604 33(7)	1890.51	0.683E-22	P(41) G
28	1252.674 41(5)	415.46	0.264E-21	P(31) P	63	1256.901 56(3)	61.71	0.304E-21	R(12) T
29	1252.918 68(6)*	1647.79	0.310E-21	P(29) D	64	1257.277 93(5)*	1209.60	0.174E-20	P(38) B
30	1253.097 75(5)	170.01	0.484E-21	P(20) R	65	1257.315 72(5)*	415.49	0.679E-19	P(31) A
31	1253.107 93(3)	22.15	0.226E-21	R(7) T	66	1257.374 47(5)	294.04	0.401E-21	P(26) P
32	1253.400 57(6)*	1345.22	0.988E-21	P(42) B	67	1257.389 57(5)*	1210.77	0.174E-20	P(38) C
33	1253.518 37(5)*	527.67	0.443E-19	P(35) A	68	1257.413 87(5)	97.16	0.516E-21	P(15) R
34	1253.546 81(6)*	1346.65	0.987E-21	P(42) C	69	1257.509 55(5)*	1535.19	0.443E-21	P(24) D
35	1253.657 88(7)	1998.62	0.432E-22	P(44) G	70	1257.651 40(3)	71.99	0.311E-21	R(13) T

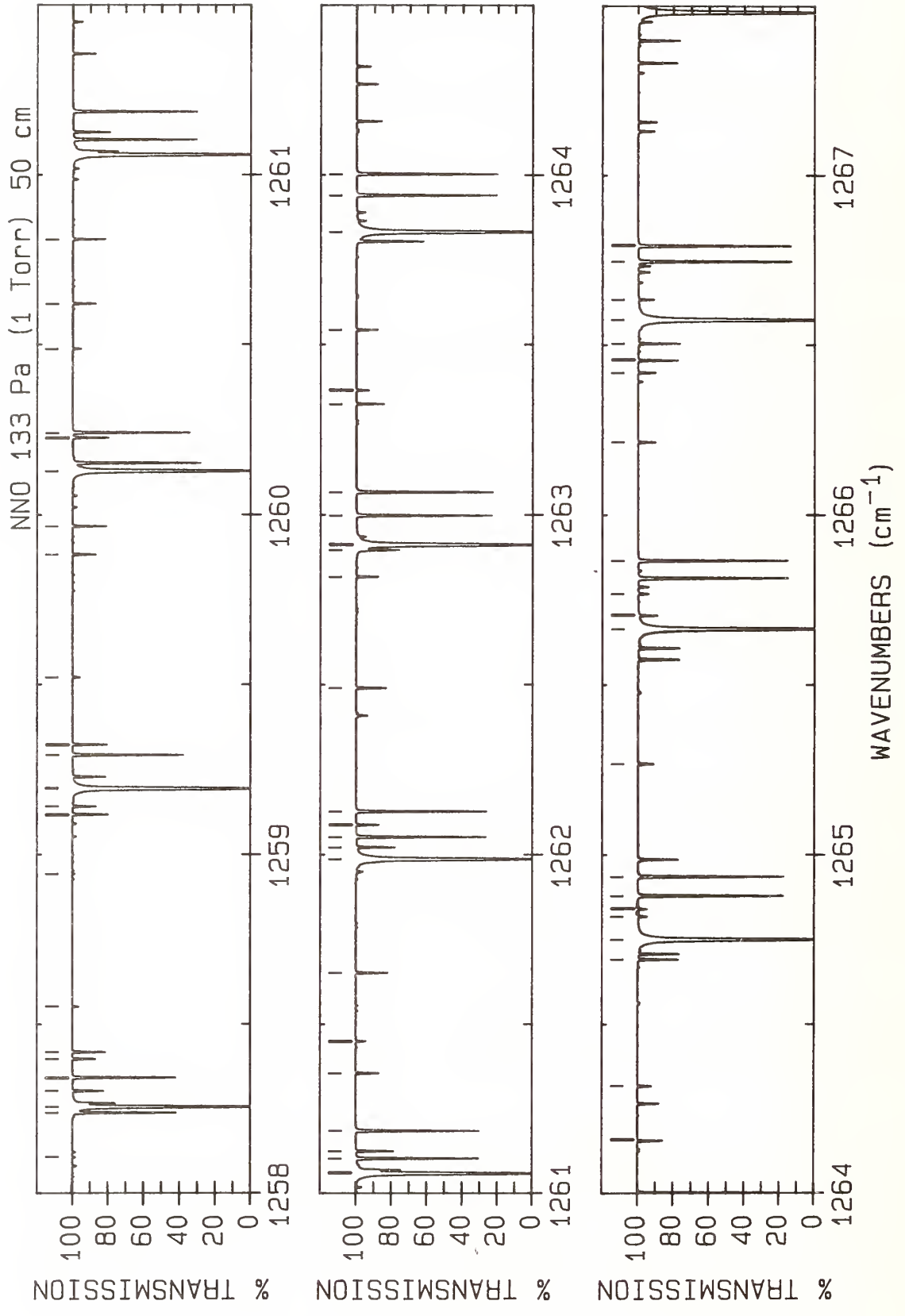

LINE #	WAVENUMBER(unc) (cm ⁻¹)	LOWER STATE (cm ⁻¹)	INTENSITY (cm/molecule)	ASSIGNMENT ROTATION BAND	LINE #	WAVENUMBER(unc) (cm ⁻¹)	LOWER STATE (cm ⁻¹)	INTENSITY (cm/molecule)	ASSIGNMENT ROTATION BAND
1	1258.107 25(5)	29.28	0.425E-22	P(8)	36	1262.127 86(5)*	1059.75	0.316E-20	P(33)
2	1258.239 30(5)*	1177.78	0.198E-20	P(37)	37	1262.490 27(5)	36.44	0.415E-21	P(9)
3	1258.256 73(5)*	389.53	0.746E-19	P(30)	38	1262.817 32(3)	166.12	0.297E-21	R(20)
4	1258.303 72(5)	272.26	0.429E-21	P(25)	39	1262.895 95(5)	175.94	0.550E-21	P(20)
5	1258.343 06(5)*	1178.89	0.198E-20	P(37)	40	1262.911 47(5)*	272.28	0.110E-18	P(25)
6	1258.398 28(3)	83.06	0.316E-21	R(14)	41	1262.914 97(4)*	1427.58	0.561E-21	P(18)
7	1258.418 35(5)*	1515.18	0.468E-21	P(23)	42	1262.997 90(5)*	1031.22	0.351E-20	P(32)
8	1258.552 45(6)	1822.61	0.906E-22	P(39)	43	1263.066 72(5)*	1032.06	0.351E-20	P(32)
9	1258.943 13(5)	22.77	0.384E-22	P(7)	44	1263.325 34(5)	29.15	0.382E-21	P(8)
10	1259.118 54(5)	73.68	0.501E-21	P(13)	45	1263.365 74(6)	1667.49	0.169E-21	P(34)
11	1259.142 20(3)	94.93	0.319E-21	R(15)	46	1263.543 45(3)	182.72	0.287E-21	R(21)
12	1259.194 40(5)*	364.41	0.815E-19	P(29)	47	1263.832 31(5)*	251.34	0.117E-18	P(24)
13	1259.197 46(5)*	1146.80	0.224E-20	P(36)	48	1263.939 92(5)*	1004.42	0.388E-20	P(31)
14	1259.293 64(5)*	1147.85	0.224E-20	P(36)	49	1264.002 61(5)*	1005.20	0.387E-20	P(31)
15	1259.324 01(5)*	1495.99	0.492E-21	P(22)	50	1264.157 26(5)	22.67	0.345E-21	P(7)
16	1259.521 64(6)	1789.92	0.104E-21	P(38)	51	1264.318 57(6)	1638.97	0.189E-21	P(33)
17	1259.883 15(3)	107.58	0.319E-21	R(16)	52	1264.691 34(4)*	1398.38	0.575E-21	P(16)
18	1259.966 18(5)	63.15	0.486E-21	P(12)	53	1264.749 76(5)*	231.24	0.124E-18	P(23)
19	1260.128 71(5)*	340.12	0.887E-19	P(28)	54	1264.817 75(13)	1737.13	0.123E-21	P(36)
20	1260.226 51(5)*	1477.64	0.513E-21	P(21)	55	1264.839 99(12)	1737.03	0.123E-21	P(36)
21	1260.241 31(5)*	1117.64	0.252E-20	P(35)	56	1264.878 68(5)*	978.45	0.426E-20	P(30)
22	1260.487 57(6)	1758.06	0.118E-21	P(37)	57	1264.935 53(5)*	979.18	0.426E-20	P(30)
23	1260.621 14(3)	121.03	0.316E-21	R(17)	58	1265.268 10(6)	1611.29	0.209E-21	P(32)
24	1260.810 68(5)	53.44	0.467E-21	P(11)	59	1265.663 82(5)*	211.97	0.130E-18	P(22)
25	1261.059 67(5)*	316.67	0.959E-19	P(27)	60	1265.704 10(3)	237.29	0.251E-21	R(24)
26	1261.104 14(5)*	1087.34	0.283E-20	P(34)	61	1265.767 79(12)	1706.91	0.139E-21	P(35)
27	1261.125 84(5)*	1460.12	0.532E-21	P(20)	62	1265.865 47(5)*	954.01	0.466E-20	P(29)
28	1261.186 06(5)*	1088.28	0.283E-20	P(34)	63	1266.214 32(6)	1584.45	0.231E-21	P(31)
29	1261.356 16(2)	135.27	0.312E-21	R(18)	64	1266.418 41(3)	257.06	0.237E-21	R(25)
30	1261.450 24(6)	1727.03	0.134E-21	P(36)	65	1266.454 88(4)*	1372.52	0.571E-21	P(14)
31	1261.652 05(5)	44.53	0.443E-21	P(10)	66	1266.504 60(5)	113.95	0.597E-21	P(16)
32	1261.987 26(5)*	294.06	0.103E-18	P(26)	67	1266.574 48(5)*	193.54	0.136E-18	P(21)
33	1262.022 00(5)*	1443.43	0.548E-21	P(19)	68	1266.634 05(5)	8.10	0.212E-21	P(4)
34	1262.052 64(5)*	1058.86	0.316E-20	P(33)	69	1266.746 43(5)*	929.02	0.507E-20	P(28)
35	1262.088 22(2)	150.30	0.305E-21	R(19)	70	1266.792 41(5)*	929.66	0.506E-20	P(28)

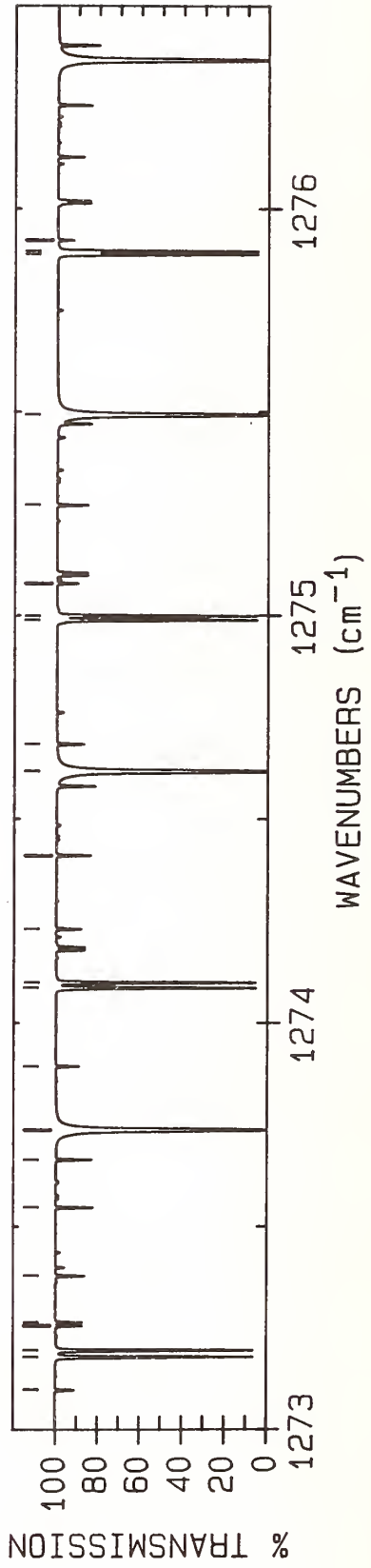
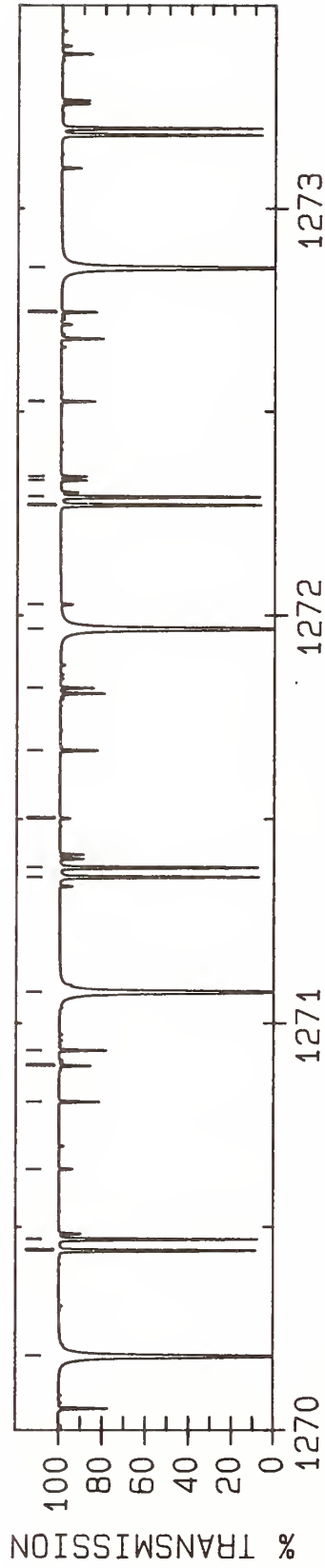
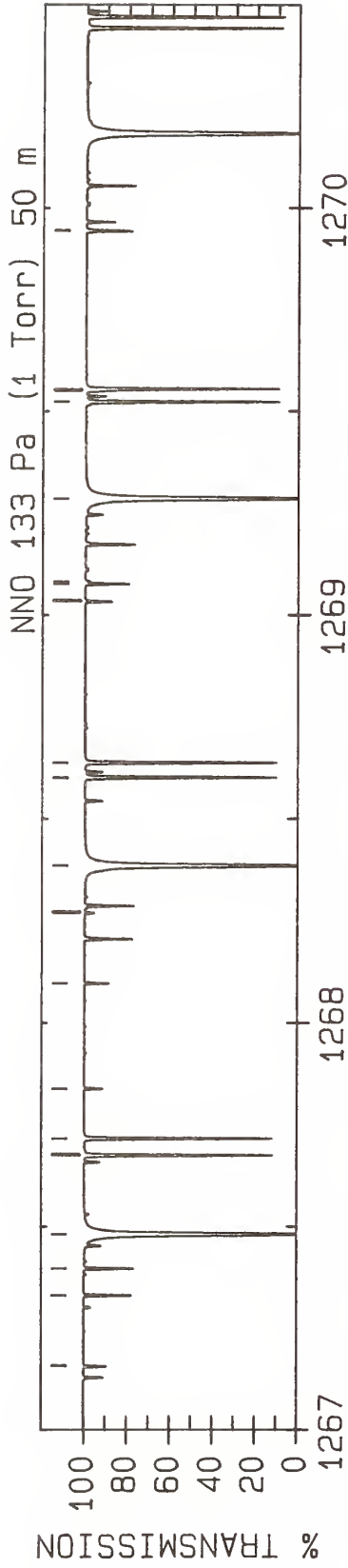

LINE #	WAVENUMBER(unc) (cm ⁻¹)	LOWER STATE (cm ⁻¹)	INTENSITY (cm/molecule)	ASSIGNMENT ROTATION BAND	LINE #	WAVENUMBER(unc) (cm ⁻¹)	LOWER STATE (cm ⁻¹)	INTENSITY (cm/molecule)	ASSIGNMENT ROTATION BAND
1	1267.157 23(6)	1558.45	0.254E-21	P(30)	36	1271.667 97(5)*	1314.94	0.432E-21	P(8)
2	1267.331 82(4)*	1360.84	0.561E-21	P(13)	37	1271.821 82(6)	1440.98	0.377E-21	P(25)
3	1267.397 67(5)	100.55	0.598E-21	P(15)	38	1271.966 74(5)*	100.55	0.153E-18	P(15)
4	1267.481 74(5)*	175.95	0.141E-18	P(20)	39	1272.026 84(3)	443.64	0.126E-21	R(33)
5	1267.675 14(11)	1648.90	0.175E-21	P(33)	40	1272.270 91(5)*	800.83	0.747E-20	P(22)
6	1267.675 40(5)*	905.56	0.549E-20	P(27)	41	1272.290 71(5)*	801.23	0.746E-20	P(22)
7	1267.716 36(5)*	906.16	0.548E-20	P(27)	42	1272.331 62(9)	1518.81	0.285E-21	P(28)
8	1267.838 16(3)	298.97	0.209E-21	R(27)	43	1272.341 02(9)	1518.77	0.285E-21	P(28)
9	1268.096 83(6)	1533.28	0.278E-21	P(29)	44	1272.525 45(5)*	1308.27	0.390E-21	P(7)
10	1268.269 38(5)	2.43	0.109E-21	P(2)	45	1272.744 68(6)	1420.00	0.401E-21	P(24)
11	1268.385 58(5)*	159.20	0.146E-18	P(19)	46	1272.853 44(5)*	87.98	0.152E-18	P(14)
12	1268.599 42(11)	1621.26	0.195E-21	P(32)	47	1273.098 93(5)	4.86	0.216E-21	R(3)
13	1268.601 09(5)*	882.94	0.590E-20	P(26)	48	1273.180 10(5)*	782.39	0.780E-20	P(21)
14	1268.637 29(5)*	883.50	0.589E-20	P(26)	49	1273.196 45(5)*	782.76	0.779E-20	P(21)
15	1269.033 09(6)	1508.94	0.303E-21	P(28)	50	1273.256 91(9)	1495.29	0.309E-21	P(27)
16	1269.076 02(5)*	1339.98	0.525E-21	P(11)	51	1273.265 21(8)	1495.26	0.309E-21	P(27)
17	1269.082 28(5)	0.81	0.549E-22	P(1)	52	1273.379 66(5)*	1302.43	0.344E-21	P(6)
18	1269.286 01(5)*	143.28	0.149E-18	P(18)	53	1273.546 94(6)	30.17	0.451E-21	P(8)
19	1269.523 49(5)*	861.16	0.631E-20	P(25)	54	1273.664 17(5)	1399.85	0.424E-21	P(23)
20	1269.550 44(10)	1594.33	0.216E-21	P(31)	55	1273.736 71(5)*	76.25	0.150E-18	P(13)
21	1269.555 20(5)*	861.67	0.631E-20	P(25)	56	1273.892 66(5)	8.10	0.266E-21	R(4)
22	1269.943 25(5)*	1330.80	0.500E-21	P(10)	57	1274.085 98(5)*	764.79	0.810E-20	P(20)
23	1269.945 71(3)	367.75	0.166E-21	R(30)	58	1274.099 12(5)*	765.12	0.809E-20	P(20)
24	1270.183 02(5)*	128.20	0.152E-18	P(17)	59	1274.230 59(5)*	1297.42	0.294E-21	P(5)
25	1270.442 60(5)*	840.21	0.672E-20	P(24)	60	1274.410 74(6)	23.46	0.408E-21	P(7)
26	1270.470 08(5)*	840.68	0.671E-20	P(24)	61	1274.616 51(5)*	65.36	0.146E-18	P(12)
27	1270.471 72(10)	1568.36	0.238E-21	P(30)	62	1274.683 19(5)	12.15	0.312E-21	R(5)
28	1270.642 35(3)	392.26	0.152E-21	R(31)	63	1274.988 53(5)*	748.03	0.835E-20	P(19)
29	1270.807 24(5)*	1322.45	0.468E-21	P(9)	64	1274.998 72(5)*	748.33	0.834E-20	P(19)
30	1270.895 59(6)	1462.80	0.352E-21	P(26)	65	1275.078 26(5)*	1293.25	0.240E-21	P(4)
31	1270.933 50(5)	55.30	0.548E-21	P(11)	66	1275.270 87(6)	17.60	0.360E-21	P(6)
32	1271.076 60(5)*	113.96	0.153E-18	P(16)	67	1275.492 87(5)*	55.31	0.140E-18	P(11)
33	1271.358 41(5)*	820.10	0.710E-20	P(23)	68	1275.887 75(5)*	732.11	0.856E-20	P(18)
34	1271.381 92(5)*	820.54	0.709E-20	P(23)	69	1275.895 24(5)*	732.38	0.854E-20	P(18)
35	1271.501 85(5)	0.81	0.110E-21	R(1)	70	1275.922 64(5)*	1289.91	0.183E-21	P(3)

NNO 133 Pa (1 Torr) 50 cm

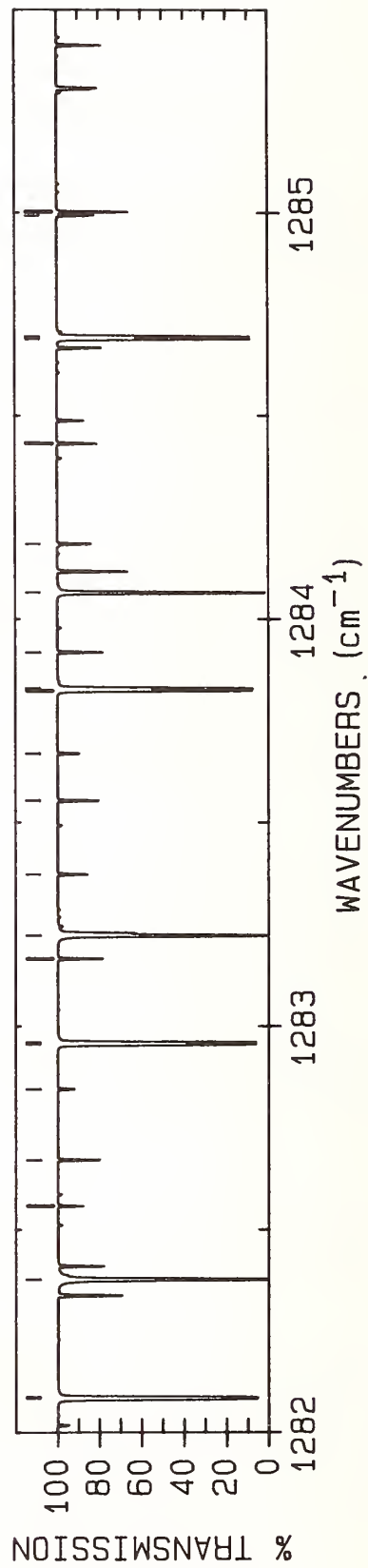
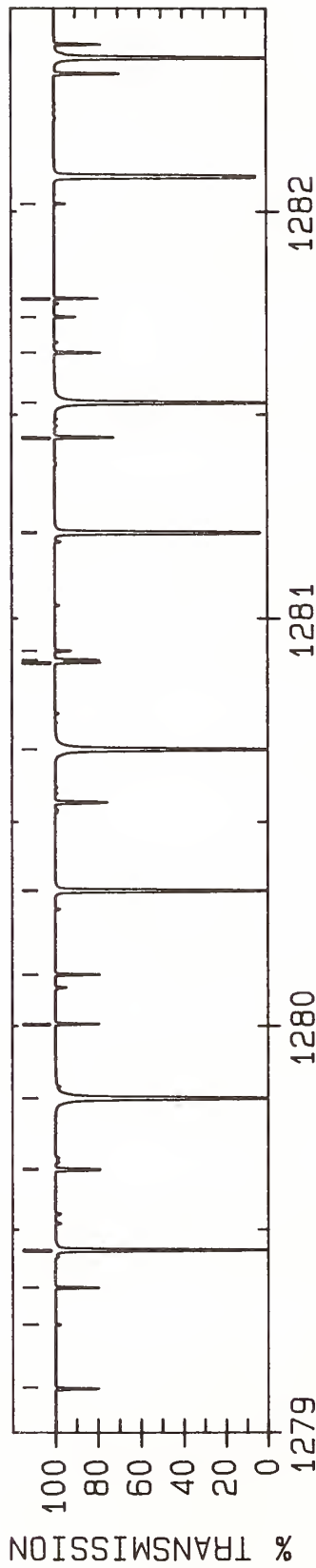
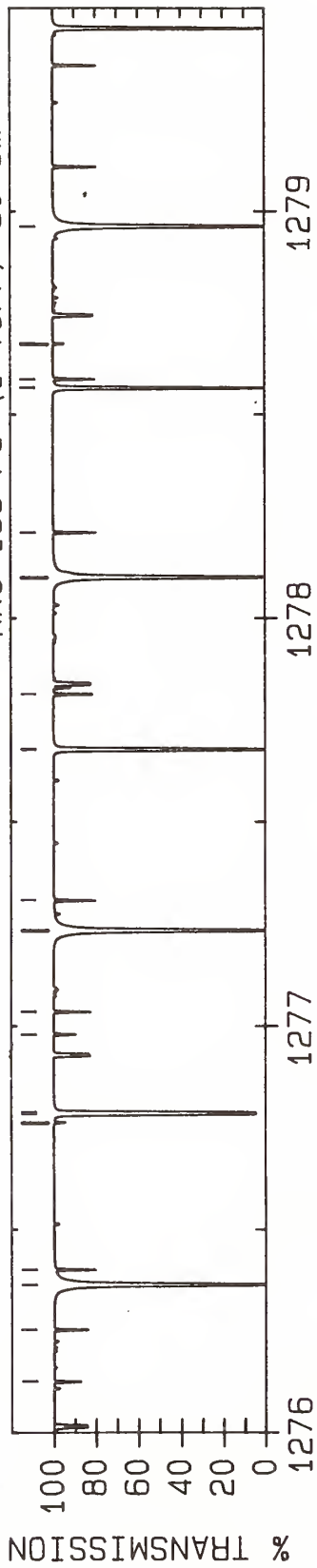

LINE #	WAVENUMBER(unc) (cm ⁻¹)	LOWER STATE (cm ⁻¹)	INTENSITY (cm/molecule)	ASSIGNMENT ROTATION BAND	LINE #	WAVENUMBER(unc) (cm ⁻¹)	LOWER STATE (cm ⁻¹)	INTENSITY (cm/molecule)	ASSIGNMENT ROTATION BAND
1	1276.127 31(6)	12.57	0.307E-21	P(5)	36	1280.897 78(5)	1268.90	0.525E-21	P(15)
2	1276.254 61(5)	22.67	0.396E-21	R(7)	37	1280.919 77(5)*	1287.41	0.186E-21	R(2)
3	1276.365 76(5)*	46.09	0.134E-18	P(10)	38	1281.209 23(5)*	654.28	0.832E-20	P(12)
4	1276.402 34(5)	1344.45	0.484E-21	P(20)	39	1281.212 80(5)*	654.15	0.834E-20	P(12)
5	1276.763 73(5)*	1287.41	0.124E-21	P(2)	40	1281.444 14(8)	1321.41	0.487E-21	P(18)
6	1276.783 63(5)*	717.02	0.870E-20	P(17)	41	1281.446 24(8)	1321.41	0.487E-21	P(18)
7	1276.788 67(5)*	717.26	0.869E-20	P(17)	42	1281.530 17(5)*	8.38	0.644E-19	P(4)
8	1276.980 06(6)	8.38	0.251E-21	P(4)	43	1281.653 13(5)	85.01	0.552E-21	R(14)
9	1277.035 50(5)	29.15	0.433E-21	R(8)	44	1281.741 06(5)*	1289.91	0.244E-21	R(3)
10	1277.235 19(5)*	37.71	0.125E-18	P(9)	45	1281.786 57(5)	1256.31	0.521E-21	P(14)
11	1277.308 27(5)	1327.67	0.499E-21	P(19)	46	1282.018 91(6)	0.84	0.131E-21	R(1)
12	1277.676 17(5)*	702.77	0.878E-20	P(16)	47	1282.083 98(5)*	644.20	0.801E-20	P(11)
13	1277.679 00(5)*	702.99	0.877E-20	P(16)	48	1282.088 55(5)*	644.10	0.802E-20	P(11)
14	1277.813 16(5)	36.44	0.464E-21	R(9)	49	1282.378 70(5)*	5.03	0.491E-19	P(3)
15	1278.101 15(5)*	30.17	0.116E-18	P(8)	50	1282.559 03(5)*	1293.25	0.301E-21	R(4)
16	1278.210 78(5)	1311.72	0.511E-21	P(18)	51	1282.671 90(5)	1244.55	0.513E-21	P(13)
17	1278.565 36(5)*	689.36	0.878E-20	P(15)	52	1282.845 73(6)	2.51	0.194E-21	R(2)
18	1278.566 23(5)*	689.55	0.877E-20	P(15)	53	1282.955 59(5)*	634.96	0.760E-20	P(10)
19	1278.587 61(5)	44.53	0.491E-21	R(10)	54	1282.960 92(5)*	634.88	0.761E-20	P(10)
20	1278.674 49(6)	2.51	0.129E-21	P(2)	55	1283.166 49(5)	1110.11	0.555E-21	R(16)
21	1278.963 63(5)*	23.46	0.105E-18	P(7)	56	1283.223 73(5)*	2.51	0.331E-19	P(2)
22	1279.109 88(5)	1296.61	0.520E-21	P(17)	57	1283.373 69(5)*	1297.42	0.354E-21	R(5)
23	1279.267 26(5)*	1284.90	0.626E-22	R(0)	58	1283.553 78(5)	1233.63	0.499E-21	P(12)
24	1279.358 83(5)	53.44	0.514E-21	R(11)	59	1283.668 83(6)	5.03	0.256E-21	R(3)
25	1279.450 35(5)*	676.95	0.870E-20	P(14)	60	1283.824 06(5)*	626.56	0.712E-20	P(9)
26	1279.451 21(5)*	676.79	0.872E-20	P(14)	61	1283.829 91(5)*	626.49	0.713E-20	P(9)
27	1279.646 66(8)	1354.18	0.461E-21	P(20)	62	1283.918 31(5)	123.87	0.551E-21	R(17)
28	1279.649 64(8)	1354.16	0.461E-21	P(20)	63	1284.065 26(5)*	0.84	0.167E-19	P(1)
29	1279.822 63(5)*	17.60	0.922E-19	P(6)	64	1284.185 04(5)*	1302.43	0.403E-21	R(6)
30	1280.005 54(5)	1282.33	0.524E-21	P(16)	65	1284.432 20(5)	1223.56	0.481E-21	P(11)
31	1280.126 83(5)	63.15	0.531E-21	R(12)	66	1284.689 38(5)*	619.00	0.654E-20	P(8)
32	1280.331 35(5)*	665.20	0.856E-20	P(13)	67	1284.695 52(5)*	618.95	0.655E-20	P(8)
33	1280.333 69(5)*	665.05	0.857E-20	P(13)	68	1284.993 06(5)*	1308.27	0.447E-21	R(7)
34	1280.678 14(5)*	12.57	0.788E-19	P(5)	69	1285.001 43(10)	1265.97	0.496E-21	P(14)
35	1280.891 59(5)	73.68	0.544E-21	R(13)	70	1285.002 33(10)	1265.96	0.496E-21	P(14)

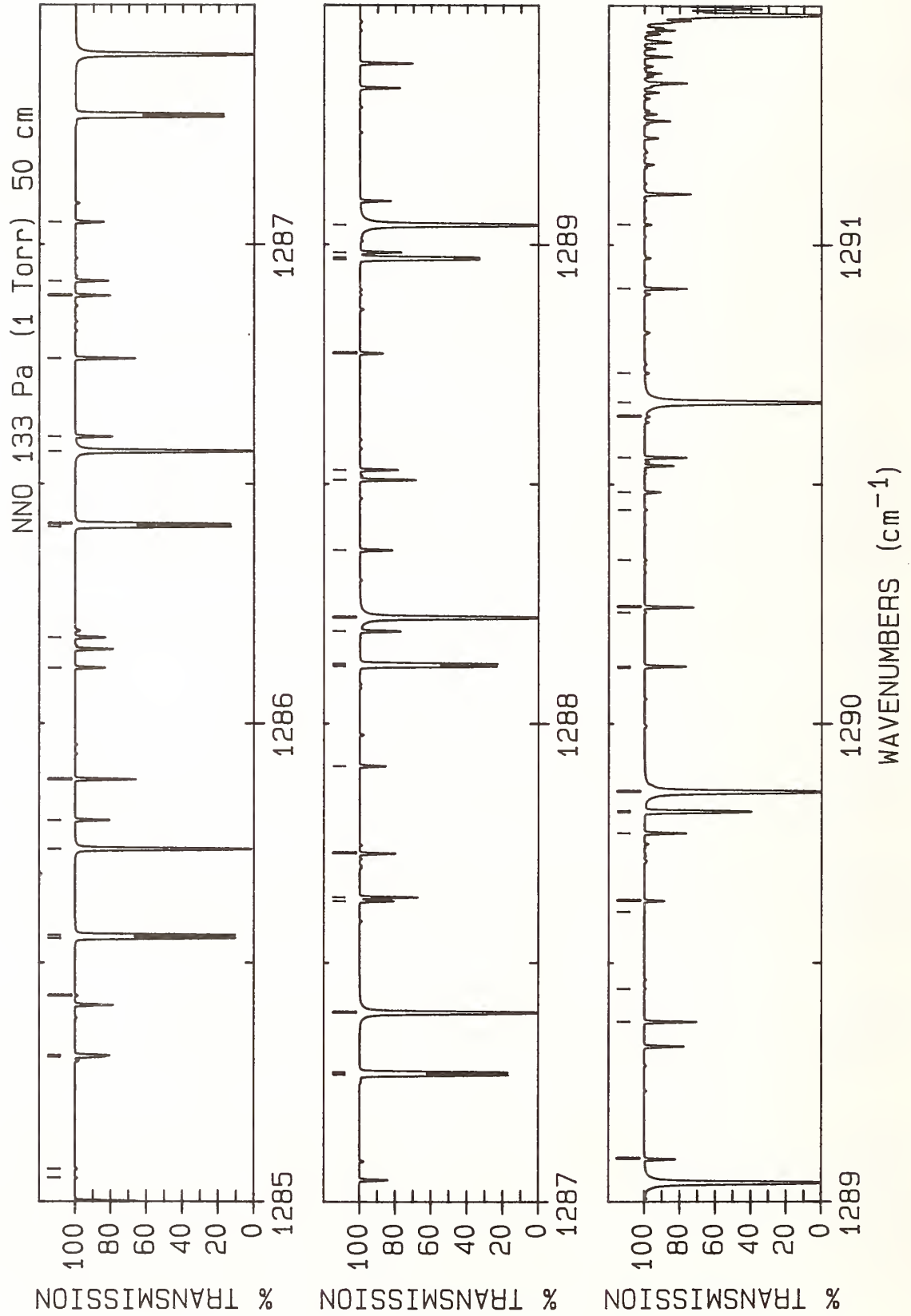

LINE #	WAVENUMBER(unc) (cm ⁻¹)	LOWER STATE (cm ⁻¹)	INTENSITY (cm/molecule)	ASSIGNMENT ROTATION BAND	LINE #	WAVENUMBER(unc) (cm ⁻¹)	LOWER STATE (cm ⁻¹)	INTENSITY (cm/molecule)	ASSIGNMENT ROTATION BAND
1	1285.050 03(32)	1837.48	0.311E-22	P(14) K	36	1288.361 16(6)	223.43	0.456E-21	R(23) R
2	1285.069 41(32)	1837.17	0.312E-22	P(14) J	37	1288.508 32(11)	1223.96	0.429E-21	P(10) E
3	1285.303 85(6)	12.57	0.370E-21	R(5) P	38	1288.508 62(11)	1223.96	0.429E-21	P(10) F
4	1285.307 14(6)	1214.32	0.457E-21	P(10) G	39	1288.529 06(5)	37.71	0.546E-21	R(9) P
5	1285.431 34(4)	285.40	0.415E-22	R(26) V	40	1288.772 03(6)	1185.77	0.316E-21	P(6) G
6	1285.551 55(5)*	612.29	0.589E-20	P(7) C	41	1288.968 56(5)*	593.81	0.251E-20	P(3) C
7	1285.557 74(5)*	612.24	0.590E-20	P(7) B	42	1288.972 61(5)*	593.80	0.251E-20	P(3) B
8	1285.737 79(5)*	0.00	0.168E-19	R(0) A	43	1288.983 24(4)*	1349.99	0.594E-21	R(12) D
9	1285.797 75(5)*	1314.94	0.487E-21	R(8) D	44	1289.040 63(5)*	8.38	0.807E-19	R(4) A
10	1285.882 88(10)	1254.20	0.487E-21	P(13) E	45	1289.090 27(6)	242.85	0.433E-21	R(24) R
11	1285.883 59(10)	1254.20	0.487E-21	P(13) F	46	1289.377 14(12)	1215.56	0.399E-21	P(9) E
12	1286.115 77(6)	17.60	0.421E-21	R(6) P	47	1289.377 36(12)	1215.55	0.399E-21	P(9) F
13	1286.178 60(6)	1205.92	0.429E-21	P(9) G	48	1289.446 24(36)	1786.96	0.255E-22	P(9) K
14	1286.410 55(5)*	606.41	0.516E-20	P(6) C	49	1289.606 55(5)*	906.16	0.149E-22	Q(27) C
15	1286.416 56(5)*	606.37	0.516E-20	P(6) B	50	1289.629 50(6)	1180.73	0.270E-21	P(5) G
16	1286.568 79(5)*	0.84	0.334E-19	R(1) A	51	1289.771 29(4)*	1360.84	0.607E-21	R(13) D
17	1286.599 12(5)*	1322.45	0.522E-21	R(9) D	52	1289.814 87(5)*	591.29	0.143E-20	P(2) C
18	1286.761 19(11)	1243.28	0.473E-21	P(12) E	53	1289.816 14(6)	263.09	0.409E-21	R(25) R
19	1286.761 73(11)	1243.28	0.473E-21	P(12) F	54	1289.817 81(5)*	591.28	0.143E-20	P(2) B
20	1286.893 19(5)	187.01	0.498E-21	R(21) R	55	1289.857 52(5)*	12.57	0.949E-19	R(5) A
21	1286.923 94(5)	23.46	0.468E-21	R(7) P	56	1290.116 40(5)*	820.54	0.265E-22	Q(23) C
22	1287.046 57(6)	1198.37	0.396E-21	P(8) G	57	1290.119 18(5)	55.30	0.602E-21	R(11) P
23	1287.266 39(5)*	601.37	0.435E-20	P(5) C	58	1290.231 41(5)*	801.23	0.304E-22	Q(22) C
24	1287.271 98(5)*	601.34	0.436E-20	P(5) B	59	1290.242 81(12)	1207.99	0.363E-21	P(8) E
25	1287.396 26(5)*	2.51	0.498E-19	R(2) A	60	1290.242 95(12)	1207.99	0.363E-21	P(8) F
26	1287.397 16(5)*	1330.80	0.552E-21	R(10) D	61	1290.341 45(5)*	782.76	0.348E-22	Q(21) C
27	1287.628 80(5)	204.82	0.478E-21	R(22) R	62	1290.446 51(5)*	765.12	0.398E-22	Q(20) C
28	1287.636 33(11)	1233.20	0.454E-21	P(11) E	63	1290.483 46(6)	1176.53	0.220E-21	P(4) G
29	1287.636 74(11)	1233.20	0.454E-21	P(11) F	64	1290.556 00(4)*	1372.52	0.615E-21	R(14) D
30	1287.728 37(5)	30.17	0.510E-21	R(8) P	65	1290.641 65(5)*	732.38	0.518E-22	Q(18) C
31	1287.911 05(6)	1191.65	0.358E-21	P(7) G	66	1290.670 88(5)*	17.60	0.108E-18	R(6) A
32	1288.119 06(5)*	597.17	0.347E-20	P(4) C	67	1290.731 73(5)*	717.26	0.590E-22	Q(17) C
33	1288.124 00(5)*	597.15	0.348E-20	P(4) B	68	1290.908 60(5)	65.36	0.621E-21	R(12) P
34	1288.191 87(4)*	1339.98	0.576E-21	R(11) D	69	1291.042 12(5)*	665.20	0.986E-22	Q(13) C
35	1288.220 21(5)*	5.03	0.656E-19	R(3) A					

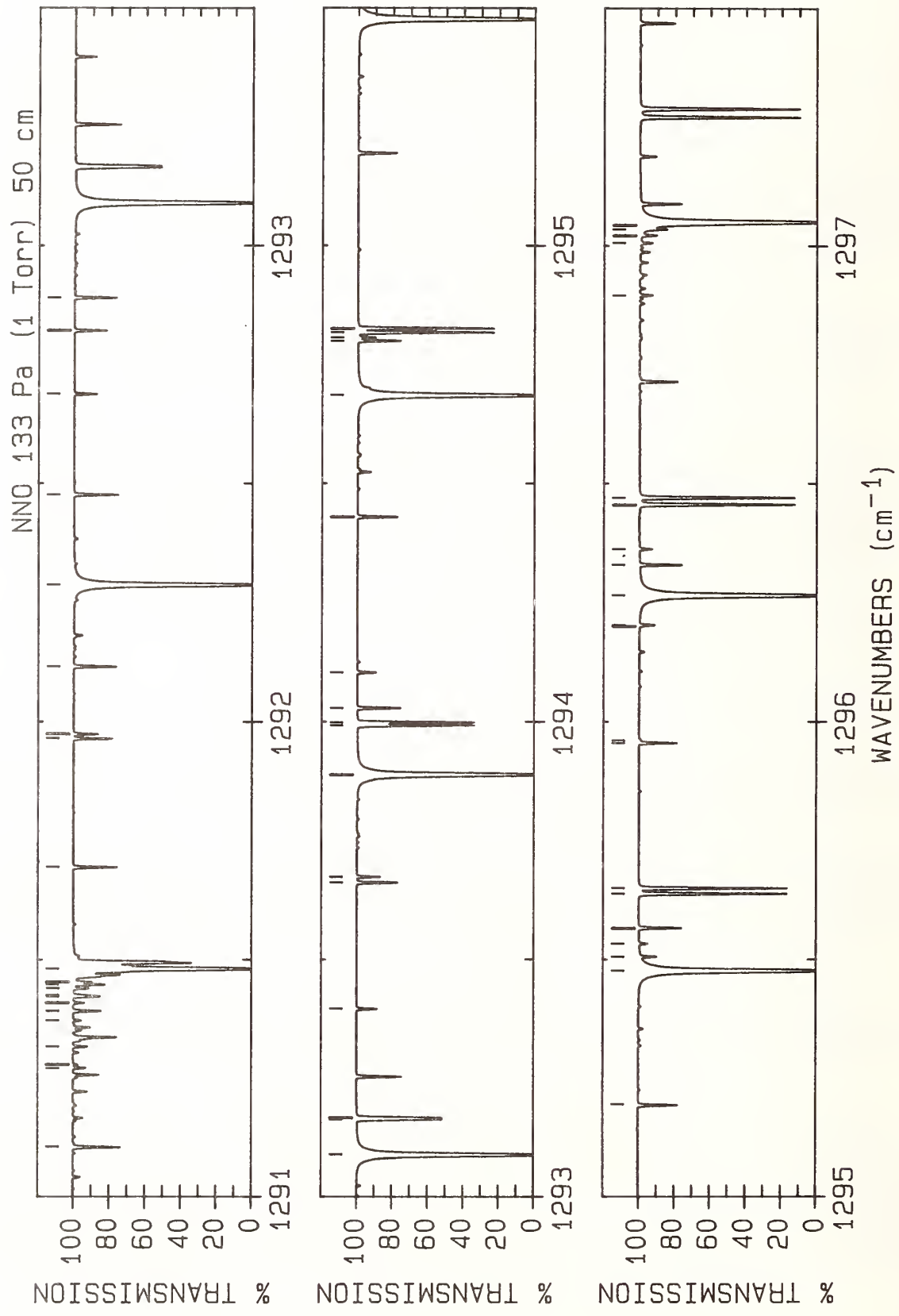

LINE #	WAVENUMBER(unc) (cm ⁻¹)	LOWER STATE (cm ⁻¹)	INTENSITY (cm/molecule)	ASSIGNMENT ROTATION BAND	LINE #	WAVENUMBER(unc) (cm ⁻¹)	LOWER STATE (cm ⁻¹)	INTENSITY (cm/molecule)	ASSIGNMENT ROTATION BAND
1	1291.105 30(12)	1201.27	0.322E-21	P(7) E	36	1293.992 43(5)*	591.28	0.255E-20	R(2) B
2	1291.105 40(12)	1201.27	0.322E-21	P(7) F	37	1293.998 58(5)*	591.29	0.255E-20	R(2) C
3	1291.107 22(5)*	654.28	0.112E-21	Q(12) C	38	1294.028 64(5)	113.95	0.641E-21	R(16) P
4	1291.272 49(5)*	626.56	0.170E-21	Q(9) C	39	1294.103 05(6)	401.46	0.260E-21	R(31) R
5	1291.279 47(5)*	702.77	0.672E-22	Q(16) B	40	1294.429 51(5)*	1443.43	0.582E-21	R(19) D
6	1291.317 58(5)*	619.00	0.197E-21	Q(8) C	41	1294.684 49(5)*	55.31	0.154E-18	R(11) A
7	1291.372 52(5)*	654.15	0.113E-21	Q(12) B	42	1294.799 22(5)	128.19	0.633E-21	R(17) P
8	1291.391 80(5)*	644.10	0.128E-21	Q(11) B	43	1294.806 15(6)	427.35	0.237E-21	R(32) R
9	1291.392 72(5)*	606.41	0.274E-21	Q(6) C	44	1294.817 05(5)*	593.80	0.354E-20	R(3) B
10	1291.409 47(5)*	634.88	0.147E-21	Q(10) B	45	1294.825 72(5)*	593.81	0.354E-20	R(3) C
11	1291.422 78(5)*	601.37	0.333E-21	Q(5) C	46	1295.194 21(5)*	1460.12	0.564E-21	R(20) D
12	1291.425 55(5)*	626.49	0.170E-21	Q(9) B	47	1295.476 56(5)*	65.36	0.159E-18	R(12) A
13	1291.440 02(5)*	618.95	0.197E-21	Q(8) B	48	1295.506 01(6)	454.04	0.214E-21	R(33) R
14	1291.447 83(5)*	597.17	0.417E-21	Q(4) C	49	1295.533 06(6)	1168.97	0.114E-21	R(1) G
15	1291.452 88(5)*	612.24	0.231E-21	Q(7) B	50	1295.566 01(5)	143.27	0.621E-21	R(18) P
16	1291.480 69(5)*	23.46	0.120E-18	R(7) A	51	1295.638 23(5)*	597.15	0.446E-20	R(4) B
17	1291.694 26(5)	76.25	0.634E-21	R(13) P	52	1295.649 65(5)*	597.17	0.445E-20	R(4) C
18	1291.964 63(13)	1195.39	0.275E-21	P(6) E	53	1295.955 57(5)*	1477.64	0.542E-21	R(21) D
19	1291.964 69(13)	1195.39	0.275E-21	P(6) F	54	1295.961 1	808.84	0.267E-22	R(23) S
20	1291.974 22(6)	328.64	0.333E-21	R(28) R	55	1296.200 25(7)	1945.53	0.339E-22	R(12) I
21	1292.115 41(4)*	1398.38	0.615E-21	R(16) D	56	1296.202 61(6)	481.55	0.193E-21	R(34) R
22	1292.286 96(5)*	30.17	0.131E-18	R(8) A	57	1296.265 07(5)*	76.25	0.163E-18	R(13) A
23	1292.476 16(5)	87.98	0.642E-21	R(14) P	58	1296.329 02(5)	159.19	0.605E-21	R(19) P
24	1292.687 08(6)	352.10	0.308E-21	R(29) R	59	1296.362 25(6)	1170.65	0.170E-21	R(2) G
25	1292.820 78(13)	1190.35	0.223E-21	P(5) E	60	1296.455 97(5)*	601.34	0.531E-20	R(5) B
26	1292.820 82(13)	1190.35	0.223E-21	P(5) F	61	1296.470 36(5)*	601.37	0.531E-20	R(5) C
27	1292.890 11(5)*	1412.57	0.608E-21	R(17) D	62	1296.895 97(6)	509.86	0.174E-21	R(35) R
28	1293.089 69(5)*	37.71	0.140E-18	R(9) A	63	1297.005 99(13)	1190.35	0.779E-22	Q(5) E
29	1293.164 37(5)*	589.61	0.145E-20	R(1) B	64	1297.006 09(13)	1190.35	0.779E-22	Q(5) F
30	1293.168 23(5)*	589.61	0.144E-20	R(1) C	65	1297.021 97(13)	1186.15	0.976E-22	Q(4) E
31	1293.396 69(6)	376.38	0.284E-21	R(30) R	66	1297.022 01(13)	1186.15	0.976E-22	Q(4) F
32	1293.661 48(5)*	1427.58	0.597E-21	R(18) D	67	1297.034 74(13)	1182.79	0.129E-21	Q(3) E
33	1293.673 77(13)	1186.15	0.162E-21	P(4) E	68	1297.034 75(13)	1182.79	0.129E-21	Q(3) F
34	1293.673 78(13)	1186.15	0.162E-21	P(4) F	69	1297.044 31(13)	1180.27	0.186E-21	Q(2) E
35	1293.888 87(5)*	46.09	0.148E-18	R(10) A	70	1297.044 31(13)	1180.27	0.186E-21	Q(2) F

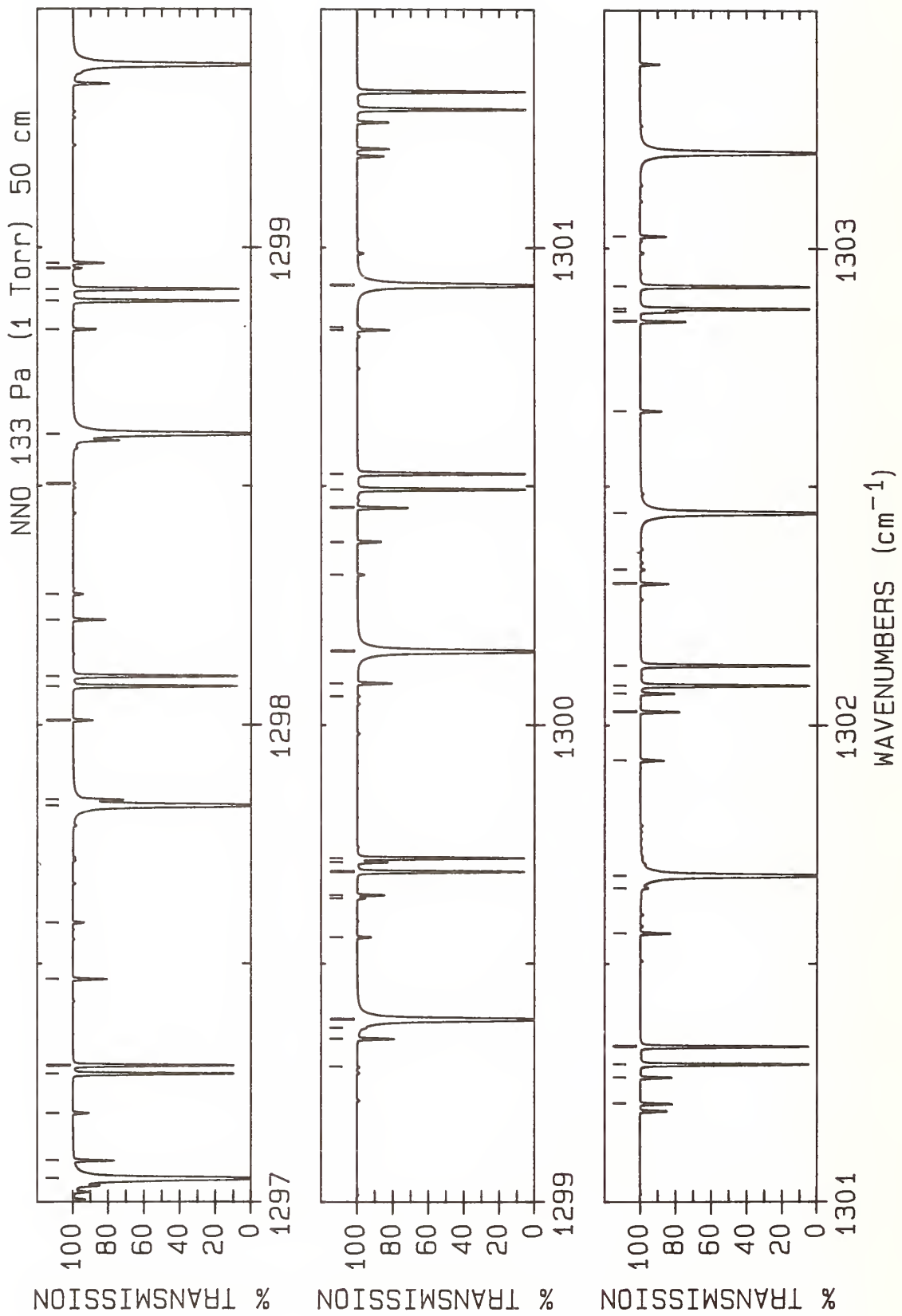

LINE #	WAVENUMBER(unc) (cm ⁻¹)	LOWER STATE (cm ⁻¹)	INTENSITY (cm/molecule)	ASSIGNMENT ROTATION BAND	LINE #	WAVENUMBER(unc) (cm ⁻¹)	LOWER STATE (cm ⁻¹)	INTENSITY (cm/molecule)	ASSIGNMENT ROTATION BAND
1	1297.050 02(5)*	87.98	0.165E-18	R(14) A	36	1300.314 06(7)	663.53	0.948E-22	R(40) R
2	1297.088 24(5)	175.94	0.586E-21	R(20) P	37	1300.382 95(13)	1182.79	0.166E-21	R(3) F
3	1297.187 88(6)	1173.17	0.224E-21	R(3) G	38	1300.382 96(13)	1182.79	0.166E-21	R(3) E
4	1297.270 25(5)*	606.37	0.610E-20	R(6) B	39	1300.453 79(6)*	1600.25	0.381E-21	R(27) D
5	1297.287 87(5)*	606.41	0.609E-20	R(6) C	40	1300.454 65(6)	1191.65	0.409E-21	R(7) G
6	1297.468 29(5)*	1515.18	0.493E-21	R(23) D	41	1300.492 81(5)*	634.88	0.845E-20	R(10) B
7	1297.586 08(7)	538.98	0.155E-21	R(36) R	42	1300.525 65(5)*	634.96	0.843E-20	R(10) C
8	1297.831 40(5)*	100.55	0.165E-18	R(15) A	43	1300.827 37(5)	272.26	0.454E-21	R(25) P
9	1297.843 66(5)	193.53	0.563E-21	R(21) P	44	1300.833 15(6)	2023.02	0.341E-22	R(18) H
10	1298.009 93(6)	1176.53	0.275E-21	R(4) G	45	1300.921 23(5)*	159.20	0.155E-18	R(19) A
11	1298.081 08(5)*	612.24	0.681E-20	R(7) B	46	1301.207 22(13)	1186.15	0.228E-21	R(4) F
12	1298.102 15(5)*	612.29	0.680E-20	R(7) C	47	1301.207 24(13)	1186.15	0.228E-21	R(4) E
13	1298.219 66(5)*	1535.19	0.466E-21	R(24) D	48	1301.262 39(6)	1198.37	0.445E-21	R(8) G
14	1298.272 94(7)	568.91	0.138E-21	R(37) R	49	1301.289 78(5)*	644.10	0.882E-20	R(11) B
15	1298.504 61(6)	1980.45	0.353E-22	R(15) H	50	1301.327 03(5)*	644.20	0.881E-20	R(11) C
16	1298.609 21(5)*	113.96	0.164E-18	R(16) A	51	1301.563 78(5)	294.04	0.424E-21	R(26) P
17	1298.828 42(6)	1180.73	0.324E-21	R(5) G	52	1301.658 60(7)	730.64	0.721E-22	R(42) R
18	1298.888 45(5)*	618.95	0.744E-20	R(8) B	53	1301.684 74(5)*	175.95	0.150E-18	R(20) A
19	1298.913 21(5)*	619.00	0.742E-20	R(8) C	54	1301.926 62(6)*	1647.79	0.324E-21	R(29) D
20	1298.956 56(7)	599.64	0.122E-21	R(38) R	55	1302.028 27(12)	1190.35	0.284E-21	R(5) F
21	1298.967 70(5)*	1556.05	0.438E-21	R(25) D	56	1302.028 31(12)	1190.35	0.284E-21	R(5) E
22	1299.284 07(6)	1993.80	0.352E-22	R(16) H	57	1302.066 53(5)	1205.92	0.477E-21	R(9) G
23	1299.343 13(5)	231.22	0.511E-21	R(23) P	58	1302.083 29(5)*	654.15	0.911E-20	R(12) B
24	1299.365 89(6)	1994.05	0.351E-22	R(16) I	59	1302.125 18(5)*	654.28	0.910E-20	R(12) C
25	1299.383 46(5)*	128.20	0.163E-18	R(17) A	60	1302.296 37(5)	316.65	0.393E-21	R(27) P
26	1299.555 48(13)	1180.27	0.932E-22	R(2) F	61	1302.326 02(7)	765.40	0.625E-22	R(43) R
27	1299.555 49(13)	1180.27	0.932E-22	R(2) E	62	1302.444 68(5)*	193.54	0.145E-18	R(21) A
28	1299.636 93(7)	631.18	0.108E-21	R(39) R	63	1302.658 06(6)*	1672.80	0.297E-21	R(30) D
29	1299.643 33(6)	1185.77	0.368E-21	R(6) G	64	1302.846 12(12)	1195.39	0.334E-21	R(6) F
30	1299.692 36(5)*	626.49	0.799E-20	R(9) B	65	1302.846 17(12)	1195.39	0.334E-21	R(6) E
31	1299.712 41(6)*	1577.73	0.410E-21	R(26) D	66	1302.867 08(5)	1214.32	0.503E-21	R(10) G
32	1299.721 05(5)*	626.56	0.797E-20	R(9) C	67	1302.873 32(5)*	665.05	0.932E-20	R(13) B
33	1300.060 25(6)	2007.99	0.348E-22	R(17) H	68	1302.920 10(5)*	665.20	0.930E-20	R(13) C
34	1300.087 15(5)	251.32	0.483E-21	R(24) P	69	1303.025 15(5)	340.10	0.364E-21	R(28) P
35	1300.154 13(5)*	143.28	0.159E-18	R(18) A					

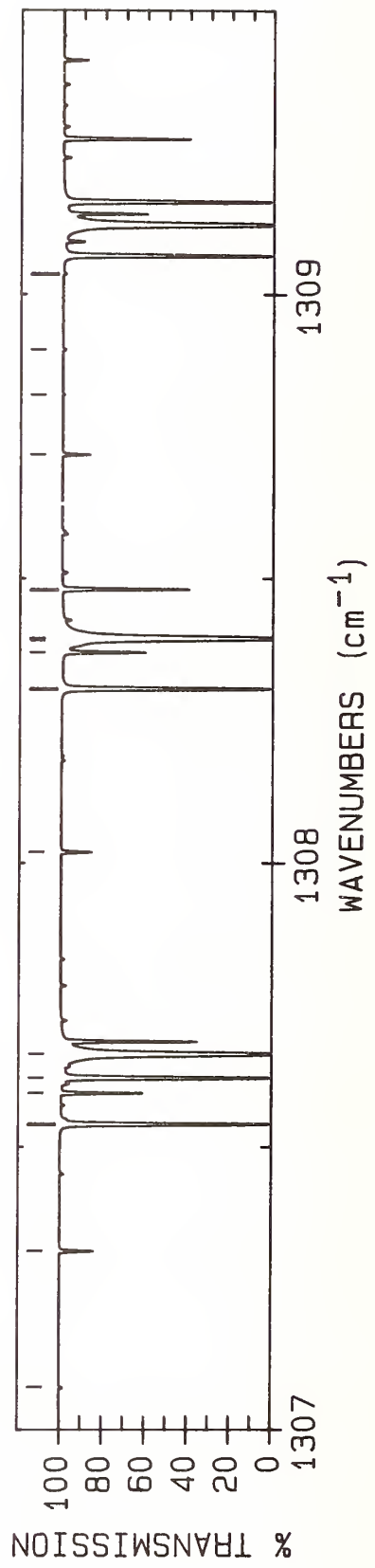
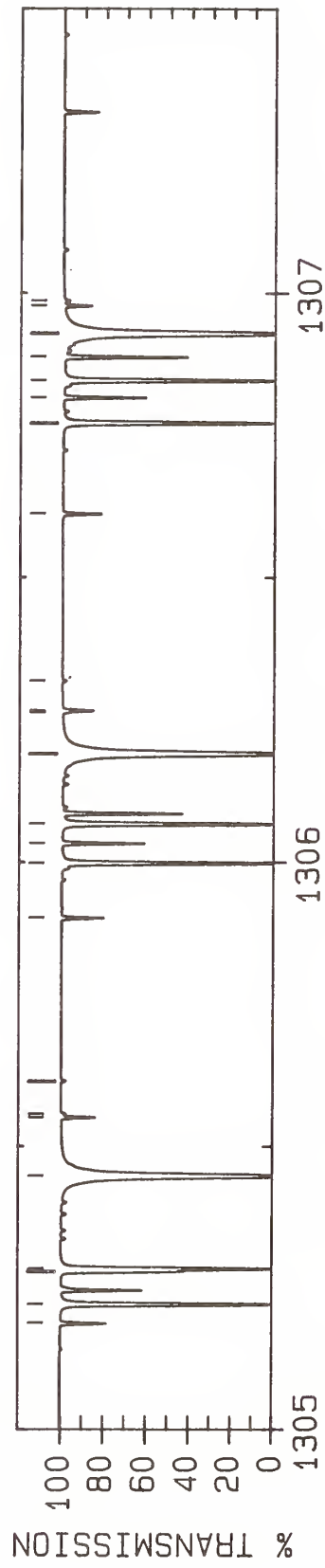
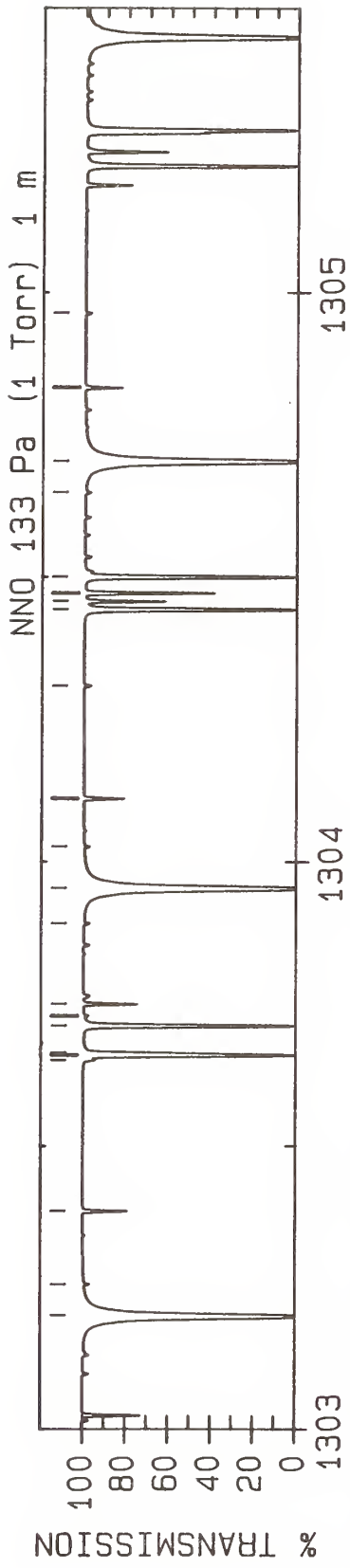

LINE #	WAVENUMBER(unc) (cm ⁻¹)	LOWER STATE (cm ⁻¹)	INTENSITY (cm/molecule)	ASSIGNMENT ROTATION BAND	LINE #	WAVENUMBER(unc) (cm ⁻¹)	LOWER STATE (cm ⁻¹)	INTENSITY (cm/molecule)	ASSIGNMENT ROTATION BAND
1	1303.201 04(5)*	211.97	0.138E-18	R(22) A	36	1305.901 99(5)	442.25	0.251E-21	R(32) P
2	1303.257 13(6)	2073.52	0.310E-22	R(21) I	37	1305.998 64(5)*	717.02	0.932E-20	R(17) B
3	1303.386 19(6)*	1698.65	0.270E-21	R(31) D	38	1306.033 21(5)	1256.31	0.559E-21	R(14) G
4	1303.651 16(7)	837.35	0.463E-22	R(45) R	39	1306.067 39(5)*	717.26	0.930E-20	R(17) C
5	1303.659 87(5)*	676.79	0.943E-20	R(14) B	40	1306.190 59(5)*	294.06	0.109E-18	R(26) A
6	1303.660 75(12)	1201.27	0.379E-21	R(7) F	41	1306.262 75(8)	990.92	0.241E-22	R(49) R
7	1303.660 83(12)	1201.27	0.379E-21	R(7) E	42	1306.265 73(6)*	1810.37	0.177E-21	R(35) D
8	1303.664 02(5)	1223.56	0.525E-21	R(11) G	43	1306.317 69(7)	2152.14	0.250E-22	R(25) I
9	1303.711 78(5)*	676.95	0.942E-20	R(14) C	44	1306.611 62(5)	469.88	0.226E-21	R(33) P
10	1303.729 10(36)	1772.56	0.243E-22	R(7) J	45	1306.771 26(5)*	732.11	0.914E-20	R(18) B
11	1303.750 10(5)	364.38	0.334E-21	R(29) P	46	1306.815 71(5)	1268.90	0.560E-21	R(15) G
12	1303.891 86(6)	2091.46	0.297E-22	R(22) H	47	1306.846 12(5)*	732.38	0.913E-20	R(18) C
13	1303.953 81(5)*	231.24	0.131E-18	R(23) A	48	1306.887 05(10)	1233.20	0.504E-21	R(11) F
14	1304.026 62(6)	2091.92	0.296E-22	R(22) I	49	1306.887 28(10)	1233.20	0.504E-21	R(11) E
15	1304.111 01(6)*	1725.33	0.245E-21	R(32) D	50	1306.929 01(5)*	316.67	0.101E-18	R(27) A
16	1304.308 89(7)	874.54	0.396E-22	R(46) R	51	1306.977 39(6)*	1840.38	0.157E-21	R(36) D
17	1304.442 95(5)*	689.36	0.947E-20	R(15) B	52	1306.986 48(32)	1804.64	0.315E-22	R(11) K
18	1304.457 36(5)	1233.63	0.541E-21	R(12) G	53	1307.075 59(7)	2173.88	0.233E-22	R(26) I
19	1304.471 23(5)	389.50	0.305E-21	R(30) P	54	1307.317 42(5)	498.34	0.203E-21	R(34) P
20	1304.472 16(11)	1207.99	0.418E-21	R(8) F	55	1307.540 38(5)*	748.03	0.891E-20	R(19) B
21	1304.472 27(11)	1207.99	0.418E-21	R(8) E	56	1307.594 59(5)	1282.33	0.557E-21	R(16) G
22	1304.500 22(5)*	689.55	0.945E-20	R(15) C	57	1307.621 60(5)*	748.33	0.889E-20	R(19) C
23	1304.648 32(7)	2110.65	0.282E-22	R(23) H	58	1307.663 83(5)*	340.12	0.934E-19	R(28) A
24	1304.702 99(5)*	251.34	0.124E-18	R(24) A	59	1308.019 37(6)	527.64	0.181E-21	R(35) P
25	1304.832 54(6)*	1752.85	0.221E-21	R(33) D	60	1308.306 01(5)*	764.79	0.862E-20	R(20) B
26	1304.963 39(8)	912.53	0.337E-22	R(47) R	61	1308.369 84(5)	1296.61	0.550E-21	R(17) G
27	1305.188 53(5)	415.46	0.278E-21	R(31) P	62	1308.390 91(7)*	1902.90	0.122E-21	R(38) D
28	1305.222 54(5)*	702.77	0.943E-20	R(16) B	63	1308.393 84(5)*	765.12	0.861E-20	R(20) C
29	1305.280 35(11)	1215.55	0.452E-21	R(9) F	64	1308.395 05(5)*	364.41	0.859E-19	R(29) A
30	1305.280 49(11)	1215.56	0.452E-21	R(9) E	65	1308.480 84(9)	1254.20	0.534E-21	R(13) F
31	1305.285 42(5)*	702.99	0.941E-20	R(16) C	66	1308.481 16(9)	1254.20	0.534E-21	R(13) E
32	1305.448 59(5)*	272.28	0.116E-18	R(25) A	67	1308.717 47(6)	557.77	0.161E-21	R(36) P
33	1305.550 78(6)*	1781.19	0.198E-21	R(34) D	68	1308.822 98(8)	1157.36	0.117E-22	R(53) R
34	1305.556 90(7)	2131.23	0.266E-22	R(24) I	69	1308.902 2	965.05	0.187E-22	R(30) N
35	1305.614 68(8)	951.32	0.286E-22	R(48) R	70	1309.036 0	965.80	0.186E-22	R(30) O

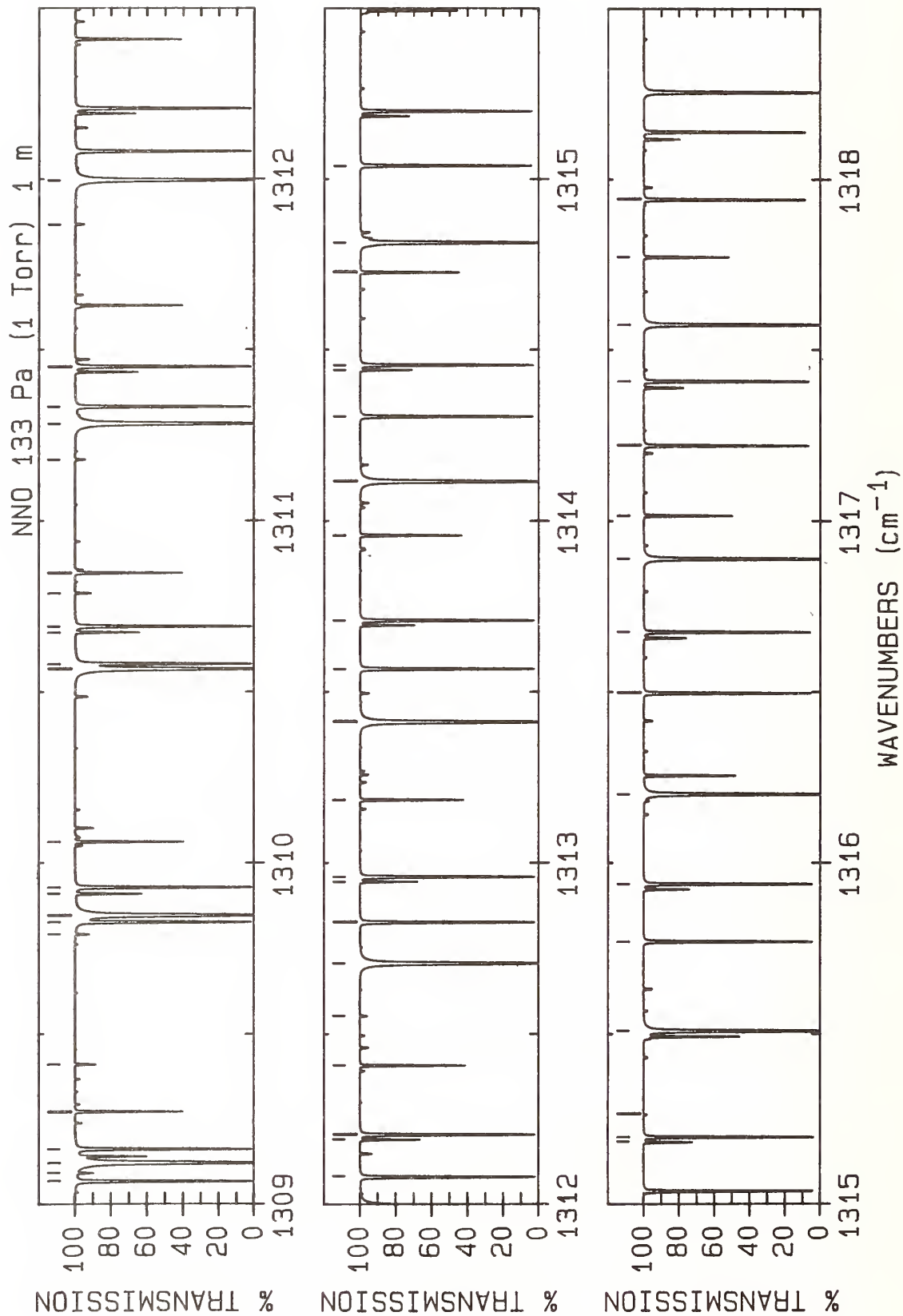

LINE #	WAVENUMBER(unc) (cm ⁻¹)	LOWER STATE (cm ⁻¹)	INTENSITY (cm/molecule)	ASSIGNMENT ROTATION BAND	LINE #	WAVENUMBER(unc) (cm ⁻¹)	LOWER STATE (cm ⁻¹)	INTENSITY (cm/molecule)	ASSIGNMENT ROTATION BAND
1	1309.068 14(5)*	782.39	0.829E-20	R(21) B	36	1312.945 05(6)	1399.85	0.442E-21	R(23) G
2	1309.092 77(7)*	1935.40	0.107E-21	R(39) D	37	1312.959 23(5)*	883.50	0.622E-20	R(26) C
3	1309.122 69(5)*	389.53	0.785E-19	R(30) A	38	1313.184 55(7)	1337.37	0.512E-21	R(19) F
4	1309.162 85(5)*	782.76	0.827E-20	R(21) C	39	1313.185 09(8)	1337.38	0.511E-21	R(19) E
5	1309.272 89(9)	1265.96	0.541E-21	R(14) F	40	1313.412 90(5)*	557.81	0.413E-19	R(36) A
6	1309.273 25(9)	1265.97	0.541E-21	R(14) E	41	1313.567 41(5)*	905.56	0.579E-20	R(27) B
7	1309.411 73(6)	588.74	0.142E-21	R(37) P	42	1313.708 79(5)*	906.16	0.578E-20	R(27) C
8	1309.791 38(7)*	1968.74	0.935E-22	R(40) D	43	1313.957 16(7)	1354.16	0.495E-21	R(20) F
9	1309.826 78(5)*	800.83	0.792E-20	R(22) B	44	1313.957 71(7)	1354.18	0.495E-21	R(20) E
10	1309.846 72(5)*	415.49	0.715E-19	R(31) A	45	1314.115 34(5)*	588.78	0.365E-19	R(37) A
11	1309.909 45(5)	1327.67	0.525E-21	R(19) G	46	1314.305 01(5)*	929.02	0.535E-20	R(28) B
12	1309.928 61(5)*	801.23	0.791E-20	R(22) C	47	1314.440 98(6)	1440.98	0.392E-21	R(25) G
13	1310.061 70(9)	1278.56	0.544E-21	R(15) F	48	1314.455 11(5)*	929.66	0.534E-20	R(28) C
14	1310.062 10(9)	1278.57	0.544E-21	R(15) E	49	1314.726 52(7)	1371.80	0.475E-21	R(21) F
15	1310.567 15(5)*	442.28	0.647E-19	R(32) A	50	1314.727 07(8)	1371.82	0.475E-21	R(21) E
16	1310.581 92(5)*	820.10	0.753E-20	R(23) B	51	1314.814 18(5)*	620.59	0.321E-19	R(38) A
17	1310.673 81(5)	1344.45	0.508E-21	R(20) G	52	1315.039 11(5)*	953.32	0.492E-20	R(29) B
18	1310.691 12(5)*	820.54	0.751E-20	R(23) C	53	1315.183 48(6)	1462.80	0.366E-21	R(26) G
19	1310.788 69(6)	653.18	0.109E-21	R(39) P	54	1315.198 19(5)*	954.01	0.490E-20	R(29) C
20	1310.847 27(8)	1292.01	0.542E-21	R(16) F	55	1315.264 38(7)*	2265.33	0.265E-22	R(48) D
21	1310.847 72(8)	1292.01	0.542E-21	R(16) E	56	1315.509 41(5)*	653.23	0.281E-19	R(39) A
22	1311.178 89(7)*	2037.90	0.701E-22	R(42) D	57	1315.769 68(5)*	978.45	0.449E-20	R(30) B
23	1311.283 99(5)*	469.91	0.583E-19	R(33) A	58	1315.938 04(5)*	979.18	0.448E-20	R(30) C
24	1311.333 55(5)*	840.21	0.711E-20	R(24) B	59	1316.201 05(5)*	686.70	0.244E-19	R(40) A
25	1311.450 40(5)*	840.68	0.710E-20	R(24) C	60	1316.496 75(5)*	1004.42	0.409E-20	R(31) B
26	1311.867 80(7)*	2073.73	0.603E-22	R(43) D	61	1316.674 66(5)*	1005.20	0.408E-20	R(31) C
27	1311.997 23(5)*	498.37	0.522E-19	R(34) A	62	1316.889 09(5)*	721.01	0.212E-19	R(41) A
28	1312.081 68(5)*	861.16	0.668E-20	R(25) B	63	1317.015 15(8)	1429.76	0.406E-21	R(24) F
29	1312.191 61(6)	1380.55	0.466E-21	R(22) G	64	1317.015 57(8)	1429.78	0.406E-21	R(24) E
30	1312.206 44(5)*	861.67	0.666E-20	R(25) C	65	1317.220 30(5)*	1031.22	0.370E-20	R(32) B
31	1312.408 70(8)	1321.41	0.525E-21	R(18) F	66	1317.408 04(5)*	1032.06	0.369E-20	R(32) C
32	1312.409 21(8)	1321.41	0.525E-21	R(18) E	67	1317.573 52(5)*	756.16	0.183E-19	R(42) A
33	1312.553 50(7)*	2110.39	0.516E-22	R(44) D	68	1317.771 53(8)	1450.75	0.381E-21	R(25) F
34	1312.706 87(5)*	527.67	0.466E-19	R(35) A	69	1317.771 87(9)	1450.78	0.381E-21	R(25) E
35	1312.826 30(5)*	882.94	0.623E-20	R(26) B	70	1317.940 33(5)*	1058.86	0.333E-20	R(33) B

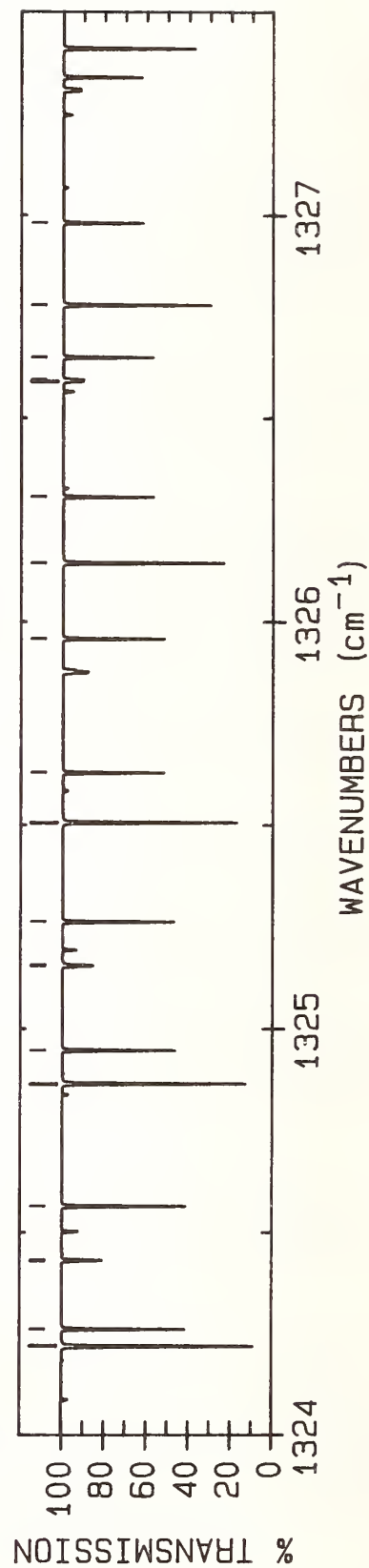
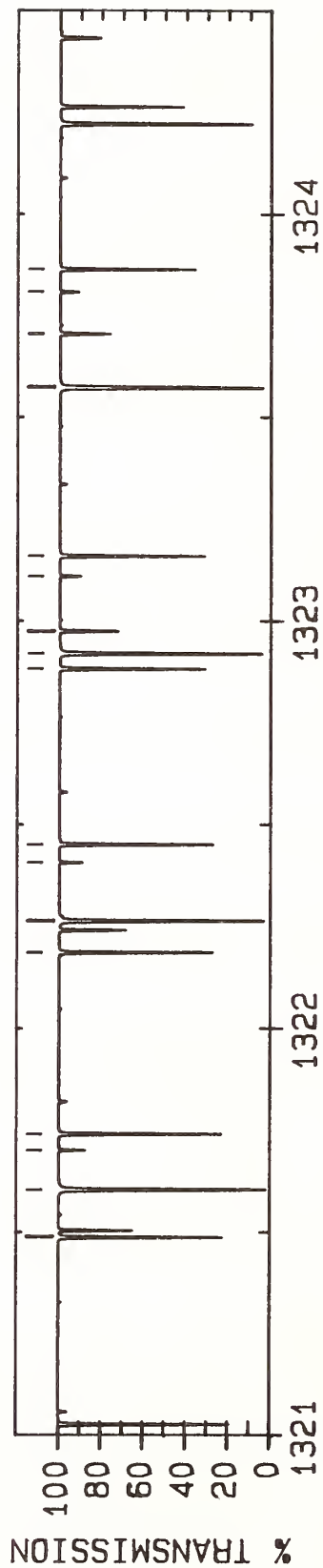
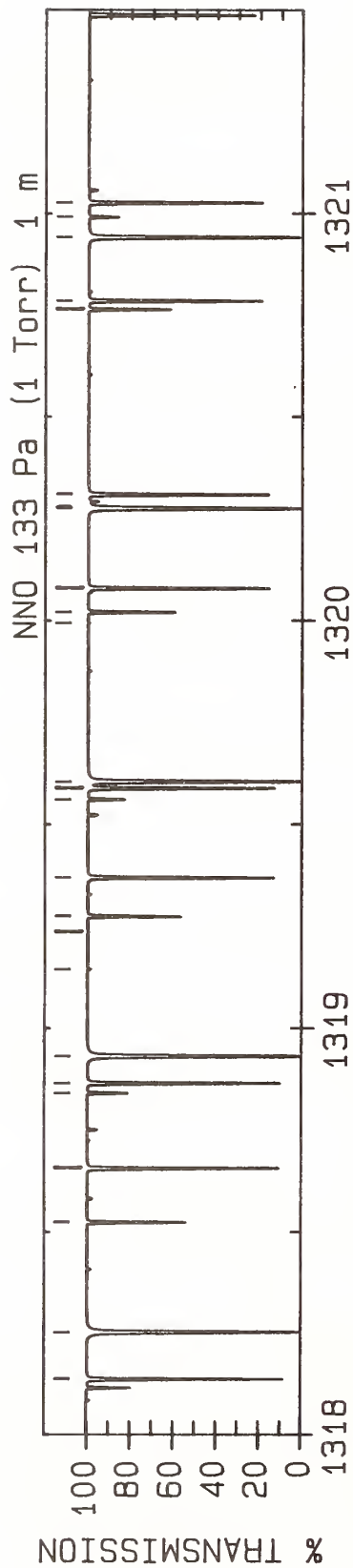

LINE #	WAVENUMBER(unc) (cm ⁻¹)	LOWER STATE (cm ⁻¹)	INTENSITY (cm/molecule)	ASSIGNMENT ROTATION BAND	LINE #	WAVENUMBER(unc) (cm ⁻¹)	LOWER STATE (cm ⁻¹)	INTENSITY (cm/molecule)	ASSIGNMENT ROTATION BAND
1	1318.138 20(5)*	1059.75	0.332E-20	R(33) C	36	1322.407 23(6)	1727.03	0.137E-21	R(36) G
2	1318.254 36(5)*	792.14	0.157E-19	R(43) A	37	1322.451 54(5)*	1243.48	0.160E-20	R(39) C
3	1318.524 66(9)	1472.58	0.355E-21	R(26) F	38	1322.882 06(5)*	1275.74	0.139E-20	R(40) B
4	1318.524 89(9)	1472.61	0.355E-21	R(26) E	39	1322.919 60(5)*	1067.33	0.476E-20	R(50) A
5	1318.656 85(5)*	1087.34	0.298E-20	R(34) B	40	1322.973 99(12)	1621.26	0.208E-21	R(32) E
6	1318.841 12(6)	1584.45	0.239E-21	R(31) G	41	1322.975 30(11)	1621.19	0.208E-21	R(32) F
7	1318.865 14(5)*	1088.28	0.298E-20	R(34) C	42	1323.109 45(6)	1758.06	0.121E-21	R(37) G
8	1318.931 60(5)*	828.95	0.134E-19	R(44) A	43	1323.159 20(6)*	1277.04	0.139E-20	R(40) C
9	1319.144 93(35)	2066.15	0.207E-22	R(27) J	44	1323.571 71(5)*	1109.98	0.395E-20	R(51) A
10	1319.236 41(8)*	2522.63	0.855E-23	R(54) D	45	1323.573 95(6)*	1310.06	0.121E-20	R(41) B
11	1319.274 55(9)	1495.26	0.329E-21	R(27) F	46	1323.703 97(12)	1648.97	0.187E-21	R(33) E
12	1319.274 63(9)	1495.29	0.329E-21	R(27) E	47	1323.705 72(12)	1648.90	0.187E-21	R(33) F
13	1319.369 85(5)*	1116.65	0.266E-20	R(35) B	48	1323.808 00(6)	1789.92	0.106E-21	R(38) G
14	1319.561 67(6)	1611.29	0.216E-21	R(32) G	49	1323.863 66(6)*	1311.42	0.120E-20	R(41) C
15	1319.588 85(5)*	1117.64	0.265E-20	R(35) C	50	1324.220 24(5)*	1153.46	0.325E-20	R(52) A
16	1319.605 25(5)*	866.60	0.114E-19	R(45) A	51	1324.262 31(6)*	1345.22	0.104E-20	R(42) B
17	1319.994 11(8)	1197.68	0.103E-22	R(53) P	52	1324.430 65(13)	1677.52	0.167E-21	R(34) E
18	1320.021 08(10)	1518.81	0.304E-21	R(28) E	53	1324.432 89(12)	1677.44	0.167E-21	R(34) F
19	1320.021 20(9)	1518.77	0.304E-21	R(28) F	54	1324.564 93(6)*	1346.65	0.104E-20	R(42) C
20	1320.079 33(5)*	1146.80	0.236E-20	R(36) B	55	1324.865 19(5)*	1197.77	0.267E-20	R(53) A
21	1320.275 30(5)*	905.08	0.968E-20	R(46) A	56	1324.947 16(6)*	1381.21	0.893E-21	R(43) B
22	1320.278 56(6)	1638.97	0.194E-21	R(33) G	57	1325.154 02(13)	1706.91	0.149E-21	R(35) E
23	1320.309 34(5)*	1147.85	0.235E-20	R(36) C	58	1325.156 82(13)	1706.82	0.149E-21	R(35) F
24	1320.764 25(10)	1543.16	0.279E-21	R(29) E	59	1325.263 01(6)*	1382.71	0.891E-21	R(43) C
25	1320.764 59(10)	1543.12	0.279E-21	R(29) F	60	1325.506 57(5)*	1242.91	0.218E-20	R(54) A
26	1320.785 29(5)*	1177.78	0.208E-20	R(37) B	61	1325.628 49(6)*	1418.04	0.763E-21	R(44) B
27	1320.941 76(5)*	944.39	0.816E-20	R(47) A	62	1325.957 91(6)*	1419.61	0.761E-21	R(44) C
28	1320.991 78(6)	1667.49	0.174E-21	R(34) G	63	1326.144 38(5)*	1288.88	0.178E-20	R(55) A
29	1321.026 62(5)*	1178.89	0.208E-20	R(37) C	64	1326.306 30(6)*	1455.70	0.649E-21	R(45) B
30	1321.487 73(5)*	1209.60	0.183E-20	R(38) B	65	1326.590 83(14)	1768.20	0.116E-21	R(37) E
31	1321.604 63(5)*	984.54	0.685E-20	R(48) A	66	1326.594 96(13)	1768.08	0.116E-21	R(37) F
32	1321.701 34(6)	1696.84	0.155E-21	R(35) G	67	1326.649 63(6)*	1457.34	0.647E-21	R(45) C
33	1321.740 68(5)*	1210.77	0.183E-20	R(38) C	68	1326.778 62(5)*	1335.69	0.144E-20	R(56) A
34	1322.186 66(5)*	1242.25	0.160E-20	R(39) B	69	1326.980 59(6)*	1494.20	0.549E-21	R(46) B
35	1322.263 91(5)*	1025.52	0.573E-20	R(49) A					

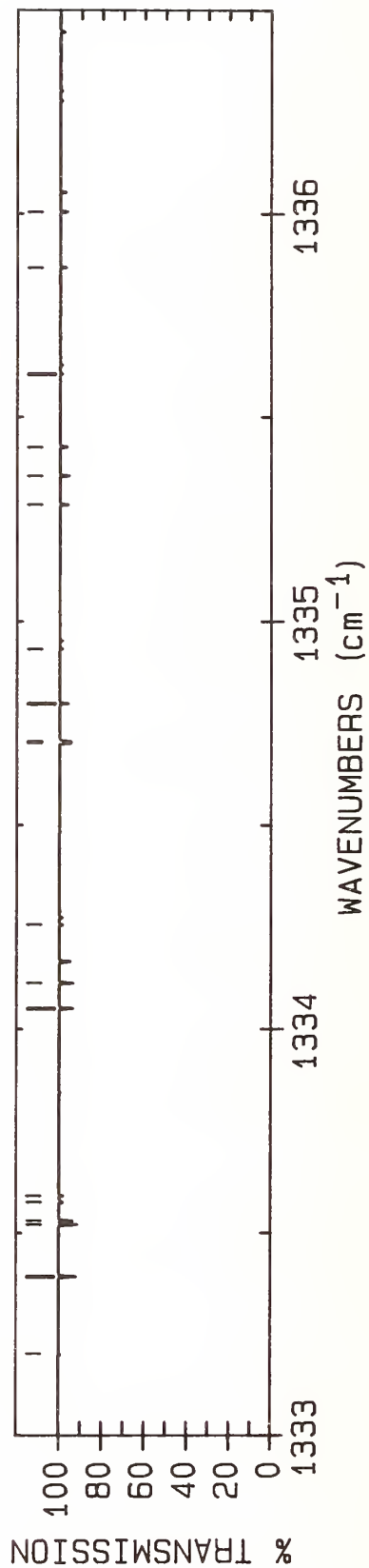
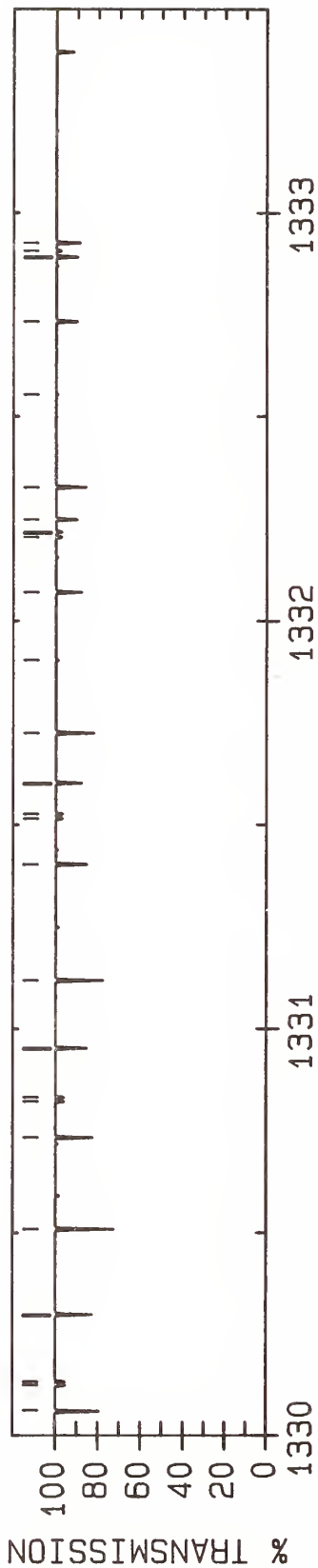
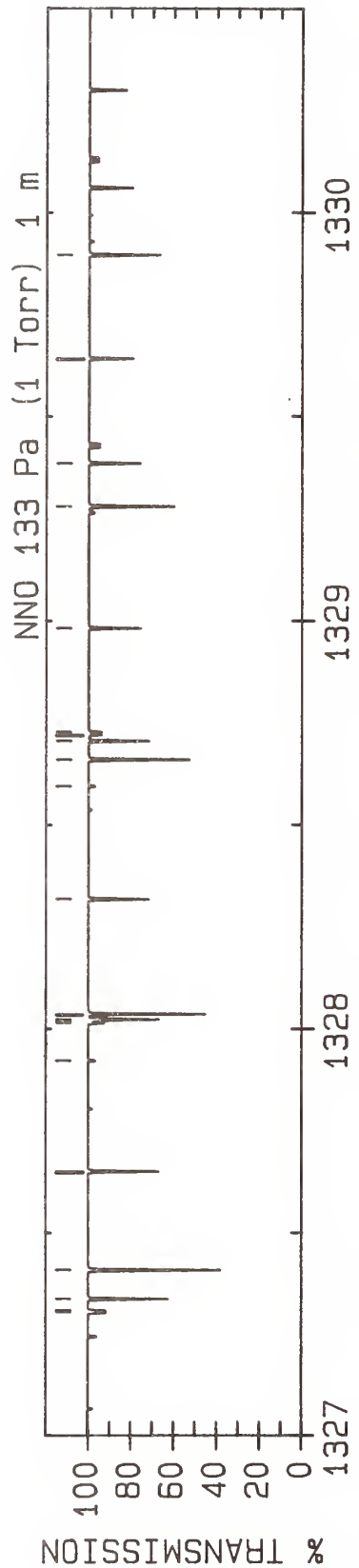

LINE #	WAVENUMBER(unc) (cm ⁻¹)	LOWER STATE (cm ⁻¹)	INTENSITY (cm/molecule)	ASSIGNMENT ROTATION BAND	LINE #	WAVENUMBER(unc) (cm ⁻¹)	LOWER STATE (cm ⁻¹)	INTENSITY (cm/molecule)	ASSIGNMENT ROTATION BAND
1	1327.304 27(14)	1800.10	0.102E-21	R(38) E	36	1331.724 77(5)*	1740.04	0.229E-21	R(64) A
2	1327.309 17(14)	1799.97	0.102E-21	R(38) F	37	1331.903 57(8)	2237.36	0.155E-22	R(50) G
3	1327.338 19(6)*	1495.90	0.548E-21	R(46) C	38	1332.070 00(6)*	1789.25	0.151E-21	R(53) C
4	1327.409 30(5)*	1383.33	0.116E-20	R(57) A	39	1332.205 33(14)	2046.86	0.352E-22	R(45) E
5	1327.651 38(6)*	1533.53	0.463E-21	R(47) B	40	1332.218 18(19)	2046.63	0.352E-22	R(45) F
6	1327.922 12(7)	1998.62	0.442E-22	R(44) G	41	1332.248 55(6)*	1832.15	0.123E-21	R(54) B
7	1328.014 38(14)	1832.84	0.885E-22	R(39) E	42	1332.327 15(5)*	1794.32	0.179E-21	R(65) A
8	1328.020 14(14)	1832.70	0.886E-22	R(39) F	43	1332.554 20(8)	2280.07	0.129E-22	R(51) G
9	1328.023 58(6)*	1535.31	0.462E-21	R(47) C	44	1332.733 48(6)*	1834.50	0.123E-21	R(54) C
10	1328.036 42(5)*	1431.79	0.934E-21	R(58) A	45	1332.891 28(6)*	1878.14	0.100E-21	R(55) B
11	1328.318 64(6)*	1573.69	0.388E-21	R(48) B	46	1332.892 19(14)	2085.47	0.297E-22	R(46) E
12	1328.594 92(7)	2036.33	0.375E-22	R(45) G	47	1332.906 57(20)	2085.21	0.297E-22	R(46) F
13	1328.659 99(5)*	1481.09	0.747E-21	R(59) A	48	1332.926 03(5)*	1849.42	0.139E-21	R(66) A
14	1328.705 83(6)*	1575.55	0.387E-21	R(48) C	49	1333.201 13(8)	2323.60	0.106E-22	R(52) G
15	1328.721 18(14)	1866.41	0.768E-22	R(40) E	50	1333.393 88(6)*	1880.57	0.100E-21	R(55) C
16	1328.727 89(15)	1866.26	0.769E-22	R(40) F	51	1333.521 40(5)*	1905.36	0.107E-21	R(67) A
17	1328.982 40(6)*	1614.68	0.324E-21	R(49) B	52	1333.530 50(6)*	1924.97	0.811E-22	R(56) B
18	1329.280 02(5)*	1531.22	0.595E-21	R(60) A	53	1333.575 72(14)	2124.90	0.249E-22	R(47) E
19	1329.384 92(6)*	1616.62	0.324E-21	R(49) C	54	1333.591 76(22)	2124.63	0.250E-22	R(47) F
20	1329.642 64(6)*	1656.51	0.270E-21	R(50) B	55	1334.051 19(6)*	1927.48	0.809E-22	R(56) C
21	1329.896 50(5)*	1582.18	0.472E-21	R(61) A	56	1334.113 29(5)*	1962.12	0.824E-22	R(68) A
22	1330.060 87(6)*	1658.53	0.269E-21	R(50) C	57	1334.255 94(15)	2165.18	0.208E-22	R(48) E
23	1330.124 81(14)	1936.08	0.570E-22	R(42) E	58	1334.701 70(5)*	2019.71	0.632E-22	R(69) A
24	1330.133 68(16)	1935.90	0.571E-22	R(42) F	59	1334.705 44(6)*	1975.23	0.653E-22	R(57) C
25	1330.299 38(6)*	1699.17	0.223E-21	R(51) B	60	1334.798 49(6)*	2021.11	0.525E-22	R(58) B
26	1330.509 45(5)*	1633.97	0.372E-21	R(62) A	61	1334.932 84(15)	2206.29	0.173E-22	R(49) E
27	1330.733 70(6)*	1701.27	0.223E-21	R(51) C	62	1335.286 63(5)*	2078.13	0.482E-22	R(70) A
28	1330.821 64(14)	1972.17	0.488E-22	R(43) E	63	1335.356 62(6)*	2023.80	0.524E-22	R(58) C
29	1330.831 74(17)	1971.97	0.488E-22	R(43) F	64	1335.427 25(6)*	2070.42	0.420E-22	R(59) B
30	1330.952 60(6)*	1742.67	0.184E-21	R(52) B	65	1335.606 41(16)	2248.24	0.144E-22	R(50) E
31	1331.118 87(5)*	1686.59	0.293E-21	R(63) A	66	1335.868 11(5)*	2137.38	0.366E-22	R(71) A
32	1331.403 40(6)*	1744.84	0.183E-21	R(52) C	67	1336.004 76(6)*	2073.21	0.419E-22	R(59) C
33	1331.515 15(14)	2009.10	0.415E-22	R(44) E					
34	1331.526 57(18)	2008.88	0.416E-22	R(44) F					
35	1331.602 33(6)*	1786.99	0.151E-21	R(53) B					

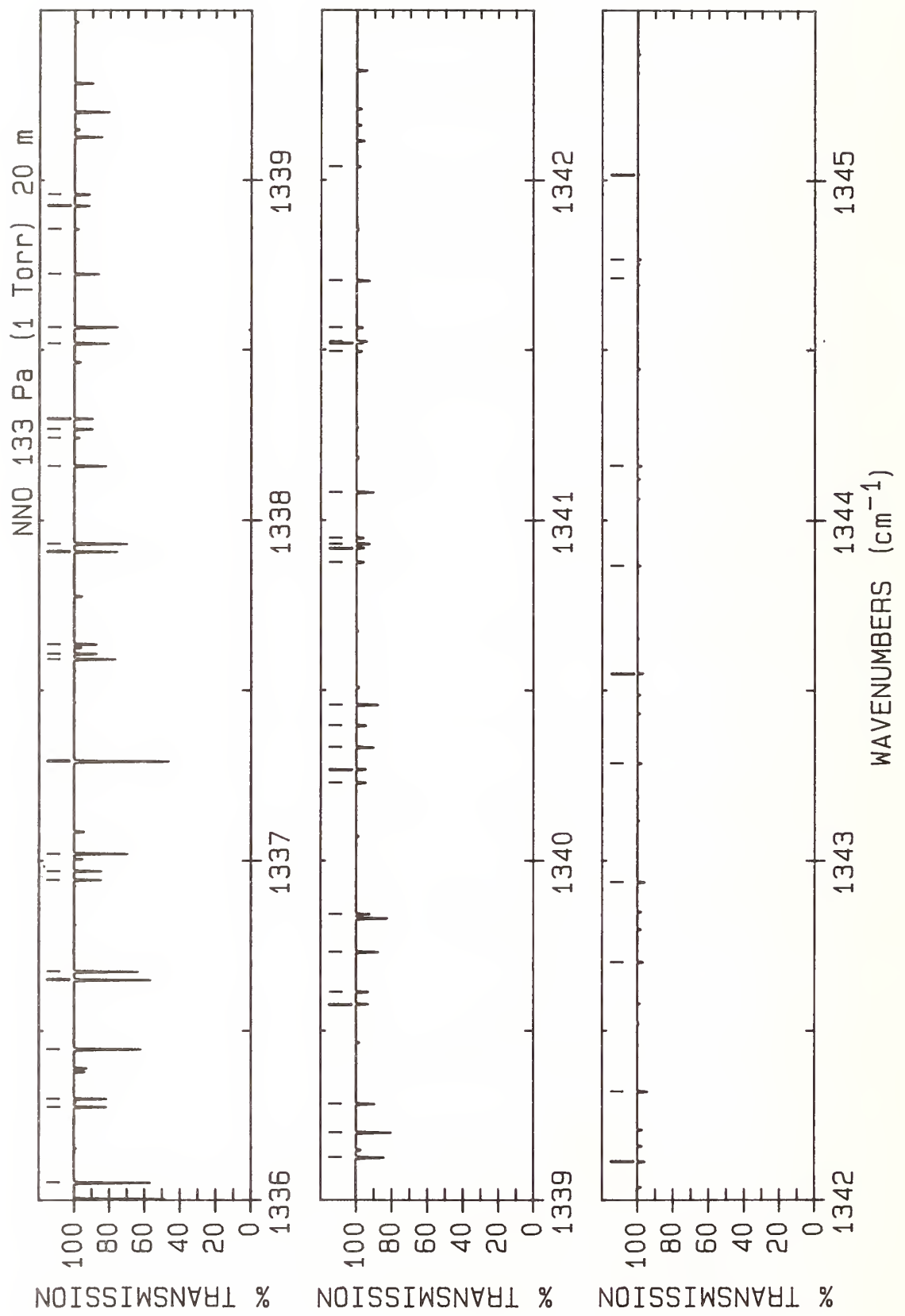

LINE #	WAVENUMBER(unc) (cm ⁻¹)	LOWER STATE (cm ⁻¹)	INTENSITY (cm/molecule)	ASSIGNMENT ROTATION BAND	LINE #	WAVENUMBER(unc) (cm ⁻¹)	LOWER STATE (cm ⁻¹)	INTENSITY (cm/molecule)	ASSIGNMENT ROTATION BAND
1	1336.052 53(6)*	2120.57	0.334E-22	R(60) B	31	1339.614 48(53)	2516.94	0.422E-23	R(56) F
2	1336.276 68(17)	2291.02	0.118E-22	R(51) E	32	1339.731 37(6)*	2438.88	0.774E-23	R(66) B
3	1336.300 42(32)	2290.64	0.119E-22	R(51) F	33	1339.842 45(6)*	2575.26	0.476E-23	R(78) A
4	1336.446 13(5)*	2197.45	0.277E-22	R(72) A	34	1340.228 94(34)	2565.26	0.338E-23	R(57) E
5	1336.649 86(6)*	2123.45	0.333E-22	R(60) C	35	1340.267 78(58)	2564.70	0.339E-23	R(57) F
6	1336.674 33(6)*	2171.55	0.264E-22	R(61) B	36	1340.332 42(6)*	2494.84	0.597E-23	R(67) B
7	1336.943 64(19)	2334.64	0.971E-23	R(52) E	37	1340.396 65(6)*	2641.11	0.349E-23	R(79) A
8	1336.969 60(35)	2334.23	0.974E-23	R(52) F	38	1340.457 50(6)*	2442.37	0.772E-23	R(66) C
9	1337.020 71(5)*	2258.36	0.209E-22	R(73) A	39	1340.876 15(38)	2613.89	0.270E-23	R(58) E
10	1337.291 94(6)*	2174.53	0.264E-22	R(61) C	40	1340.917 92(64)	2613.29	0.271E-23	R(58) F
11	1337.292 66(6)*	2223.36	0.209E-22	R(62) B	41	1340.930 03(6)*	2551.62	0.459E-23	R(68) B
12	1337.591 86(6)*	2320.08	0.157E-22	R(74) A	42	1340.947 51(6)*	2707.79	0.256E-23	R(80) A
13	1337.607 29(21)	2379.09	0.793E-23	R(53) E	43	1341.081 75(6)*	2498.43	0.596E-23	R(67) C
14	1337.635 58(39)	2378.66	0.796E-23	R(53) F	44	1341.495 04(6)*	2775.30	0.186E-23	R(81) A
15	1337.907 53(6)*	2275.99	0.164E-22	R(63) B	45	1341.520 10(43)	2663.35	0.214E-23	R(59) E
16	1337.931 01(6)*	2226.43	0.208E-22	R(62) C	46	1341.524 21(6)*	2609.24	0.351E-23	R(69) B
17	1338.159 60(6)*	2382.64	0.117E-22	R(75) A	47	1341.564 91(71)	2662.72	0.215E-23	R(59) F
18	1338.242 59(9)	2701.85	0.191E-23	R(60) G	48	1341.703 09(6)*	2555.32	0.458E-23	R(68) C
19	1338.267 63(24)	2424.38	0.645E-23	R(54) E	49	1342.039 26(6)*	2843.63	0.135E-23	R(82) A
20	1338.298 39(43)	2423.92	0.647E-23	R(54) F	50	1342.114 96(6)*	2667.68	0.268E-23	R(70) B
21	1338.518 93(6)*	2329.46	0.128E-22	R(64) B	51	1342.321 53(6)*	2613.04	0.351E-23	R(69) C
22	1338.567 09(6)*	2279.17	0.164E-22	R(63) C	52	1342.702 30(6)*	2726.94	0.203E-23	R(71) B
23	1338.723 93(6)*	2446.02	0.870E-23	R(76) A	53	1342.937 09(6)*	2671.59	0.267E-23	R(70) C
24	1338.855 95(10)	2752.87	0.151E-23	R(61) G	54	1343.286 23(6)*	2787.04	0.154E-23	R(72) B
25	1338.924 69(27)	2470.51	0.522E-23	R(55) E	55	1343.549 78(6)*	2730.97	0.203E-23	R(71) C
26	1338.958 02(48)	2470.01	0.524E-23	R(55) F	56	1343.866 76(6)*	2847.96	0.116E-23	R(73) B
27	1339.126 87(6)*	2383.76	0.998E-23	R(65) B	57	1344.159 64(6)*	2791.17	0.153E-23	R(72) C
28	1339.200 19(6)*	2332.74	0.128E-22	R(64) C	58	1344.711 29(6)*	3197.62	0.255E-24	R(87) A
29	1339.284 88(6)*	2510.22	0.645E-23	R(77) A	59	1344.766 68(6)*	2852.21	0.115E-23	R(73) C
30	1339.578 46(30)	2517.47	0.421E-23	R(56) E	60	1345.017 65(6)*	2972.28	0.647E-24	R(75) B

ATLAS OF N₂O ABSORPTION LINES FROM 1820 cm⁻¹ to 1925 cm⁻¹

key:

Band	Isotopomer	Vibrational Transition
A	¹⁴ N ¹⁴ N ¹⁶ O	01 ¹ 1-00 ⁰ 0
B		02 ² 1-01 ^{1e} 0
C		02 ² 1-01 ^{1f} 0
D		01 ¹ 2-00 ⁰ 1
E		03 ³ 1-02 ^{2e} 0
F		03 ³ 1-02 ^{2f} 0
G		03 ¹ 1-02 ⁰ 0
H		02 ⁰ 1-01 ¹ 0
I		03 ¹ 1-02 ^{2e} 0
J		03 ¹ 1-02 ^{2f} 0
P	¹⁴ N ¹⁵ N ¹⁶ O	01 ¹ 1-00 ⁰ 0
R	¹⁵ N ¹⁴ N ¹⁶ O	01 ¹ 1-00 ⁰ 0
T	¹⁴ N ¹⁴ N ¹⁸ O	01 ¹ 1-00 ⁰ 0

If the e or f designation is not specified (for $l \neq 0$), then the transition is to either level, depending on the selection rules and the change in the rotational quantum number, J . Spectra are given for a slitwidth of 0.002 cm⁻¹ and a transition moment of 0.00548 debye at a temperature of 296 K. For the H band a transition moment of 0.00406 debye was used. A Herman-Wallis constant of $\xi_1 = -0.0107$ is included in the intensity calculation for the lines of all bands.

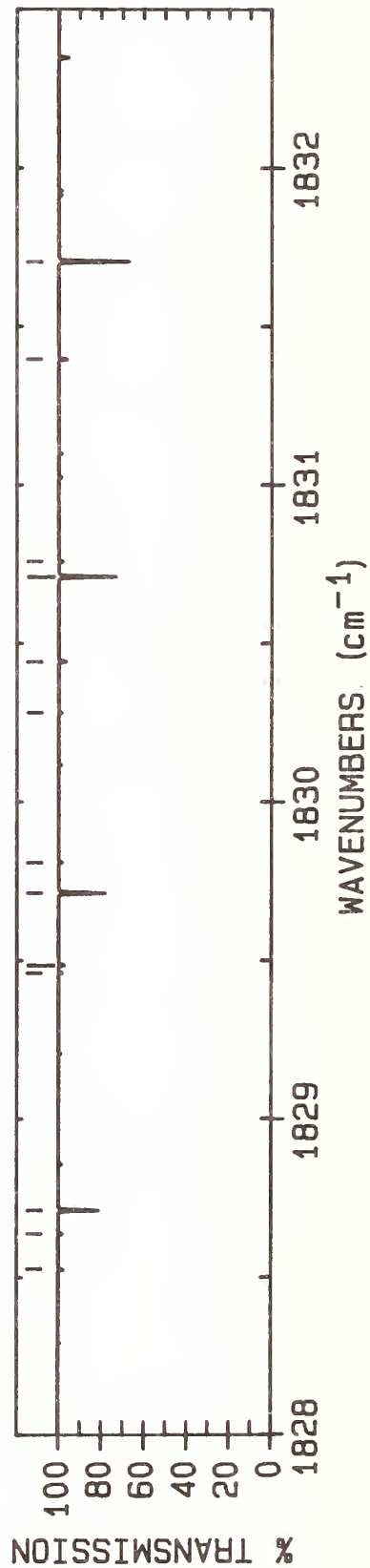
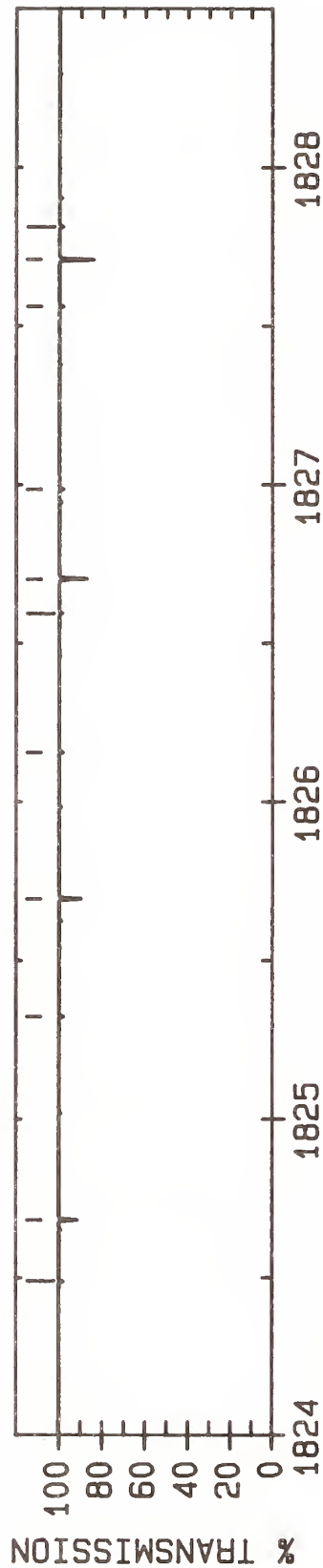
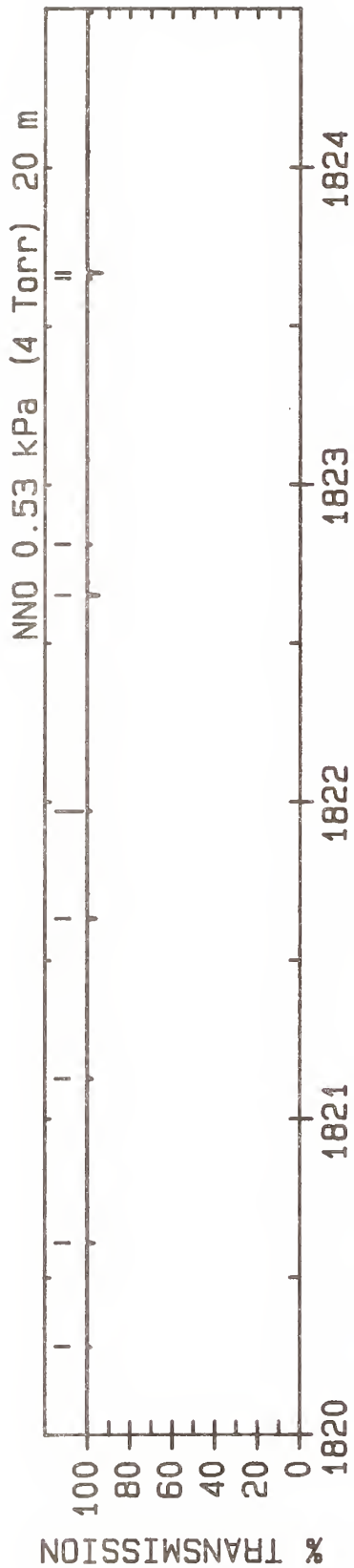

LINE #	WAVENUMBER(unc) (cm ⁻¹)	LOWER STATE (cm ⁻¹)	INTENSITY (cm/molecule)	ASSIGNMENT ROTATION BAND	LINE #	WAVENUMBER(unc) (cm ⁻¹)	LOWER STATE (cm ⁻¹)	INTENSITY (cm/molecule)	ASSIGNMENT ROTATION BAND
1	1820.280 7	237.29	0.441E-24	P(24) T	21	1828.525 73(44)	1656.51	0.544E-24	P(50) H
2	1820.610 57(14)*	1740.04	0.772E-24	P(64) A	22	1828.638 4	83.06	0.444E-24	P(14) T
3	1821.127 1	218.31	0.455E-24	P(23) T	23	1828.712 90(11)*	1335.69	0.435E-23	P(56) A
4	1821.632 91(14)*	1686.59	0.973E-24	P(63) A	24	1829.461 0	71.99	0.424E-24	P(13) T
5	1821.971 1	200.12	0.466E-24	P(22) T	25	1829.485 88(40)	1614.68	0.640E-24	P(49) H
6	1822.652 54(13)*	1633.97	0.122E-23	P(62) A	26	1829.713 30(10)*	1288.88	0.530E-23	P(55) A
7	1822.812 8	182.72	0.475E-24	P(21) T	27	1829.810 6	498.34	0.406E-24	P(34) P
8	1823.652 2	166.12	0.481E-24	P(20) T	28	1830.281 3	61.71	0.401E-24	P(12) T
9	1823.669 45(13)*	1582.18	0.153E-23	P(61) A	29	1830.442 78(37)	1573.69	0.750E-24	P(48) H
10	1824.489 1	150.30	0.484E-24	P(19) T	30	1830.710 92(10)*	1242.91	0.642E-23	P(54) A
11	1824.683 63(12)*	1531.22	0.190E-23	P(60) A	31	1830.759 1	469.88	0.445E-24	P(33) P
12	1825.323 7	135.27	0.483E-24	P(18) T	32	1831.396 47(34)	1533.53	0.874E-24	P(47) H
13	1825.695 08(12)*	1481.09	0.235E-23	P(59) A	33	1831.704 3	442.25	0.486E-24	P(32) P
14	1826.156 0	121.03	0.479E-24	P(17) T	34	1831.705 75(9)*	1197.77	0.774E-23	P(53) A
15	1826.595 57(54)	1742.67	0.387E-24	P(52) H					
16	1826.703 78(11)*	1431.79	0.290E-23	P(58) A					
17	1826.985 8	107.58	0.471E-24	P(16) T					
18	1827.562 31(49)	1699.17	0.460E-24	P(51) H					
19	1827.709 72(11)*	1383.33	0.356E-23	P(57) A					
20	1827.813 3	94.93	0.459E-24	P(15) T					

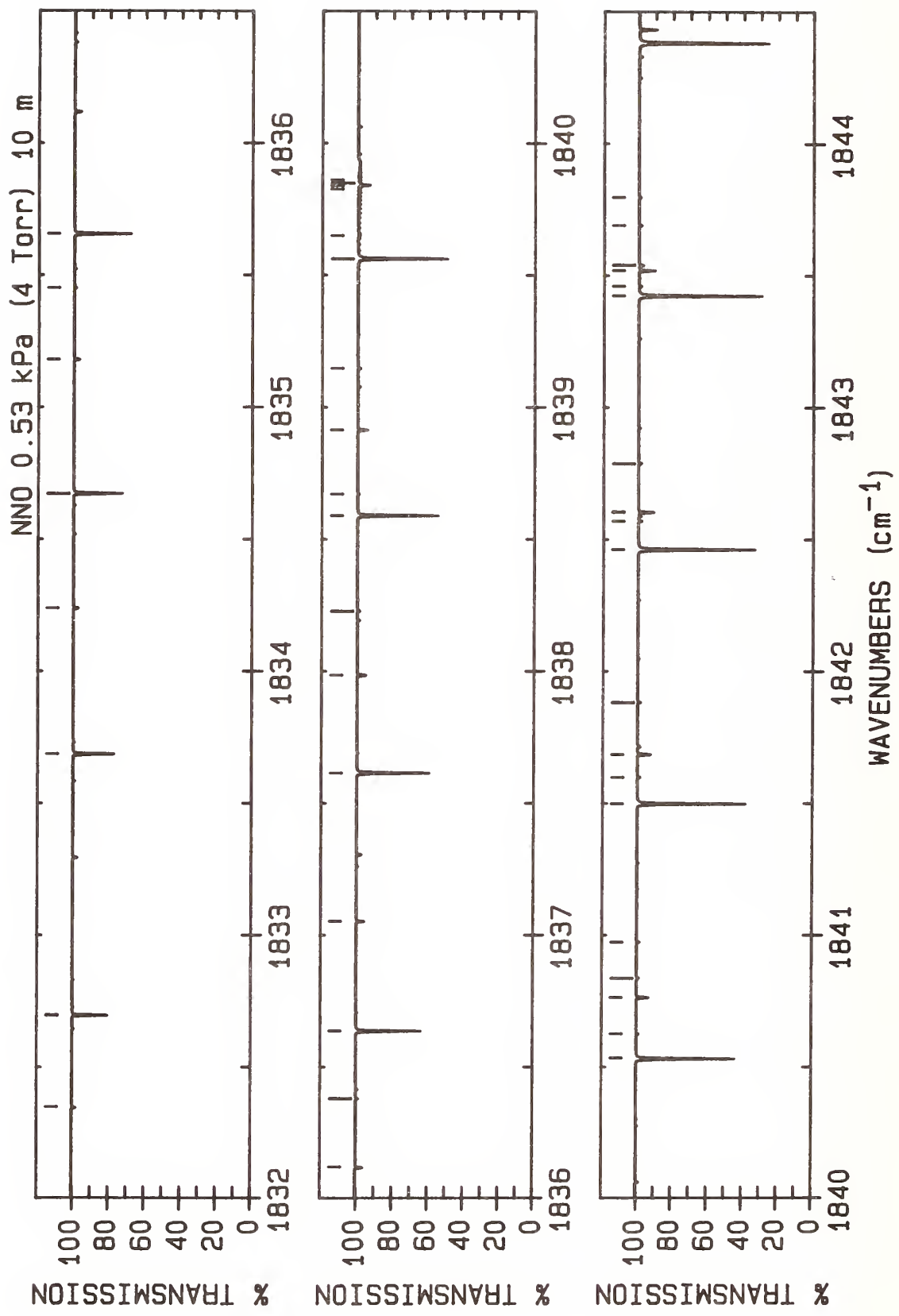

LINE #	WAVENUMBER(unc) (cm ⁻¹)	LOWER STATE (cm ⁻¹)	INTENSITY (cm/molecule)	ASSIGNMENT ROTATION BAND	LINE #	WAVENUMBER(unc) (cm ⁻¹)	LOWER STATE (cm ⁻¹)	INTENSITY (cm/molecule)	ASSIGNMENT ROTATION BAND
1	1832.346 99(32)	1494.20	0.102E-23	P(46) H	26	1839.860 5	83.06	0.753E-24	Q(14) T
2	1832.697 78(9)*	1153.46	0.929E-23	P(52) A	27	1840.532 35(8)*	828.95	0.340E-22	P(44) A
3	1833.687 01(9)*	1109.98	0.111E-22	P(51) A	28	1840.626 05(31)	1658.53	0.720E-24	P(50) C
4	1834.238 66(27)	1418.04	0.135E-23	P(44) H	29	1840.764 95(17)	1177.78	0.315E-23	P(37) H
5	1834.673 42(9)*	1067.33	0.132E-22	P(50) A	30	1840.838 5	284.13	0.748E-24	P(26) R
6	1835.179 88(25)	1381.21	0.154E-23	P(43) H	31	1840.974 4	211.96	0.858E-24	P(22) P
7	1835.452 1	340.10	0.653E-24	P(28) P	32	1841.498 85(8)*	792.14	0.392E-22	P(43) A
8	1835.657 00(8)*	1025.52	0.157E-22	P(49) A	33	1841.599 51(28)	1616.62	0.852E-24	P(49) C
9	1836.118 07(24)	1345.22	0.176E-23	P(42) H	34	1841.685 77(16)	1146.80	0.349E-23	P(36) H
10	1836.380 8	316.65	0.693E-24	P(27) P	35	1841.883 2	193.53	0.879E-24	P(21) P
11	1836.637 76(8)*	984.54	0.185E-22	P(48) A	36	1842.462 48(7)*	756.16	0.449E-22	P(42) A
12	1837.053 27(22)	1310.06	0.199E-23	P(41) H	37	1842.570 44(27)	1575.55	0.100E-23	P(48) C
13	1837.615 68(8)*	944.39	0.217E-22	P(47) A	38	1842.603 82(16)	1116.65	0.384E-23	P(35) H
14	1837.985 52(20)	1275.74	0.225E-23	P(40) H	39	1842.606 0	1568.31	0.315E-24	P(30) J
15	1838.228 2	272.26	0.769E-24	P(25) P	40	1842.788 6	175.94	0.894E-24	P(20) P
16	1838.590 76(8)*	905.08	0.253E-22	P(46) A	41	1843.423 23(7)*	721.01	0.513E-22	P(41) A
17	1838.671 58(38)	1744.84	0.507E-24	P(52) C	42	1843.460 5	223.43	0.842E-24	P(23) R
18	1838.914 86(19)	1242.25	0.253E-23	P(39) H	43	1843.519 15(15)	1087.34	0.421E-23	P(34) H
19	1839.146 9	251.32	0.802E-24	P(24) P	44	1843.538 82(25)	1535.31	0.118E-23	P(47) C
20	1839.562 98(8)*	866.60	0.294E-22	P(45) A	45	1843.540 9	2037.90	0.176E-24	P(42) D
21	1839.650 07(34)	1701.27	0.605E-24	P(51) C	46	1843.690 7	159.19	0.903E-24	P(19) P
22	1839.825 7	121.03	0.756E-24	Q(17) T	47	1843.796 50(27)	1614.68	0.622E-24	P(49) B
23	1839.838 1	107.58	0.760E-24	Q(16) T					
24	1839.841 32(18)	1209.60	0.283E-23	P(38) H					
25	1839.849 7	94.93	0.760E-24	Q(15) T					

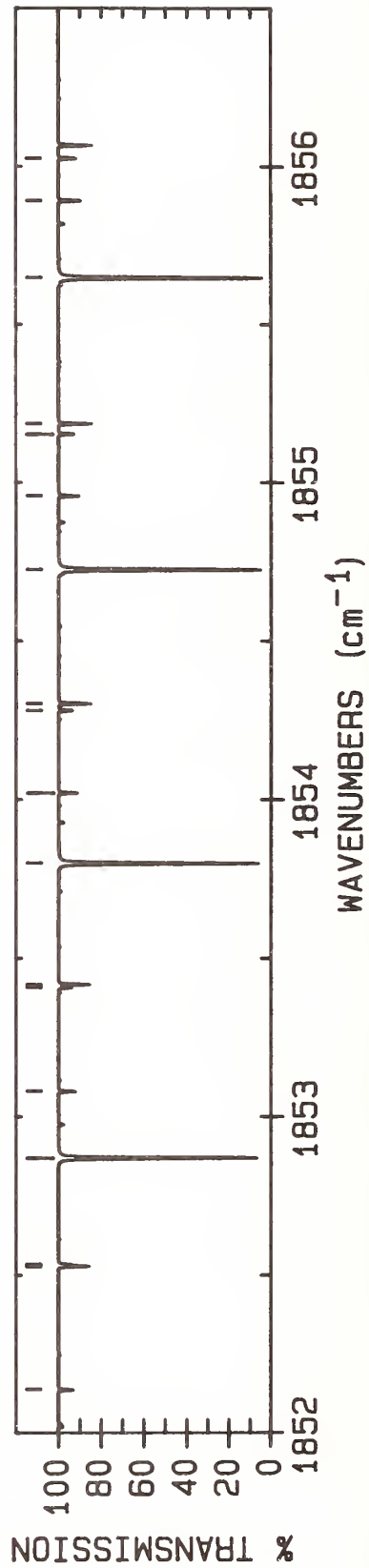
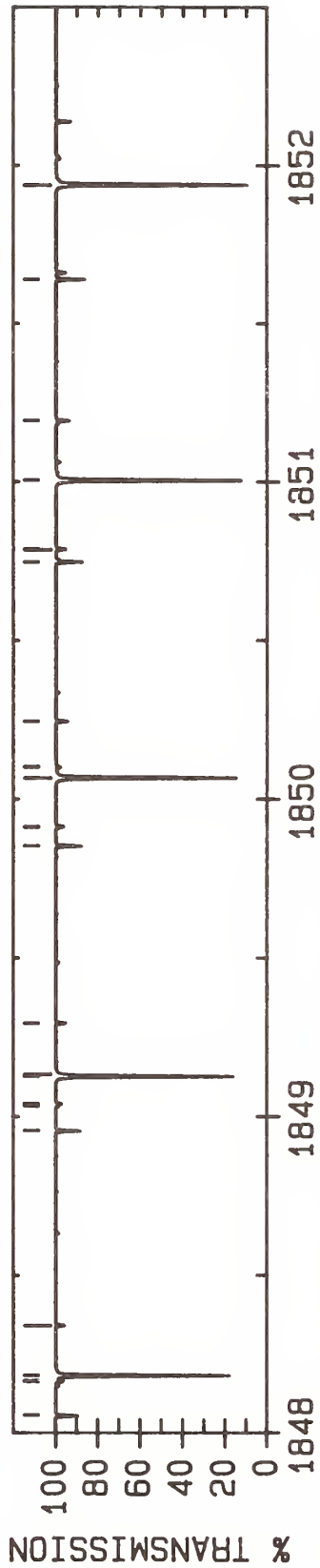
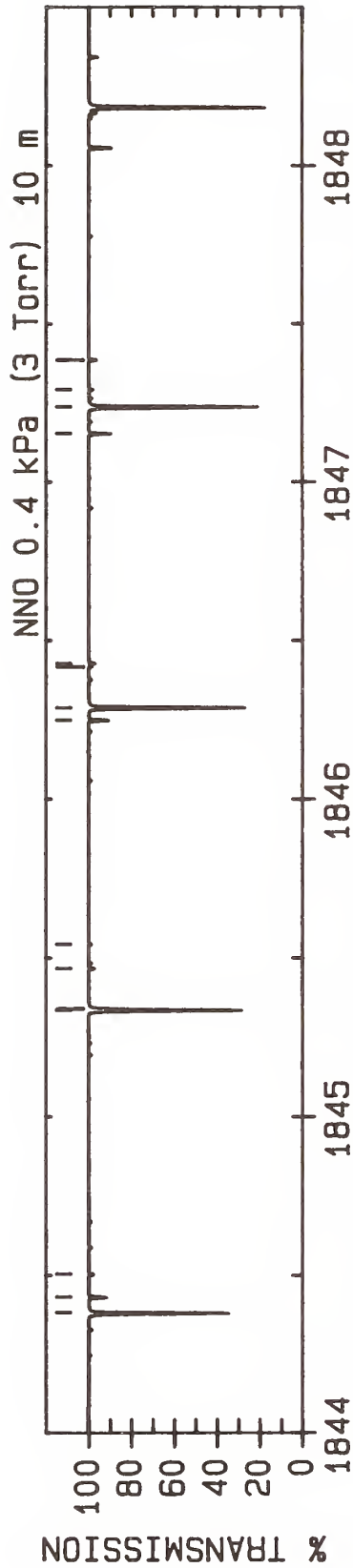

LINE #	WAVENUMBER(cm ⁻¹)	LOWER STATE (cm ⁻¹)	INTENSITY (cm/molecule)	ASSIGNMENT ROTATION BAND	LINE #	WAVENUMBER(unc)(cm ⁻¹)	LOWER STATE (cm ⁻¹)	INTENSITY (cm/molecule)	ASSIGNMENT ROTATION BAND
1	1844.381 10(7)*	686.70	0.582E-22	P(40) A	31	1850.100 3	1584.45	0.108E-23	P(31) G
2	1844.431 79(15)	1058.86	0.460E-23	P(33) H	32	1850.102 6	1810.37	0.399E-24	P(35) D
3	1844.504 65(24)	1495.90	0.137E-23	P(46) C	33	1850.245 54(23)	1277.04	0.315E-23	P(40) C
4	1845.336 08(7)*	653.23	0.658E-22	P(39) A	34	1850.747 85(15)	882.94	0.737E-23	P(26) H
5	1845.341 77(15)	1031.22	0.500E-23	P(32) H	35	1850.786 8	55.30	0.720E-24	P(11) P
6	1845.467 93(24)	1457.34	0.160E-23	P(45) C	36	1850.788 56(28)	1310.06	0.223E-23	P(41) B
7	1845.544 63(27)	1533.53	0.881E-24	P(47) B	37	1851.004 87(7)*	469.91	0.123E-21	P(33) A
8	1846.249 14(15)	1004.42	0.540E-23	P(31) H	38	1851.193 25(23)	1243.48	0.356E-23	P(39) C
9	1846.288 15(7)*	620.59	0.740E-22	P(38) A	39	1851.640 20(15)	861.16	0.772E-23	P(25) H
10	1846.418 76(27)	1494.20	0.104E-23	P(46) B	40	1851.939 44(7)*	442.28	0.135E-21	P(32) A
11	1846.428 63(24)	1419.61	0.185E-23	P(44) C	41	1852.138 33(23)	1210.77	0.400E-23	P(38) C
12	1847.153 91(15)	978.45	0.581E-23	P(30) H	42	1852.527 2	37.71	0.604E-24	P(9) P
13	1847.237 33(7)*	588.78	0.828E-22	P(37) A	43	1852.530 16(15)	840.21	0.805E-23	P(24) H
14	1847.292 88(28)	1455.70	0.122E-23	P(45) B	44	1852.535 37(27)	1242.25	0.291E-23	P(39) B
15	1847.386 75(23)	1382.71	0.213E-23	P(43) C	45	1852.871 07(7)*	415.49	0.146E-21	P(31) A
16	1848.056 14(15)	953.32	0.621E-23	P(29) H	46	1853.080 78(23)	1178.89	0.447E-23	P(37) C
17	1848.164 2	1638.97	0.916E-24	P(33) G	47	1853.408 38(26)	1209.60	0.330E-23	P(38) B
18	1848.166 96(28)	1418.04	0.143E-23	P(44) B	48	1853.417 76(15)	820.10	0.833E-23	P(23) H
19	1848.183 59(7)*	557.81	0.922E-22	P(36) A	49	1853.799 75(7)*	389.53	0.158E-21	P(30) A
20	1848.342 28(23)	1346.65	0.244E-23	P(42) C	50	1854.020 59(23)	1147.85	0.497E-23	P(36) C
21	1848.955 85(15)	929.02	0.661E-23	P(28) H	51	1854.281 07(25)	1177.78	0.373E-23	P(37) B
22	1849.032 9	76.25	0.810E-24	P(13) P	52	1854.303 02(15)	800.83	0.858E-23	P(22) H
23	1849.040 96(29)	1381.21	0.167E-23	P(43) B	53	1854.725 48(7)*	364.41	0.170E-21	P(29) A
24	1849.126 94(7)*	527.67	0.102E-21	P(35) A	54	1854.957 75(22)	1117.64	0.549E-23	P(35) C
25	1849.134 1	1611.29	0.995E-24	P(32) G	55	1855.153 41(24)	1146.80	0.419E-23	P(36) B
26	1849.295 21(23)	1311.42	0.278E-23	P(41) C	56	1855.185 97(15)	782.39	0.879E-23	P(21) H
27	1849.853 08(15)	905.56	0.700E-23	P(27) H	57	1855.648 26(7)*	340.12	0.181E-21	P(28) A
28	1849.911 5	65.36	0.768E-24	P(12) P	58	1855.892 25(22)	1088.28	0.605E-23	P(34) C
29	1849.914 84(29)	1345.22	0.193E-23	P(42) B	59	1856.025 36(23)	1116.65	0.468E-23	P(35) B
30	1850.067 37(7)*	498.37	0.112E-21	P(34) A					

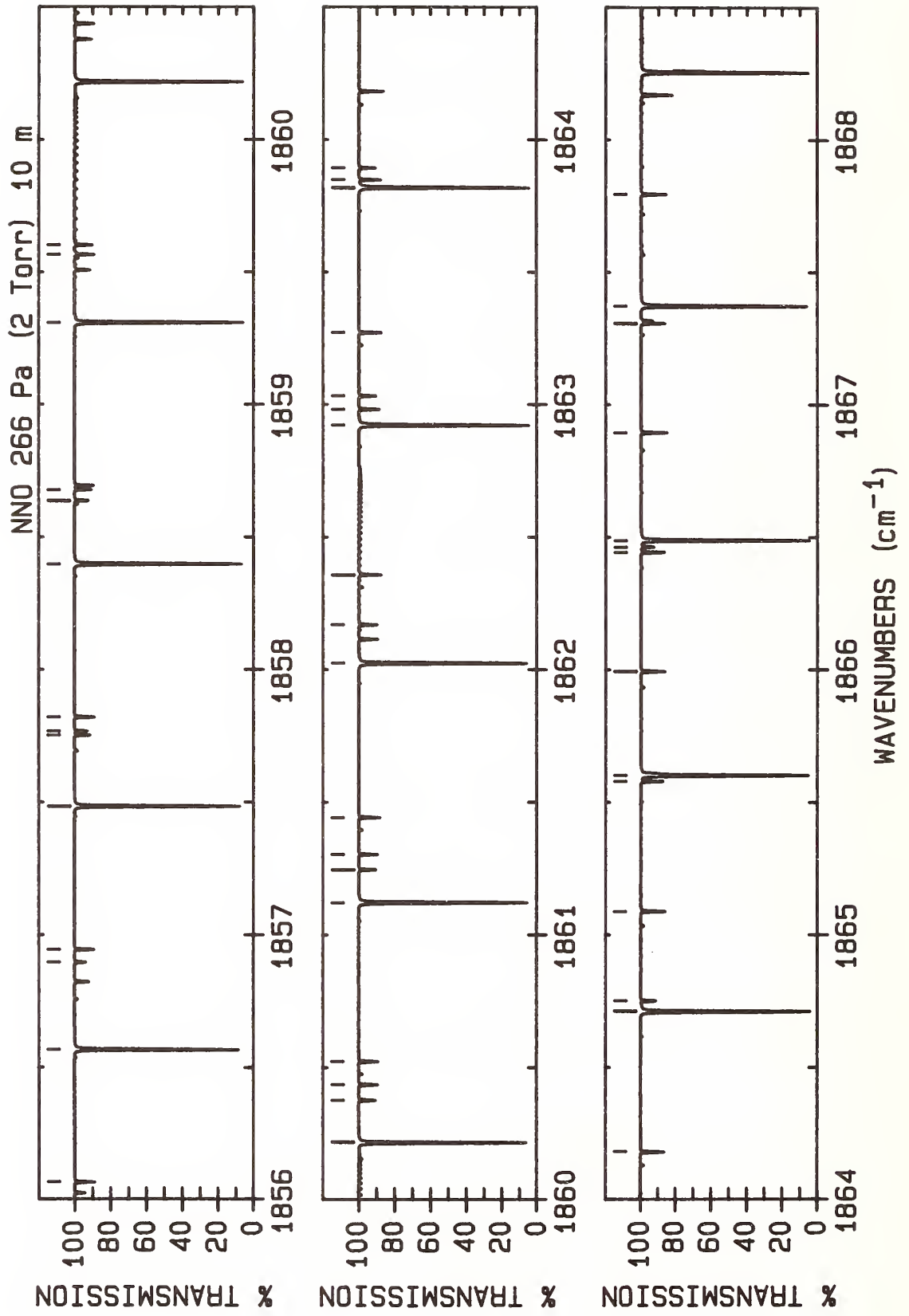

LINE #	WAVENUMBER(cm^{-1})	LOWER STATE (cm^{-1})	INTENSITY (cm^2/mole)	ASSIGNMENT ROTATION BAND	LINE #	WAVENUMBER(cm^{-1})	LOWER STATE (cm^{-1})	INTENSITY (cm^2/mole)	ASSIGNMENT ROTATION BAND
1	1856.066 64(14)	764.79	0.894E-23	P(20) H	26	1862.923 47(7)*	175.95	0.248E-21	P(20) A
2	1856.568 08(7)*	316.67	0.192E-21	P(27) A	27	1862.982 10(15)	905.56	0.925E-23	P(27) B
3	1856.896 87(22)	1087.34	0.520E-23	P(34) B	28	1863.032 49(13)	654.15	0.799E-23	P(12) H
4	1856.945 05(14)	748.03	0.904E-23	P(19) H	29	1863.271 52(15)	883.50	0.107E-22	P(26) C
5	1857.484 93(7)*	294.06	0.203E-21	P(26) A	30	1863.819 41(7)*	159.20	0.250E-21	P(19) A
6	1857.753 23(20)	1032.06	0.721E-23	P(32) C	31	1863.848 77(14)	882.94	0.981E-23	P(26) B
7	1857.767 91(21)	1058.86	0.574E-23	P(33) B	32	1863.893 56(13)	644.10	0.758E-23	P(11) H
8	1857.821 23(14)	732.11	0.908E-23	P(18) H	33	1864.181 72(15)	861.67	0.112E-22	P(25) C
9	1858.398 81(7)*	272.28	0.213E-21	P(25) A	34	1864.712 35(7)*	143.28	0.251E-21	P(18) A
10	1858.638 44(20)	1031.22	0.631E-23	P(32) B	35	1864.714 68(13)	861.16	0.103E-22	P(25) B
11	1858.679 70(19)	1005.20	0.782E-23	P(31) C	36	1864.752 54(13)	634.88	0.712E-23	P(10) H
12	1859.309 72(7)*	251.34	0.222E-21	P(24) A	37	1865.089 19(14)	840.68	0.117E-22	P(24) C
13	1859.566 96(13)	702.77	0.898E-23	P(16) H	38	1865.579 78(13)	840.21	0.108E-22	P(24) B
14	1859.603 48(19)	979.18	0.842E-23	P(30) C	39	1865.602 27(7)*	128.20	0.250E-21	P(17) A
15	1860.217 64(7)*	231.24	0.231E-21	P(23) A	40	1865.993 92(13)	820.54	0.121E-22	P(23) C
16	1860.377 81(17)	978.45	0.748E-23	P(30) B	41	1866.444 05(13)	820.10	0.112E-22	P(23) B
17	1860.436 56(13)	689.36	0.883E-23	P(15) H	42	1866.464 23(14)	618.95	0.603E-23	P(8) H
18	1860.524 55(18)	954.01	0.902E-23	P(29) C	43	1866.489 18(7)*	113.96	0.247E-21	P(16) A
19	1861.122 58(7)*	211.97	0.238E-21	P(22) A	44	1866.895 89(13)	801.23	0.124E-22	P(22) C
20	1861.246 58(16)	953.32	0.808E-23	P(29) B	45	1867.307 46(12)	800.83	0.116E-22	P(22) B
21	1861.304 00(13)	676.79	0.862E-23	P(14) H	46	1867.373 07(7)*	100.55	0.241E-21	P(15) A
22	1861.442 93(17)	929.66	0.961E-23	P(28) C	47	1867.795 11(13)	782.76	0.126E-22	P(21) C
23	1862.024 52(7)*	193.54	0.244E-21	P(21) A					
24	1862.169 31(13)	665.05	0.833E-23	P(13) H					
25	1862.358 58(16)	906.16	0.102E-22	P(27) C					

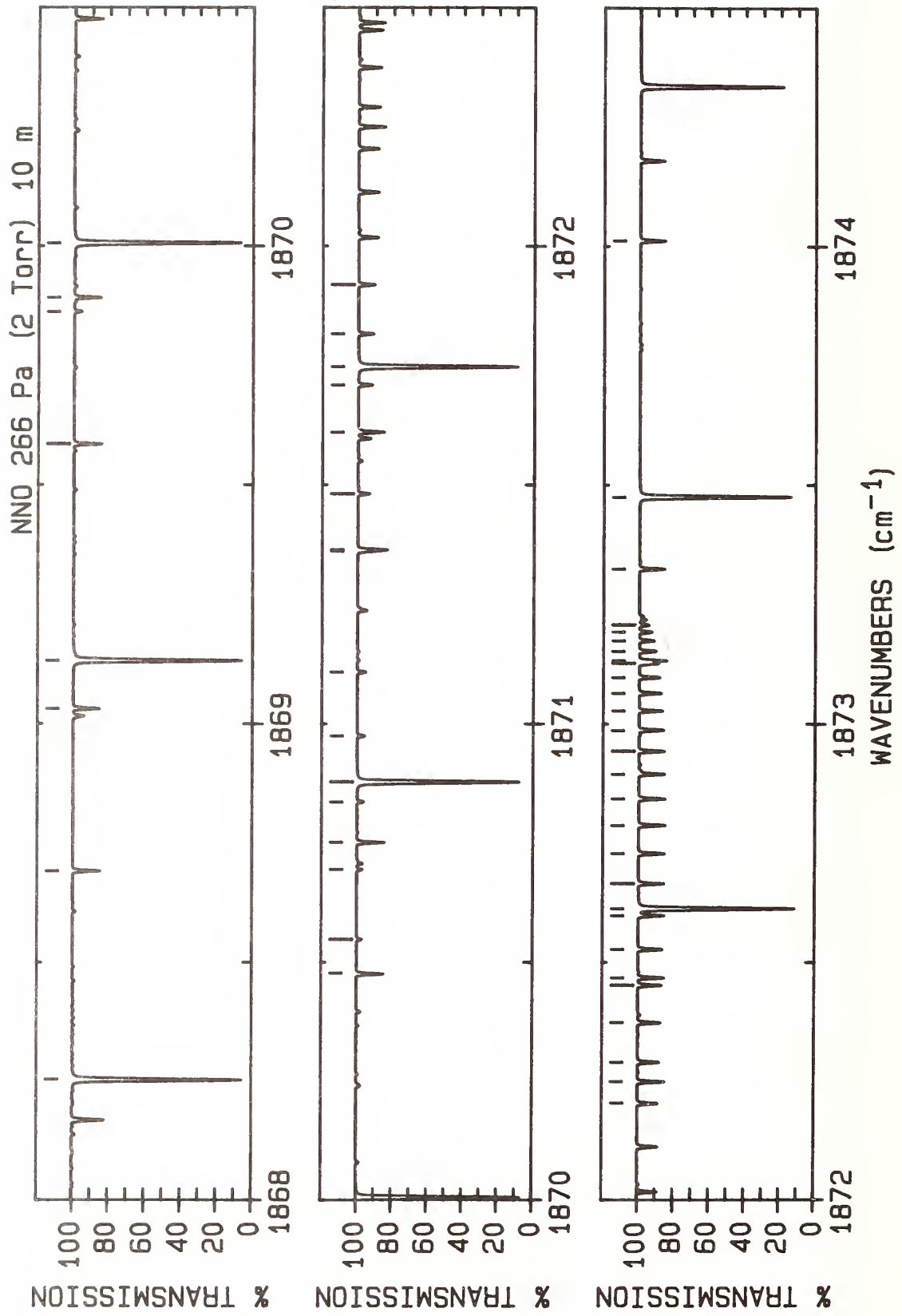

LINE #	WAVENUMBER(cm^{-1})	LOWER STATE (cm^{-1})	INTENSITY (cm^2/mole)	ASSIGNMENT ROTATION BAND	LINE #	WAVENUMBER(cm^{-1})	LOWER STATE (cm^{-1})	INTENSITY (cm^2/mole)	ASSIGNMENT ROTATION BAND
1	1868.253 93(7)*	87.98	0.234E-21	P(14) A	31	1872.467 96(14)	702.77	0.120E-22	P(16) B
2	1868.691 56(13)	765.12	0.128E-22	P(20) C	32	1872.527 23(14)	748.33	0.112E-22	Q(19) H
3	1869.031 53(13)	764.79	0.121E-22	P(20) B	33	1872.598 17(14)	732.38	0.116E-22	Q(18) H
4	1869.131 77(7)*	76.25	0.225E-21	P(13) A	34	1872.612 69(7)*	37.71	0.167E-21	P(9) A
5	1869.585 25(13)	748.33	0.128E-22	P(19) C	35	1872.665 21(14)	717.26	0.118E-22	Q(17) H
6	1869.862 85(15)	597.15	0.343E-23	P(4) H	36	1872.728 39(14)	702.99	0.120E-22	Q(16) H
7	1869.892 15(13)	748.03	0.122E-22	P(19) B	37	1872.787 71(13)	689.55	0.121E-22	Q(15) H
8	1870.006 56(7)*	65.36	0.213E-21	P(12) A	38	1872.843 21(13)	676.95	0.121E-22	Q(14) H
9	1870.476 15(13)	732.38	0.128E-22	P(18) C	39	1872.894 92(13)	665.20	0.120E-22	Q(13) H
10	1870.548 12(18)	1178.89	0.232E-23	Q(37) H	40	1872.942 84(13)	654.28	0.117E-22	Q(12) H
11	1870.694 80(17)	1147.85	0.266E-23	Q(36) H	41	1872.987 00(13)	644.20	0.114E-22	Q(11) H
12	1870.751 6	1349.99	0.824E-24	P(12) D	42	1873.027 42(13)	634.96	0.109E-22	Q(10) H
13	1870.751 77(13)	732.11	0.123E-22	P(18) B	43	1873.064 11(13)	626.56	0.103E-22	Q(9) H
14	1870.836 96(16)	1117.64	0.302E-23	Q(35) H	44	1873.097 09(14)	619.00	0.956E-23	Q(8) H
15	1870.878 32(7)*	55.31	0.200E-21	P(11) A	45	1873.126 37(14)	612.29	0.874E-23	Q(7) H
16	1870.974 62(16)	1088.28	0.342E-23	Q(34) H	46	1873.132 14(15)	689.55	0.120E-22	P(15) C
17	1871.107 84(15)	1059.75	0.385E-23	Q(33) H	47	1873.151 96(14)	606.41	0.781E-23	Q(6) H
18	1871.361 10(15)	1005.20	0.480E-23	Q(31) H	48	1873.173 88(14)	601.37	0.678E-23	Q(5) H
19	1871.364 27(14)	717.26	0.126E-22	P(17) C	49	1873.192 13(14)	597.17	0.567E-23	Q(4) H
20	1871.481 22(15)	979.18	0.532E-23	Q(30) H	50	1873.206 72(15)	593.81	0.449E-23	Q(3) H
21	1871.610 39(14)	717.02	0.122E-22	P(17) B	51	1873.324 46(15)	689.36	0.116E-22	P(15) B
22	1871.708 62(15)	929.66	0.642E-23	Q(28) H	52	1873.475 30(7)*	30.17	0.149E-21	P(8) A
23	1871.747 03(7)*	46.09	0.184E-21	P(10) A	53	1874.011 88(15)	676.95	0.115E-22	P(14) C
24	1871.815 97(15)	906.16	0.700E-23	Q(27) H					
25	1871.919 15(15)	883.50	0.758E-23	Q(26) H					
26	1872.203 96(15)	820.54	0.932E-23	Q(23) H					
27	1872.249 60(14)	702.99	0.124E-22	P(16) C					
28	1872.290 76(15)	801.23	0.986E-23	Q(22) H					
29	1872.373 56(15)	782.76	0.104E-22	Q(21) H					
30	1872.452 37(15)	765.12	0.108E-22	Q(20) H					

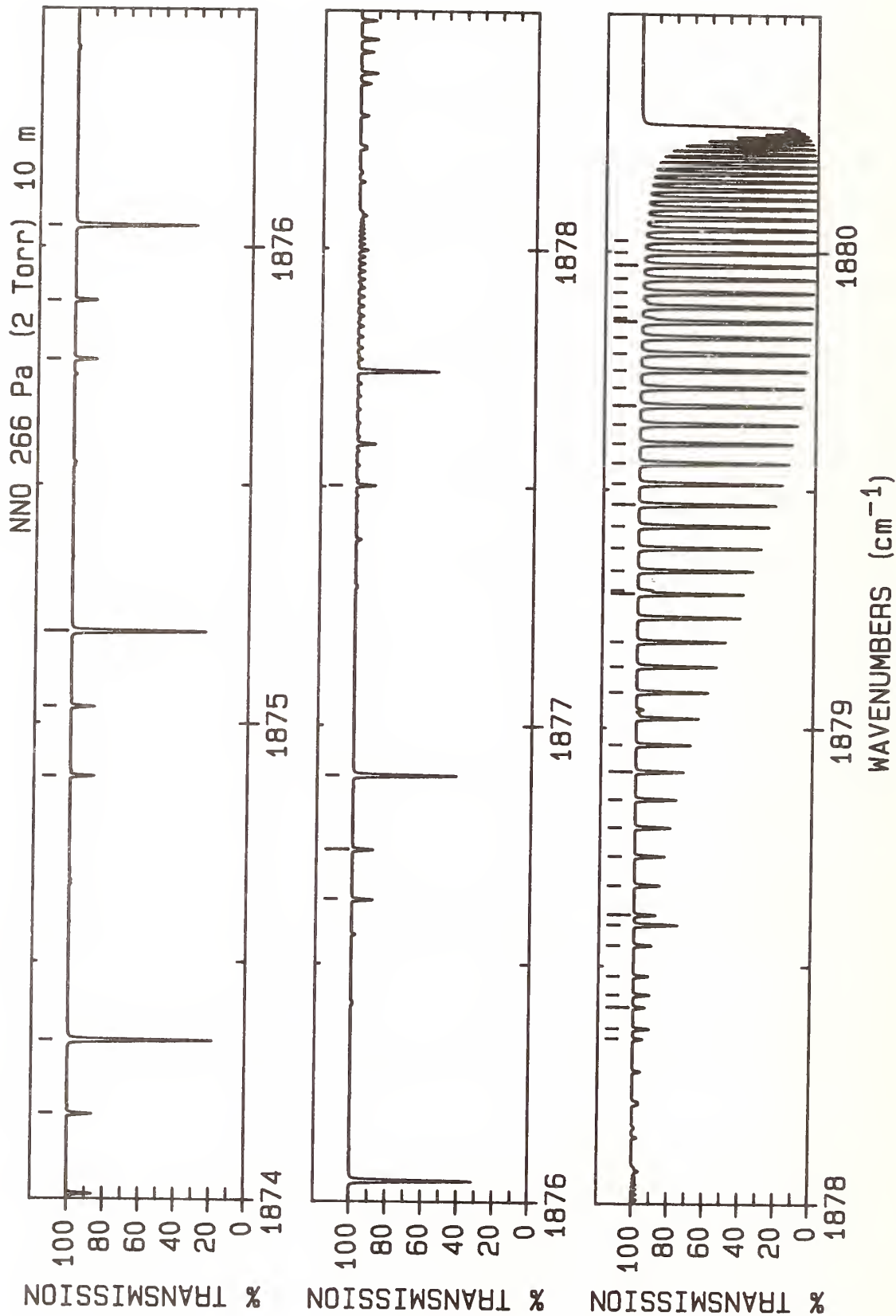

LINE #	WAVENUMBER(unc) (cm ⁻¹)	LOWER STATE (cm ⁻¹)	INTENSITY (cm/molecule)	ASSIGNMENT ROTATION BAND	LINE #	WAVENUMBER(unc) (cm ⁻¹)	LOWER STATE (cm ⁻¹)	INTENSITY (cm/molecule)	ASSIGNMENT ROTATION BAND
1	1874.179 88(16)	676.79	0.112E-22	P(14)	31	1879.288 30(19)	618.95	0.636E-23	P(8)
2	1874.334 85(7)*	23.46	0.129E-21	P(7)	32	1879.330 04(7)*	620.59	0.792E-22	Q(38)
3	1874.888 80(16)	665.20	0.109E-22	P(13)	33	1879.377 51(7)*	588.78	0.900E-22	Q(37)
4	1875.034 18(16)	665.05	0.106E-22	P(13)	34	1879.423 79(7)*	557.81	0.102E-21	Q(36)
5	1875.191 34(7)*	17.60	0.109E-21	P(6)	35	1879.468 87(7)*	527.67	0.115E-21	Q(35)
6	1875.762 91(17)	654.28	0.102E-22	P(12)	36	1879.512 74(7)*	498.37	0.128E-21	Q(34)
7	1875.887 35(17)	654.15	0.999E-23	P(12)	37	1879.555 41(7)*	469.91	0.143E-21	Q(33)
8	1876.044 76(7)*	12.57	0.875E-22	P(5)	38	1879.596 87(7)*	442.28	0.159E-21	Q(32)
9	1876.634 21(18)	644.20	0.937E-23	P(11)	39	1879.637 11(7)*	415.49	0.176E-21	Q(31)
10	1876.739 36(18)	644.10	0.922E-23	P(11)	40	1879.676 13(7)*	389.53	0.193E-21	Q(30)
11	1876.895 11(7)*	8.38	0.657E-22	P(4)	41	1879.713 93(7)*	364.41	0.211E-21	Q(29)
12	1877.502 68(18)	634.96	0.846E-23	P(10)	42	1879.750 50(7)*	340.12	0.229E-21	Q(28)
13	1878.346 70(10)*	1288.88	0.443E-23	Q(55)	43	1879.785 85(7)*	316.67	0.248E-21	Q(27)
14	1878.368 32(19)	626.56	0.748E-23	P(9)	44	1879.819 95(7)*	294.06	0.267E-21	Q(26)
15	1878.413 42(10)*	1242.91	0.544E-23	Q(54)	45	1879.852 82(7)*	272.28	0.285E-21	Q(25)
16	1878.439 85(19)	626.49	0.739E-23	P(9)	46	1879.860 59(14)	612.24	0.349E-23	R(7)
17	1878.479 08(10)*	1197.77	0.665E-23	Q(53)	47	1879.884 45(7)*	251.34	0.303E-21	Q(24)
18	1878.543 66(9)*	1153.46	0.810E-23	Q(52)	48	1879.914 83(7)*	231.24	0.321E-21	Q(23)
19	1878.586 58(7)*	2.51	0.216E-22	P(2)	49	1879.943 97(7)*	211.97	0.337E-21	Q(22)
20	1878.607 16(9)*	1109.98	0.981E-23	Q(51)	50	1879.971 86(7)*	193.54	0.353E-21	Q(21)
21	1878.669 56(9)*	1067.33	0.118E-22	Q(50)	51	1879.998 49(7)*	175.95	0.366E-21	Q(20)
22	1878.730 86(9)*	1025.52	0.142E-22	Q(49)	52	1880.023 88(7)*	159.20	0.378E-21	Q(19)
23	1878.791 04(8)*	984.54	0.170E-22	Q(48)					
24	1878.850 11(8)*	944.39	0.202E-22	Q(47)					
25	1878.908 04(8)*	905.08	0.240E-22	Q(46)					
26	1878.964 84(8)*	866.60	0.283E-22	Q(45)					
27	1879.075 00(8)*	792.14	0.389E-22	Q(43)					
28	1879.128 35(8)*	756.16	0.452E-22	Q(42)					
29	1879.180 53(8)*	721.01	0.524E-22	Q(41)					
30	1879.281 38(7)*	653.23	0.693E-22	Q(39)					

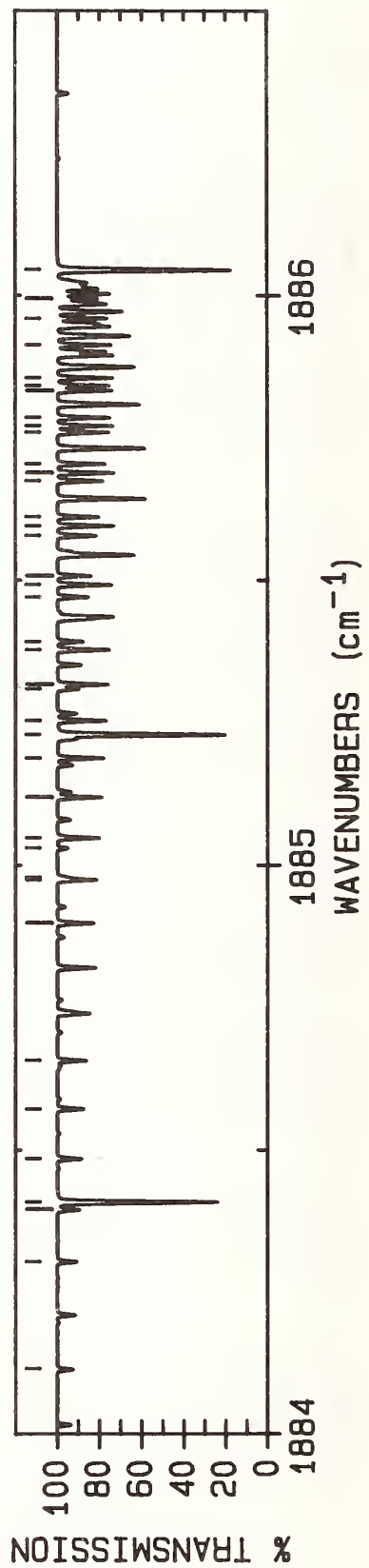
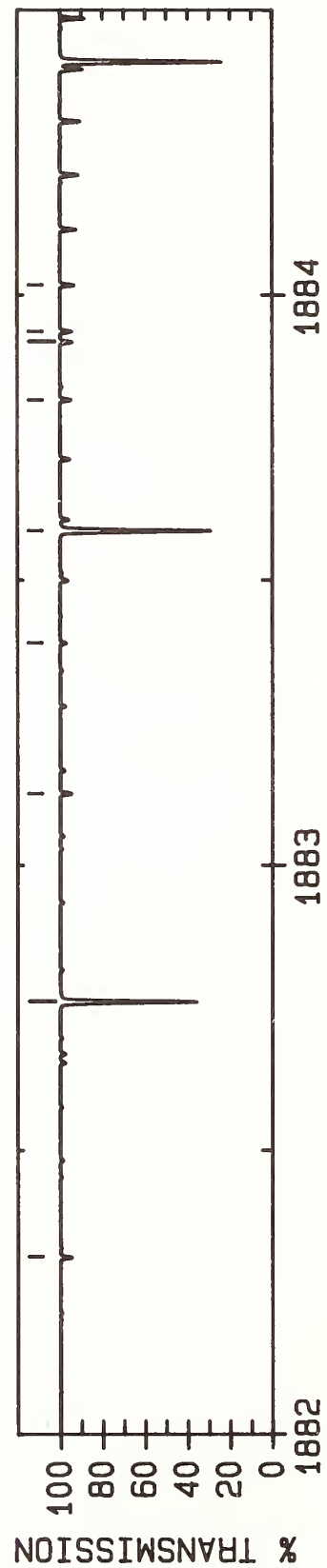
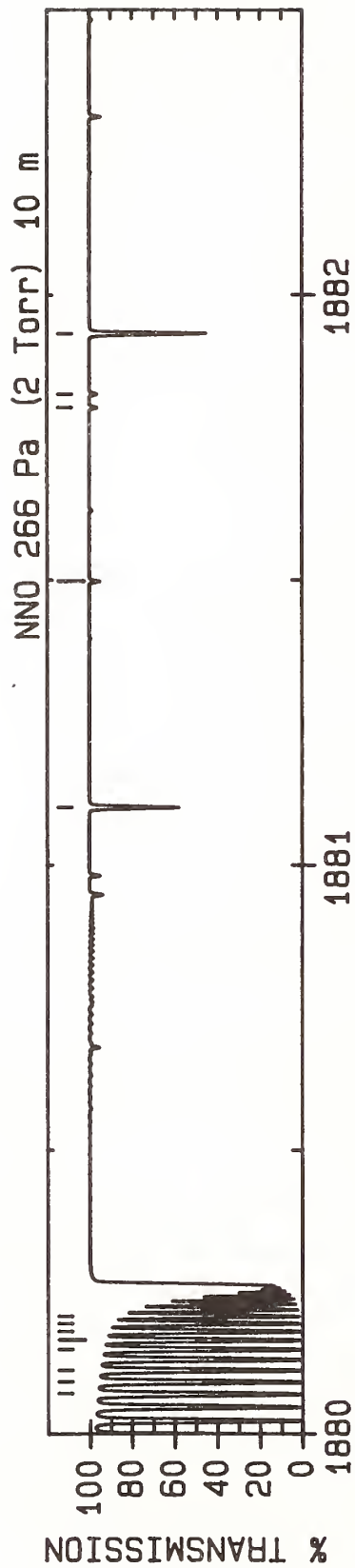

LINE #	WAVENUMBER(unc) (cm ⁻¹)	LOWER STATE (cm ⁻¹)	INTENSITY (cm/molecule)	ASSIGNMENT ROTATION BAND	LINE #	WAVENUMBER(unc) (cm ⁻¹)	LOWER STATE (cm ⁻¹)	INTENSITY (cm/molecule)	ASSIGNMENT ROTATION BAND
1	1880.070 87(7)*	128.20	0.394E-21	Q(17) A	36	1885.187 59(13)	840.68	0.186E-22	Q(24) C
2	1880.092 48(7)*	113.96	0.398E-21	Q(16) A	37	1885.228 75(7)*	12.57	0.122E-21	R(5) A
3	1880.112 83(7)*	100.55	0.399E-21	Q(15) A	38	1885.253 58(13)	820.54	0.196E-22	Q(23) C
4	1880.149 73(7)*	76.25	0.391E-21	Q(13) A	39	1885.309 37(22)	1058.86	0.821E-23	Q(33) B
5	1880.166 28(7)*	65.36	0.382E-21	Q(12) A	40	1885.317 06(13)	801.23	0.205E-22	Q(22) C
6	1880.181 57(7)*	55.31	0.369E-21	Q(11) A	41	1885.378 00(12)	782.76	0.213E-22	Q(21) C
7	1880.195 58(7)*	46.09	0.353E-21	Q(10) A	42	1885.392 47(20)	1004.42	0.100E-22	Q(31) B
8	1880.208 32(7)*	37.71	0.332E-21	Q(9) A	43	1885.470 58(19)	953.32	0.121E-22	Q(29) B
9	1881.100 64(7)*	0.00	0.411E-22	R(0) A	44	1885.492 13(13)	748.33	0.226E-22	Q(19) C
10	1881.497 37(13)	626.49	0.401E-23	R(9) H	45	1885.507 76(18)	929.02	0.131E-22	Q(28) B
11	1881.802 46(21)	601.37	0.302E-23	P(5) C	46	1885.578 33(16)	882.94	0.153E-22	Q(26) B
12	1881.826 24(21)	601.34	0.300E-23	P(5) B	47	1885.595 76(13)	717.26	0.233E-22	Q(17) C
13	1881.932 47(7)*	0.84	0.602E-22	R(1) A	48	1885.611 72(15)	861.16	0.163E-22	Q(25) B
14	1882.312 49(13)	634.88	0.419E-23	R(10) H	49	1885.674 71(14)	820.10	0.184E-22	Q(23) B
15	1882.761 20(7)*	2.51	0.779E-22	R(2) A	50	1885.688 71(14)	689.55	0.234E-22	Q(15) C
16	1883.125 40(13)	644.10	0.432E-23	R(11) H	51	1885.704 30(13)	800.83	0.193E-22	Q(22) B
17	1883.389 65(28)	1419.61	0.232E-23	Q(44) C	52	1885.759 67(13)	764.79	0.209E-22	Q(20) B
18	1883.586 83(7)*	5.03	0.941E-22	R(3) A	53	1885.770 79(16)	665.20	0.227E-22	Q(13) C
19	1883.815 79(28)	1277.04	0.411E-23	Q(40) C	54	1885.785 44(13)	748.03	0.216E-22	Q(19) B
20	1883.917 57(28)	1243.48	0.468E-23	Q(39) C	55	1885.833 14(13)	717.02	0.225E-22	Q(17) B
21	1883.936 09(13)	654.15	0.440E-23	R(12) H	56	1885.841 86(17)	644.20	0.212E-22	Q(11) C
22	1884.017 38(27)	1210.77	0.531E-23	Q(38) C	57	1885.855 08(14)	702.77	0.227E-22	Q(16) B
23	1884.115 18(26)	1178.89	0.600E-23	Q(37) C	58	1885.913 18(15)	665.05	0.222E-22	Q(13) B
24	1884.304 60(24)	1117.64	0.754E-23	Q(35) C	59	1885.959 70(18)	634.88	0.199E-22	Q(10) B
25	1884.396 16(23)	1088.28	0.839E-23	Q(34) C	60	1885.994 62(19)	612.24	0.156E-22	Q(7) B
26	1884.409 34(7)*	8.38	0.109E-21	R(4) A	61	1886.045 03(7)*	17.60	0.132E-21	R(6) A
27	1884.485 56(22)	1059.75	0.929E-23	Q(33) C					
28	1884.572 78(21)	1032.06	0.102E-22	Q(32) C					
29	1884.657 77(20)	1005.20	0.112E-22	Q(31) C					
30	1884.899 05(16)	929.66	0.144E-22	Q(28) C					
31	1884.974 81(16)	906.16	0.155E-22	Q(27) C					
32	1884.979 48(23)	1275.74	0.346E-23	Q(40) B					
33	1885.030 30(23)	1242.25	0.397E-23	Q(39) B					
34	1885.048 17(15)	883.50	0.166E-22	Q(26) C					
35	1885.119 10(14)	861.67	0.176E-22	Q(25) C					

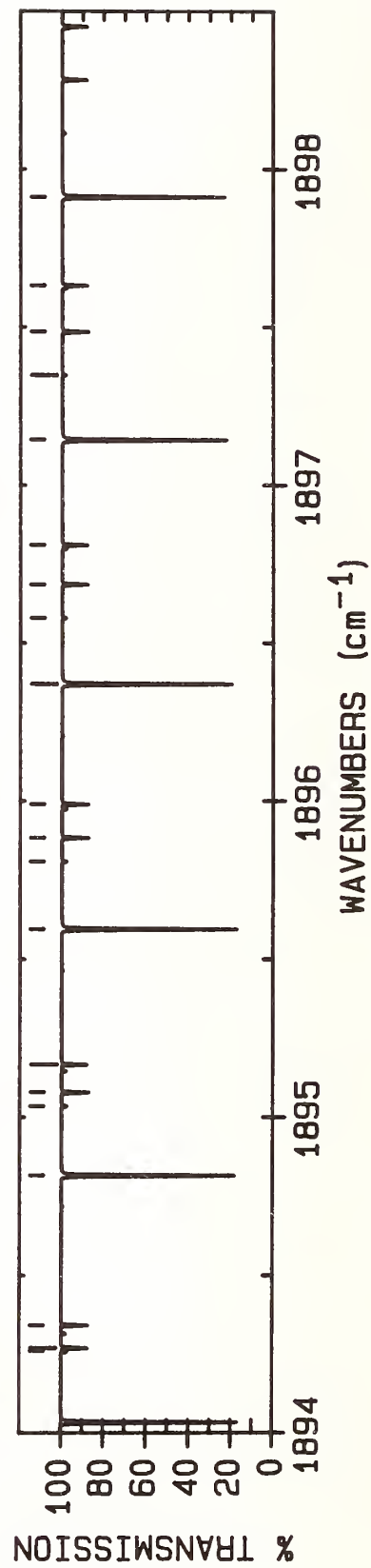
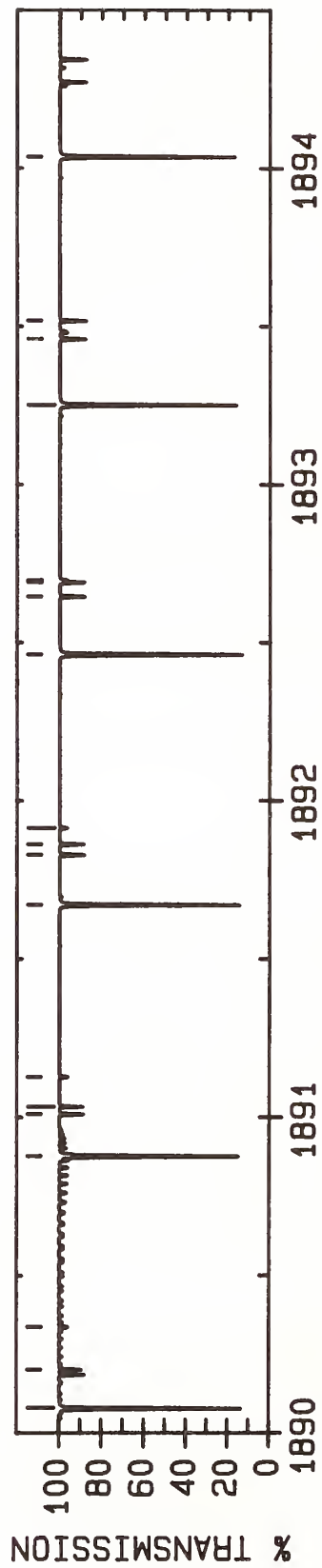
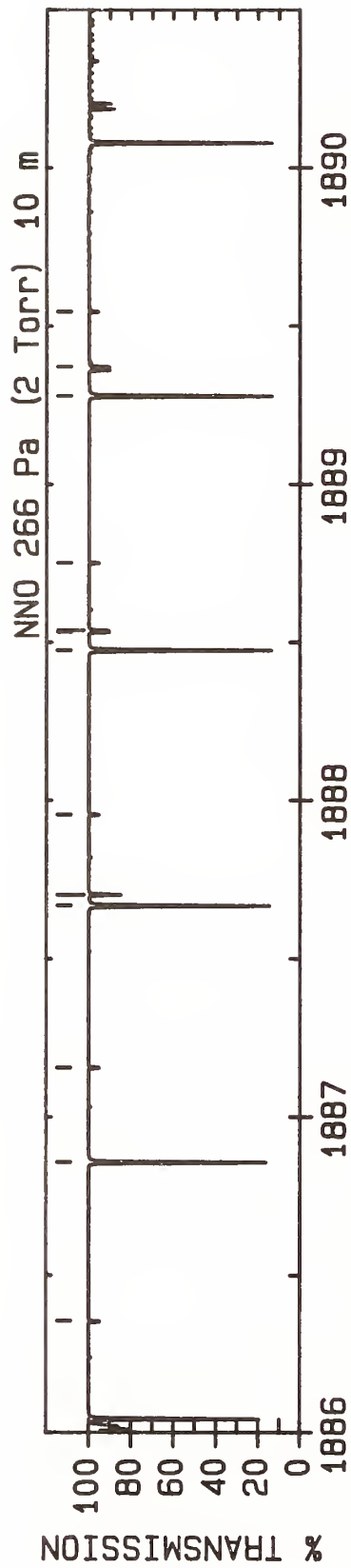

LINE #	WAVENUMBER(unc) (cm ⁻¹)	LOWER STATE (cm ⁻¹)	INTENSITY (cm/molecule)	ASSIGNMENT ROTATION BAND	LINE #	WAVENUMBER(unc) (cm ⁻¹)	LOWER STATE (cm ⁻¹)	INTENSITY (cm/molecule)	ASSIGNMENT ROTATION BAND
1	1886.354 51(14)	689.36	0.435E-23	R(15) H	31	1893.460 29(18)	619.00	0.104E-22	R(8) C
2	1886.858 19(7)*	23.46	0.141E-21	R(7) A	32	1893.517 73(18)	618.95	0.103E-22	R(8) B
3	1887.156 02(14)	702.77	0.425E-23	R(16) H	33	1894.035 55(7)*	113.96	0.147E-21	R(16) A
4	1887.668 23(7)*	30.17	0.149E-21	R(8) A	34	1894.259 36(15)	861.16	0.252E-23	R(25) H
5	1887.702 09(21)	589.61	0.691E-23	R(1) C	35	1894.271 27(18)	626.56	0.106E-22	R(9) C
6	1887.703 68(21)	589.61	0.691E-23	R(1) B	36	1894.343 17(18)	626.49	0.105E-22	R(9) B
7	1887.955 17(14)	717.02	0.413E-23	R(17) H	37	1894.817 28(7)*	128.20	0.141E-21	R(17) A
8	1888.475 14(7)*	37.71	0.154E-21	R(9) A	38	1895.035 72(15)	882.94	0.231E-23	R(26) H
9	1888.533 38(21)	591.29	0.745E-23	R(2) C	39	1895.079 34(17)	634.96	0.107E-22	R(10) C
10	1888.538 14(21)	591.28	0.745E-23	R(2) B	40	1895.167 35(17)	634.88	0.105E-22	R(10) B
11	1888.751 92(14)	732.11	0.398E-23	R(18) H	41	1895.595 86(7)*	143.28	0.134E-21	R(18) A
12	1889.278 91(7)*	46.09	0.158E-21	R(10) A	42	1895.809 36(15)	905.56	0.210E-23	R(27) H
13	1889.371 31(21)	593.80	0.809E-23	R(3) B	43	1895.884 48(16)	644.20	0.107E-22	R(11) C
14	1889.546 25(15)	748.03	0.380E-23	R(19) H	44	1895.990 28(16)	644.10	0.105E-22	R(11) B
15	1890.079 55(7)*	55.31	0.159E-21	R(11) A	45	1896.371 26(7)*	159.20	0.127E-21	R(19) A
16	1890.203 17(20)	597.15	0.871E-23	R(4) B	46	1896.580 25(15)	929.02	0.189E-23	R(28) H
17	1890.338 12(15)	764.79	0.361E-23	R(20) H	47	1896.686 71(15)	654.28	0.106E-22	R(12) C
18	1890.877 05(7)*	65.36	0.160E-21	R(12) A	48	1896.811 96(16)	654.15	0.104E-22	R(12) B
19	1891.009 90(20)	601.37	0.930E-23	R(5) C	49	1897.143 50(7)*	175.95	0.119E-21	R(20) A
20	1891.033 75(20)	601.34	0.926E-23	R(5) B	50	1897.348 32(15)	953.32	0.170E-23	R(29) H
21	1891.127 49(15)	782.39	0.340E-23	R(21) H	51	1897.486 01(15)	665.20	0.104E-22	R(13) C
22	1891.671 40(7)*	76.25	0.158E-21	R(13) A	52	1897.632 42(15)	665.05	0.101E-22	R(13) B
23	1891.829 60(19)	606.41	0.978E-23	R(6) C	53	1897.912 56(7)*	193.54	0.111E-21	R(21) A
24	1891.863 03(19)	606.37	0.972E-23	R(6) B					
25	1891.914 34(15)	800.83	0.319E-23	R(22) H					
26	1892.462 60(7)*	87.98	0.155E-21	R(14) A					
27	1892.646 40(19)	612.29	0.102E-22	R(7) C					
28	1892.691 02(19)	612.24	0.101E-22	R(7) B					
29	1892.698 63(15)	820.10	0.297E-23	R(23) H					
30	1893.250 65(7)*	100.55	0.151E-21	R(15) A					

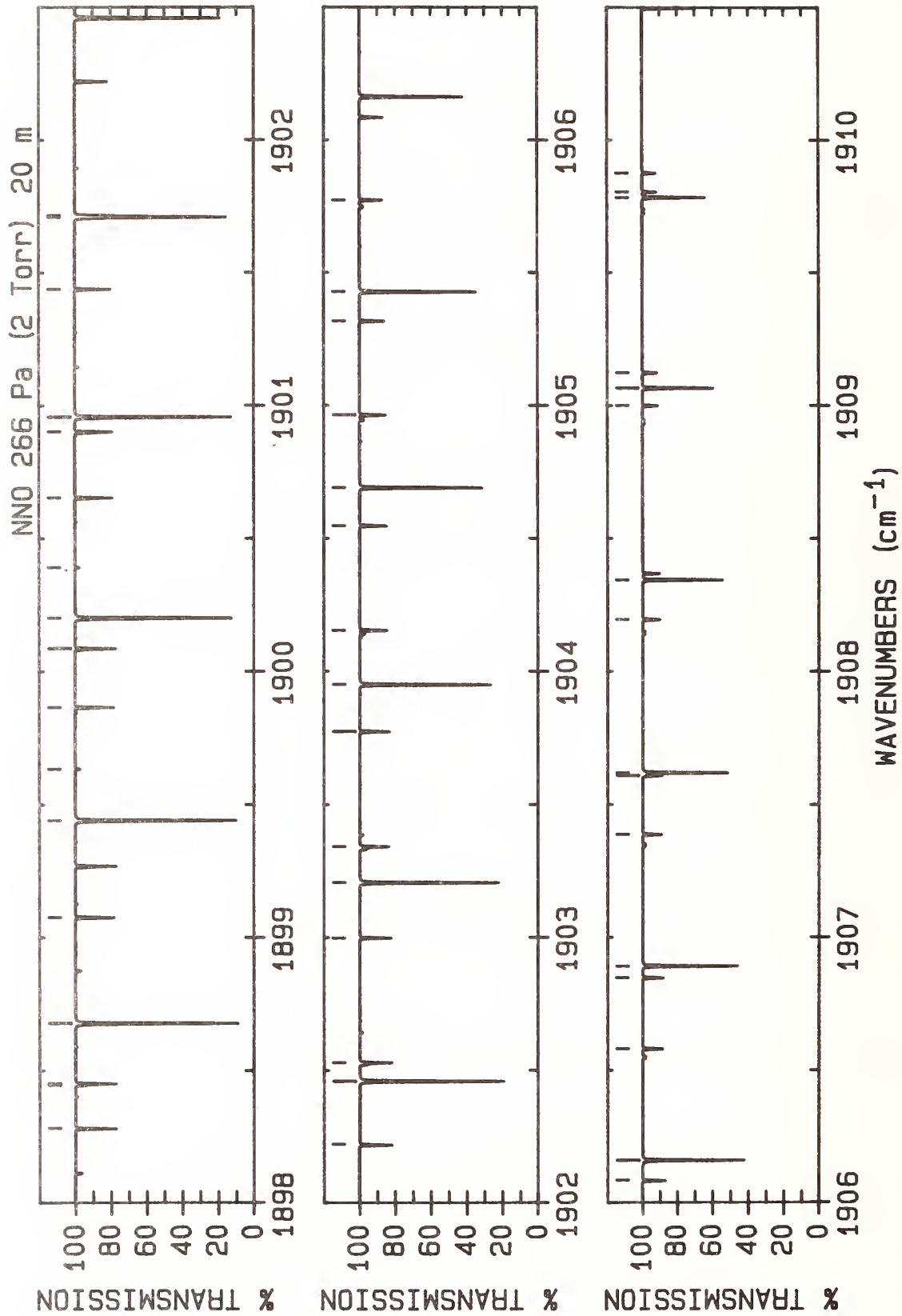

LINE #	WAVENUMBER(unc) (cm ⁻¹)	LOWER STATE (cm ⁻¹)	INTENSITY (cm/molecule)	ASSIGNMENT ROTATION BAND	LINE #	WAVENUMBER(unc) (cm ⁻¹)	LOWER STATE (cm ⁻¹)	INTENSITY (cm/molecule)	ASSIGNMENT ROTATION BAND
1	1898.282 38(14)	676.95	0.101E-22	R(14) C	26	1903.950 40(7)*	364.41	0.517E-22	R(29) A
2	1898.446 20(0)	1207.99	0.108E-23	R(8) E	27	1904.153 79(13)	782.39	0.656E-23	R(21) B
3	1898.446 51(0)	1207.99	0.108E-23	R(8) F	28	1904.547 72(14)	801.23	0.643E-23	R(22) C
4	1898.451 66(14)	676.79	0.984E-23	R(14) B	29	1904.690 75(7)*	389.53	0.458E-22	R(30) A
5	1898.678 44(7)*	211.97	0.103E-21	R(22) A	30	1904.963 97(13)	800.83	0.603E-23	R(22) B
6	1899.075 83(14)	689.55	0.978E-23	R(15) C	31	1905.317 65(15)	820.54	0.591E-23	R(23) C
7	1899.441 15(7)*	231.24	0.952E-22	R(23) A	32	1905.427 90(7)*	415.49	0.403E-22	R(31) A
8	1899.635 31(15)	1031.22	0.119E-23	R(32) H	33	1905.773 11(13)	820.10	0.551E-23	R(23) B
9	1899.866 34(13)	702.99	0.939E-23	R(16) C	34	1906.084 63(15)	840.68	0.540E-23	R(24) C
10	1900.086 56(13)	702.77	0.907E-23	R(16) B	35	1906.161 84(7)*	442.28	0.353E-22	R(32) A
11	1900.200 67(7)*	251.34	0.873E-22	R(24) A	36	1906.581 23(14)	840.21	0.500E-23	R(24) B
12	1900.391 74(16)	1058.86	0.105E-23	R(33) H	37	1906.848 66(16)	861.67	0.490E-23	R(25) C
13	1900.653 92(13)	717.26	0.896E-23	R(17) C	38	1906.892 57(7)*	469.91	0.308E-22	R(33) A
14	1900.902 26(13)	717.02	0.862E-23	R(17) B	39	1907.388 37(15)	861.16	0.452E-23	R(25) B
15	1900.957 00(7)*	272.28	0.795E-22	R(25) A	40	1907.609 75(17)	883.50	0.443E-23	R(26) C
16	1901.438 56(13)	732.38	0.849E-23	R(18) C	41	1907.620 08(7)*	498.37	0.266E-22	R(34) A
17	1901.710 14(7)*	294.06	0.720E-22	R(26) A	42	1908.194 55(16)	882.94	0.405E-23	R(26) B
18	1901.716 81(13)	732.11	0.813E-23	R(18) B	43	1908.344 38(7)*	527.67	0.229E-22	R(35) A
19	1902.220 26(13)	748.33	0.799E-23	R(19) C	44	1908.999 80(16)	905.56	0.361E-23	R(27) B
20	1902.460 09(7)*	316.67	0.649E-22	R(27) A	45	1909.065 46(7)*	557.81	0.197E-22	R(36) A
21	1902.530 24(12)	748.03	0.762E-23	R(19) B	46	1909.123 06(19)	929.66	0.355E-23	R(28) C
22	1902.999 02(13)	765.12	0.748E-23	R(20) C	47	1909.783 32(7)*	588.78	0.167E-22	R(37) A
23	1903.206 85(7)*	340.12	0.581E-22	R(28) A	48	1909.804 14(17)	929.02	0.320E-23	R(28) B
24	1903.342 55(12)	764.79	0.710E-23	R(20) B	49	1909.875 28(19)	954.01	0.316E-23	R(29) C
25	1903.774 84(13)	782.76	0.696E-23	R(21) C					

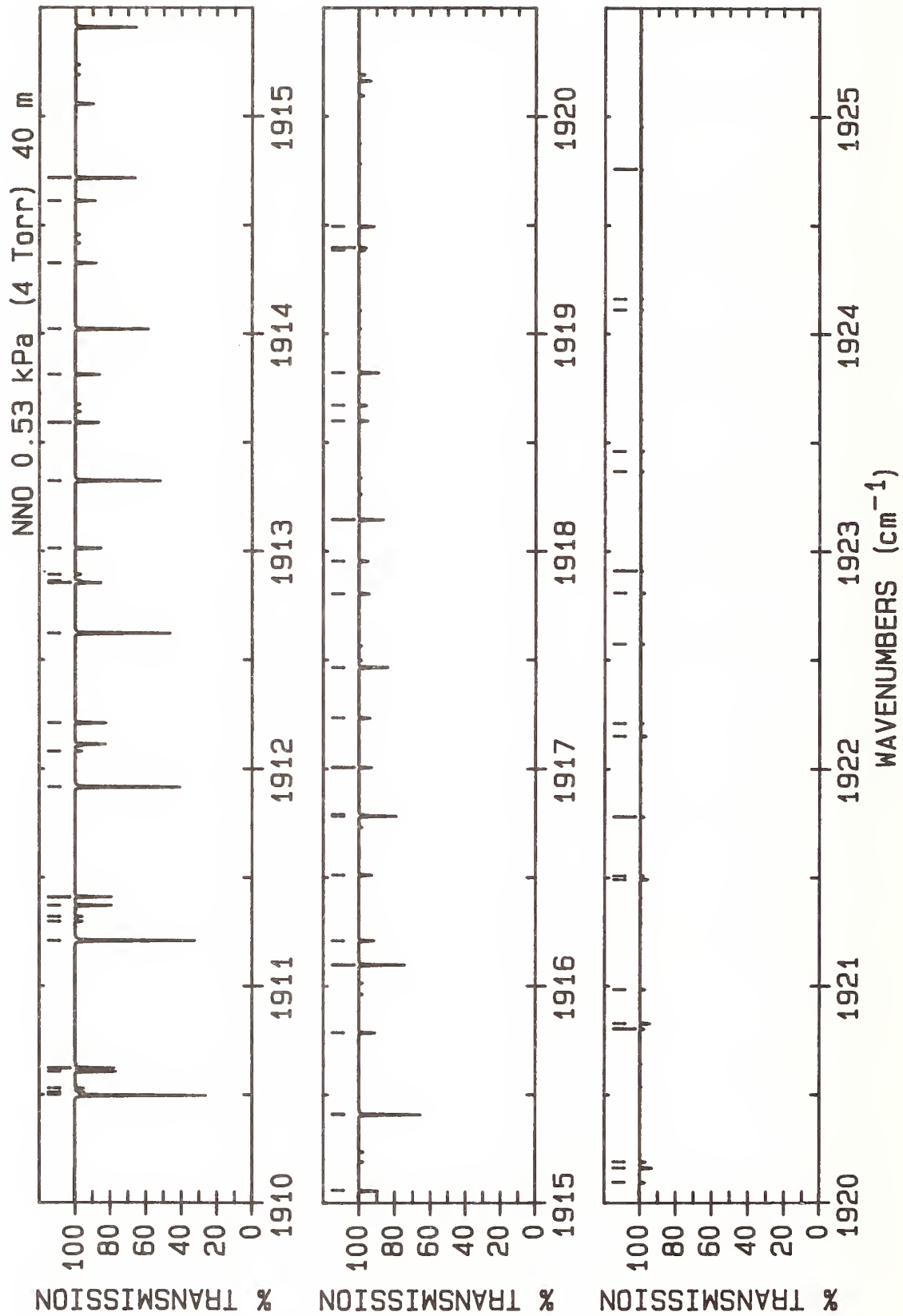

LINE #	WAVENUMBER(unc) (cm ⁻¹)	LOWER STATE (cm ⁻¹)	INTENSITY (cm/molecule)	ASSIGNMENT ROTATION BAND	LINE #	WAVENUMBER(unc) (cm ⁻¹)	LOWER STATE (cm ⁻¹)	INTENSITY (cm/molecule)	ASSIGNMENT ROTATION BAND
1	1910.497 96(7)*	620.59	0.142E-22	R(38)	36	1917.234 97(23)	1243.48	0.716E-24	R(39)
2	1910.511 9	1409.62	0.539E-24	R(23)	37	1917.466 62(9)*	984.54	0.202E-23	R(48)
3	1910.530 2	1409.60	0.539E-24	R(23)	38	1917.804 21(28)	1209.60	0.704E-24	R(38)
4	1910.607 61(19)	953.32	0.282E-23	R(29)	39	1917.954 67(23)	1277.04	0.600E-24	R(40)
5	1910.624 55(20)	979.18	0.279E-23	R(30)	40	1918.145 68(9)*	1025.52	0.162E-23	R(49)
6	1911.209 37(7)*	653.23	0.120E-22	R(39)	41	1918.600 54(28)	1242.25	0.586E-24	R(39)
7	1911.298 1	1429.78	0.490E-24	R(24)	42	1918.671 43(23)	1311.42	0.500E-24	R(41)
8	1911.319 7	1429.76	0.490E-24	R(24)	43	1918.821 50(9)*	1067.33	0.129E-23	R(50)
9	1911.370 87(21)	1005.20	0.245E-23	R(31)	44	1919.385 22(24)	1346.65	0.414E-24	R(42)
10	1911.410 22(20)	978.45	0.248E-23	R(30)	45	1919.396 34(29)	1275.74	0.486E-24	R(40)
11	1911.917 55(7)*	686.70	0.100E-22	R(40)	46	1919.494 07(9)*	1109.98	0.102E-23	R(51)
12	1912.081 9	1450.78	0.443E-24	R(25)	47	1920.096 06(24)	1382.71	0.341E-24	R(43)
13	1912.212 02(21)	1004.42	0.216E-23	R(31)	48	1920.163 41(10)*	1153.46	0.798E-24	R(52)
14	1912.622 50(8)*	721.01	0.837E-23	R(41)	49	1920.191 62(29)	1310.06	0.401E-24	R(41)
15	1912.854 64(22)	1059.75	0.186E-23	R(33)	50	1920.803 95(24)	1419.61	0.280E-24	R(44)
16	1912.863 2	1472.61	0.399E-24	R(26)	51	1920.829 50(10)*	1197.77	0.623E-24	R(53)
17	1912.892 7	1472.58	0.398E-24	R(26)	52	1920.986 41(28)	1345.22	0.328E-24	R(42)
18	1913.013 03(22)	1031.22	0.187E-23	R(32)	53	1921.492 34(10)*	1242.91	0.484E-24	R(54)
19	1913.324 23(8)*	756.16	0.695E-23	R(42)	54	1921.508 88(25)	1457.34	0.228E-24	R(45)
20	1913.592 08(23)	1088.28	0.161E-23	R(34)	55	1921.780 75(28)	1381.21	0.267E-24	R(43)
21	1913.813 28(23)	1058.86	0.161E-23	R(33)	56	1922.151 95(11)*	1288.88	0.374E-24	R(55)
22	1914.022 72(8)*	792.14	0.573E-23	R(43)	57	1922.210 86(26)	1495.90	0.185E-24	R(46)
23	1914.326 57(23)	1117.64	0.138E-23	R(35)	58	1922.574 67(27)	1418.04	0.217E-24	R(44)
24	1914.612 80(24)	1087.34	0.138E-23	R(34)	59	1922.808 31(11)*	1335.69	0.287E-24	R(56)
25	1914.717 97(8)*	828.95	0.471E-23	R(44)	60	1922.909 90(28)	1535.31	0.149E-24	R(47)
26	1915.058 11(23)	1147.85	0.118E-23	R(36)	61	1923.368 19(27)	1455.70	0.175E-24	R(45)
27	1915.409 99(8)*	866.60	0.384E-23	R(45)	62	1923.461 42(12)*	1383.33	0.219E-24	R(57)
28	1915.411 62(25)	1116.65	0.118E-23	R(35)	63	1924.111 29(12)*	1431.79	0.167E-24	R(58)
29	1915.786 69(23)	1178.89	0.101E-23	R(37)	64	1924.161 34(26)	1494.20	0.140E-24	R(46)
30	1916.098 77(8)*	905.08	0.312E-23	R(46)	65	1924.757 92(13)*	1481.09	0.126E-24	R(59)
31	1916.209 77(26)	1146.80	0.997E-24	R(36)					
32	1916.512 31(23)	1210.77	0.851E-24	R(38)					
33	1916.784 32(8)*	944.39	0.252E-23	R(47)					
34	1916.791 5	1594.33	0.215E-24	R(31)					
35	1917.007 29(27)	1177.78	0.840E-24	R(37)					

ATLAS OF N₂O ABSORPTION LINES FROM 2140 cm⁻¹ to 2269 cm⁻¹

key:

Band	Isotopomer	Vibrational Transition
A	¹⁴ N ¹⁴ N ¹⁶ O	10 ⁰ 0-00 ⁰ 0
B		11 ¹ 0-01 ^{1e} 0
C		11 ¹ 0-01 ^{1f} 0
D		10 ⁰ 1-00 ⁰ 1
E		12 ² 0-02 ^{2e} 0
F		12 ² 0-02 ^{2f} 0
G		12 ⁰ 0-02 ⁰ 0
H		11 ¹ 1-01 ^{1e} 1
I		11 ¹ 1-01 ^{1f} 1
J		13 ¹ 0-03 ^{1e} 0
K		13 ¹ 0-03 ^{1f} 0
L		13 ³ 0-03 ^{3e} 0
M		13 ³ 0-03 ^{3f} 0
P	¹⁴ N ¹⁵ N ¹⁶ O	10 ⁰ 0-00 ⁰ 0
N		11 ¹ 0-01 ^{1e} 0
O		11 ¹ 0-01 ^{1f} 0
R	¹⁵ N ¹⁴ N ¹⁶ O	10 ⁰ 0-00 ⁰ 0
S		11 ¹ 0-01 ^{1e} 0
W		11 ¹ 0-01 ^{1f} 0
T	¹⁴ N ¹⁴ N ¹⁸ O	10 ⁰ 0-00 ⁰ 0
Y		11 ¹ 0-01 ^{1e} 0
Z		11 ¹ 0-01 ^{1f} 0
V	¹⁴ N ¹⁴ N ¹⁷ O	10 ⁰ 0-00 ⁰ 0

If the e or f designation is not specified (for $l \neq 0$), then the transition is to either level, depending on the selection rules and the change in the rotational quantum number, J . Spectra are given for a slitwidth of 0.002 cm⁻¹ and a transition moment of 0.244 debye at a temperature of 296 K. The Herman-Wallis constants used in the calculations were $C_1 = -0.00012$ and $C_2 = -0.0000098$ as given by Boissy *et al.* [5.187].

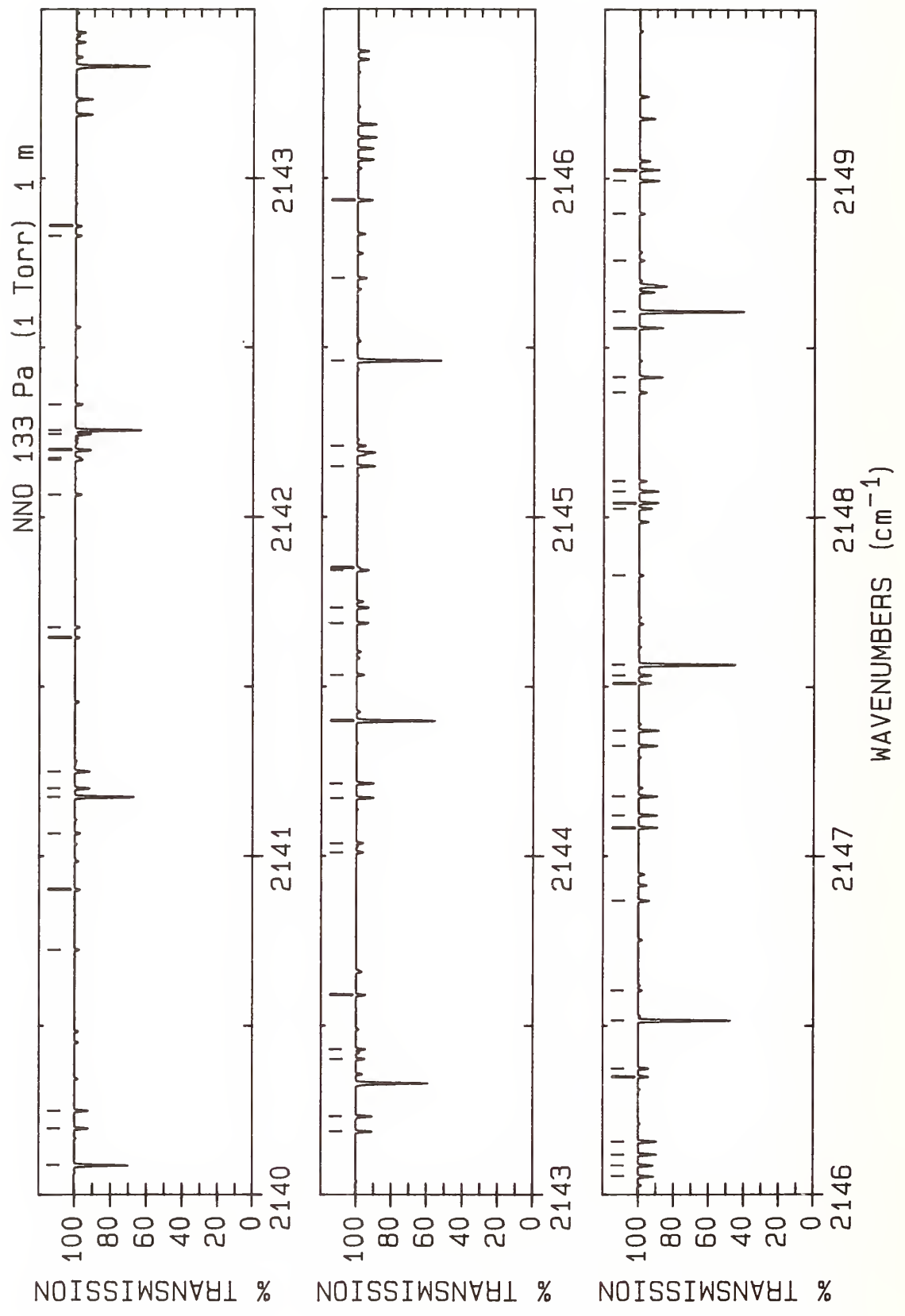

LINE #	WAVENUMBER(unc) (cm ⁻¹)	LOWER STATE (cm ⁻¹)	INTENSITY (cm/molecule)	ASSIGNMENT ROTATION BAND	LINE #	WAVENUMBER(unc) (cm ⁻¹)	LOWER STATE (cm ⁻¹)	INTENSITY (cm/molecule)	ASSIGNMENT ROTATION BAND
1	2140.087 86(3)	653.18	0.558E-21	P(39)	36	2145.149 3	769.40	0.172E-21	P(21)
2	2140.197 6	870.13	0.130E-21	P(26)	37	2145.209 6	2247.89	0.839E-22	P(50)
3	2140.249 8	869.56	0.131E-21	P(26)	38	2145.460 92(3)	498.34	0.104E-20	P(34)
4	2140.723 78(5)*	2446.02	0.471E-22	P(76)	39	2145.704 6	2237.36	0.885E-22	P(50)
5	2140.900 70(8)*	2387.14	0.545E-22	P(65)	40	2145.934 91(8)*	2174.53	0.145E-21	P(61)
6	2141.067 71(8)*	2383.76	0.554E-22	P(65)	41	2146.054 87(5)*	2197.45	0.151E-21	P(72)
7	2141.175 45(3)	620.54	0.638E-21	P(38)	42	2146.087 58(8)*	2171.55	0.147E-21	P(61)
8	2141.200 9	848.30	0.139E-21	P(25)	43	2146.120 1	751.77	0.179E-21	P(20)
9	2141.250 7	847.78	0.140E-21	P(25)	44	2146.158 5	751.43	0.179E-21	P(20)
10	2141.644 3	2379.09	0.468E-22	P(53)	45	2146.350 4	2206.29	0.101E-21	P(49)
11	2141.674 6	2378.66	0.469E-22	P(53)	46	2146.374 9	2205.96	0.101E-21	P(49)
12	2142.066 37(5)*	2382.64	0.634E-22	P(75)	47	2146.516 04(3)	469.88	0.116E-20	P(33)
13	2142.169 07(8)*	2332.74	0.700E-22	P(64)	48	2146.604 30(28)	2340.67	0.401E-22	P(37)
14	2142.174 7	2367.97	0.495E-22	P(53)	49	2146.868 3	2195.49	0.106E-21	P(49)
15	2142.197 7	827.32	0.148E-21	P(24)	50	2147.084 5	734.98	0.185E-21	P(19)
16	2142.245 2	826.83	0.149E-21	P(24)	51	2147.120 6	734.67	0.185E-21	P(19)
17	2142.256 55(3)	588.74	0.726E-21	P(37)	52	2147.177 09(8)*	2123.45	0.183E-21	P(60)
18	2142.332 43(8)*	2329.46	0.712E-22	P(64)	53	2147.326 27(8)*	2120.57	0.185E-21	P(60)
19	2142.830 6	2334.64	0.571E-22	P(52)	54	2147.371 27(5)*	2137.38	0.199E-21	P(71)
20	2142.859 4	2334.23	0.572E-22	P(52)	55	2147.510 5	2165.18	0.121E-21	P(48)
21	2143.188 1	807.17	0.157E-21	P(23)	56	2147.533 7	2164.88	0.121E-21	P(48)
22	2143.233 2	806.73	0.157E-21	P(23)	57	2147.564 66(3)	442.25	0.129E-20	P(32)
23	2143.402 42(5)*	2320.08	0.850E-22	P(74)	58	2147.827 56(60)	2307.58	0.458E-22	P(36)
24	2143.430 89(8)*	2279.17	0.896E-22	P(63)	59	2148.025 5	2154.45	0.128E-21	P(48)
25	2143.590 66(8)*	2275.99	0.910E-22	P(63)	60	2148.042 3	719.02	0.189E-21	P(18)
26	2144.010 4	2291.02	0.693E-22	P(51)	61	2148.076 2	718.75	0.189E-21	P(18)
27	2144.037 7	2290.64	0.695E-22	P(51)	62	2148.106 3	2265.33	0.739E-22	P(48)
28	2144.171 9	787.87	0.165E-21	P(22)	63	2148.368 24(4)	1200.98	0.519E-22	P(54)
29	2144.214 8	787.46	0.165E-21	P(22)	64	2148.412 71(8)*	2073.21	0.230E-21	P(59)
30	2144.399 29(3)	527.64	0.926E-21	P(35)	65	2148.558 43(8)*	2070.42	0.233E-21	P(59)
31	2144.534 4	2280.07	0.733E-22	P(51)	66	2148.606 76(3)	415.46	0.142E-20	P(31)
32	2144.686 18(8)*	2226.43	0.114E-21	P(62)	67	2148.757 59(24)	2279.28	0.512E-22	P(35)
33	2144.731 92(5)*	2258.36	0.113E-21	P(73)	68	2148.896 03(59)	2277.41	0.517E-22	P(35)
34	2144.842 37(8)*	2223.36	0.116E-21	P(62)	69	2148.993 6	703.91	0.192E-21	P(17)
35	2144.849 06(5)	1336.67	0.282E-22	P(57)	70	2149.025 4	703.66	0.192E-21	P(17)

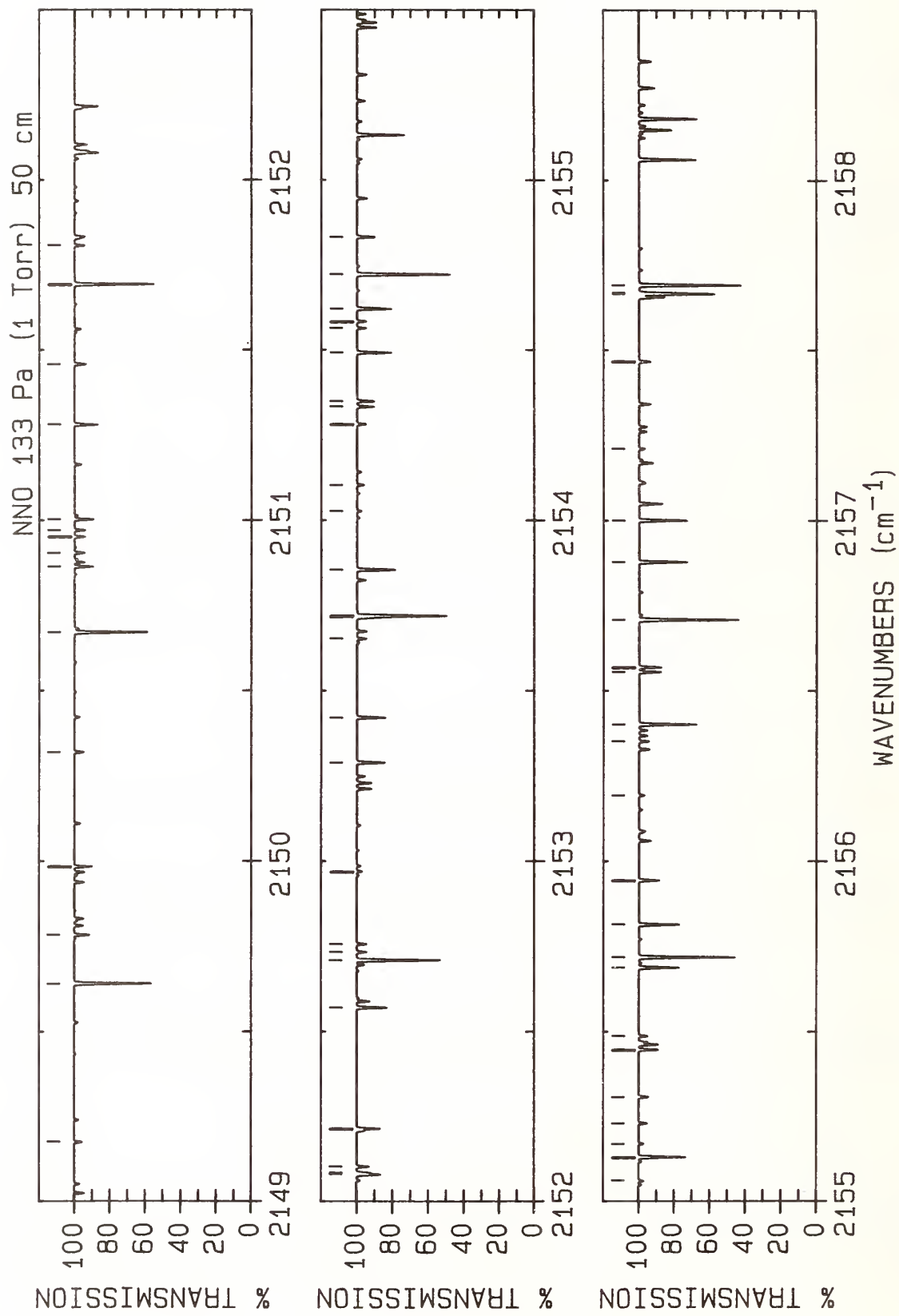

LINE #	WAVENUMBER(unc) (cm ⁻¹)	LOWER STATE (cm ⁻¹)	INTENSITY (cm/molecule)	ASSIGNMENT ROTATION BAND	LINE #	WAVENUMBER(unc) (cm ⁻¹)	LOWER STATE (cm ⁻¹)	INTENSITY (cm/molecule)	ASSIGNMENT ROTATION BAND
1	2149.176 2	2114.24	0.152E-21	P(47) G	36	2154.333 5	1936.08	0.324E-21	P(42) E
2	2149.641 76(8)*	2023.80	0.288E-21	P(58) C	37	2154.349 5	1935.90	0.324E-21	P(42) F
3	2149.642 35(3)	389.50	0.156E-20	P(30) P	38	2154.492 22(8)*	1834.50	0.677E-21	P(54) C
4	2149.784 06(8)*	2021.11	0.292E-21	P(58) B	39	2154.564 4	630.86	0.177E-21	P(11) O
5	2149.984 36(5)*	2019.71	0.344E-21	P(69) A	40	2154.583 9	630.75	0.177E-21	P(11) N
6	2150.320 5	2074.87	0.180E-21	P(46) G	41	2154.621 21(8)*	1832.15	0.684E-21	P(54) B
7	2150.671 41(3)	364.38	0.171E-20	P(29) P	42	2154.722 36(3)	272.26	0.231E-20	P(25) P
8	2150.864 24(8)*	1975.23	0.359E-21	P(57) C	43	2154.832 4	1925.71	0.342E-21	P(42) G
9	2150.904 2	676.01	0.194E-21	P(15) N	44	2155.060 97(18)	2115.24	0.947E-22	P(29) K
10	2150.951 6	2046.86	0.202E-21	P(45) E	45	2155.131 61(5)*	1794.32	0.978E-21	P(65) A
11	2150.971 0	2046.63	0.202E-21	P(45) F	46	2155.170 89(50)	2113.94	0.953E-22	P(29) J
12	2151.003 17(8)*	1972.62	0.363E-21	P(57) B	47	2155.231 20(3)	951.32	0.157E-21	P(48) R
13	2151.281 05(5)*	1962.12	0.450E-21	P(68) A	48	2155.308 59(30)	2108.39	0.936E-22	P(28) M
14	2151.458 2	2036.33	0.213E-21	P(45) G	49	2155.308 75(30)	2108.39	0.936E-22	P(28) L
15	2151.693 95(3)	340.10	0.186E-20	P(28) P	50	2155.447 6	1900.83	0.376E-21	P(41) E
16	2151.808 4	663.61	0.193E-21	P(14) O	51	2155.487 5	621.53	0.168E-21	P(10) N
17	2152.080 15(8)*	1927.48	0.445E-21	P(56) C	52	2155.688 37(8)*	1789.25	0.829E-21	P(53) C
18	2152.085 5	2009.10	0.238E-21	P(44) E	53	2155.718 75(3)	251.32	0.246E-20	P(24) P
19	2152.103 7	2008.88	0.238E-21	P(44) F	54	2155.814 12(8)*	1786.99	0.838E-21	P(53) B
20	2152.215 73(8)*	1924.97	0.451E-21	P(56) B	55	2155.944 1	1890.51	0.396E-21	P(41) G
21	2152.571 15(5)*	1905.36	0.585E-21	P(67) A	56	2156.194 00(48)	2089.63	0.104E-21	P(28) J
22	2152.709 96(3)	316.65	0.201E-20	P(27) P	57	2156.352 23(3)	912.53	0.186E-21	P(47) R
23	2152.733 6	651.85	0.189E-21	P(13) O	58	2156.401 95(5)*	1740.04	0.126E-20	P(64) A
24	2152.757 1	651.71	0.189E-21	P(13) N	59	2156.555 2	1866.41	0.434E-21	P(40) E
25	2152.969 58(4)	1031.32	0.110E-21	P(50) R	60	2156.569 1	1866.26	0.435E-21	P(40) F
26	2153.289 48(8)*	1880.57	0.550E-21	P(55) C	61	2156.708 59(3)	231.22	0.260E-20	P(23) P
27	2153.421 74(8)*	1878.14	0.557E-21	P(55) B	62	2156.877 92(8)*	1744.84	0.101E-20	P(52) C
28	2153.652 2	640.94	0.184E-21	P(12) O	63	2157.000 47(8)*	1742.67	0.102E-20	P(52) B
29	2153.714 2	1961.75	0.293E-21	P(43) G	64	2157.210 61(46)	2066.15	0.112E-21	P(27) J
30	2153.719 43(3)	294.04	0.216E-20	P(26) P	65	2157.466 75(3)	874.54	0.219E-21	P(46) R
31	2153.854 68(5)*	1849.42	0.758E-21	P(66) A	66	2157.665 69(5)*	1686.59	0.161E-20	P(63) A
32	2154.026 74(18)	2140.48	0.865E-22	P(30) K	67	2157.669 1	1832.70	0.499E-21	P(39) F
33	2154.103 65(3)	990.92	0.132E-21	P(49) R	68	2157.691 87(3)	211.96	0.273E-20	P(22) P
34	2154.282 10(32)	2132.77	0.861E-22	P(29) M					
35	2154.282 30(32)	2132.77	0.861E-22	P(29) L					

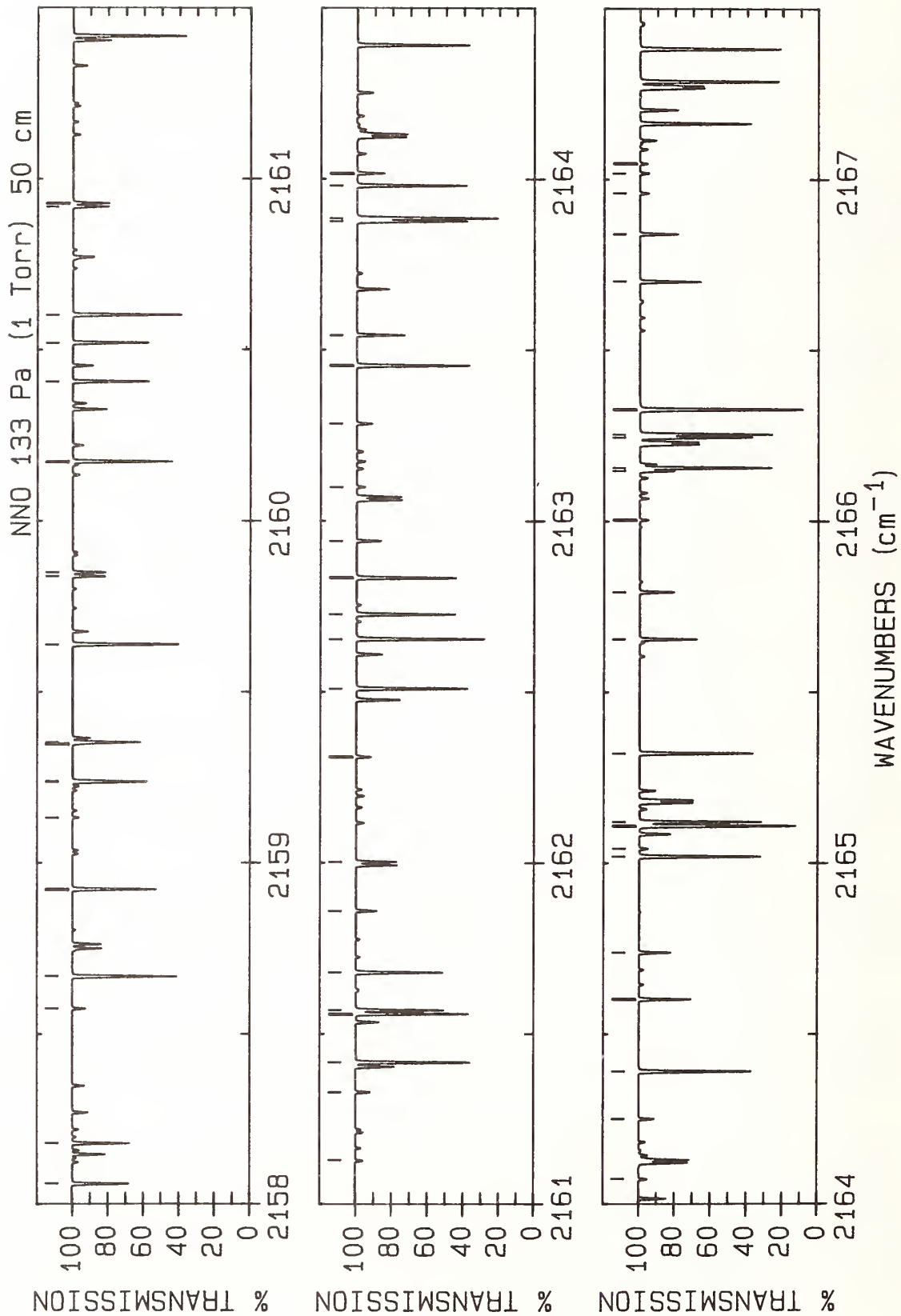

LINE #	WAVENUMBER(unc) (cm ⁻¹)	LOWER STATE (cm ⁻¹)	INTENSITY (cm/molecule)	ASSIGNMENT ROTATION BAND	LINE #	WAVENUMBER(unc) (cm ⁻¹)	LOWER STATE (cm ⁻¹)	INTENSITY (cm/molecule)	ASSIGNMENT ROTATION BAND
1	2158.060 88(8)*	1701.27	0.123E-20	P(51) C	36	2162.941 26(3)	696.68	0.466E-21	P(41) R
2	2158.180 25(8)*	1699.17	0.124E-20	P(51) B	37	2163.098 60(13)	1943.56	0.159E-21	P(21) K
3	2158.574 73(3)	837.35	0.257E-21	P(45) R	38	2163.284 18(17)	1943.56	0.148E-21	P(20) M
4	2158.668 60(3)	193.53	0.285E-20	P(21) P	39	2163.284 22(17)	1943.56	0.148E-21	P(20) L
5	2158.922 83(5)*	1633.97	0.204E-20	P(62) A	40	2163.453 68(3)	113.95	0.321E-20	P(16) P
6	2159.132 34(15)	2022.67	0.128E-21	P(25) K	41	2163.542 9	1667.49	0.980E-21	P(34) G
7	2159.237 22(8)*	1658.53	0.148E-20	P(50) C	42	2163.876 46(8)*	1495.90	0.302E-20	P(46) C
8	2159.240 0	1789.92	0.601E-21	P(38) G	43	2163.885 20(5)*	1431.79	0.514E-20	P(58) A
9	2159.348 95(24)	2019.25	0.124E-21	P(24) M	44	2163.980 49(8)*	1494.20	0.305E-20	P(46) B
10	2159.349 03(24)	2019.25	0.124E-21	P(24) L	45	2164.016 53(3)	663.53	0.534E-21	P(40) R
11	2159.353 47(8)*	1656.51	0.150E-20	P(50) B	46	2164.073 70(12)	1925.88	0.165E-21	P(20) K
12	2159.638 76(3)	175.94	0.296E-20	P(20) P	47	2164.251 53(16)	1926.74	0.153E-21	P(19) M
13	2159.838 1	1768.20	0.649E-21	P(37) E	48	2164.251 56(16)	1926.74	0.153E-21	P(19) L
14	2159.849 3	1768.08	0.650E-21	P(37) F	49	2164.390 96(3)	100.55	0.322E-20	P(15) P
15	2160.173 35(5)*	1582.18	0.259E-20	P(61) A	50	2164.602 3	1638.97	0.109E-20	P(33) G
16	2160.406 96(8)*	1616.62	0.178E-20	P(49) C	51	2164.738 6	1752.85	0.624E-21	P(33) D
17	2160.520 10(8)*	1614.68	0.180E-20	P(49) B	52	2165.019 70(8)*	1457.34	0.357E-20	P(45) C
18	2160.602 35(3)	159.19	0.306E-20	P(19) P	53	2165.042 20(12)	1909.04	0.170E-21	P(19) K
19	2160.919 2	1737.13	0.735E-21	P(36) E	54	2165.108 87(29)	1908.48	0.171E-21	P(19) J
20	2160.929 5	1737.03	0.736E-21	P(36) F	55	2165.109 23(5)*	1383.33	0.641E-20	P(57) A
21	2161.128 63(14)	1981.43	0.145E-21	P(23) K	56	2165.120 77(8)*	1455.70	0.360E-20	P(45) B
22	2161.329 73(20)	1979.73	0.137E-21	P(22) M	57	2165.321 65(3)	87.98	0.319E-20	P(14) P
23	2161.329 78(20)	1979.73	0.137E-21	P(22) L	58	2165.655 1	1611.29	0.121E-20	P(32) G
24	2161.417 26(5)*	1531.22	0.327E-20	P(60) A	59	2165.792 9	1725.33	0.693E-21	P(32) D
25	2161.559 38(3)	143.27	0.313E-20	P(18) P	60	2166.004 10(12)	1893.05	0.174E-21	P(18) K
26	2161.570 08(8)*	1575.55	0.214E-20	P(48) C	61	2166.147 39(3)	599.64	0.694E-21	P(38) R
27	2161.680 15(8)*	1573.69	0.215E-20	P(48) B	62	2166.156 30(8)*	1419.61	0.420E-20	P(44) C
28	2161.859 45(3)	730.64	0.404E-21	P(42) R	63	2166.245 74(3)	76.25	0.314E-20	P(13) P
29	2162.003 2	1706.82	0.829E-21	P(35) F	64	2166.254 44(8)*	1418.04	0.423E-20	P(44) B
30	2162.310 25(19)	1961.23	0.143E-21	P(21) M	65	2166.326 62(5)*	1335.69	0.795E-20	P(56) A
31	2162.310 29(19)	1961.23	0.143E-21	P(21) L	66	2166.701 3	1584.45	0.134E-20	P(31) G
32	2162.509 82(3)	128.19	0.318E-20	P(17) P	67	2166.840 4	1698.65	0.765E-21	P(31) D
33	2162.654 54(5)*	1481.09	0.411E-20	P(59) A	68	2166.959 39(12)	1877.89	0.177E-21	P(17) K
34	2162.726 58(8)*	1535.31	0.255E-20	P(47) C	69	2167.018 07(25)	1877.44	0.178E-21	P(17) J
35	2162.833 62(8)*	1533.53	0.257E-20	P(47) B	70	2167.046 5	809.25	0.153E-21	P(23) W

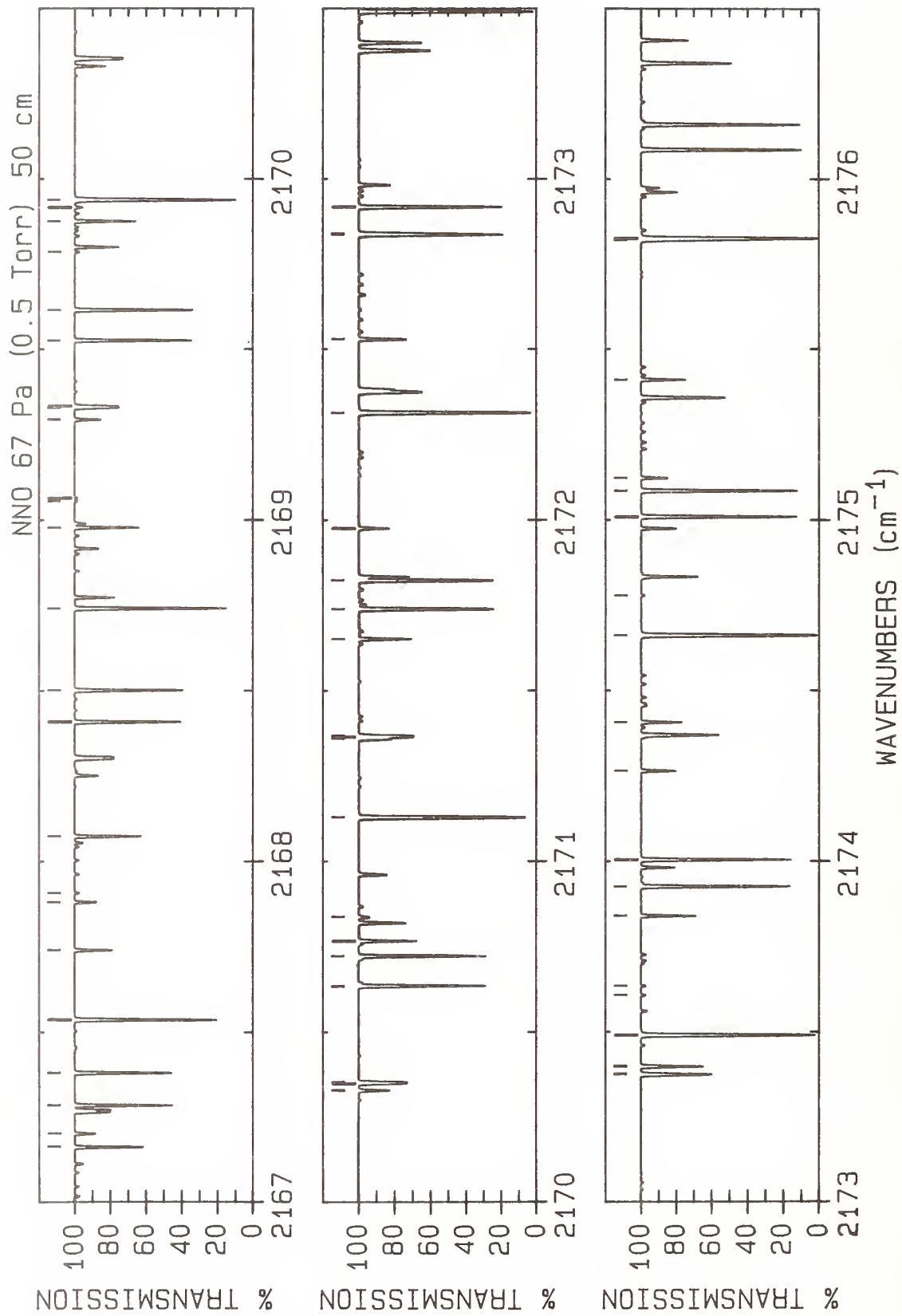

LINE #	WAVENUMBER(unc) (cm ⁻¹)	LOWER STATE (cm ⁻¹)	INTENSITY (cm/molecule)	ASSIGNMENT ROTATION BAND	LINE #	WAVENUMBER(unc) (cm ⁻¹)	LOWER STATE (cm ⁻¹)	INTENSITY (cm/molecule)	ASSIGNMENT ROTATION BAND
1	2167.163 23(3)	65.36	0.306E-20	P(12)	36	2170.838 11(11)	1832.53	0.147E-21	P(12)
2	2167.202 97(3)	568.91	0.785E-21	P(37)	37	2170.838 11(11)	1832.53	0.147E-21	P(12)
3	2167.286 27(8)*	1382.71	0.492E-20	P(43)	38	2171.129 71(5)*	1153.46	0.180E-19	P(52)
4	2167.381 51(8)*	1381.21	0.495E-20	P(43)	39	2171.359 56(3)	454.04	0.123E-20	P(33)
5	2167.537 37(5)*	1288.88	0.981E-20	P(55)	40	2171.365 0	1472.61	0.193E-20	P(26)
6	2167.740 9	1558.45	0.147E-20	P(30)	41	2171.369 1	1472.58	0.193E-20	P(26)
7	2167.880 8	1672.80	0.840E-21	P(30)	42	2171.651 55(4)	23.46	0.219E-20	P(7)
8	2167.908 07(12)	1863.58	0.179E-21	P(16)	43	2171.739 62(8)*	1243.48	0.882E-20	P(39)
9	2168.074 12(3)	55.30	0.294E-20	P(11)	44	2171.823 59(8)*	1242.25	0.887E-20	P(39)
10	2168.409 59(8)*	1346.65	0.573E-20	P(42)	45	2171.975 8	1577.73	0.116E-20	P(26)
11	2168.501 96(8)*	1345.22	0.577E-20	P(42)	46	2172.313 84(5)*	1109.98	0.218E-19	P(51)
12	2168.741 47(5)*	1242.91	0.121E-19	P(54)	47	2172.529 36(4)	17.60	0.193E-20	P(6)
13	2168.978 40(3)	46.09	0.280E-20	P(10)	48	2172.836 31(8)*	1210.77	0.101E-19	P(38)
14	2169.055 7	588.01	0.117E-21	R(5)	49	2172.840 3	1440.98	0.218E-20	P(25)
15	2169.064 7	588.03	0.117E-21	R(5)	50	2172.917 54(8)*	1209.60	0.101E-19	P(38)
16	2169.294 42(3)	509.86	0.992E-21	P(35)	51	2173.374 4	1429.78	0.220E-20	P(24)
17	2169.295 5	1140.35	0.261E-22	P(37)	52	2173.377 6	1429.76	0.220E-20	P(24)
18	2169.328 41(3)	1007.69	0.666E-22	P(50)	53	2173.398 34(3)	401.46	0.149E-20	P(31)
19	2169.329 0	1518.81	0.166E-20	P(28)	54	2173.400 53(4)	12.57	0.165E-20	P(5)
20	2169.334 1	1518.77	0.166E-20	P(28)	55	2173.491 30(5)*	1067.33	0.264E-19	P(50)
21	2169.526 26(8)*	1311.42	0.665E-20	P(41)	56	2173.608 5	695.67	0.185E-21	P(16)
22	2169.615 79(8)*	1310.06	0.669E-20	P(41)	57	2173.635 7	695.47	0.185E-21	P(16)
23	2169.785 56(12)	1837.48	0.178E-21	P(14)	58	2173.840 4	1420.00	0.232E-20	P(24)
24	2169.876 07(3)	37.71	0.263E-20	P(9)	59	2173.926 32(8)*	1178.89	0.115E-19	P(37)
25	2169.917 00(11)	1843.47	0.152E-21	P(13)	60	2174.004 85(8)*	1177.78	0.115E-19	P(37)
26	2169.917 01(11)	1843.47	0.152E-21	P(13)	61	2174.265 07(4)	8.38	0.135E-20	P(4)
27	2169.938 92(5)*	1197.77	0.148E-19	P(53)	62	2174.407 84(3)	376.38	0.164E-20	P(30)
28	2170.328 8	1956.24	0.920E-22	P(13)	63	2174.662 09(5)*	1025.52	0.317E-19	P(49)
29	2170.330 28(3)	481.55	0.111E-20	P(34)	64	2174.778 59(3)	818.17	0.151E-21	P(45)
30	2170.350 4	1495.29	0.180E-20	P(27)	65	2175.009 67(8)*	1147.85	0.130E-19	P(36)
31	2170.354 9	1495.26	0.180E-20	P(27)	66	2175.085 52(8)*	1146.80	0.131E-19	P(36)
32	2170.633 4	598.90	0.150E-21	R(7)	67	2175.122 97(4)	5.03	0.103E-20	P(3)
33	2170.636 27(8)*	1277.04	0.767E-20	P(40)	68	2175.410 75(3)	352.10	0.178E-20	P(29)
34	2170.723 00(8)*	1275.74	0.772E-20	P(40)	69	2175.820 7	1380.55	0.258E-20	P(22)
35	2170.767 12(4)	30.17	0.242E-20	P(8)	70	2175.826 20(5)*	984.54	0.380E-19	P(48)

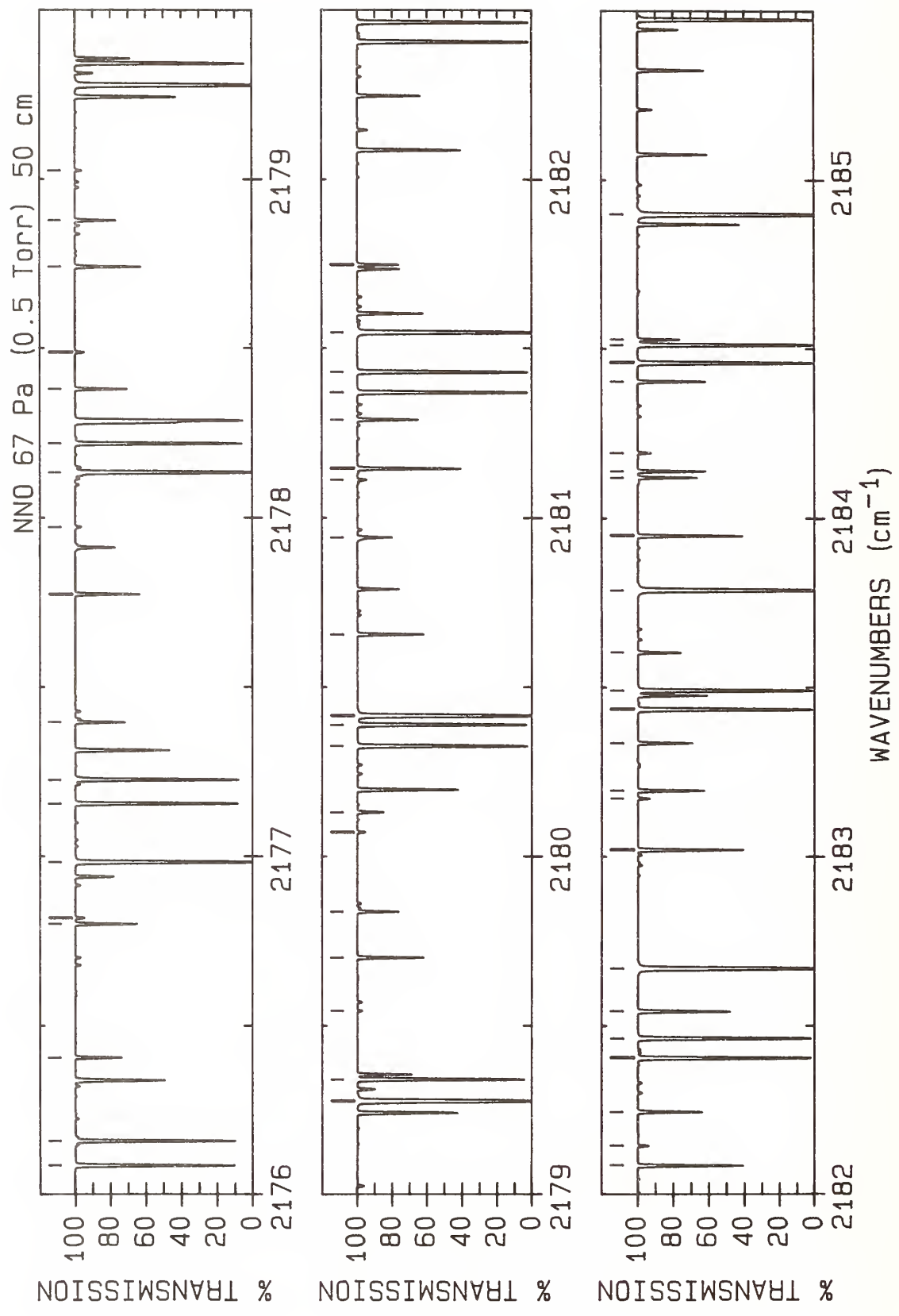

LINE #	WAVENUMBER(unc) (cm ⁻¹)	LOWER STATE (cm ⁻¹)	INTENSITY (cm/molecule)	ASSIGNMENT ROTATION BAND	LINE #	WAVENUMBER(unc) (cm ⁻¹)	LOWER STATE (cm ⁻¹)	INTENSITY (cm/molecule)	ASSIGNMENT ROTATION BAND
1	2176.086 33(8)*	1117.64	0.146E-19	P(35) C	36	2181.289 32(3)	223.43	0.265E-20	P(23) R
2	2176.159 53(8)*	1116.65	0.147E-19	P(35) B	37	2181.369 26(8)*	979.18	0.247E-19	P(30) C
3	2176.407 04(3)	328.64	0.193E-20	P(28) R	38	2181.429 74(8)*	978.45	0.248E-19	P(30) B
4	2176.800 9	1362.08	0.270E-20	P(21) G	39	2181.546 42(5)*	792.14	0.873E-19	P(43) A
5	2176.818 85(4)	0.84	0.350E-21	P(1) P	40	2181.746 70(4)	8.38	0.169E-20	P(4) P
6	2176.983 63(5)*	944.39	0.453E-19	P(47) A	41	2182.085 7	1278.57	0.286E-20	P(15) E
7	2177.156 30(8)*	1088.28	0.164E-19	P(34) C	42	2182.086 5	1278.56	0.286E-20	P(15) F
8	2177.226 90(8)*	1087.34	0.165E-19	P(34) B	43	2182.145 31(3)	585.90	0.399E-21	P(38) T
9	2177.396 73(3)	305.98	0.208E-20	P(27) R	44	2182.245 90(3)	204.82	0.278E-20	P(22) R
10	2177.774 5	1344.45	0.280E-20	P(20) G	45	2182.405 75(8)*	954.01	0.270E-19	P(29) C
11	2177.973 48(3)	713.90	0.236E-21	P(42) T	46	2182.463 76(8)*	953.32	0.271E-19	P(29) B
12	2178.134 37(5)*	905.08	0.537E-19	P(46) A	47	2182.542 8	1268.90	0.305E-20	P(15) G
13	2178.219 59(8)*	1059.75	0.183E-19	P(33) C	48	2182.544 66(4)	12.57	0.199E-20	P(5) P
14	2178.379 81(3)	284.13	0.223E-20	P(26) R	49	2182.670 36(5)*	756.16	0.102E-18	P(42) A
15	2178.488 11(4)	0.00	0.352E-21	R(0) P	50	2183.020 1	1265.97	0.283E-20	P(14) E
16	2178.741 4	1327.67	0.289E-20	P(19) G	51	2183.020 8	1265.96	0.283E-20	P(14) F
17	2178.878 4	1443.43	0.164E-20	P(19) D	52	2183.172 53(3)	555.87	0.450E-21	P(37) T
18	2179.025 88(3)	680.72	0.271E-21	P(41) T	53	2183.195 85(3)	187.01	0.290E-20	P(21) R
19	2179.276 18(8)*	1032.06	0.204E-19	P(32) C	54	2183.335 95(4)	17.60	0.226E-20	P(6) P
20	2179.278 42(5)*	866.60	0.634E-19	P(45) A	55	2183.435 51(8)*	929.66	0.294E-19	P(28) C
21	2179.341 66(8)*	1031.22	0.204E-19	P(32) B	56	2183.491 11(8)*	929.02	0.295E-19	P(28) B
22	2179.544 4	734.67	0.197E-21	R(19) N	57	2183.603 2	1372.52	0.171E-20	P(14) D
23	2179.701 7	1311.72	0.296E-20	P(18) G	58	2183.787 59(5)*	721.01	0.118E-18	P(41) A
24	2179.837 1	1427.58	0.168E-20	P(18) D	59	2183.947 9	1254.20	0.277E-20	P(13) E
25	2180.071 98(3)	648.32	0.309E-21	P(40) T	60	2183.948 4	1254.20	0.277E-20	P(13) F
26	2180.130 74(4)	2.51	0.104E-20	R(2) P	61	2184.120 55(3)	23.46	0.251E-20	R(7) P
27	2180.326 08(8)*	1005.20	0.225E-19	P(31) C	62	2184.139 17(3)	170.01	0.300E-20	P(20) R
28	2180.326 11(3)	242.85	0.252E-20	P(24) R	63	2184.193 44(3)	526.63	0.505E-21	P(36) T
29	2180.389 03(8)*	1004.42	0.226E-19	P(31) B	64	2184.403 5	1244.55	0.298E-20	P(13) G
30	2180.415 77(5)*	828.95	0.746E-19	P(44) A	65	2184.458 56(8)*	906.16	0.318E-19	P(27) C
31	2180.655 4	1296.61	0.301E-20	P(17) G	66	2184.511 77(8)*	905.56	0.319E-19	P(27) B
32	2180.942 06(4)	5.03	0.137E-20	R(3) P	67	2184.527 5	1360.84	0.168E-20	P(13) D
33	2181.111 80(3)	616.72	0.352E-21	P(39) T	68	2184.898 10(5)*	686.70	0.136E-18	P(40) A
34	2181.144 5	1292.01	0.286E-20	P(16) E	69	2184.898 46(3)	30.17	0.274E-20	R(8) P
35	2181.145 5	1292.01	0.286E-20	P(16) F					

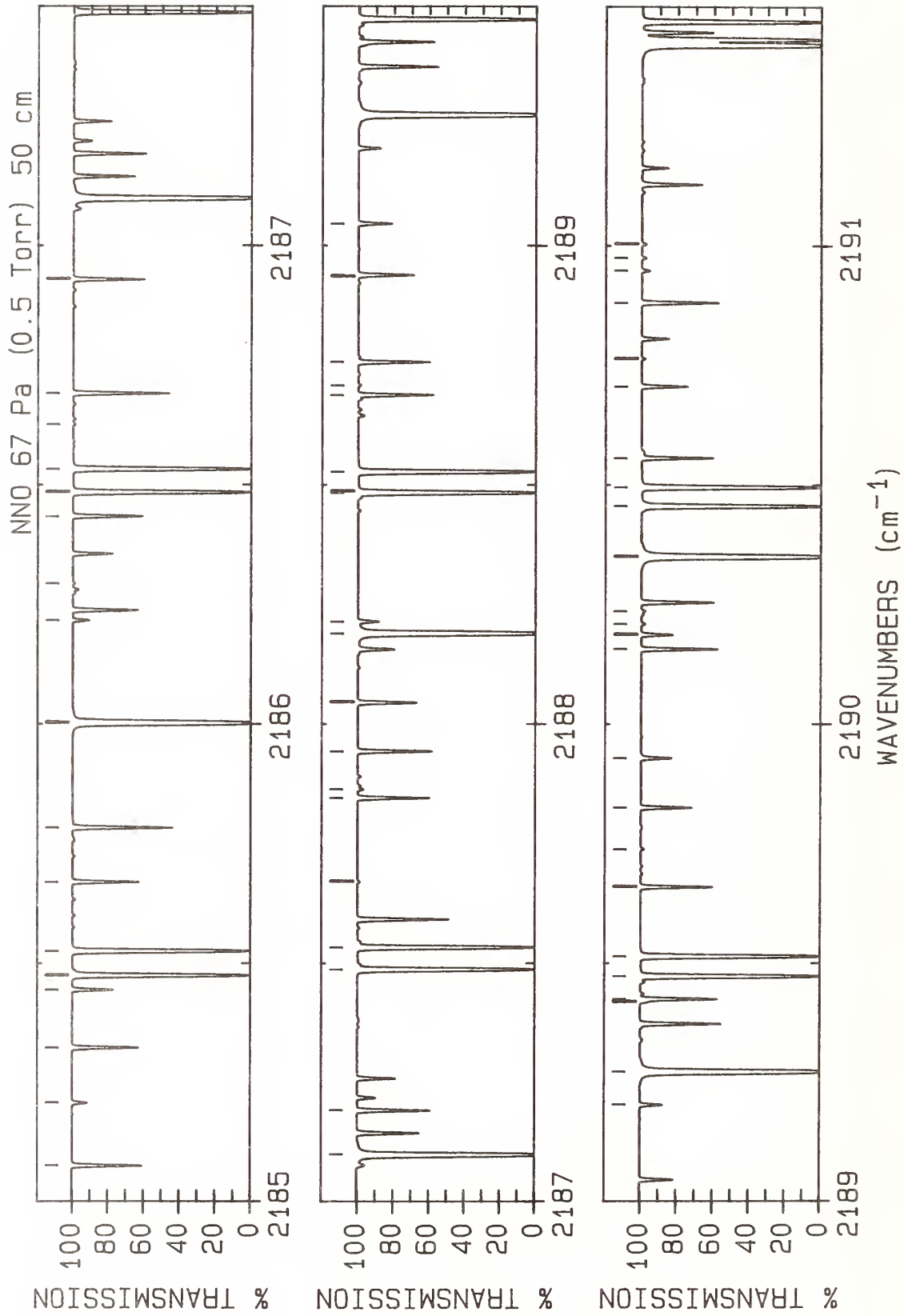

LINE #	WAVENUMBER(unc) (cm ⁻¹)	LOWER STATE (cm ⁻¹)	INTENSITY (cm/molecule)	ASSIGNMENT ROTATION BAND	LINE #	WAVENUMBER(unc) (cm ⁻¹)	LOWER STATE (cm ⁻¹)	INTENSITY (cm/molecule)	ASSIGNMENT ROTATION BAND
1	2185.075 84(3)	153.82	0.308E-20	P(19)	36	2188.527 43(8)*	820.10	0.413E-19	P(23)
2	2185.208 03(3)	498.18	0.565E-21	P(35)	37	2188.687 55(3)	76.25	0.341E-20	R(13)
3	2185.323 8	1233.63	0.290E-20	P(12)	38	2188.707 56(4)	483.70	0.116E-21	P(34)
4	2185.445 0	1349.99	0.164E-20	P(12)	39	2188.756 02(3)	97.16	0.321E-20	P(15)
5	2185.474 89(8)*	883.50	0.342E-19	P(26)	40	2188.934 6	1910.39	0.796E-22	R(8)
6	2185.525 73(8)*	882.94	0.343E-19	P(26)	41	2188.938 4	1198.37	0.230E-20	P(8)
7	2185.669 68(3)	37.71	0.293E-20	R(9)	42	2189.045 8	1314.94	0.129E-20	P(8)
8	2185.783 2	1233.20	0.258E-20	P(11)	43	2189.203 22(3)	392.26	0.840E-21	P(31)
9	2185.783 5	1233.20	0.258E-20	P(11)	44	2189.272 88(5)*	557.81	0.230E-18	P(36)
10	2186.001 89(5)*	653.23	0.156E-18	P(39)	45	2189.419 12(12)	1804.77	0.137E-21	R(9)
11	2186.005 86(3)	138.44	0.315E-20	P(18)	46	2189.419 12(12)	1804.77	0.137E-21	R(9)
12	2186.216 31(3)	470.51	0.628E-21	P(34)	47	2189.425 24(3)	87.98	0.344E-20	R(14)
13	2186.293 41(15)	1757.49	0.909E-22	R(4)	48	2189.472 88(8)*	801.23	0.433E-19	P(22)
14	2186.434 20(3)	46.09	0.310E-20	R(10)	49	2189.514 58(8)*	800.83	0.434E-19	P(22)
15	2186.484 49(8)*	861.67	0.366E-19	P(25)	50	2189.659 43(3)	85.01	0.318E-20	R(14)
16	2186.533 00(8)*	861.16	0.367E-19	P(25)	51	2189.738 55(4)	456.08	0.129E-21	P(33)
17	2186.626 03(4)	541.39	0.926E-22	P(36)	52	2189.825 3	1191.65	0.208E-20	P(7)
18	2186.690 8	1223.96	0.243E-20	P(10)	53	2189.928 8	1308.27	0.117E-20	P(7)
19	2186.691 1	1223.96	0.243E-20	P(10)	54	2190.156 22(3)	100.55	0.346E-20	R(15)
20	2186.929 24(3)	123.87	0.319E-20	P(17)	55	2190.186 20(3)	367.75	0.917E-21	P(30)
21	2187.098 95(5)*	620.59	0.179E-18	P(38)	56	2190.186 84(11)	1813.18	0.147E-21	R(10)
22	2187.192 02(3)	55.30	0.323E-20	R(11)	57	2190.186 84(11)	1813.18	0.147E-21	R(10)
23	2187.487 36(8)*	840.68	0.390E-19	P(24)	58	2190.208 73(17)	1786.83	0.163E-21	R(9)
24	2187.533 57(8)*	840.21	0.391E-19	P(24)	59	2190.235 37(13)	1786.96	0.163E-21	R(9)
25	2187.670 06(4)	512.14	0.104E-21	P(35)	60	2190.349 74(5)*	527.67	0.259E-18	P(35)
26	2187.845 96(3)	110.11	0.322E-20	P(16)	61	2190.455 52(8)*	782.76	0.452E-19	P(21)
27	2187.863 55(13)	1790.47	0.111E-21	R(7)	62	2190.495 01(8)*	782.39	0.453E-19	P(21)
28	2187.863 55(13)	1790.47	0.111E-21	R(7)	63	2190.556 16(3)	73.68	0.312E-20	P(13)
29	2187.943 14(3)	65.36	0.333E-20	R(12)	64	2190.705 5	1185.77	0.183E-20	P(6)
30	2188.044 8	1205.92	0.249E-20	P(9)	65	2190.763 00(4)	429.26	0.142E-21	P(32)
31	2188.189 29(5)*	588.78	0.203E-18	P(37)	66	2190.880 48(3)	113.95	0.344E-20	R(16)
32	2188.213 91(3)	417.55	0.766E-21	P(32)	67	2190.947 85(11)	1822.44	0.155E-21	R(11)
33	2188.483 49(8)*	820.54	0.412E-19	P(23)	68	2190.947 85(11)	1822.44	0.155E-21	R(11)
34	2188.485 9	1207.99	0.206E-20	P(8)	69	2190.974 54(18)	1795.22	0.172E-21	R(10)
35	2188.486 0	1207.99	0.206E-20	P(8)	70	2191.003 51(13)	1795.38	0.172E-21	R(10)

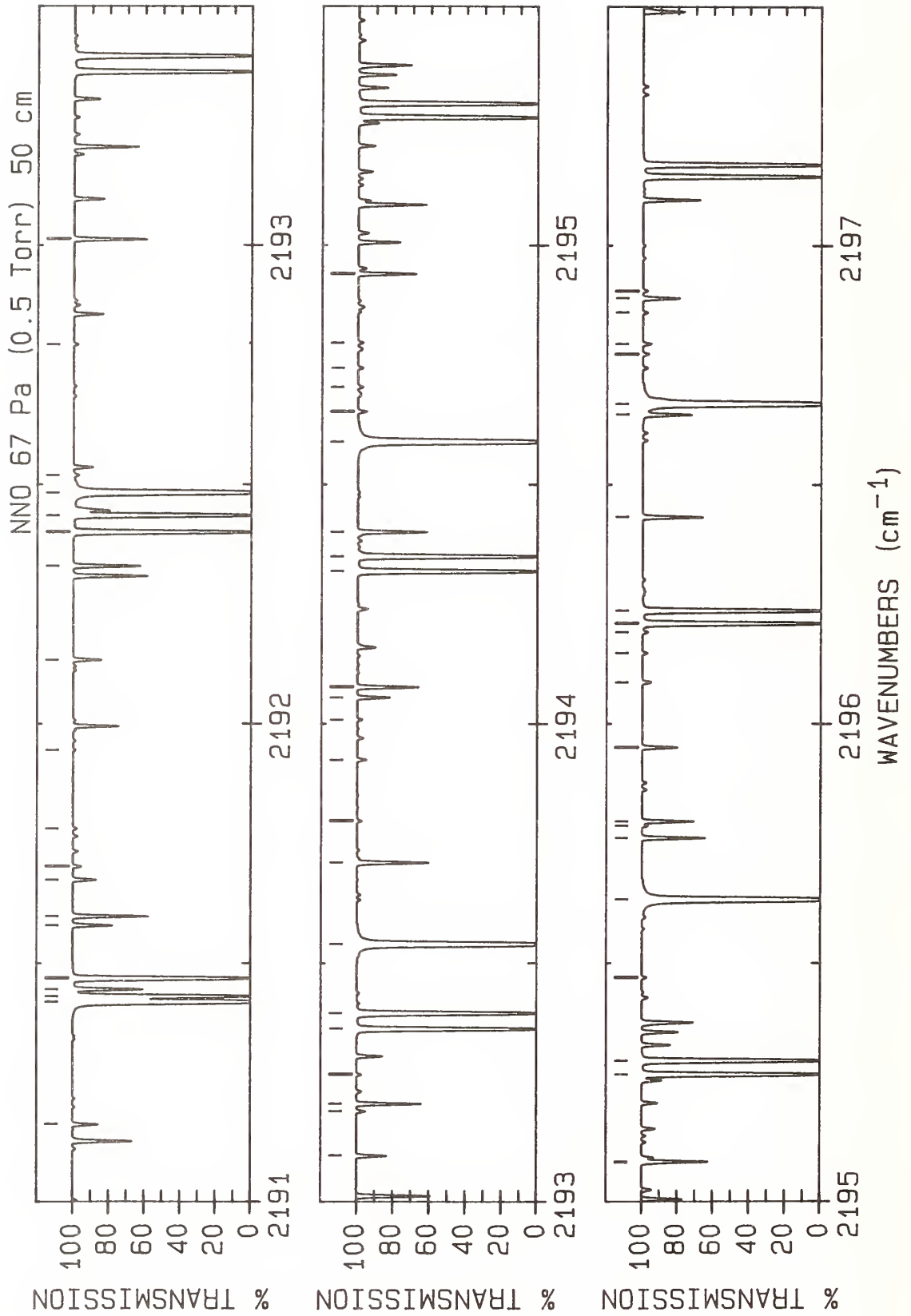

LINE #	WAVENUMBER(unc) (cm ⁻¹)	LOWER STATE (cm ⁻¹)	INTENSITY (cm/molecule)	ASSIGNMENT ROTATION BAND	LINE #	WAVENUMBER(unc) (cm ⁻¹)	LOWER STATE (cm ⁻¹)	INTENSITY (cm/molecule)	ASSIGNMENT ROTATION BAND
1	2191.162 84(3)	344.03	0.995E-21	P(29)	36	2194.318 54(8)*	717.26	0.505E-19	P(17) C
2	2191.419 84(5)*	498.37	0.291E-18	P(34)	37	2194.349 50(8)*	717.02	0.505E-19	P(17) B
3	2191.431 41(8)*	765.12	0.470E-19	P(20)	38	2194.400 81(3)	193.53	0.302E-20	R(21) P
4	2191.446 23(3)	63.15	0.304E-20	P(12)	39	2194.589 65(5)*	415.49	0.398E-18	P(31) A
5	2191.468 73(8)*	764.79	0.471E-19	P(20)	40	2194.652 06(14)	1881.32	0.171E-21	R(16) L
6	2191.579 0	1180.73	0.157E-20	P(5)	41	2194.652 08(14)	1881.32	0.171E-21	R(16) M
7	2191.598 01(3)	128.19	0.340E-20	R(17)	42	2194.703 04(25)	1849.75	0.193E-21	R(15) J
8	2191.674 0	1297.42	0.882E-21	P(5)	43	2194.742 76(12)	1850.11	0.193E-21	R(15) K
9	2191.702 14(11)	1832.53	0.162E-21	R(12)	44	2194.795 46(3)	330.11	0.203E-21	P(28) V
10	2191.702 14(11)	1832.53	0.162E-21	R(12)	45	2194.939 71(4)	29.15	0.239E-20	P(8) R
11	2191.780 93(4)	403.25	0.157E-21	P(31)	46	2195.081 3	1285.74	0.187E-21	P(1) D
12	2191.945 2	1945.39	0.976E-22	R(12)	47	2195.084 66(3)	211.96	0.289E-20	R(22) P
13	2192.133 15(3)	321.11	0.107E-20	P(28)	48	2195.267 39(8)*	702.99	0.509E-19	P(16) C
14	2192.329 62(3)	53.44	0.292E-20	P(11)	49	2195.296 29(8)*	702.77	0.510E-19	P(16) B
15	2192.400 55(8)*	748.33	0.485E-19	P(19)	50	2195.470 27(12)	1863.58	0.192E-21	R(16) K
16	2192.435 72(8)*	748.03	0.485E-19	P(19)	51	2195.632 72(5)*	389.53	0.437E-18	P(30) A
17	2192.483 20(5)*	469.91	0.324E-18	P(33)	52	2195.761 77(3)	231.22	0.274E-20	R(23) P
18	2192.519 53(12)	1814.75	0.185E-21	R(12)	53	2195.787 21(3)	307.35	0.218E-21	P(27) V
19	2192.792 31(4)	378.06	0.172E-21	P(30)	54	2195.796 37(4)	22.67	0.216E-20	P(7) R
20	2193.012 89(3)	159.19	0.325E-20	R(19)	55	2195.950 87(2)	237.29	0.139E-20	P(24) T
21	2193.097 11(2)	298.97	0.116E-20	P(27)	56	2196.086 63(17)	1910.76	0.167E-21	R(18) L
22	2193.190 56(12)	1855.24	0.170E-21	R(14)	57	2196.086 66(17)	1910.76	0.167E-21	R(18) M
23	2193.190 56(12)	1855.24	0.170E-21	R(14)	58	2196.147 41(29)	1877.44	0.190E-21	R(17) J
24	2193.206 33(3)	44.53	0.277E-20	P(10)	59	2196.190 99(12)	1877.89	0.189E-21	R(17) K
25	2193.267 38(12)	1825.69	0.190E-21	R(13)	60	2196.209 46(8)*	689.55	0.509E-19	P(15) C
26	2193.362 93(8)*	732.38	0.496E-19	P(18)	61	2196.236 33(8)*	689.36	0.510E-19	P(15) B
27	2193.395 98(8)*	732.11	0.497E-19	P(18)	62	2196.432 12(3)	251.32	0.259E-20	R(24) P
28	2193.539 80(5)*	442.28	0.360E-18	P(32)	63	2196.646 33(4)	17.00	0.191E-20	P(6) R
29	2193.710 22(3)	175.94	0.314E-20	R(20)	64	2196.669 03(5)*	364.41	0.478E-18	P(29) A
30	2193.797 16(3)	353.68	0.187E-21	P(29)	65	2196.772 41(3)	285.40	0.234E-21	P(26) V
31	2193.924 68(13)	1867.86	0.171E-21	R(15)	66	2196.793 81(19)	1926.74	0.163E-21	R(19) L
32	2193.924 69(13)	1867.86	0.171E-21	R(15)	67	2196.793 85(19)	1926.74	0.163E-21	R(19) M
33	2194.008 46(12)	1837.48	0.192E-21	R(14)	68	2196.859 50(31)	1892.54	0.186E-21	R(18) J
34	2194.054 72(2)	277.62	0.124E-20	P(26)	69	2196.889 42(2)	218.31	0.146E-20	P(23) T
35	2194.076 36(3)	36.44	0.260E-20	P(9)	70	2196.904 92(12)	1893.05	0.186E-21	R(18) K

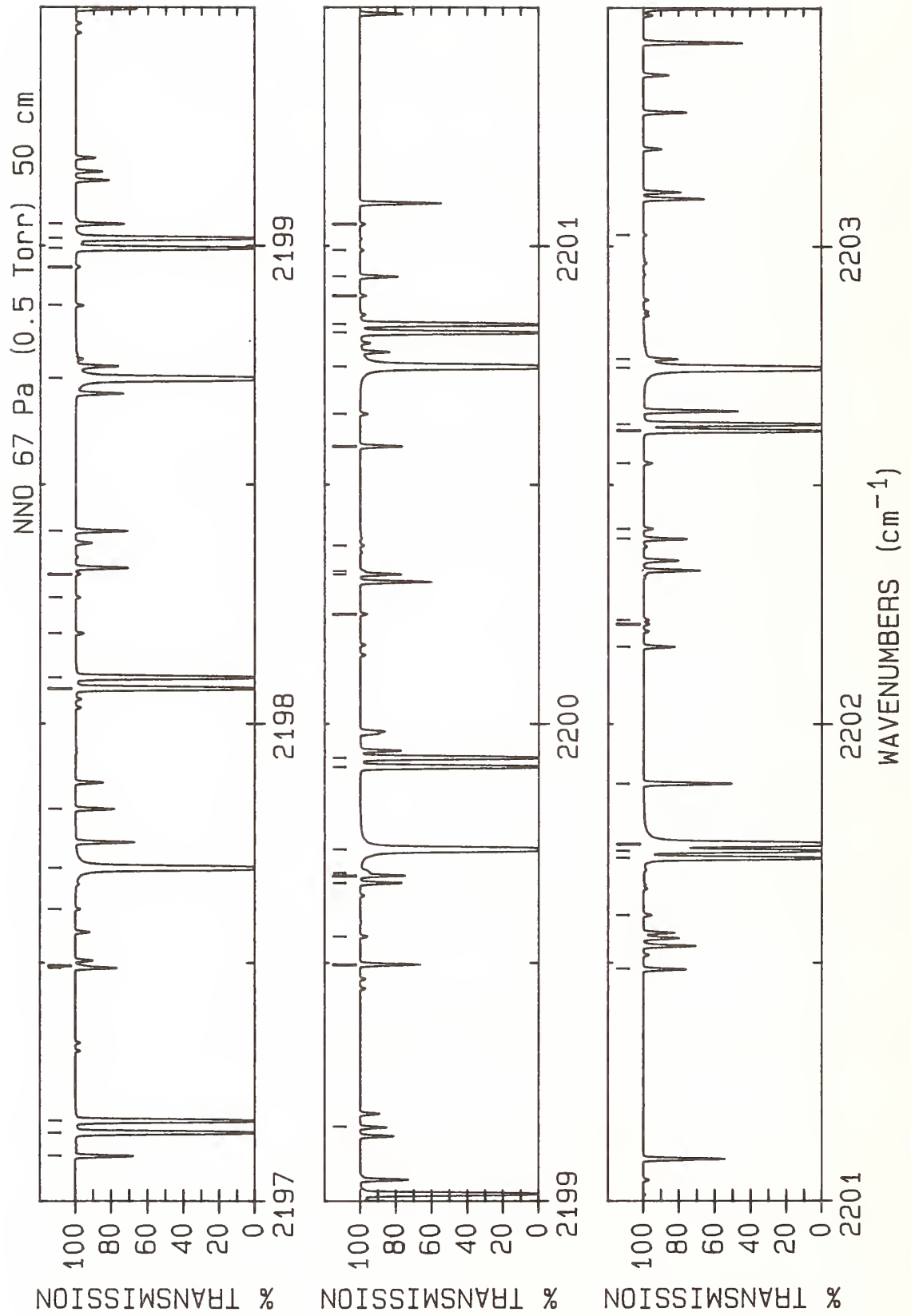

LINE #	WAVENUMBER(unc) (cm ⁻¹)	LOWER STATE (cm ⁻¹)	INTENSITY (cm/molecule)	ASSIGNMENT ROTATION BAND	LINE #	WAVENUMBER(unc) (cm ⁻¹)	LOWER STATE (cm ⁻¹)	INTENSITY (cm/molecule)	ASSIGNMENT ROTATION BAND
1	2197.095 71(3)	272.26	0.243E-20	R(25) P	36	2200.228 58(27)	2019.25	0.131E-21	R(24) M
2	2197.144 75(8)*	676.95	0.505E-19	P(14) C	37	2200.312 21(3)	389.50	0.164E-20	R(30) P
3	2197.169 63(8)*	676.79	0.506E-19	P(14) B	38	2200.318 81(42)	1980.61	0.153E-21	R(23) J
4	2197.489 59(4)	12.15	0.163E-20	P(5) R	39	2200.372 42(15)	1981.43	0.153E-21	R(23) K
5	2197.494 24(20)	1943.56	0.158E-21	R(20) L	40	2200.579 89(2)	150.30	0.169E-20	P(19) T
6	2197.494 29(20)	1943.56	0.158E-21	R(20) M	41	2200.647 58(3)	205.73	0.293E-21	P(22) V
7	2197.612 04(13)	1909.04	0.181E-21	R(19) K	42	2200.746 47(5)*	272.28	0.647E-18	P(25) A
8	2197.698 57(5)*	340.12	0.520E-18	P(28) A	43	2200.818 06(8)*	634.96	0.441E-19	P(10) C
9	2197.821 59(2)	200.12	0.153E-20	P(22) T	44	2200.835 24(8)*	634.88	0.442E-19	P(10) B
10	2198.073 26(8)*	665.20	0.497E-19	P(13) C	45	2200.895 11(29)	2040.28	0.123E-21	R(25) L
11	2198.096 17(8)*	665.05	0.497E-19	P(13) B	46	2200.895 26(29)	2040.28	0.123E-21	R(25) M
12	2198.187 92(22)	1961.23	0.152E-21	R(21) L	47	2200.935 19(3)	415.46	0.149E-20	R(31) P
13	2198.187 99(22)	1961.23	0.152E-21	R(21) M	48	2200.990 41(44)	2000.74	0.145E-21	R(24) J
14	2198.263 47(35)	1925.25	0.176E-21	R(20) J	49	2201.044 2	2152.14	0.716E-22	R(25) I
15	2198.312 36(13)	1925.88	0.175E-21	R(20) K	50	2201.045 46(15)	2001.63	0.144E-21	R(24) K
16	2198.402 61(3)	316.65	0.211E-20	R(27) P	51	2201.486 57(2)	135.27	0.172E-20	P(18) T
17	2198.721 32(5)*	316.67	0.562E-18	P(27) A	52	2201.599 94(3)	187.85	0.305E-21	P(21) V
18	2198.874 86(24)	1979.73	0.145E-21	R(22) L	53	2201.719 40(8)*	626.56	0.413E-19	P(9) C
19	2198.874 94(24)	1979.73	0.145E-21	R(22) M	54	2201.734 72(8)*	626.49	0.413E-19	P(9) B
20	2198.955 33(38)	1942.87	0.169E-21	R(21) J	55	2201.748 87(5)*	251.34	0.688E-18	P(24) A
21	2198.994 99(8)*	654.28	0.483E-19	P(12) C	56	2201.875 3	1201.27	0.213E-20	R(7) F
22	2199.015 95(8)*	654.15	0.484E-19	P(12) B	57	2201.875 4	1201.27	0.213E-20	R(7) E
23	2199.045 92(3)	340.10	0.195E-20	R(28) P	58	2202.160 80(3)	469.88	0.121E-20	R(33) P
24	2199.156 01(4)	4.86	0.101E-20	P(3) R	59	2202.208 12(32)	2084.84	0.106E-21	R(27) L
25	2199.496 6	1186.15	0.129E-20	R(4) F	60	2202.208 35(32)	2084.84	0.106E-21	R(27) M
26	2199.496 6	1186.15	0.129E-20	R(4) E	61	2202.216 8	739.49	0.189E-21	R(19) W
27	2199.555 03(26)	1999.07	0.138E-21	R(23) L	62	2202.386 86(3)	121.03	0.174E-20	P(17) T
28	2199.555 13(26)	1999.07	0.138E-21	R(23) M	63	2202.408 29(4)	0.00	0.346E-21	R(0) R
29	2199.666 83(2)	166.12	0.164E-20	P(20) T	64	2202.545 72(3)	170.77	0.316E-21	P(20) V
30	2199.682 45(3)	364.38	0.179E-20	R(29) P	65	2202.613 93(8)*	619.00	0.380E-19	P(8) C
31	2199.688 64(3)	224.43	0.279E-21	P(23) V	66	2202.627 43(8)*	618.95	0.380E-19	P(8) B
32	2199.737 29(5)*	294.06	0.605E-18	P(26) A	67	2202.744 46(5)*	231.24	0.728E-18	P(23) A
33	2199.909 92(8)*	644.20	0.465E-19	P(11) C	68	2202.763 42(3)	498.34	0.109E-20	R(34) P
34	2199.928 98(8)*	644.10	0.465E-19	P(11) B	69	2203.023 56(18)	2067.28	0.117E-21	R(27) K
35	2200.228 45(27)	2019.25	0.131E-21	R(24) L					

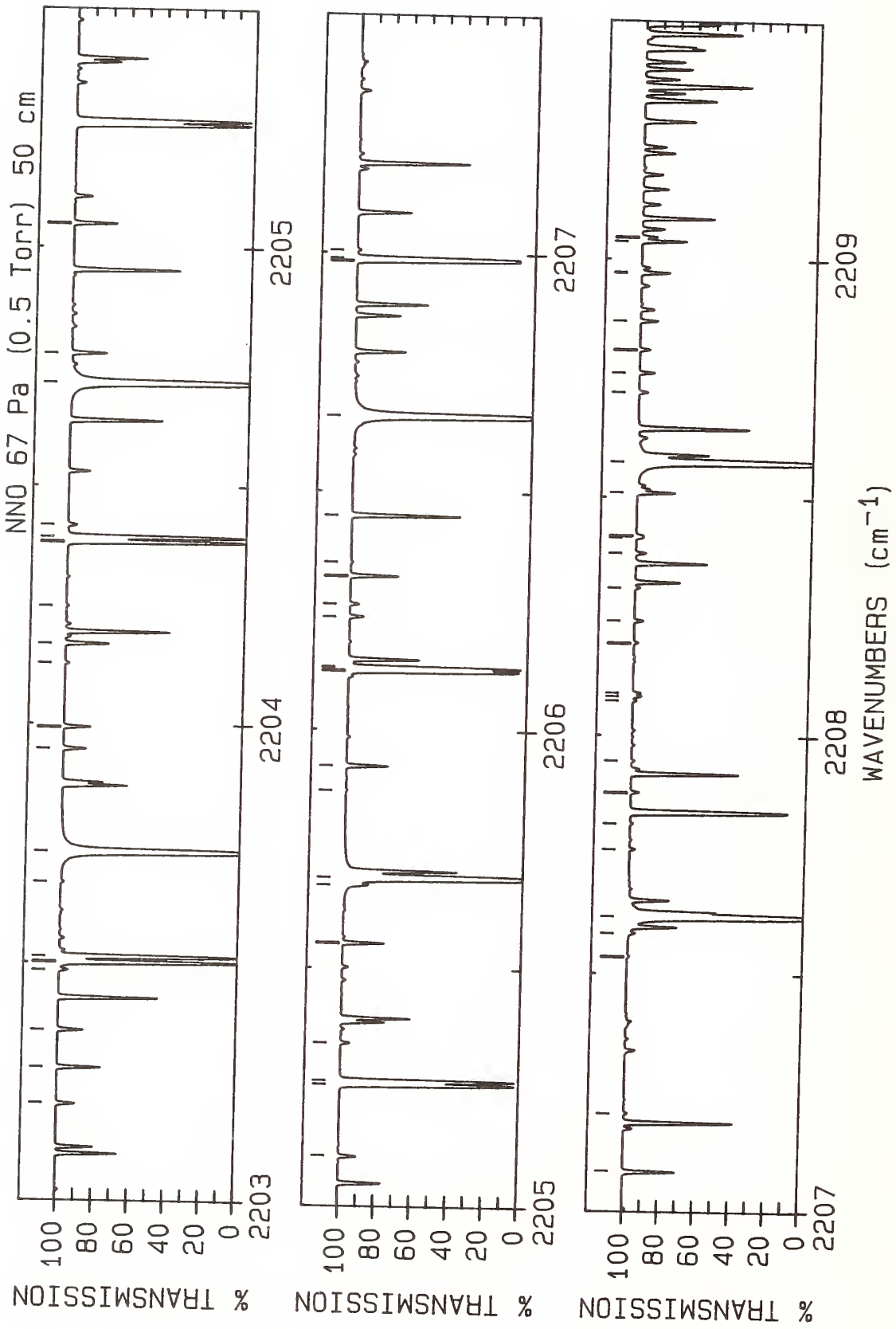

LINE #	WAVENUMBER(unc) (cm ⁻¹)	LOWER STATE (cm ⁻¹)	INTENSITY (cm/molecule)	ASSIGNMENT ROTATION BAND	LINE #	WAVENUMBER(unc) (cm ⁻¹)	LOWER STATE (cm ⁻¹)	INTENSITY (cm/molecule)	ASSIGNMENT ROTATION BAND
1	2203.204 56(4)	0.81	0.689E-21	R(1)	36	2206.351 23(8)*	906.16	0.870E-22	Q(27) C
2	2203.280 77(3)	107.58	0.175E-20	P(16)	37	2206.449 4	1254.20	0.302E-20	R(13) F
3	2203.359 25(3)	527.64	0.969E-21	R(35)	38	2206.450 0	1254.20	0.302E-20	R(13) E
4	2203.484 93(3)	154.51	0.325E-21	P(19)	39	2206.658 76(5)*	159.20	0.856E-18	P(19) A
5	2203.501 66(8)*	612.29	0.342E-19	P(7)	40	2206.984 38(8)*	593.81	0.146E-19	P(3) C
6	2203.513 37(8)*	612.24	0.342E-19	P(7)	41	2206.989 22(8)*	593.80	0.146E-19	P(3) B
7	2203.669 24(18)	2090.84	0.108E-21	R(28)	42	2207.005 91(8)*	840.68	0.134E-21	Q(24) C
8	2203.733 25(5)*	211.97	0.765E-18	P(22)	43	2207.084 87(4)	17.00	0.223E-20	R(6) R
9	2203.948 28(3)	557.77	0.860E-21	R(36)	44	2207.207 37(8)*	820.54	0.154E-21	Q(23) C
10	2203.994 09(4)	2.43	0.103E-20	R(2)	45	2207.536 26(8)*	905.56	0.873E-22	Q(27) B
11	2204.126 84(36)	2157.99	0.827E-22	R(30)	46	2207.585 12(8)*	782.76	0.203E-21	Q(21) C
12	2204.127 21(36)	2157.99	0.827E-22	R(30)	47	2207.620 30(5)*	143.28	0.876E-18	P(18) A
13	2204.168 28(3)	94.93	0.175E-20	P(15)	48	2207.761 41(8)*	765.12	0.232E-21	Q(20) C
14	2204.246 86(54)	2113.94	0.100E-21	R(29)	49	2207.815 09(8)*	861.16	0.117E-21	Q(25) B
15	2204.382 57(8)*	606.41	0.299E-19	P(6)	50	2207.880 91(3)	792.08	0.326E-21	R(43) P
16	2204.392 52(8)*	606.37	0.300E-19	P(6)	51	2207.946 62(8)*	840.21	0.135E-21	Q(24) B
17	2204.417 54(3)	139.06	0.332E-21	P(18)	52	2208.072 87(8)*	820.10	0.155E-21	Q(23) B
18	2204.715 23(5)*	193.54	0.799E-18	P(21)	53	2208.082 03(3)	85.39	0.336E-21	P(14) V
19	2204.776 90(4)	4.86	0.135E-20	R(3)	54	2208.088 84(8)*	732.38	0.301E-21	Q(18) C
20	2205.049 39(3)	83.06	0.173E-20	P(14)	55	2208.193 87(8)*	800.83	0.178E-21	Q(22) B
21	2205.105 94(3)	620.54	0.667E-21	R(38)	56	2208.239 96(8)*	717.26	0.343E-21	Q(17) C
22	2205.256 66(8)*	601.37	0.253E-19	P(5)	57	2208.309 61(8)*	782.39	0.203E-21	Q(21) B
23	2205.264 88(8)*	601.34	0.253E-19	P(5)	58	2208.382 69(8)*	702.99	0.390E-21	Q(16) C
24	2205.343 56(3)	124.43	0.337E-21	P(17)	59	2208.415 44(3)	828.89	0.278E-21	R(44) P
25	2205.552 96(4)	8.10	0.166E-20	R(4)	60	2208.420 08(8)*	764.79	0.232E-21	Q(20) B
26	2205.674 56(3)	653.18	0.583E-21	R(39)	61	2208.509 81(3)	43.51	0.150E-20	P(10) T
27	2205.690 41(5)*	175.95	0.830E-18	P(20)	62	2208.575 01(5)*	128.20	0.891E-18	P(17) A
28	2205.872 86(8)*	954.01	0.643E-22	Q(29)	63	2208.719 92(8)*	717.02	0.344E-21	Q(17) B
29	2205.924 11(3)	71.99	0.169E-20	P(13)	64	2208.760 54(8)*	665.20	0.573E-21	Q(13) C
30	2206.123 93(8)*	597.17	0.202E-19	P(4)	65	2208.809 35(8)*	702.77	0.390E-21	Q(16) B
31	2206.130 45(8)*	597.15	0.202E-19	P(4)	66	2208.869 70(8)*	654.28	0.653E-21	Q(12) C
32	2206.131 5	1349.99	0.178E-20	R(12)	67	2208.970 46(8)*	644.20	0.746E-21	Q(11) C
33	2206.236 37(3)	686.65	0.508E-21	R(40)	68	2208.972 41(8)*	676.79	0.504E-21	Q(14) B
34	2206.262 99(3)	110.60	0.339E-21	P(16)	69	2209.037 5	1398.38	0.184E-20	R(16) D
35	2206.322 29(4)	12.15	0.196E-20	R(5)	70	2209.046 05(8)*	665.05	0.574E-21	Q(13) B

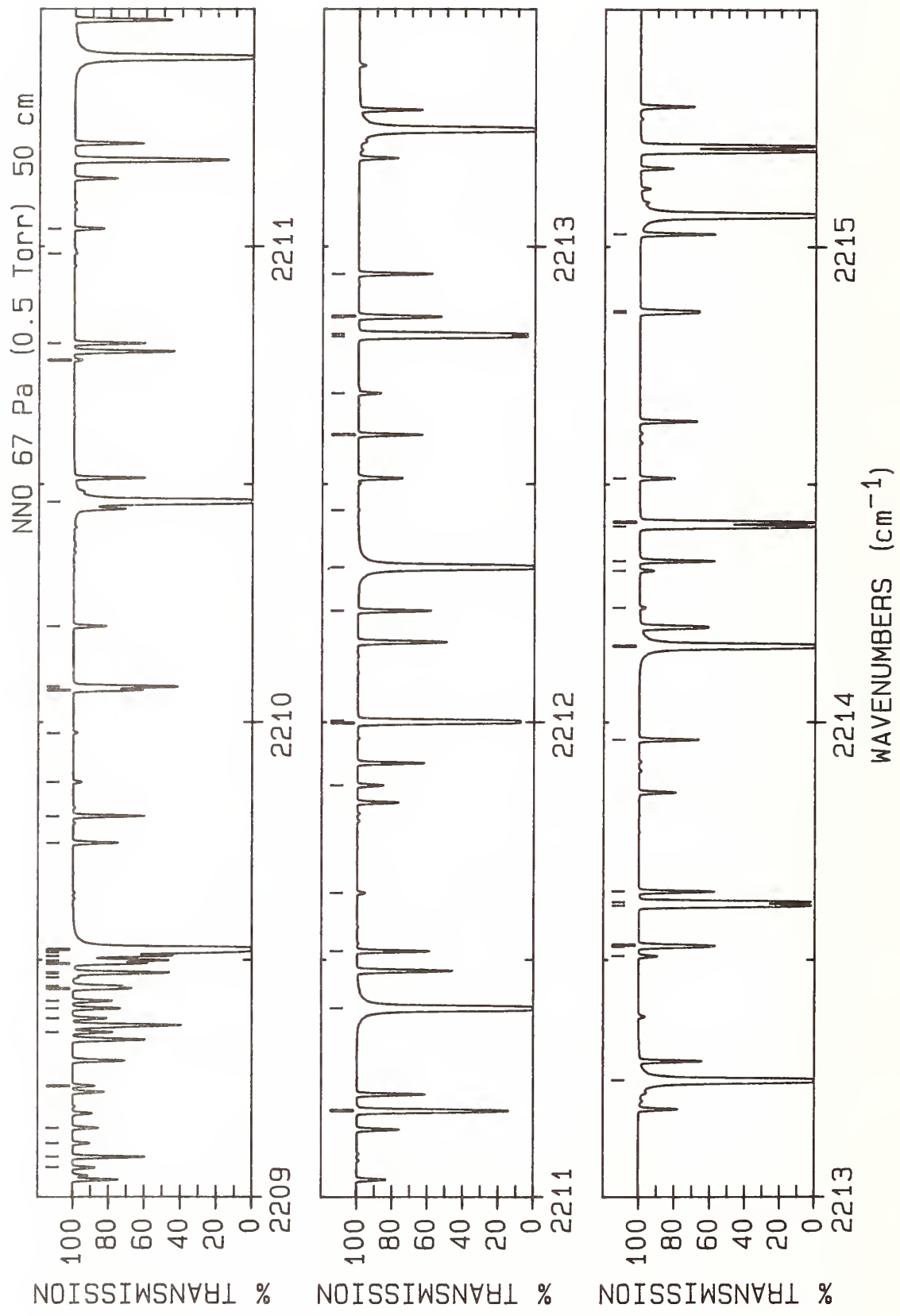

LINE #	WAVENUMBER(unc) (cm ⁻¹)	LOWER STATE (cm ⁻¹)	INTENSITY (cm/molecule)	ASSIGNMENT ROTATION BAND	LINE #	WAVENUMBER(unc) (cm ⁻¹)	LOWER STATE (cm ⁻¹)	INTENSITY (cm/molecule)	ASSIGNMENT ROTATION BAND
1	2209.062 83(8)*	634.96	0.854E-21	Q(10) C	36	2211.398 16(5)*	87.98	0.894E-18	P(14) A
2	2209.085 5	1282.33	0.326E-20	R(16) G	37	2211.518 49(3)	63.15	0.331E-20	R(12) R
3	2209.114 44(8)*	654.15	0.653E-21	Q(12) B	38	2211.640 80(4)	44.73	0.293E-21	P(10) V
4	2209.146 81(8)*	626.56	0.984E-21	Q(9) C	39	2211.867 57(3)	16.61	0.103E-20	P(6) T
5	2209.235 42(8)*	634.88	0.855E-21	Q(10) B	40	2211.998 87(8)*	591.28	0.148E-19	R(2) B
6	2209.348 35(8)*	606.41	0.159E-20	Q(6) C	41	2212.003 45(8)*	591.29	0.148E-19	R(2) C
7	2209.377 43(8)*	612.24	0.134E-20	Q(7) B	42	2212.233 74(3)	73.68	0.339E-20	R(13) R
8	2209.398 74(8)*	601.37	0.193E-20	Q(5) C	43	2212.325 53(5)*	76.25	0.880E-18	P(13) A
9	2209.414 25(8)*	606.37	0.159E-20	Q(6) B	44	2212.445 60(4)	1153.37	0.673E-22	R(52) P
10	2209.440 73(8)*	597.17	0.242E-20	Q(4) C	45	2212.604 2	1362.08	0.286E-20	R(21) G
11	2209.445 81(8)*	601.34	0.193E-20	Q(5) B	46	2212.690 94(3)	11.87	0.875E-21	P(5) T
12	2209.464 02(3)	905.01	0.200E-21	R(46) P	47	2212.809 95(8)*	593.80	0.205E-19	R(3) B
13	2209.472 11(8)*	597.15	0.242E-20	Q(4) B	48	2212.815 99(8)*	593.81	0.205E-19	R(3) C
14	2209.474 32(8)*	593.81	0.319E-20	Q(3) C	49	2212.850 6	1390.28	0.259E-20	R(22) F
15	2209.493 15(8)*	593.80	0.319E-20	Q(3) B	50	2212.853 4	1390.30	0.259E-20	R(22) E
16	2209.499 52(8)*	591.29	0.461E-20	Q(2) C	51	2212.942 22(3)	85.01	0.343E-20	R(14) R
17	2209.508 93(8)*	591.28	0.461E-20	Q(2) B	52	2213.246 05(5)*	65.36	0.857E-18	P(12) A
18	2209.516 31(8)*	589.61	0.837E-20	Q(1) C	53	2213.507 87(4)	7.91	0.714E-21	P(4) T
19	2209.519 45(8)*	589.61	0.837E-20	Q(1) B	54	2213.527 6	1409.60	0.246E-20	R(23) F
20	2209.522 90(5)*	113.96	0.900E-18	P(16) A	55	2213.530 9	1409.62	0.246E-20	R(23) E
21	2209.746 5	1412.57	0.182E-20	R(17) D	56	2213.614 19(8)*	597.15	0.259E-19	R(4) B
22	2209.803 0	1296.61	0.322E-20	R(17) G	57	2213.621 66(8)*	597.17	0.259E-19	R(4) C
23	2209.874 65(4)	63.44	0.321E-21	P(12) V	58	2213.643 92(3)	97.16	0.345E-20	R(15) R
24	2209.978 06(3)	944.33	0.169E-21	R(47) P	59	2213.963 5	1399.85	0.259E-20	R(23) G
25	2210.067 66(3)	44.53	0.307E-20	R(10) R	60	2214.159 73(5)*	55.31	0.825E-18	P(11) A
26	2210.073 9	1321.41	0.298E-20	R(18) F	61	2214.240 34(4)	22.77	0.229E-21	P(7) V
27	2210.075 5	1321.41	0.298E-20	R(18) E	62	2214.318 37(4)	4.75	0.544E-21	P(3) T
28	2210.201 53(3)	28.48	0.129E-20	P(8) T	63	2214.338 84(3)	110.11	0.344E-20	R(16) R
29	2210.463 95(5)*	100.55	0.901E-18	P(15) A	64	2214.411 60(8)*	601.34	0.308E-19	R(5) B
30	2210.761 04(4)	53.68	0.309E-21	P(11) V	65	2214.420 47(8)*	601.37	0.308E-19	R(5) C
31	2210.796 46(3)	53.44	0.320E-20	R(11) R	66	2214.512 9	1535.19	0.139E-20	R(24) D
32	2210.985 61(4)	1025.45	0.119E-21	R(49) P	67	2214.861 2	1450.75	0.218E-20	R(25) F
33	2211.037 76(3)	22.15	0.117E-20	P(7) T	68	2214.865 3	1450.78	0.218E-20	R(25) E
34	2211.180 97(8)*	589.61	0.837E-20	R(1) B	69	2215.026 97(3)	123.87	0.341E-20	R(17) R
35	2211.184 05(8)*	589.61	0.837E-20	R(1) C					

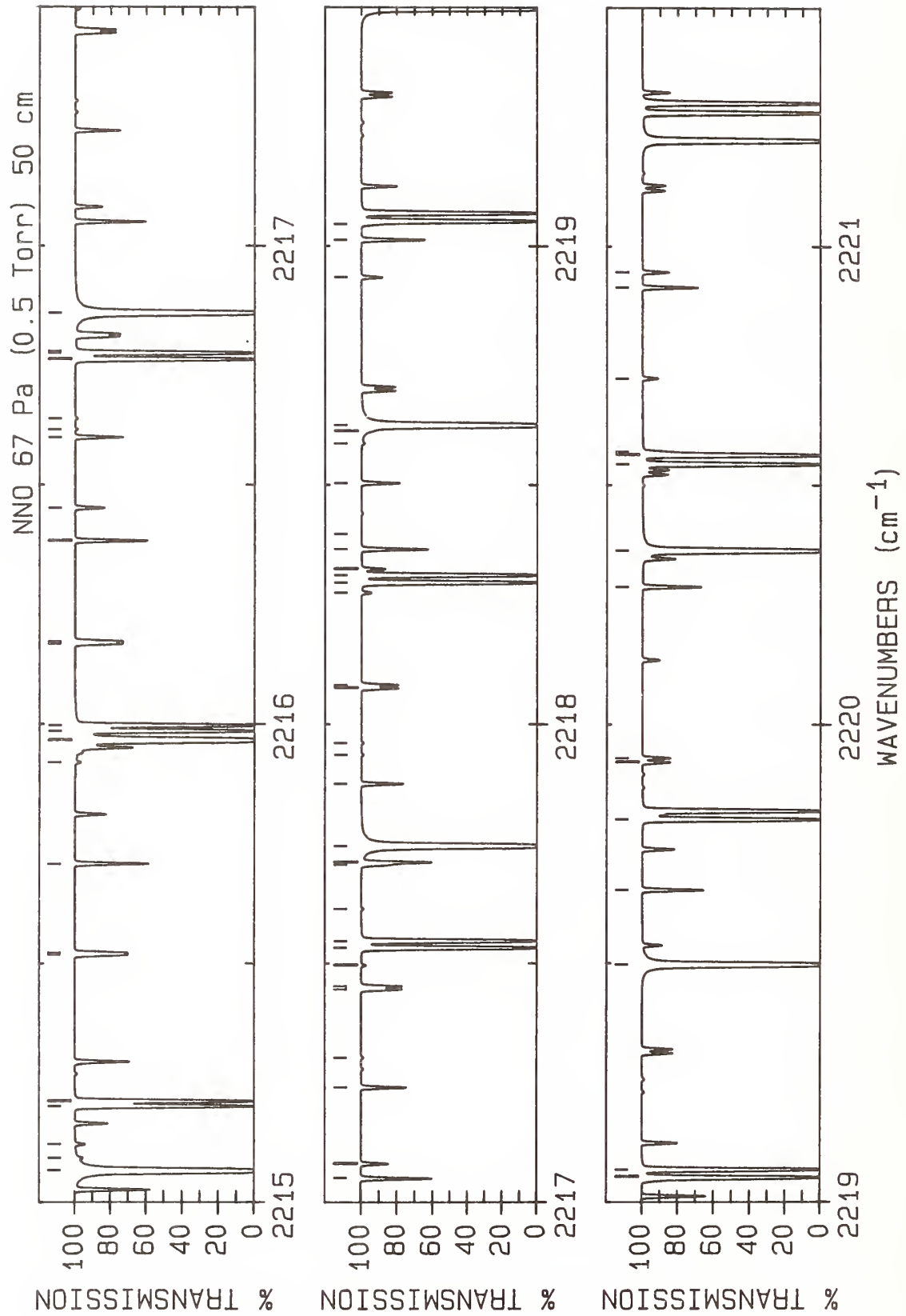

LINE #	WAVENUMBER(unc) (cm ⁻¹)	LOWER STATE (cm ⁻¹)	INTENSITY (cm/molecule)	ASSIGNMENT ROTATION BAND	LINE #	WAVENUMBER(unc) (cm ⁻¹)	LOWER STATE (cm ⁻¹)	INTENSITY (cm/molecule)	ASSIGNMENT ROTATION BAND
1	2215.066 54(5)*	46.09	0.785E-18	P(10)	36	2217.745 81(5)*	23.46	0.614E-18	P(7)
2	2215.093 58(5)	17.08	0.202E-21	P(6)	37	2217.876 0	1533.28	0.169E-20	R(29)
3	2215.122 42(4)	2.37	0.367E-21	P(2)	38	2217.936 1	750.41	0.101E-21	R(20)
4	2215.202 16(8)*	606.37	0.353E-19	R(6)	39	2217.960 8	750.71	0.101E-21	R(20)
5	2215.212 42(8)*	606.41	0.353E-19	R(6)	40	2218.075 1	1568.31	0.147E-20	R(30)
6	2215.517 7	1472.58	0.204E-20	R(26)	41	2218.081 9	1568.36	0.147E-20	R(30)
7	2215.522 3	1472.61	0.204E-20	R(26)	42	2218.274 12(4)	0.79	0.370E-21	R(1)
8	2215.708 31(3)	138.44	0.335E-20	R(18)	43	2218.295 96(8)*	634.88	0.489E-19	R(10)
9	2215.920 02(4)	0.79	0.185E-21	P(1)	44	2218.311 41(8)*	634.96	0.489E-19	R(10)
10	2215.966 50(5)*	37.71	0.736E-18	P(9)	45	2218.323 9	1672.80	0.881E-21	R(30)
11	2215.985 89(8)*	612.24	0.394E-19	R(7)	46	2218.365 69(3)	204.82	0.294E-20	R(22)
12	2215.997 49(8)*	612.29	0.394E-19	R(7)	47	2218.397 9	1498.23	0.112E-22	R(47)
13	2216.167 4	1495.26	0.189E-20	R(27)	48	2218.503 9	1558.45	0.155E-20	R(30)
14	2216.172 5	1495.29	0.189E-20	R(27)	49	2218.586 6	767.03	0.975E-22	R(21)
15	2216.382 86(3)	153.82	0.327E-20	R(19)	50	2218.612 1	767.36	0.974E-22	R(21)
16	2216.451 8	1600.25	0.113E-20	R(27)	51	2218.625 16(5)*	17.60	0.542E-18	P(6)
17	2216.599 5	1485.45	0.199E-20	R(27)	52	2218.934 4	1698.65	0.802E-21	R(31)
18	2216.615 9	719.56	0.106E-21	R(18)	53	2219.013 01(3)	223.43	0.280E-20	R(23)
19	2216.638 6	719.80	0.106E-21	R(18)	54	2219.045 90(4)	2.37	0.551E-21	R(2)
20	2216.762 76(8)*	618.95	0.431E-19	R(8)	55	2219.052 26(8)*	644.10	0.511E-19	R(11)
21	2216.775 68(8)*	619.00	0.431E-19	R(8)	56	2219.068 95(8)*	644.20	0.511E-19	R(11)
22	2216.780 15(5)	8.13	0.141E-21	P(4)	57	2219.497 64(5)*	12.57	0.463E-18	P(5)
23	2216.859 59(5)*	30.17	0.679E-18	P(8)	58	2219.653 53(3)	242.85	0.265E-20	R(24)
24	2217.050 60(3)	170.01	0.318E-20	R(20)	59	2219.801 71(8)*	654.15	0.528E-19	R(12)
25	2217.081 5	1623.60	0.105E-20	R(28)	60	2219.920 9	1648.90	0.109E-20	R(33)
26	2217.241 2	1508.94	0.184E-20	R(28)	61	2219.929 8	1648.97	0.109E-20	R(33)
27	2217.302 9	734.86	0.104E-21	R(19)	62	2220.287 23(3)	263.09	0.250E-20	R(25)
28	2217.446 0	1543.12	0.161E-20	R(29)	63	2220.363 23(5)*	8.38	0.378E-18	P(4)
29	2217.452 3	1543.16	0.161E-20	R(29)	64	2220.544 29(8)*	665.05	0.539E-19	R(13)
30	2217.495 88(4)	0.00	0.186E-21	R(0)	65	2220.563 33(8)*	665.20	0.539E-19	R(13)
31	2217.532 79(8)*	626.49	0.463E-19	R(9)	66	2220.570 05(3)	7.91	0.895E-21	R(4)
32	2217.546 99(8)*	626.56	0.462E-19	R(9)	67	2220.723 4	1781.19	0.586E-21	R(34)
33	2217.613 46(5)	4.88	0.107E-21	P(3)	68	2220.914 11(3)	284.13	0.234E-20	R(26)
34	2217.706 3	1647.79	0.963E-21	R(29)	69	2220.946 1	1667.49	0.103E-20	R(34)
35	2217.711 55(3)	187.01	0.306E-20	R(21)					

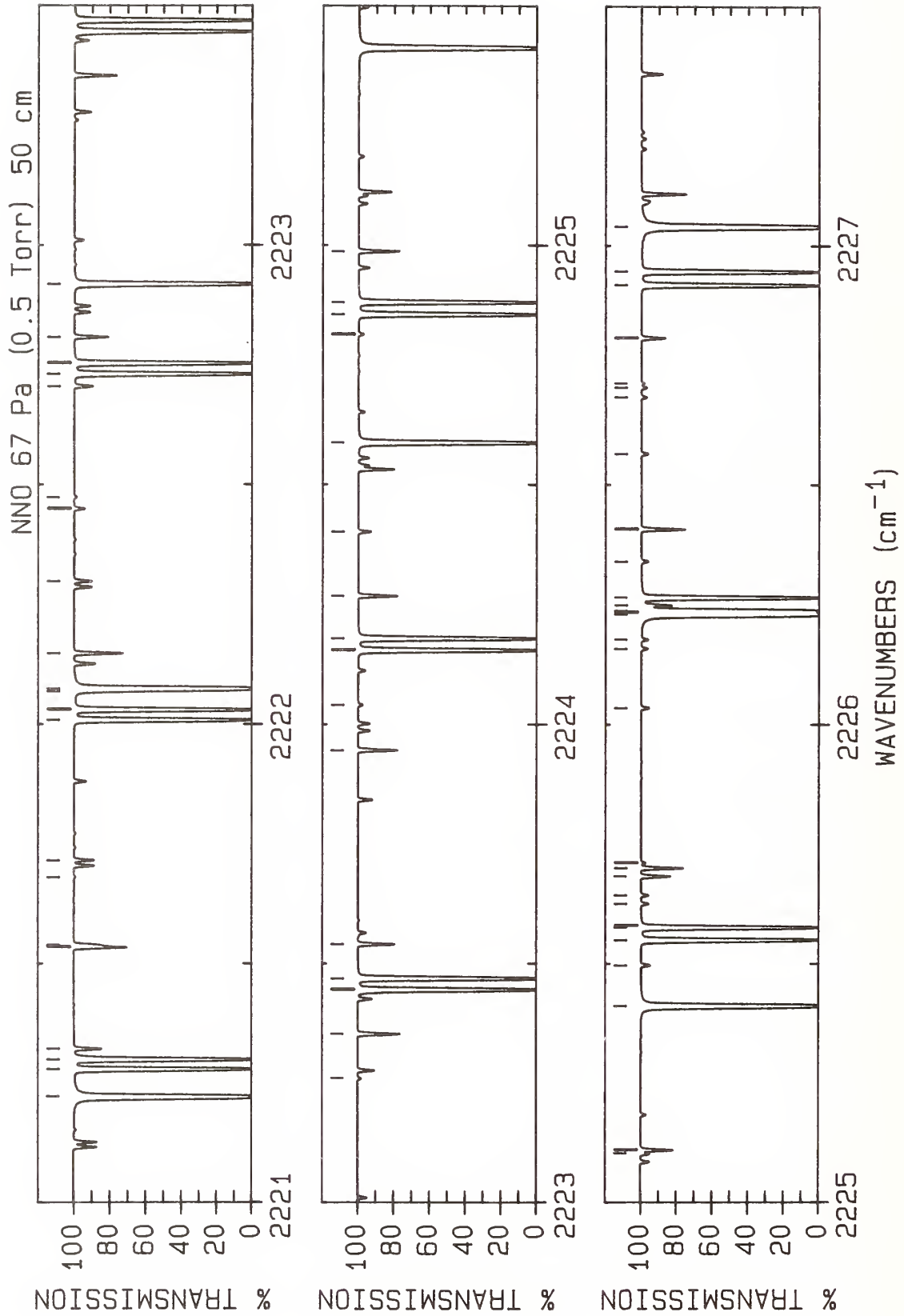

LINE #	WAVENUMBER(unc) (cm ⁻¹)	LOWER STATE (cm ⁻¹)	INTENSITY (cm/molecule)	ASSIGNMENT ROTATION BAND	LINE #	WAVENUMBER(unc) (cm ⁻¹)	LOWER STATE (cm ⁻¹)	INTENSITY (cm/molecule)	ASSIGNMENT ROTATION BAND
1	2221.221 93(5)*	5.03	0.288E-18	P(3) A	36	2224.855 29(8)*	748.03	0.516E-19	R(19) B
2	2221.279 99(8)*	676.79	0.546E-19	R(14) B	37	2224.880 67(8)*	748.33	0.515E-19	R(19) C
3	2221.300 16(8)*	676.95	0.546E-19	R(14) C	38	2224.987 05(3)	43.51	0.166E-20	R(10) T
4	2221.322 42(3)	11.87	0.105E-20	R(5) T	39	2225.102 9	1936.08	0.339E-21	R(42) E
5	2221.534 16(3)	305.98	0.218E-20	R(27) R	40	2225.110 98(3)	454.04	0.129E-20	R(33) R
6	2221.539 3	1696.84	0.914E-21	R(35) G	41	2225.412 02(5)*	0.84	0.196E-18	R(1) A
7	2221.680 15(5)	0.81	0.729E-22	R(1) V	42	2225.497 0	1925.71	0.357E-21	R(42) G
8	2221.716 0	1737.13	0.770E-21	R(36) E	43	2225.549 68(8)*	764.79	0.499E-19	R(20) B
9	2222.008 82(8)*	689.36	0.548E-19	R(15) B	44	2225.576 01(8)*	765.12	0.498E-19	R(20) C
10	2222.030 10(8)*	689.55	0.548E-19	R(15) C	45	2225.580 04(4)	17.08	0.236E-21	R(6) V
11	2222.068 32(3)	16.61	0.120E-20	R(6) T	46	2225.625 5	1971.97	0.291E-21	R(43) F
12	2222.073 75(5)*	2.51	0.195E-18	P(2) A	47	2225.643 2	1972.17	0.291E-21	R(43) E
13	2222.147 39(3)	328.64	0.202E-20	R(28) R	48	2225.683 16(3)	481.55	0.116E-20	R(34) R
14	2222.297 7	1768.20	0.680E-21	R(37) E	49	2225.700 50(3)	52.21	0.173E-20	R(11) T
15	2222.449 2	1871.22	0.410E-21	R(37) D	50	2225.711 5	2073.73	0.177E-21	R(43) D
16	2222.473 49(5)	2.44	0.109E-21	R(2) V	51	2226.034 5	1961.75	0.307E-21	R(43) G
17	2222.704 9	1758.06	0.716E-21	R(37) G	52	2226.157 9	2008.88	0.249E-21	R(44) F
18	2222.730 77(8)*	702.77	0.546E-19	R(16) B	53	2226.176 7	2009.10	0.249E-21	R(44) E
19	2222.753 11(8)*	702.99	0.546E-19	R(16) C	54	2226.229 32(5)*	2.51	0.292E-18	R(2) A
20	2222.753 78(3)	352.10	0.187E-20	R(29) R	55	2226.233 7	2110.39	0.151E-21	R(44) D
21	2222.807 73(3)	22.15	0.134E-20	R(7) T	56	2226.237 17(8)*	782.39	0.480E-19	R(21) B
22	2222.918 67(5)*	0.84	0.981E-19	P(1) A	57	2226.248 49(3)	509.86	0.104E-20	R(35) R
23	2223.260 15(5)	4.88	0.143E-21	R(3) V	58	2226.264 41(8)*	782.76	0.479E-19	R(21) C
24	2223.353 34(3)	376.38	0.171E-20	R(30) R	59	2226.339 96(4)	22.77	0.262E-21	R(7) V
25	2223.445 83(8)*	717.02	0.540E-19	R(17) B	60	2226.407 45(3)	61.71	0.179E-20	R(12) T
26	2223.469 22(8)*	717.26	0.539E-19	R(17) C	61	2226.565 1	1998.62	0.262E-21	R(44) G
27	2223.540 66(3)	28.48	0.146E-20	R(8) T	62	2226.683 4	2046.63	0.212E-21	R(45) F
28	2223.946 06(3)	401.46	0.157E-20	R(31) R	63	2226.703 3	2046.86	0.211E-21	R(45) E
29	2224.040 14(5)	8.13	0.176E-21	R(4) V	64	2226.712 1	2147.88	0.129E-21	R(45) D
30	2224.154 01(8)*	732.11	0.529E-19	R(18) B	65	2226.806 97(3)	538.98	0.925E-21	R(36) R
31	2224.178 41(8)*	732.38	0.529E-19	R(18) C	66	2226.917 75(8)*	800.83	0.459E-19	R(22) B
32	2224.267 10(3)	35.60	0.156E-20	R(9) T	67	2226.945 88(8)*	801.23	0.458E-19	R(22) C
33	2224.401 1	1856.14	0.479E-21	R(40) G	68	2227.039 70(5)*	5.03	0.385E-18	R(3) A
34	2224.587 81(5)*	0.00	0.985E-19	R(0) A					
35	2224.813 43(4)	12.20	0.207E-21	R(5) V					

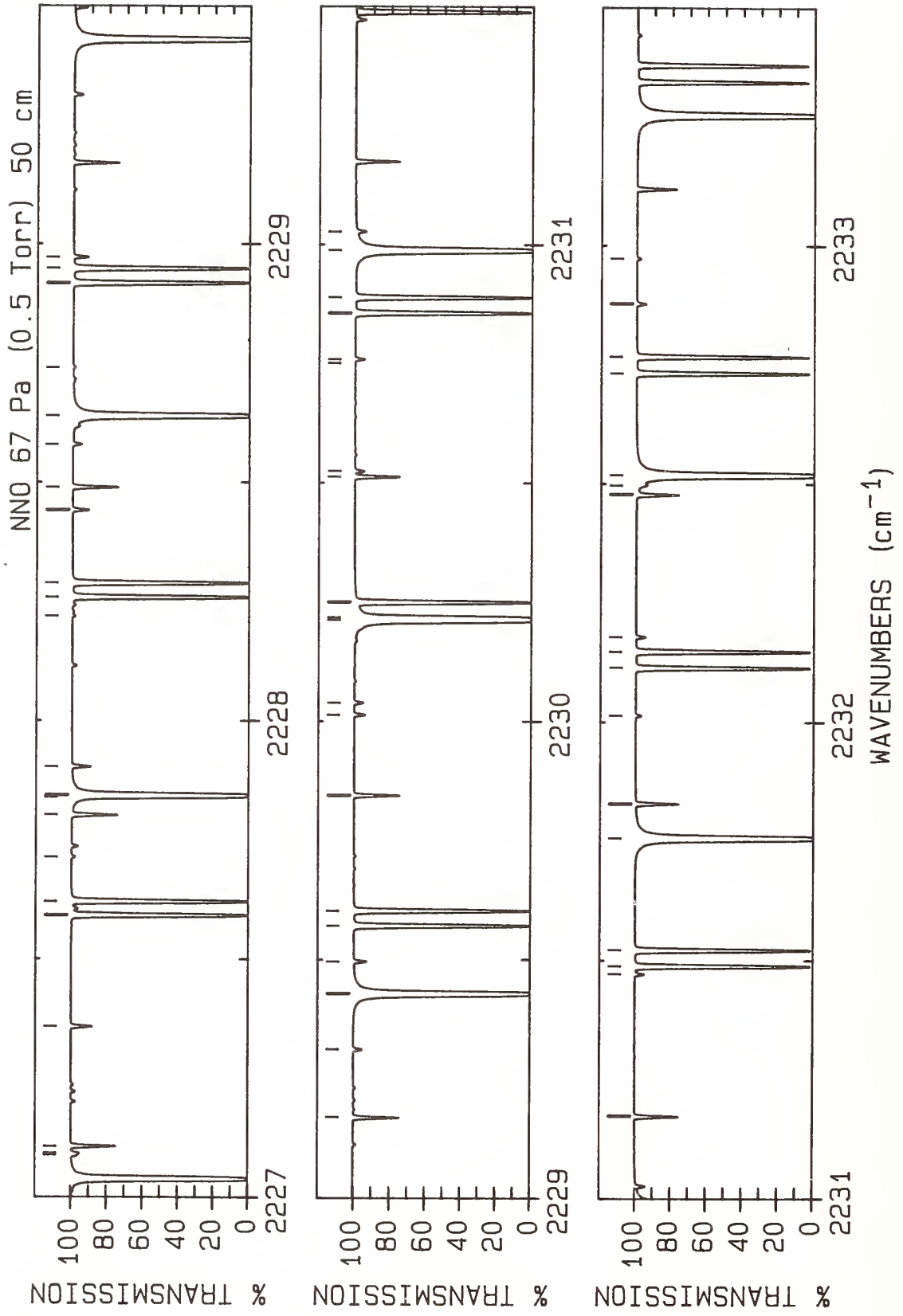

LINE #	WAVENUMBER(unc) (cm ⁻¹)	LOWER STATE (cm ⁻¹)	INTENSITY (cm/molecule)	ASSIGNMENT ROTATION BAND	LINE #	WAVENUMBER(unc) (cm ⁻¹)	LOWER STATE (cm ⁻¹)	INTENSITY (cm/molecule)	ASSIGNMENT ROTATION BAND
1	2227.088 7	2036.33	0.223E-21	R(45) G	36	2230.512 48(2)	135.27	0.183E-20	R(18) T
2	2227.093 18(4)	29.28	0.286E-21	R(8) V	37	2230.524 07(3)	765.40	0.364E-21	R(43) R
3	2227.107 90(3)	71.99	0.183E-20	R(13) T	38	2230.750 7	1298.44	0.143E-22	R(42) Y
4	2227.358 59(3)	568.91	0.821E-21	R(37) R	39	2230.758 71(3)	74.01	0.358E-21	R(13) V
5	2227.591 43(8)*	820.10	0.436E-19	R(23) B	40	2230.856 07(8)*	929.02	0.310E-19	R(28) B
6	2227.620 41(8)*	820.54	0.435E-19	R(23) C	41	2230.888 85(8)*	929.66	0.309E-19	R(28) C
7	2227.713 6	2124.63	0.151E-21	R(47) F	42	2230.987 74(5)*	30.17	0.767E-18	R(8) A
8	2227.801 84(3)	83.06	0.186E-20	R(14) T	43	2231.026 2	2367.97	0.518E-22	R(53) G
9	2227.839 70(4)	36.60	0.307E-21	R(9) V	44	2231.027 58(3)	800.98	0.313E-21	R(44) R
10	2227.843 17(5)*	8.38	0.473E-18	R(4) A	45	2231.173 83(2)	150.30	0.179E-20	R(19) T
11	2227.903 34(3)	599.64	0.725E-21	R(38) R	46	2231.471 67(3)	85.39	0.363E-21	R(14) V
12	2228.218 3	2164.88	0.126E-21	R(48) F	47	2231.488 22(8)*	953.32	0.285E-19	R(29) B
13	2228.258 19(8)*	840.21	0.412E-19	R(24) B	48	2231.521 66(8)*	954.01	0.284E-19	R(29) C
14	2228.288 00(8)*	840.68	0.411E-19	R(24) C	49	2231.756 55(5)*	37.71	0.821E-18	R(9) A
15	2228.441 23(3)	631.18	0.638E-21	R(39) R	50	2231.828 66(2)	166.12	0.174E-20	R(20) T
16	2228.489 28(3)	94.93	0.188E-20	R(15) T	51	2232.013 94(3)	874.54	0.228E-21	R(46) R
17	2228.579 52(4)	44.73	0.324E-21	R(10) V	52	2232.113 44(8)*	978.45	0.260E-19	R(30) B
18	2228.639 71(5)*	12.57	0.557E-18	R(5) A	53	2232.147 51(8)*	979.18	0.259E-19	R(30) C
19	2228.740 4	2206.29	0.106E-21	R(49) E	54	2232.177 91(3)	97.59	0.365E-21	R(15) V
20	2228.918 04(8)*	861.16	0.387E-19	R(25) B	55	2232.476 96(2)	182.72	0.168E-20	R(21) T
21	2228.948 64(8)*	861.67	0.386E-19	R(25) C	56	2232.496 79(4)	912.53	0.194E-21	R(47) R
22	2228.972 25(3)	663.53	0.558E-21	R(40) R	57	2232.518 41(5)*	46.09	0.868E-18	R(10) A
23	2229.170 20(2)	107.58	0.187E-20	R(16) T	58	2232.731 72(8)*	1004.42	0.237E-19	R(31) B
24	2229.312 63(3)	53.68	0.339E-21	R(11) V	59	2232.766 39(8)*	1005.20	0.236E-19	R(31) C
25	2229.429 32(5)*	17.60	0.634E-18	R(6) A	60	2232.877 42(3)	110.60	0.364E-21	R(16) V
26	2229.496 40(3)	696.68	0.486E-21	R(41) R	61	2232.972 74(4)	951.32	0.164E-21	R(48) R
27	2229.570 98(8)*	882.94	0.361E-19	R(26) B					
28	2229.602 0	2237.36	0.926E-22	R(50) G					
29	2229.602 33(8)*	883.50	0.360E-19	R(26) C					
30	2229.844 60(2)	121.03	0.186E-20	R(17) T					
31	2230.013 67(3)	730.64	0.422E-21	R(42) R					
32	2230.039 03(3)	63.44	0.350E-21	R(12) V					
33	2230.212 00(5)*	23.46	0.704E-18	R(7) A					
34	2230.216 99(8)*	905.56	0.335E-19	R(27) B					
35	2230.249 07(8)*	906.16	0.334E-19	R(27) C					

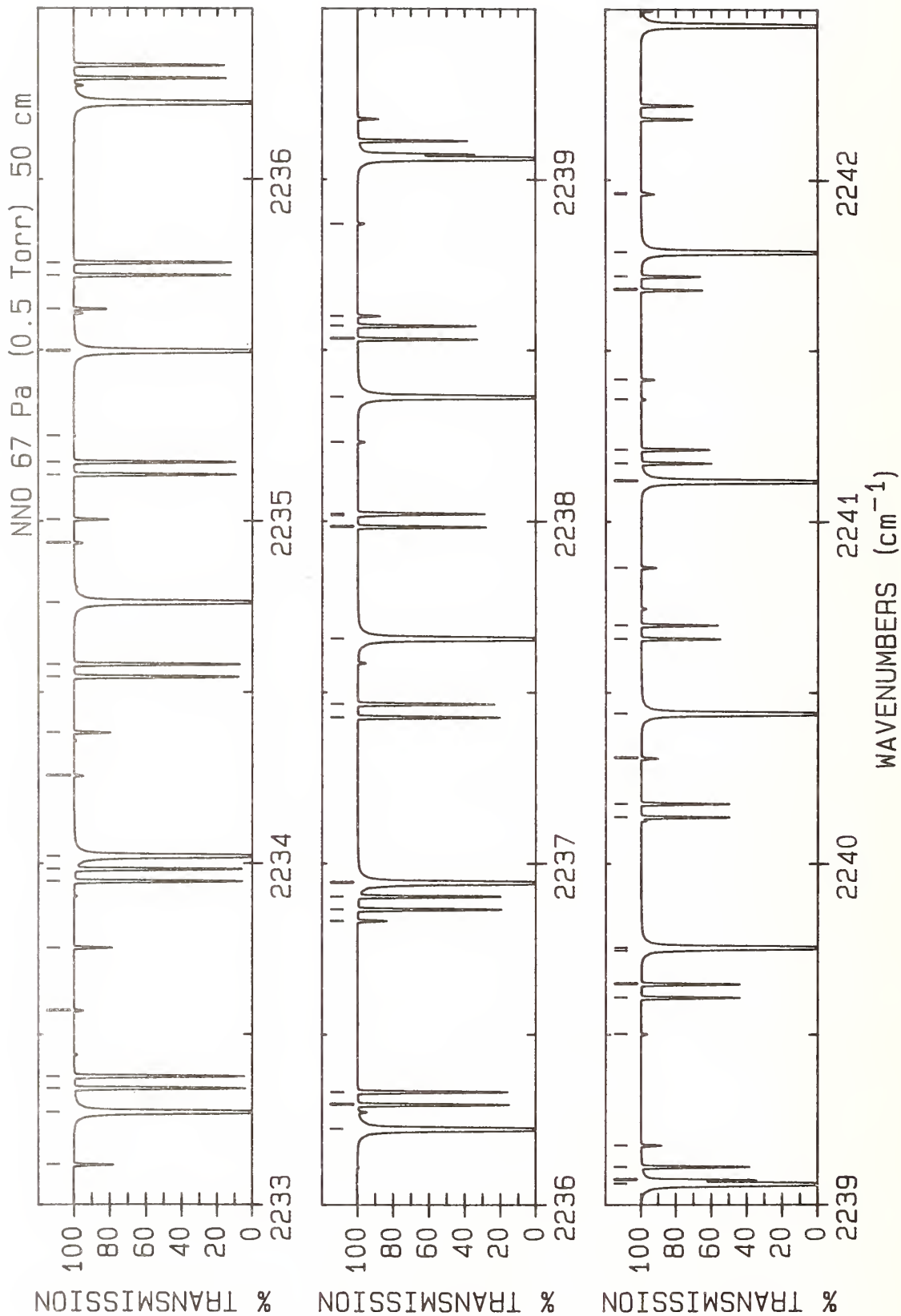

LINE #	WAVENUMBER(unc) (cm ⁻¹)	LOWER STATE (cm ⁻¹)	INTENSITY (cm/molecule)	ASSIGNMENT ROTATION BAND	LINE #	WAVENUMBER(unc) (cm ⁻¹)	LOWER STATE (cm ⁻¹)	INTENSITY (cm/molecule)	ASSIGNMENT ROTATION BAND
1	2233.118 72(2)	200.12	0.161E-20	R(22) T	36	2238.017 10(3)	367.75	0.960E-21	R(30) T
2	2233.273 32(5)*	55.31	0.905E-18	R(11) A	37	2238.021 98(8)*	1277.04	0.802E-20	R(40) C
3	2233.343 06(8)*	1031.22	0.214E-19	R(32) B	38	2238.230 85(3)	243.94	0.279E-21	R(24) V
4	2233.378 29(8)*	1032.06	0.213E-19	R(32) C	39	2238.362 80(5)*	143.28	0.934E-18	R(18) A
5	2233.570 20(3)	124.43	0.360E-21	R(17) V	40	2238.532 16(8)*	1310.06	0.699E-20	R(41) B
6	2233.753 94(2)	218.31	0.154E-20	R(23) T	41	2238.570 95(8)*	1311.42	0.695E-20	R(41) C
7	2233.947 45(8)*	1058.86	0.193E-19	R(33) B	42	2238.599 88(3)	392.26	0.879E-21	R(31) T
8	2233.983 21(8)*	1059.75	0.192E-19	R(33) C	43	2238.869 64(3)	264.27	0.263E-21	R(25) V
9	2234.021 28(5)*	65.36	0.934E-18	R(12) A	44	2239.061 98(5)*	159.20	0.909E-18	R(19) A
10	2234.256 25(3)	139.06	0.354E-21	R(18) V	45	2239.073 89(8)*	1345.22	0.603E-20	R(42) B
11	2234.382 62(2)	237.29	0.146E-20	R(24) T	46	2239.112 90(8)*	1346.65	0.599E-20	R(42) C
12	2234.544 90(8)*	1087.34	0.173E-19	R(34) B	47	2239.176 09(3)	417.55	0.802E-21	R(32) T
13	2234.581 16(8)*	1088.28	0.172E-19	R(34) C	48	2239.501 66(3)	285.40	0.246E-21	R(26) V
14	2234.762 28(5)*	76.25	0.953E-18	R(13) A	49	2239.608 64(8)*	1381.21	0.518E-20	R(43) B
15	2234.935 55(3)	154.51	0.345E-21	R(19) V	50	2239.647 83(8)*	1382.71	0.514E-20	R(43) C
16	2235.004 75(2)	257.06	0.138E-20	R(25) T	51	2239.745 73(3)	443.64	0.727E-21	R(33) T
17	2235.135 39(8)*	1116.65	0.154E-19	R(35) B	52	2239.754 17(5)*	175.95	0.880E-18	R(20) A
18	2235.172 11(8)*	1117.64	0.153E-19	R(35) C	53	2240.136 40(8)*	1418.04	0.442E-20	R(44) B
19	2235.248 98(5)	1157.36	0.659E-22	R(53) R	54	2240.175 75(8)*	1419.61	0.439E-20	R(44) C
20	2235.496 32(5)*	87.98	0.965E-18	R(14) A	55	2240.308 79(3)	470.51	0.657E-21	R(34) T
21	2235.620 33(3)	277.62	0.130E-20	R(26) T	56	2240.439 38(5)*	193.54	0.846E-18	R(21) A
22	2235.718 93(8)*	1146.80	0.137E-19	R(36) B	57	2240.657 18(8)*	1455.70	0.376E-20	R(45) B
23	2235.756 08(8)*	1147.85	0.136E-19	R(36) C	58	2240.696 64(8)*	1457.34	0.373E-20	R(45) C
24	2236.223 39(5)*	100.55	0.968E-18	R(15) A	59	2240.865 27(3)	498.18	0.590E-21	R(35) T
25	2236.295 51(8)*	1177.78	0.121E-19	R(37) B	60	2241.117 59(5)*	211.97	0.809E-18	R(22) A
26	2236.333 06(8)*	1178.89	0.120E-19	R(37) C	61	2241.170 96(8)*	1494.20	0.319E-20	R(46) B
27	2236.831 83(3)	321.11	0.113E-20	R(28) T	62	2241.210 51(8)*	1495.90	0.316E-20	R(46) C
28	2236.865 13(8)*	1209.60	0.106E-19	R(38) B	63	2241.357 11(4)	353.68	0.196E-21	R(29) V
29	2236.903 03(8)*	1210.77	0.105E-19	R(38) C	64	2241.415 16(3)	526.63	0.528E-21	R(36) T
30	2236.943 50(5)*	113.96	0.964E-18	R(16) A	65	2241.677 76(8)*	1533.53	0.268E-20	R(47) B
31	2237.427 75(3)	344.03	0.104E-20	R(29) T	66	2241.717 35(8)*	1535.31	0.266E-20	R(47) C
32	2237.427 78(8)*	1242.25	0.927E-20	R(39) B	67	2241.788 81(5)*	231.24	0.768E-18	R(23) A
33	2237.466 01(8)*	1243.48	0.922E-20	R(39) C	68	2241.958 47(3)	555.87	0.470E-21	R(37) T
34	2237.656 64(5)*	128.20	0.952E-18	R(17) A	69	2241.962 03(4)	378.06	0.180E-21	R(30) V
35	2237.983 46(8)*	1275.74	0.807E-20	R(40) B					

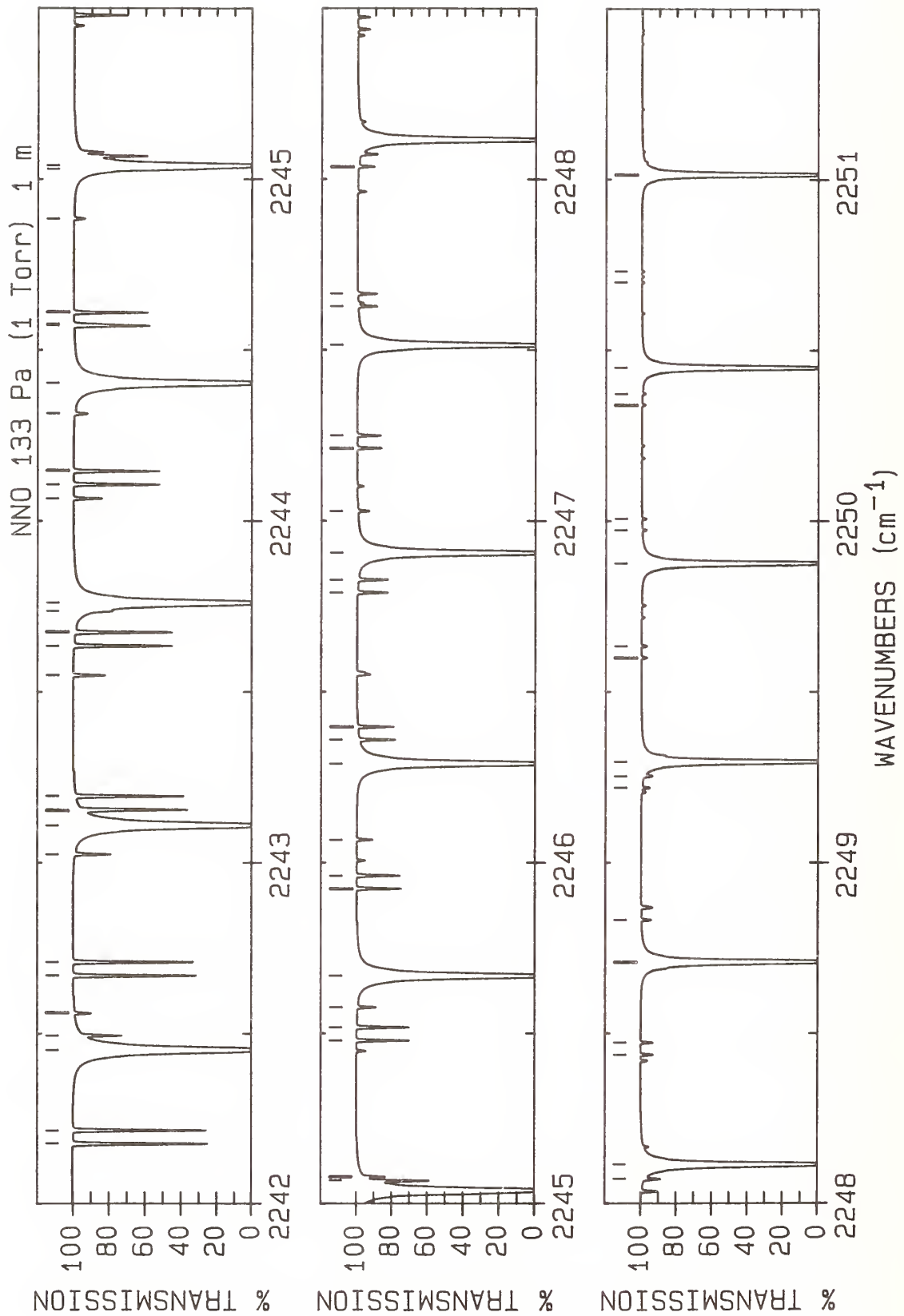

LINE #	WAVENUMBER(cm^{-1})	LOWER STATE (cm^{-1})	INTENSITY ($\text{cm}/\text{molecule}$)	ASSIGNMENT ROTATION BAND	LINE #	WAVENUMBER(unc) (cm^{-1})	LOWER STATE (cm^{-1})	INTENSITY ($\text{cm}/\text{molecule}$)	ASSIGNMENT ROTATION BAND
1	2242.177 55(8)*	1573.69	0.225E-20	R(48) B	36	2245.961 92(8)*	1927.48	0.466E-21	R(56) C
2	2242.217 15(8)*	1575.55	0.223E-20	R(48) C	37	2246.067 40(3)	818.17	0.158E-21	R(45) T
3	2242.453 03(5)*	251.34	0.725E-18	R(24) A	38	2246.291 12(5)*	389.53	0.458E-18	R(30) A
4	2242.495 19(3)	585.90	0.416E-21	R(38) T	39	2246.360 27(8)*	1972.62	0.380E-21	R(57) B
5	2242.560 17(4)	403.25	0.164E-21	R(31) V	40	2246.398 26(8)*	1975.23	0.375E-21	R(57) C
6	2242.670 34(8)*	1614.68	0.188E-20	R(49) B	41	2246.789 91(8)*	2021.11	0.305E-21	R(58) B
7	2242.709 91(8)*	1616.62	0.186E-20	R(49) C	42	2246.827 53(8)*	2023.80	0.301E-21	R(58) C
8	2243.025 32(3)	616.72	0.367E-21	R(39) T	43	2246.906 23(5)*	415.49	0.417E-18	R(31) A
9	2243.110 24(5)*	272.28	0.681E-18	R(25) A	44	2247.028 53(3)	891.62	0.115E-21	R(47) T
10	2243.151 53(4)	429.26	0.149E-21	R(32) V	45	2247.212 51(8)*	2070.42	0.244E-21	R(59) B
11	2243.156 13(8)*	1656.51	0.156E-20	R(50) B	46	2247.249 73(8)*	2073.21	0.241E-21	R(59) C
12	2243.195 64(8)*	1658.53	0.155E-20	R(50) C	47	2247.514 31(5)*	442.28	0.377E-18	R(32) A
13	2243.548 84(3)	648.32	0.323E-21	R(40) T	48	2247.628 08(8)*	2120.57	0.194E-21	R(60) B
14	2243.634 91(8)*	1699.17	0.130E-20	R(51) B	49	2247.664 85(8)*	2123.45	0.191E-21	R(60) C
15	2243.674 32(8)*	1701.27	0.128E-20	R(51) C	50	2248.036 61(8)*	2171.55	0.154E-21	R(61) B
16	2243.736 09(4)	456.08	0.135E-21	R(33) V	51	2248.072 89(8)*	2174.53	0.152E-21	R(61) C
17	2243.760 45(5)*	294.06	0.636E-18	R(26) A	52	2248.115 36(5)*	469.91	0.340E-18	R(33) A
18	2244.065 77(3)	680.72	0.282E-21	R(41) T	53	2248.438 10(8)*	2223.36	0.121E-21	R(62) B
19	2244.106 68(8)*	1742.67	0.107E-20	R(52) B	54	2248.473 85(8)*	2226.43	0.120E-21	R(62) C
20	2244.145 95(8)*	1744.84	0.106E-20	R(52) C	55	2248.709 37(5)*	498.37	0.304E-18	R(34) A
21	2244.313 86(4)	483.70	0.121E-21	R(34) V	56	2248.832 54(8)*	2275.99	0.953E-22	R(63) B
22	2244.403 64(5)*	316.67	0.591E-18	R(27) A	57	2249.219 94(8)*	2329.46	0.746E-22	R(64) B
23	2244.571 44(8)*	1786.99	0.876E-21	R(53) B	58	2249.254 50(8)*	2332.74	0.734E-22	R(64) C
24	2244.576 09(3)	713.90	0.246E-21	R(42) T	59	2249.296 34(5)*	527.67	0.271E-18	R(35) A
25	2244.610 53(8)*	1789.25	0.867E-21	R(53) C	60	2249.600 28(8)*	2383.76	0.581E-22	R(65) B
26	2244.884 83(4)	512.14	0.109E-21	R(35) V	61	2249.634 19(8)*	2387.14	0.571E-22	R(65) C
27	2245.029 18(8)*	1832.15	0.716E-21	R(54) B	62	2249.876 26(5)*	557.81	0.241E-18	R(36) A
28	2245.039 82(5)*	340.12	0.546E-18	R(28) A	63	2249.973 57(8)*	2438.88	0.450E-22	R(66) B
29	2245.068 05(8)*	1834.50	0.708E-21	R(54) C	64	2250.006 79(8)*	2442.37	0.443E-22	R(66) C
30	2245.079 81(3)	747.87	0.213E-21	R(43) T	65	2250.339 80(8)*	2494.84	0.348E-22	R(67) B
31	2245.479 90(8)*	1878.14	0.582E-21	R(55) B	66	2250.372 28(8)*	2498.43	0.342E-22	R(67) C
32	2245.518 52(8)*	1880.57	0.575E-21	R(55) C	67	2250.449 13(5)*	588.78	0.213E-18	R(37) A
33	2245.576 91(3)	782.62	0.184E-21	R(44) T	68	2250.698 98(8)*	2551.62	0.267E-22	R(68) B
34	2245.668 98(5)*	364.41	0.501E-18	R(29) A	69	2250.730 67(8)*	2555.32	0.263E-22	R(68) C
35	2245.923 60(8)*	1924.97	0.472E-21	R(56) B	70	2251.014 96(5)*	620.59	0.187E-18	R(38) A

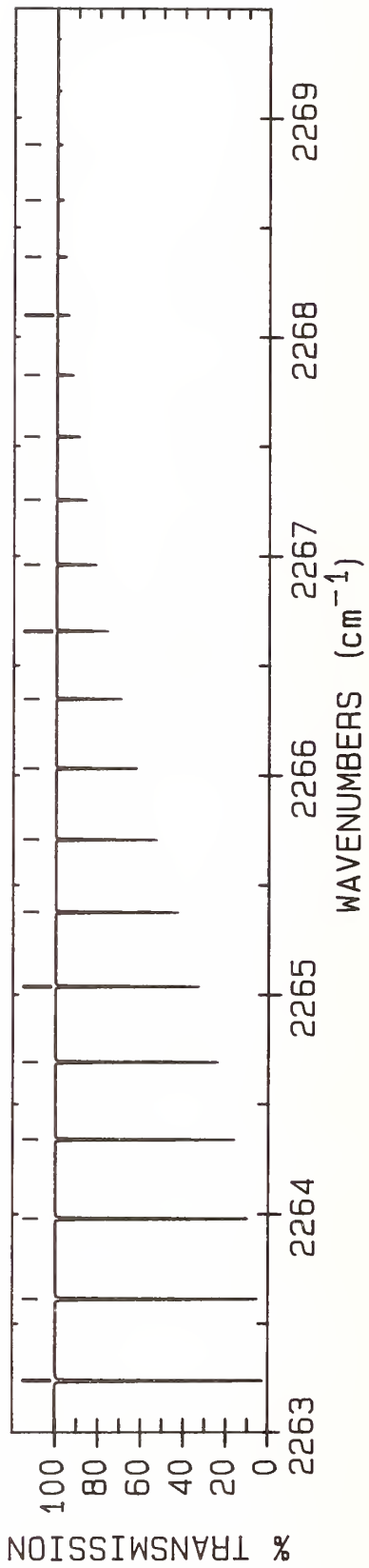
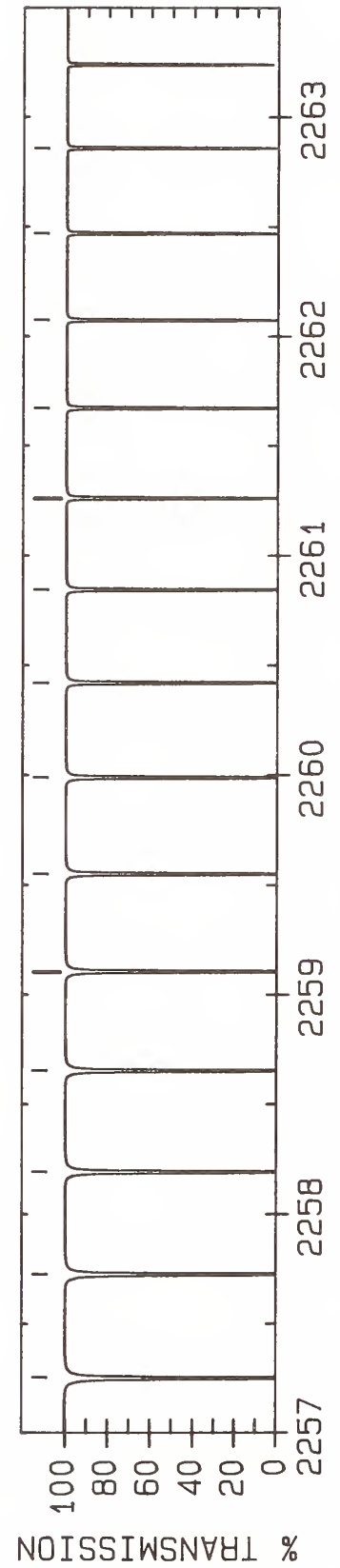
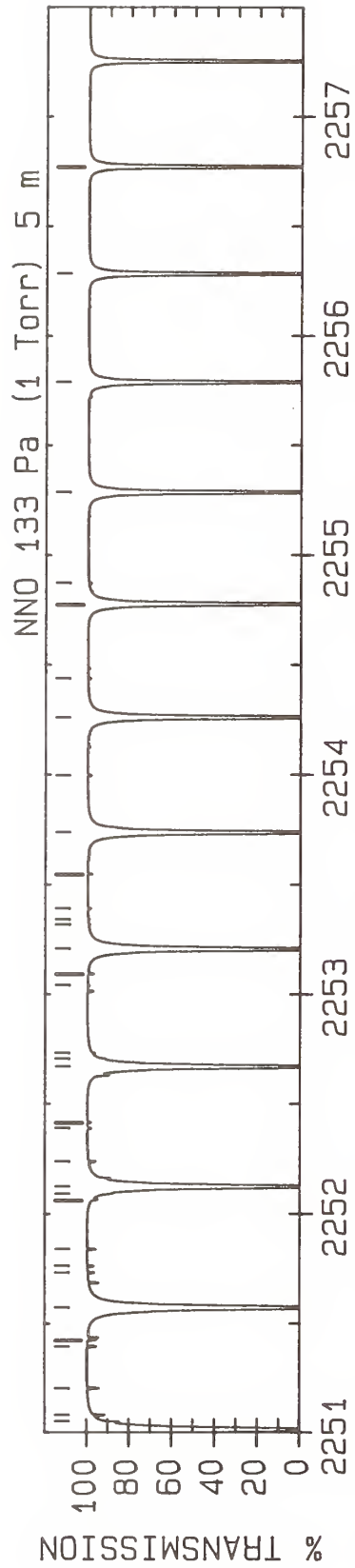

LINE #	WAVENUMBER(unc) (cm ⁻¹)	LOWER STATE (cm ⁻¹)	INTENSITY (cm/molecule)	ASSIGNMENT ROTATION BAND	LINE #	WAVENUMBER(unc) (cm ⁻¹)	LOWER STATE (cm ⁻¹)	INTENSITY (cm/molecule)	ASSIGNMENT ROTATION BAND
1	2251.051 09(8)*	2609.24	0.205E-22	R(69)	36	2257.253 42(5)*	1067.33	0.276E-19	R(50)
2	2251.081 96(8)*	2613.04	0.201E-22	R(69)	37	2257.727 24(5)*	1109.98	0.228E-19	R(51)
3	2251.205 20(5)	916.61	0.201E-22	R(47)	38	2258.193 95(5)*	1153.46	0.188E-19	R(52)
4	2251.396 13(8)*	2667.68	0.156E-22	R(70)	39	2258.653 56(5)*	1197.77	0.154E-19	R(53)
5	2251.426 14(8)*	2671.59	0.153E-22	R(70)	40	2259.106 06(5)*	1242.91	0.126E-19	R(54)
6	2251.573 72(5)*	653.23	0.163E-18	R(39)	41	2259.551 45(5)*	1288.88	0.103E-19	R(55)
7	2251.734 10(8)*	2726.94	0.119E-22	R(71)	42	2259.989 73(5)*	1335.69	0.831E-20	R(56)
8	2251.763 21(8)*	2730.97	0.116E-22	R(71)	43	2260.420 88(5)*	1383.33	0.670E-20	R(57)
9	2251.840 53(4)	1351.81	0.149E-22	R(58)	44	2260.844 92(5)*	1431.79	0.538E-20	R(58)
10	2252.065 01(9)*	2787.04	0.896E-23	R(72)	45	2261.261 83(5)*	1481.09	0.430E-20	R(59)
11	2252.093 16(8)*	2791.17	0.878E-23	R(72)	46	2261.671 60(5)*	1531.22	0.342E-20	R(60)
12	2252.125 43(5)*	686.70	0.142E-18	R(40)	47	2262.074 25(5)*	1582.18	0.271E-20	R(61)
13	2252.238 10(5)	1398.36	0.121E-22	R(59)	48	2262.469 77(5)*	1633.97	0.214E-20	R(62)
14	2252.388 84(9)*	2847.96	0.674E-23	R(73)	49	2262.858 14(5)*	1686.59	0.168E-20	R(63)
15	2252.415 99(8)*	2852.21	0.660E-23	R(73)	50	2263.239 38(5)*	1740.04	0.131E-20	R(64)
16	2252.670 07(5)*	721.01	0.123E-18	R(41)	51	2263.613 47(5)*	1794.32	0.102E-20	R(65)
17	2252.705 59(9)*	2909.71	0.505E-23	R(74)	52	2263.980 41(5)*	1849.42	0.795E-21	R(66)
18	2252.731 70(9)*	2914.07	0.495E-23	R(74)	53	2264.340 20(5)*	1905.36	0.614E-21	R(67)
19	2253.040 28(9)*	2976.77	0.369E-23	R(75)	54	2264.692 84(5)*	1962.12	0.472E-21	R(68)
20	2253.093 52(6)	1077.32	0.993E-23	R(51)	55	2265.038 32(5)*	2019.71	0.361E-21	R(69)
21	2253.207 65(5)*	756.16	0.106E-18	R(42)	56	2265.376 64(5)*	2078.13	0.275E-21	R(70)
22	2253.317 85(9)*	3035.69	0.280E-23	R(76)	57	2265.707 80(5)*	2137.38	0.209E-21	R(71)
23	2253.341 74(9)*	3040.29	0.274E-23	R(76)	58	2266.031 79(5)*	2197.45	0.158E-21	R(72)
24	2253.390 86(5)	1542.71	0.628E-23	R(62)	59	2266.348 61(5)*	2258.36	0.119E-21	R(73)
25	2253.548 50(6)	1119.52	0.824E-23	R(52)	60	2266.658 26(5)*	2320.08	0.892E-22	R(74)
26	2253.738 15(5)*	792.14	0.912E-19	R(43)	61	2266.960 74(5)*	2382.64	0.666E-22	R(75)
27	2253.996 63(6)	1162.53	0.680E-23	R(53)	62	2267.256 03(5)*	2446.02	0.495E-22	R(76)
28	2254.261 58(5)*	828.95	0.779E-19	R(44)	63	2267.544 15(5)*	2510.22	0.366E-22	R(77)
29	2254.437 92(6)	1206.35	0.559E-23	R(54)	64	2267.825 08(5)*	2575.26	0.270E-22	R(78)
30	2254.777 94(5)*	866.60	0.663E-19	R(45)	65	2268.098 83(5)*	2641.11	0.198E-22	R(79)
31	2254.872 37(7)	1250.97	0.458E-23	R(55)	66	2268.365 38(5)*	2707.79	0.145E-22	R(80)
32	2255.287 21(5)*	905.08	0.561E-19	R(46)	67	2268.624 74(5)*	2775.30	0.106E-22	R(81)
33	2255.789 40(5)*	944.39	0.473E-19	R(47)	68	2268.876 91(5)*	2843.63	0.765E-23	R(82)
34	2256.284 50(5)*	984.54	0.397E-19	R(48)					
35	2256.772 51(5)*	1025.52	0.332E-19	R(49)					

ATLAS OF N₂O ABSORPTION LINES FROM 2400 cm⁻¹ to 2520 cm⁻¹

key:

Band	Isotopomer	Vibrational Transition
a	¹⁴ N ¹⁴ N ¹⁶ O	02 ⁰ 1-00 ⁰ 0
x		02 ^{2e} 1-00 ⁰ 0
b		03 ¹ 1-01 ^{1e} 0
c		03 ¹ 1-01 ^{1f} 0
d		02 ⁰ 2-00 ⁰ 1
e		04 ² 1-02 ^{2e} 0
f		04 ² 1-02 ^{2f} 0
g		04 ⁰ 1-02 ⁰ 0
p	¹⁴ N ¹⁵ N ¹⁶ O	02 ⁰ 1-00 ⁰ 0
r	¹⁵ N ¹⁴ N ¹⁶ O	02 ⁰ 1-00 ⁰ 0
t	¹⁴ N ¹⁴ N ¹⁸ O	02 ⁰ 1-00 ⁰ 0
v	¹⁴ N ¹⁴ N ¹⁷ O	02 ⁰ 1-00 ⁰ 0

If the e or f designation is not specified (for $l \neq 0$), then the transition is to either level, depending on the selection rules and the change in the rotational quantum number, J . Spectra are given for a slitwidth of 0.002 cm⁻¹ and a temperature of 296 K. For all bands, except the x band, the Herman-Wallis constant $\xi_2 = 0.3 \times 10^{-4}$ was used. For the a band a transition moment of 0.017 debye was used, for the b and c bands 0.0155 debye, for the d band 0.024 debye, for the e, f, and g bands 0.014 debye, for the p band 0.013, for r 0.021, for t 0.030, and for v 0.023 debye. In the case of the x band a Herman-Wallis constant of $C_2 = 0.0007$ was used along with the intensity given by the normal l -type doubling intensity borrowed from the a band.

ATLAS OF N₂O ABSORPTION LINES FROM 2450 cm⁻¹ to 2607 cm⁻¹

key:

Band	Isotopomer	Vibrational Transition
A	¹⁴ N ¹⁴ N ¹⁶ O	00 ⁰ 2-00 ⁰ 0
B		01 ¹ 2-01 ^{1e} 0
C		01 ¹ 2-01 ^{1f} 0
D		00 ⁰ 3-00 ⁰ 1
E		02 ² 2-02 ^{2e} 0
F		02 ² 2-02 ^{2f} 0
G		02 ⁰ 2-02 ⁰ 0
P	¹⁴ N ¹⁵ N ¹⁶ O	00 ⁰ 2-00 ⁰ 0
R	¹⁵ N ¹⁴ N ¹⁶ O	00 ⁰ 2-00 ⁰ 0
T	¹⁴ N ¹⁴ N ¹⁸ O	00 ⁰ 2-00 ⁰ 0
V	¹⁴ N ¹⁴ N ¹⁷ O	00 ⁰ 2-00 ⁰ 0

If the e or f designation is not specified (for $l \neq 0$), then the transition is to either level, depending on the selection rules and the change in the rotational quantum number, J . Spectra are given for a slitwidth of 0.002 cm⁻¹ and a transition moment of about 0.037 debye at a temperature of 296 K. No Herman-Wallis constants were used in the calculations. For the T and V bands respectively, transition moments of 0.042 and 0.0395 debye were used.

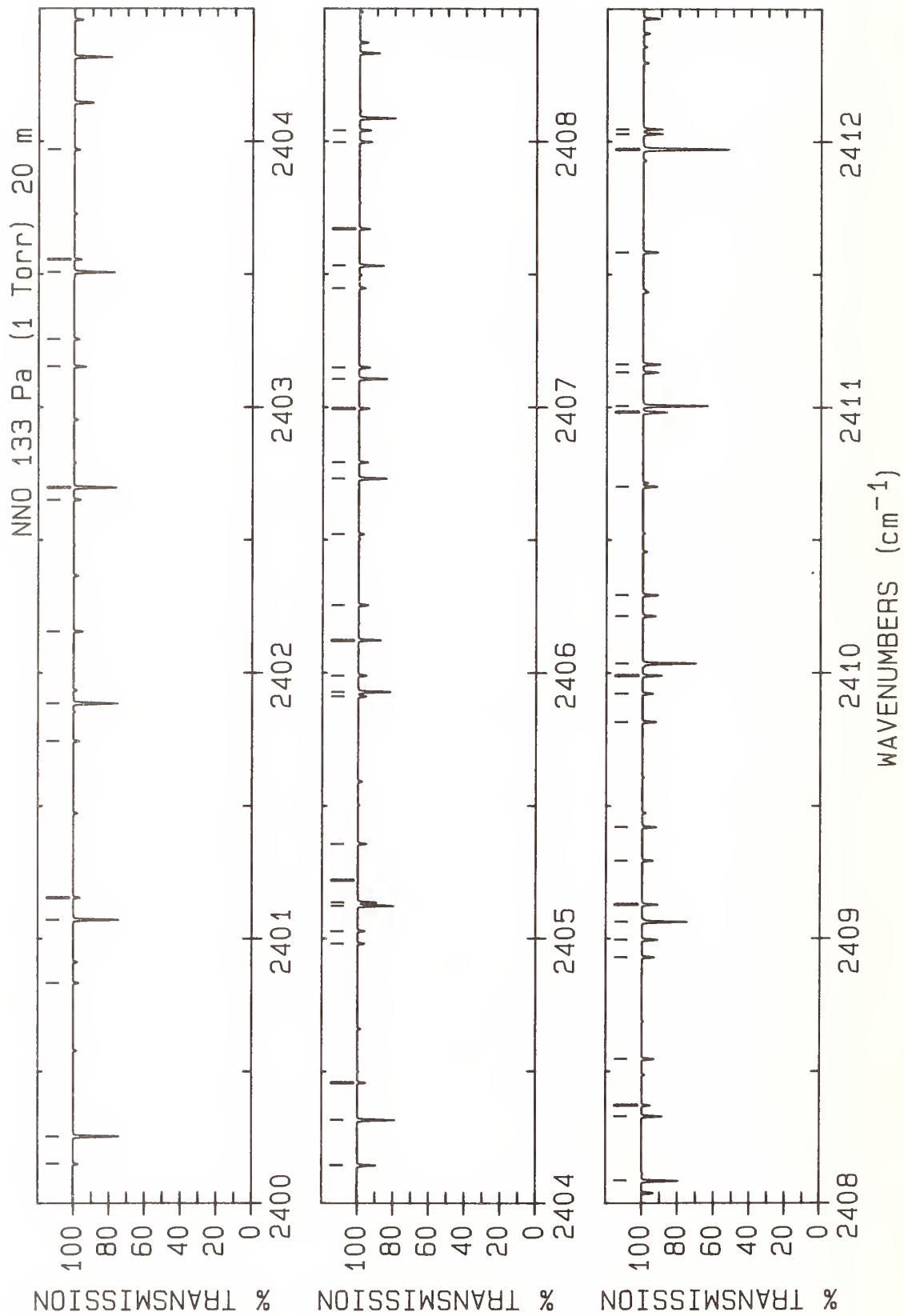

LINE #	WAVENUMBER(unc) (cm ⁻¹)	LOWER STATE (cm ⁻¹)	INTENSITY (cm/molecule)	ASSIGNMENT ROTATION BAND	LINE #	WAVENUMBER(unc) (cm ⁻¹)	LOWER STATE (cm ⁻¹)	INTENSITY (cm/molecule)	ASSIGNMENT ROTATION BAND
1	2400.150 61(16)*	1962.12	0.311E-23	P(68) a	36	2407.106 28(11)*	1582.18	0.172E-22	P(61) a
2	2400.255 0	83.06	0.288E-22	P(14) t	37	2407.148 8	340.10	0.620E-23	P(28) p
3	2400.834 1	527.64	0.319E-23	P(35) p	38	2407.447 87(92)	1975.23	0.396E-23	P(57) c
4	2401.071 4	71.99	0.282E-22	P(13) t	39	2407.532 1	11.87	0.144E-22	P(5) t
5	2401.154 82(14)*	1905.36	0.402E-23	P(67) a	40	2407.670 7	599.64	0.628E-23	P(38) r
6	2401.744 3	498.34	0.356E-23	P(34) p	41	2407.996 86(62)	1832.15	0.742E-23	P(54) b
7	2401.885 8	61.71	0.273E-22	P(12) t	42	2408.040 6	316.65	0.668E-23	P(27) p
8	2402.155 48(13)*	1849.42	0.517E-23	P(66) a	43	2408.086 13(11)*	1531.22	0.215E-22	P(60) a
9	2402.651 7	469.88	0.395E-23	P(33) p	44	2408.331 0	7.91	0.118E-22	P(4) t
10	2402.698 2	52.21	0.262E-22	P(11) t	45	2408.372 08(82)	1927.48	0.489E-23	P(56) c
11	2403.152 60(13)*	1794.32	0.663E-23	P(65) a	46	2408.546 7	568.91	0.707E-23	P(37) r
12	2403.153 5	2565.26	0.280E-24	P(57) e	47	2408.930 0	294.04	0.716E-23	P(26) p
13	2403.256 0	765.40	0.324E-23	P(43) r	48	2408.995 20(56)	1786.99	0.903E-23	P(53) b
14	2403.508 7	43.51	0.248E-22	P(10) t	49	2409.062 61(11)*	1481.09	0.269E-22	P(59) a
15	2403.556 4	442.25	0.437E-23	P(32) p	50	2409.127 9	4.75	0.895E-23	P(3) t
16	2403.969 24(97)	2021.11	0.325E-23	P(58) b	51	2409.294 07(74)	1880.57	0.600E-23	P(55) c
17	2404.143 6	730.64	0.373E-23	P(42) r	52	2409.420 6	538.98	0.793E-23	P(36) r
18	2404.146 22(12)*	1740.04	0.846E-23	P(64) a	53	2409.817 0	272.26	0.763E-23	P(25) p
19	2404.317 3	35.60	0.232E-22	P(9) t	54	2409.923 0	2.37	0.604E-23	P(2) t
20	2404.458 4	415.46	0.480E-23	P(31) p	55	2409.990 15(52)	1742.67	0.109E-22	P(52) b
21	2404.981 32(86)	1972.62	0.402E-23	P(57) b	56	2410.035 75(11)*	1431.79	0.335E-22	P(58) a
22	2405.028 9	696.68	0.428E-23	P(41) r	57	2410.213 86(66)	1834.50	0.733E-23	P(54) c
23	2405.123 9	28.48	0.213E-22	P(8) t	58	2410.292 2	509.86	0.885E-23	P(35) r
24	2405.136 35(12)*	1686.59	0.108E-22	P(63) a	59	2410.701 6	251.32	0.809E-23	P(24) p
25	2405.221 1	2423.92	0.512E-24	P(54) f	60	2410.981 72(48)	1699.17	0.132E-22	P(51) b
26	2405.357 8	389.50	0.526E-23	P(30) p	61	2411.005 58(11)*	1383.33	0.415E-22	P(57) a
27	2405.911 8	663.53	0.489E-23	P(40) r	62	2411.131 51(60)	1789.25	0.892E-23	P(53) c
28	2405.928 6	22.15	0.192E-22	P(7) t	63	2411.161 7	481.55	0.983E-23	P(34) r
29	2405.989 94(77)	1924.97	0.496E-23	P(56) b	64	2411.583 9	231.22	0.853E-23	P(23) p
30	2406.123 03(11)*	1633.97	0.136E-22	P(62) a	65	2411.969 94(46)	1656.51	0.158E-22	P(50) b
31	2406.254 6	364.38	0.572E-23	P(29) p	66	2411.972 14(11)*	1335.69	0.512E-22	P(56) a
32	2406.521 4	2023.80	0.320E-23	P(58) c	67	2412.029 1	454.04	0.109E-22	P(33) r
33	2406.731 3	16.61	0.169E-22	P(6) t	68	2412.047 04(55)	1744.84	0.108E-22	P(52) c
34	2406.792 4	631.18	0.555E-23	P(39) r					
35	2406.995 12(68)	1878.14	0.608E-23	P(55) b					

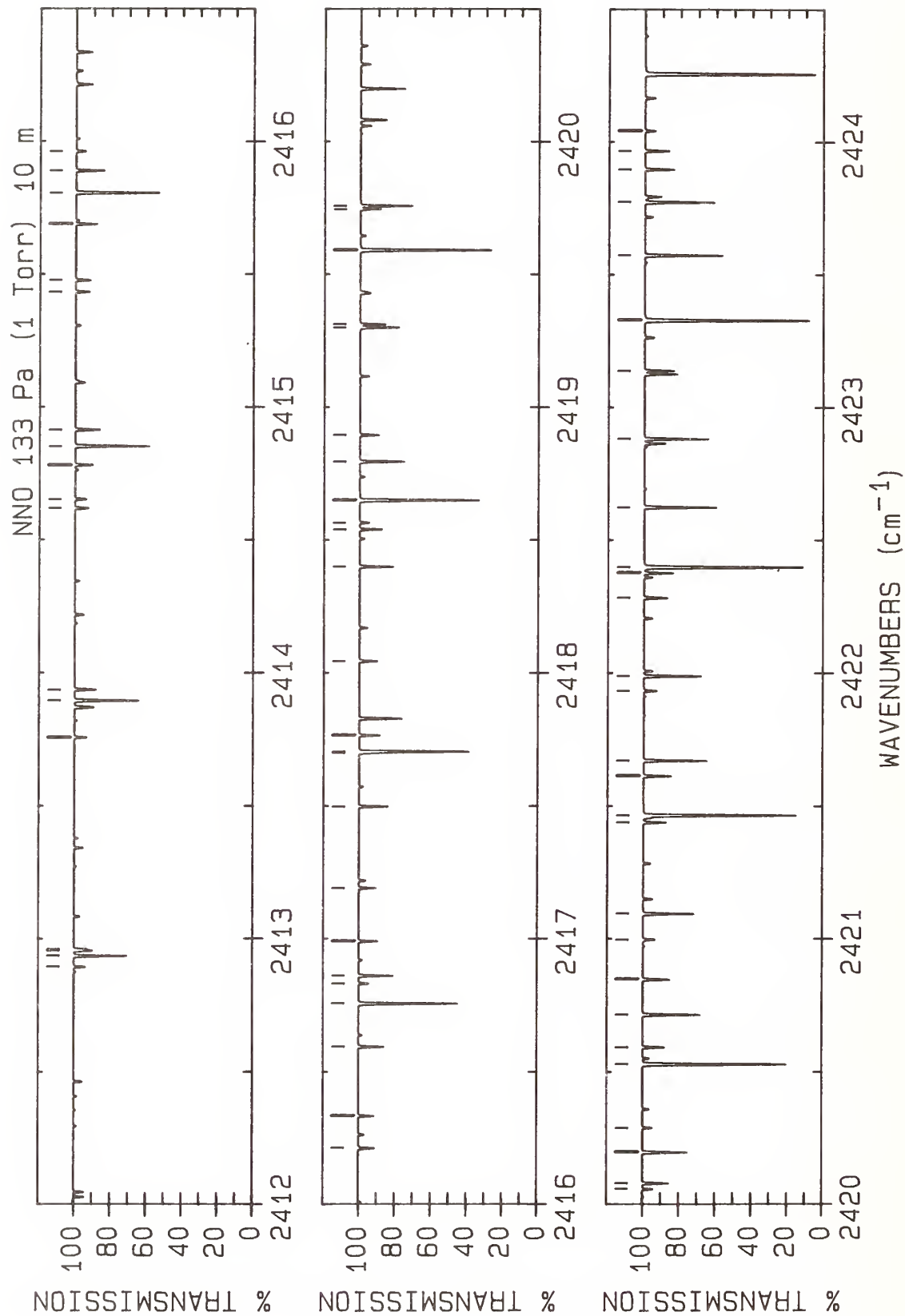

LINE #	WAVENUMBER(unc) (cm ⁻¹)	LOWER STATE (cm ⁻¹)	INTENSITY (cm/molecule)	ASSIGNMENT ROTATION BAND	LINE #	WAVENUMBER(unc) (cm ⁻¹)	LOWER STATE (cm ⁻¹)	INTENSITY (cm/molecule)	ASSIGNMENT ROTATION BAND
1	2412.894 4	427.35	0.119E-22	P(32) r	36	2418.794 95(44)	1381.21	0.502E-22	P(43) b
2	2412.935 46(11)*	1288.88	0.628E-22	P(55) a	37	2418.895 4	263.09	0.203E-22	P(25) r
3	2412.954 81(44)	1614.68	0.189E-22	P(49) b	38	2419.299 57(43)	1419.61	0.428E-22	P(44) c
4	2412.960 49(51)	1701.27	0.130E-22	P(51) c	39	2419.311 0	35.60	0.259E-22	R(9) t
5	2413.757 6	401.46	0.131E-22	P(31) r	40	2419.590 89(11)*	984.54	0.234E-21	P(48) a
6	2413.895 57(11)*	1242.91	0.768E-22	P(54) a	41	2419.745 0	242.85	0.215E-22	P(24) r
7	2413.936 37(44)	1573.69	0.225E-22	P(48) b	42	2419.756 95(44)	1345.22	0.582E-22	P(42) b
8	2414.618 8	376.38	0.143E-22	P(30) r	43	2420.058 49(15)	1758.06	0.110E-22	P(37) g
9	2414.652 4	4.75	0.120E-22	R(3) t	44	2420.080 4	43.51	0.275E-22	R(10) t
10	2414.781 32(46)	1616.62	0.187E-22	P(49) c	45	2420.197 70(44)	1382.71	0.498E-22	P(43) c
11	2414.852 51(11)*	1197.77	0.935E-22	P(53) a	46	2420.290 0	76.25	0.101E-22	P(13) p
12	2414.914 62(43)	1533.53	0.266E-22	P(47) b	47	2420.529 57(11)*	944.39	0.278E-21	P(47) a
13	2415.433 8	7.91	0.147E-22	R(4) t	48	2420.592 8	223.43	0.226E-22	P(23) r
14	2415.478 0	352.10	0.155E-22	P(29) r	49	2420.715 75(44)	1310.06	0.671E-22	P(41) b
15	2415.688 76(44)	1575.55	0.223E-22	P(48) c	50	2420.847 8	52.21	0.288E-22	R(11) t
16	2415.806 31(11)*	1153.46	0.113E-21	P(52) a	51	2420.997 65(14)	1727.03	0.124E-22	P(36) g
17	2415.889 59(43)	1494.20	0.314E-22	P(46) b	52	2421.094 06(44)	1346.65	0.578E-22	P(42) c
18	2415.962 7	143.27	0.101E-22	P(18) p	53	2421.438 8	204.82	0.236E-22	P(22) r
19	2416.213 2	11.87	0.174E-22	R(5) t	54	2421.465 35(11)*	905.08	0.328E-21	P(46) a
20	2416.335 2	328.64	0.167E-22	P(28) r	55	2421.613 0	61.71	0.299E-22	R(12) t
21	2416.594 27(43)	1535.31	0.264E-22	P(47) c	56	2421.671 37(44)	1275.74	0.770E-22	P(40) b
22	2416.757 01(11)*	1109.98	0.137E-21	P(51) a	57	2421.933 19(14)	1696.84	0.139E-22	P(35) g
23	2416.832 1	128.19	0.103E-22	P(17) p	58	2421.988 68(44)	1311.42	0.667E-22	P(41) c
24	2416.861 29(43)	1455.70	0.369E-22	P(45) b	59	2422.283 0	187.01	0.245E-22	P(21) r
25	2416.990 7	16.61	0.198E-22	R(6) t	60	2422.376 2	71.99	0.306E-22	R(13) t
26	2417.190 5	305.98	0.179E-22	P(27) r	61	2422.398 25(11)*	866.60	0.385E-21	P(45) a
27	2417.497 89(43)	1495.90	0.312E-22	P(46) c	62	2422.623 82(44)	1242.25	0.880E-22	P(39) b
28	2417.699 6	113.95	0.103E-22	P(16) p	63	2422.881 60(44)	1277.04	0.766E-22	P(40) c
29	2417.704 65(11)*	1067.33	0.164E-21	P(50) a	64	2423.137 3	83.06	0.312E-22	R(14) t
30	2417.766 1	22.15	0.221E-22	R(7) t	65	2423.328 33(11)*	828.95	0.451E-21	P(44) a
31	2418.043 9	284.13	0.191E-22	P(26) r	66	2423.573 13(43)	1209.60	0.100E-21	P(38) b
32	2418.399 65(43)	1457.34	0.366E-22	P(45) c	67	2423.772 84(44)	1243.48	0.875E-22	P(39) c
33	2418.539 6	28.48	0.241E-22	R(8) t	68	2423.896 3	94.93	0.314E-22	R(15) t
34	2418.565 0	100.55	0.103E-22	P(15) p	69	2423.966 1	153.82	0.259E-22	P(19) r
35	2418.649 27(11)*	1025.52	0.197E-21	P(49) a	70	2424.041 30(16)	1677.44	0.111E-22	P(34) f

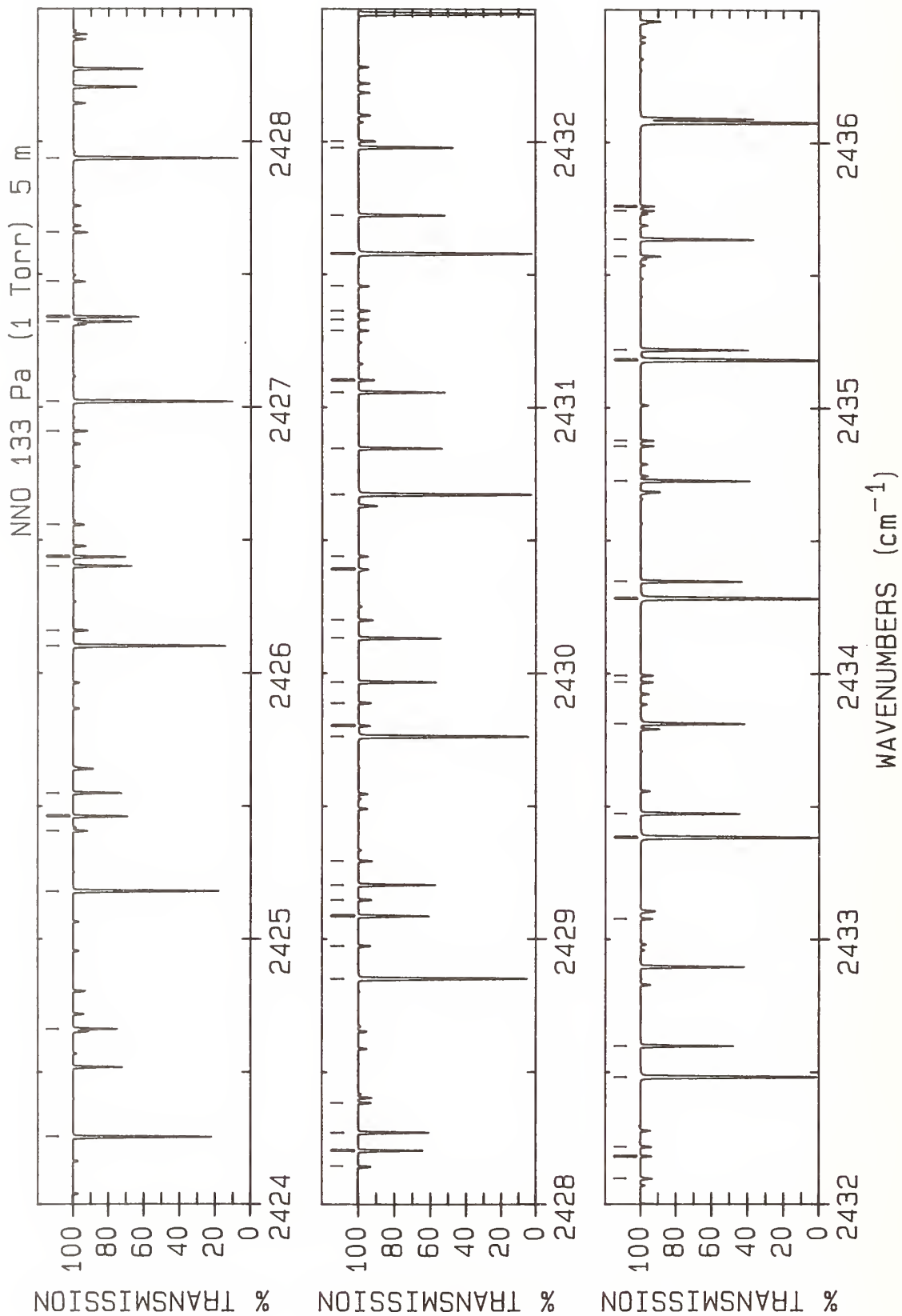

LINE #	WAVENUMBER(unc) (cm ⁻¹)	LOWER STATE (cm ⁻¹)	INTENSITY (cm/molecule)	ASSIGNMENT ROTATION BAND	LINE #	WAVENUMBER(unc) (cm ⁻¹)	LOWER STATE (cm ⁻¹)	INTENSITY (cm/molecule)	ASSIGNMENT ROTATION BAND
1	2424.255 61(11)*	792.14	0.525E-21	P(43) a	36	2430.439 23(13)	1495.29	0.209E-22	P(27) e
2	2424.662 44(44)	1210.77	0.996E-22	P(38) c	37	2430.671 96(11)*	557.81	0.134E-20	P(36) a
3	2425.180 15(11)*	756.16	0.609E-21	P(42) a	38	2430.845 73(38)	1005.20	0.215E-21	P(31) c
4	2425.407 7	121.03	0.313E-22	R(17) t	39	2431.056 18(36)	978.45	0.237E-21	P(30) b
5	2425.462 36(42)	1146.80	0.128E-21	P(36) b	40	2431.101 93(13)	1440.98	0.335E-22	P(25) g
6	2425.550 42(44)	1178.89	0.113E-21	P(37) c	41	2431.288 31(14)	1472.58	0.224E-22	P(26) f
7	2426.101 99(11)*	721.01	0.703E-21	P(41) a	42	2431.329 91(13)	1472.61	0.224E-22	P(26) e
8	2426.160 2	135.27	0.309E-22	R(18) t	43	2431.363 9	257.06	0.239E-22	R(25) t
9	2426.402 32(41)	1116.65	0.143E-21	P(35) b	44	2431.456 1	44.53	0.229E-22	P(10) r
10	2426.436 80(43)	1147.85	0.127E-21	P(36) c	45	2431.578 40(10)*	527.67	0.151E-20	P(35) a
11	2426.558 49(13)	1558.45	0.230E-22	P(30) g	46	2431.723 08(37)	979.18	0.236E-21	P(30) c
12	2426.910 4	150.30	0.303E-22	R(19) t	47	2431.977 87(35)	953.32	0.257E-21	P(29) b
13	2427.021 15(11)*	686.70	0.807E-21	P(40) a	48	2432.001 45(13)	1420.00	0.355E-22	P(24) g
14	2427.321 62(42)	1117.64	0.143E-21	P(35) c	49	2432.097 9	277.62	0.225E-22	R(26) t
15	2427.339 20(40)	1087.34	0.160E-21	P(34) b	50	2432.183 67(13)	1450.75	0.238E-22	P(25) f
16	2427.473 49(13)	1533.28	0.250E-22	P(29) g	51	2432.219 05(12)	1450.78	0.238E-22	P(25) e
17	2427.658 4	166.12	0.296E-22	R(20) t	52	2432.482 41(10)*	498.37	0.168E-20	P(34) a
18	2427.937 69(11)*	653.23	0.923E-21	P(39) a	53	2432.599 01(36)	954.01	0.257E-21	P(29) c
19	2428.143 8	85.01	0.265E-22	P(14) r	54	2433.076 73(13)	1429.76	0.252E-22	P(24) f
20	2428.204 90(42)	1088.28	0.159E-21	P(34) c	55	2433.384 03(10)*	469.91	0.187E-20	P(33) a
21	2428.273 01(39)	1058.86	0.178E-21	P(33) b	56	2433.473 52(35)	929.66	0.278E-21	P(28) c
22	2428.385 27(13)	1508.94	0.271E-22	P(28) g	57	2433.812 28(32)	905.56	0.301E-21	P(27) b
23	2428.851 65(11)*	620.59	0.105E-20	P(38) a	58	2433.967 52(12)	1409.60	0.266E-22	P(23) f
24	2428.974 3	73.68	0.259E-22	P(13) r	59	2433.992 55(11)	1409.62	0.266E-22	P(23) e
25	2429.086 66(41)	1059.75	0.177E-21	P(33) c	60	2434.283 30(10)*	442.28	0.207E-20	P(32) a
26	2429.147 6	200.12	0.276E-22	R(22) t	61	2434.346 66(34)	906.16	0.300E-21	P(27) c
27	2429.203 76(38)	1031.22	0.196E-21	P(32) b	62	2434.725 02(31)	882.94	0.322E-21	P(26) b
28	2429.293 90(13)	1485.45	0.292E-22	P(27) g	63	2434.856 03(12)	1390.28	0.279E-22	P(22) f
29	2429.763 06(11)*	588.78	0.119E-20	P(37) a	64	2434.876 82(11)	1390.30	0.279E-22	P(22) e
30	2429.803 2	63.15	0.252E-22	P(12) r	65	2435.180 26(10)*	415.49	0.227E-20	P(31) a
31	2429.888 8	218.31	0.265E-22	R(23) t	66	2435.218 42(33)	883.50	0.321E-21	P(26) c
32	2429.966 93(40)	1032.06	0.196E-21	P(32) c	67	2435.570 80(12)	1344.45	0.423E-22	P(20) g
33	2430.131 48(37)	1004.42	0.216E-21	P(31) b	68	2435.634 81(31)	861.16	0.344E-21	P(25) b
34	2430.199 44(13)	1462.80	0.314E-22	P(26) g	69	2435.742 30(11)	1371.80	0.290E-22	P(21) f
35	2430.390 65(14)	1495.26	0.209E-22	P(27) f	70	2435.759 40(10)	1371.82	0.290E-22	P(21) e

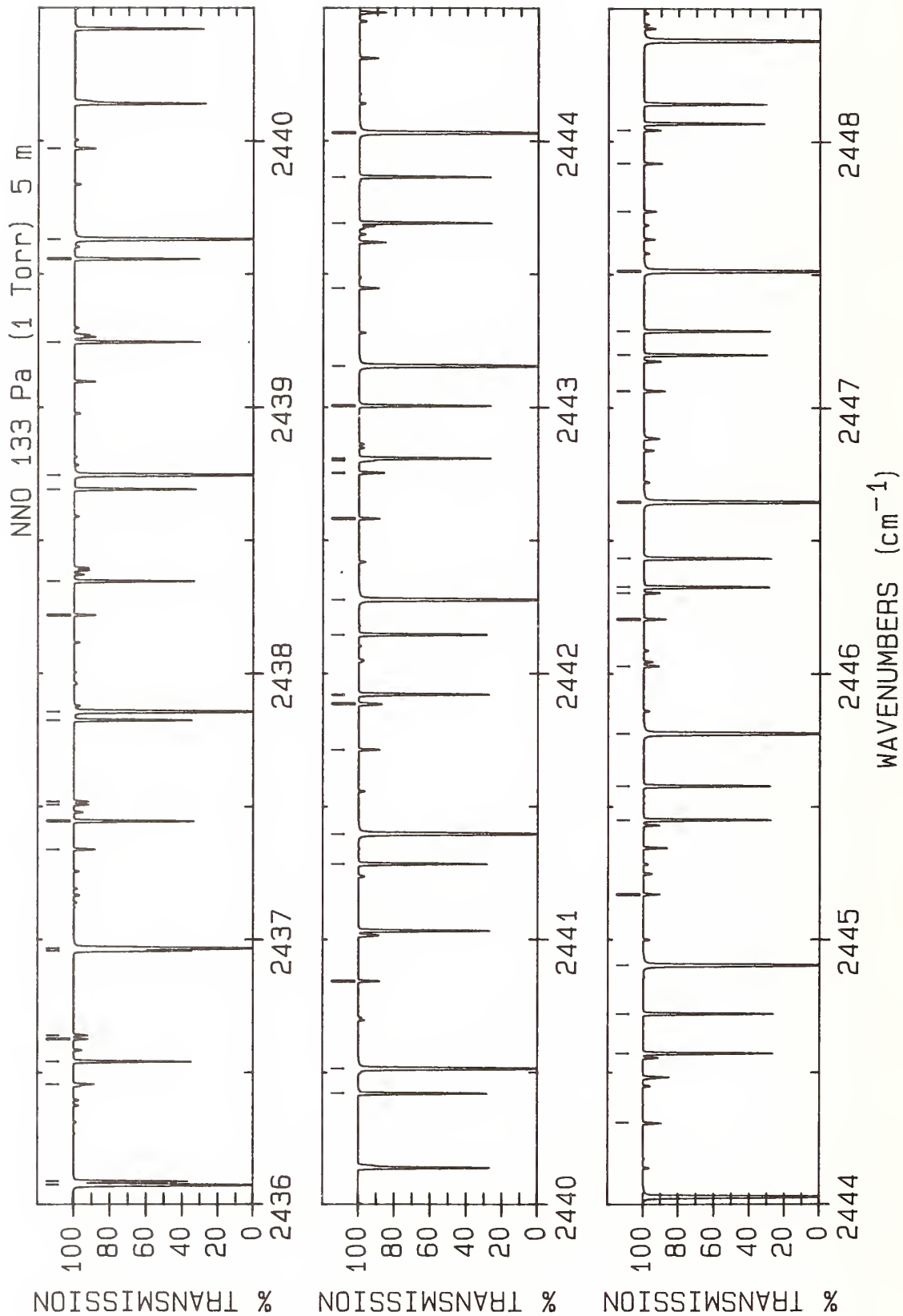

LINE #	WAVENUMBER(unc) (cm ⁻¹)	LOWER STATE (cm ⁻¹)	INTENSITY (cm/molecule)	ASSIGNMENT ROTATION BAND	LINE #	WAVENUMBER(unc) (cm ⁻¹)	LOWER STATE (cm ⁻¹)	INTENSITY (cm/molecule)	ASSIGNMENT ROTATION BAND
1	2436.074 95(10)*	389.53	0.249E-20	P(30) a	36	2442.752 30(14)	1254.20	0.309E-22	P(13) f
2	2436.088 83(32)	861.67	0.343E-21	P(25) c	37	2442.754 45(14)	1254.20	0.309E-22	P(13) e
3	2436.456 23(12)	1327.67	0.436E-22	P(19) g	38	2442.800 11(12)	1535.19	0.297E-22	P(24) d
4	2436.541 66(30)	840.21	0.364E-21	P(24) b	39	2442.808 09(30)	717.02	0.462E-21	P(17) b
5	2436.626 31(11)	1354.16	0.300E-22	P(20) f	40	2443.005 37(30)	717.26	0.461E-21	P(17) c
6	2436.640 23(10)	1354.18	0.300E-22	P(20) e	41	2443.154 60(10)*	211.97	0.424E-20	P(22) a
7	2436.957 91(31)	840.68	0.363E-21	P(24) c	42	2443.446 98(12)	1223.56	0.414E-22	P(11) g
8	2436.967 39(10)*	364.41	0.271E-20	P(29) a	43	2443.691 77(30)	702.77	0.465E-21	P(16) b
9	2437.338 98(12)	1311.72	0.445E-22	P(18) g	44	2443.864 29(30)	702.99	0.465E-21	P(16) c
10	2437.445 57(29)	820.10	0.384E-21	P(23) b	45	2444.030 31(10)*	193.54	0.442E-20	P(21) a
11	2437.508 10(11)	1337.37	0.309E-22	P(19) f	46	2444.309 79(13)	1214.32	0.393E-22	P(10) g
12	2437.519 30(10)	1337.38	0.309E-22	P(19) e	47	2444.572 59(31)	689.36	0.464E-21	P(15) b
13	2437.825 67(30)	820.54	0.383E-21	P(23) c	48	2444.721 99(31)	689.55	0.464E-21	P(15) c
14	2437.857 63(10)*	340.12	0.294E-20	P(28) a	49	2444.904 05(10)*	175.95	0.458E-20	P(20) a
15	2438.219 11(12)	1296.61	0.452E-22	P(17) g	50	2445.170 24(13)	1205.92	0.368E-22	P(9) g
16	2438.346 57(29)	800.83	0.402E-21	P(22) b	51	2445.450 56(32)	676.79	0.460E-21	P(14) b
17	2438.692 13(30)	801.23	0.402E-21	P(22) c	52	2445.578 47(31)	676.95	0.460E-21	P(14) c
18	2438.745 70(10)*	316.67	0.317E-20	P(27) a	53	2445.775 86(10)*	159.20	0.471E-20	P(19) a
19	2439.244 65(29)	782.39	0.419E-21	P(21) b	54	2446.028 36(13)	1198.37	0.339E-22	P(8) g
20	2439.557 30(29)	782.76	0.418E-21	P(21) c	55	2446.204 63(16)	1215.55	0.251E-22	P(9) f
21	2439.631 63(10)*	294.06	0.339E-20	P(26) a	56	2446.205 02(16)	1215.56	0.251E-22	P(9) e
22	2439.971 66(12)	1268.90	0.455E-22	P(15) g	57	2446.303 45(12)	1460.12	0.354E-22	P(20) d
23	2440.421 20(29)	765.12	0.433E-21	P(20) c	58	2446.325 69(32)	665.05	0.451E-21	P(13) b
24	2440.515 45(10)*	272.28	0.362E-20	P(25) a	59	2446.433 76(32)	665.20	0.451E-21	P(13) c
25	2440.844 16(12)	1256.31	0.451E-22	P(14) g	60	2446.645 76(10)*	143.28	0.481E-20	P(18) a
26	2441.283 84(29)	748.33	0.445E-21	P(19) c	61	2447.062 27(17)	1207.99	0.228E-22	P(8) f
27	2441.397 20(10)*	251.34	0.384E-20	P(24) a	62	2447.062 49(17)	1207.99	0.228E-22	P(8) e
28	2441.714 20(12)	1244.55	0.443E-22	P(13) g	63	2447.197 97(33)	654.15	0.438E-21	P(12) b
29	2441.883 77(13)	1265.96	0.316E-22	P(14) f	64	2447.287 84(33)	654.28	0.438E-21	P(12) c
30	2441.886 75(13)	1265.97	0.316E-22	P(14) e	65	2447.513 78(10)*	128.20	0.488E-20	P(17) a
31	2441.918 91(12)	1556.05	0.281E-22	P(25) d	66	2447.737 66(14)	1185.77	0.270E-22	P(6) g
32	2441.921 55(29)	732.11	0.456E-21	P(18) b	67	2447.917 74(18)	1201.27	0.202E-22	P(7) f
33	2442.145 22(29)	732.38	0.455E-21	P(18) c	68	2447.917 85(18)	1201.27	0.202E-22	P(7) e
34	2442.276 91(10)*	231.24	0.405E-20	P(23) a	69	2448.042 65(12)	1427.58	0.372E-22	P(18) d
35	2442.581 79(12)	1233.63	0.430E-22	P(12) g					

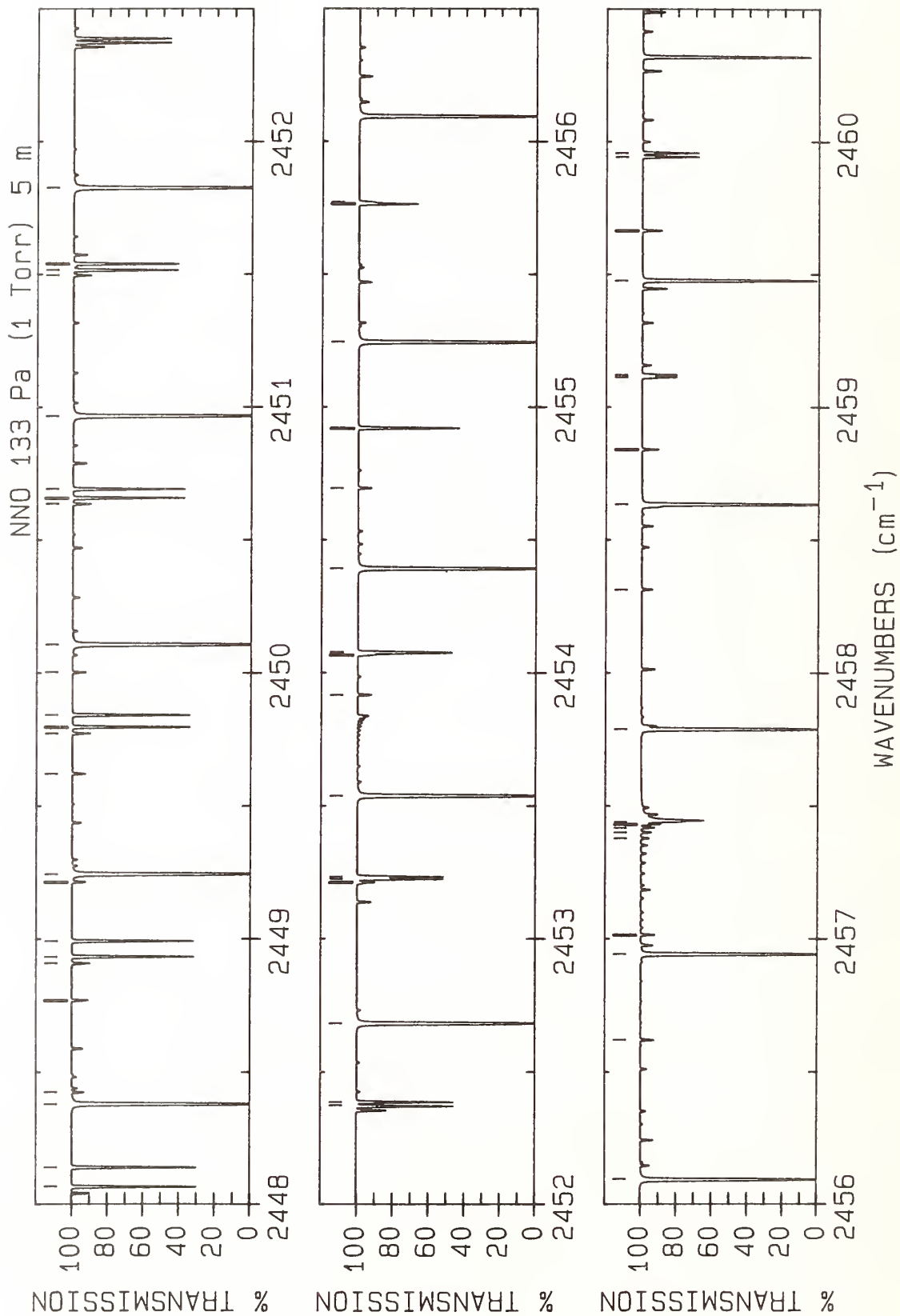

LINE #	WAVENUMBER(unc) (cm ⁻¹)	LOWER STATE (cm ⁻¹)	INTENSITY (cm/molecule)	ASSIGNMENT ROTATION BAND	LINE #	WAVENUMBER(unc) (cm ⁻¹)	LOWER STATE (cm ⁻¹)	INTENSITY (cm/molecule)	ASSIGNMENT ROTATION BAND
1	2448.067 42(34)	644.10	0.421E-21	P(11) b	36	2454.074 41(38)	597.15	0.181E-21	P(4) b
2	2448.140 74(34)	644.20	0.421E-21	P(11) c	37	2454.077 98(38)	597.17	0.181E-21	P(4) c
3	2448.379 93(10)*	113.96	0.492E-20	P(16) a	38	2454.392 21(10)*	37.71	0.397E-20	P(9) a
4	2448.424 7	44.53	0.254E-22	R(10) r	39	2454.694 6	138.44	0.283E-22	R(18) r
5	2448.771 04(18)	1195.39	0.172E-22	P(6) f	40	2454.920 49(14)	1330.80	0.327E-22	P(10) d
6	2448.771 08(18)	1195.39	0.172E-22	P(6) e	41	2454.921 26(39)	593.80	0.131E-21	P(3) b
7	2448.909 22(12)	1412.57	0.377E-22	P(17) d	42	2454.921 46(39)	593.81	0.131E-21	P(3) c
8	2448.934 04(35)	634.88	0.399E-21	P(10) b	43	2455.244 03(10)*	30.17	0.366E-20	P(8) a
9	2448.992 45(35)	634.96	0.399E-21	P(10) c	44	2455.763 76(39)	591.29	0.745E-22	P(2) c
10	2449.214 6	53.44	0.266E-22	R(11) r	45	2455.765 28(39)	591.28	0.745E-22	P(2) b
11	2449.244 23(10)*	100.55	0.491E-20	P(15) a	46	2455.771 62(14)	1322.45	0.306E-22	P(9) d
12	2449.622 17(19)	1190.35	0.139E-22	P(5) f	47	2456.094 11(10)*	23.46	0.331E-20	P(7) a
13	2449.622 18(19)	1190.35	0.139E-22	P(5) e	48	2456.620 89(14)	1314.94	0.282E-22	P(8) d
14	2449.773 80(12)	1398.38	0.379E-22	P(16) d	49	2456.942 47(10)*	17.60	0.292E-20	P(6) a
15	2449.797 83(36)	626.49	0.373E-21	P(9) b	50	2457.014 36(8)	193.54	0.397E-23	P(21) x
16	2449.842 98(36)	626.56	0.373E-21	P(9) c	51	2457.015 1	187.01	0.261E-22	R(21) r
17	2450.002 9	63.15	0.275E-22	R(12) r	52	2457.378 47(38)	601.37	0.173E-22	Q(5) c
18	2450.106 70(10)*	87.98	0.487E-20	P(14) a	53	2457.400 59(38)	597.17	0.217E-22	Q(4) c
19	2450.636 40(13)	1385.04	0.379E-22	P(15) d	54	2457.418 29(38)	593.81	0.286E-22	Q(3) c
20	2450.658 79(36)	618.95	0.342E-21	P(8) b	55	2457.431 55(39)	591.29	0.414E-22	Q(2) c
21	2450.692 33(36)	619.00	0.342E-21	P(8) c	56	2457.440 40(39)	589.61	0.751E-22	Q(1) c
22	2450.967 36(10)*	76.25	0.478E-20	P(13) a	57	2457.789 09(10)*	12.57	0.249E-20	P(5) a
23	2451.497 05(13)	1372.52	0.376E-22	P(14) d	58	2458.313 85(14)	1302.43	0.225E-22	P(6) d
24	2451.516 93(37)	612.24	0.308E-21	P(7) b	59	2458.634 00(10)*	8.38	0.203E-20	P(4) a
25	2451.540 50(37)	612.29	0.308E-21	P(7) c	60	2458.840 62(18)	1190.35	0.177E-22	R(5) f
26	2451.826 23(10)*	65.36	0.464E-20	P(12) a	61	2458.840 86(18)	1190.35	0.177E-22	R(5) e
27	2452.372 25(38)	606.37	0.269E-21	P(6) b	62	2459.113 01(39)	589.61	0.752E-22	R(1) b
28	2452.387 50(38)	606.41	0.269E-21	P(6) c	63	2459.121 13(39)	589.61	0.752E-22	R(1) c
29	2452.683 32(10)*	55.31	0.447E-20	P(11) a	64	2459.477 18(10)*	5.03	0.155E-20	P(3) a
30	2453.212 58(13)	1349.99	0.358E-22	P(12) d	65	2459.665 44(17)	1195.39	0.209E-22	R(6) f
31	2453.224 74(38)	601.34	0.227E-21	P(5) b	66	2459.665 86(17)	1195.39	0.209E-22	R(6) e
32	2453.233 33(38)	601.37	0.227E-21	P(5) c	67	2459.942 84(38)	591.28	0.133E-21	R(2) b
33	2453.538 64(10)*	46.09	0.424E-20	P(10) a	68	2459.957 49(38)	591.29	0.133E-21	R(2) c
34	2453.917 2	123.87	0.287E-22	R(17) r					
35	2454.067 48(13)	1339.98	0.344E-22	P(11) d					

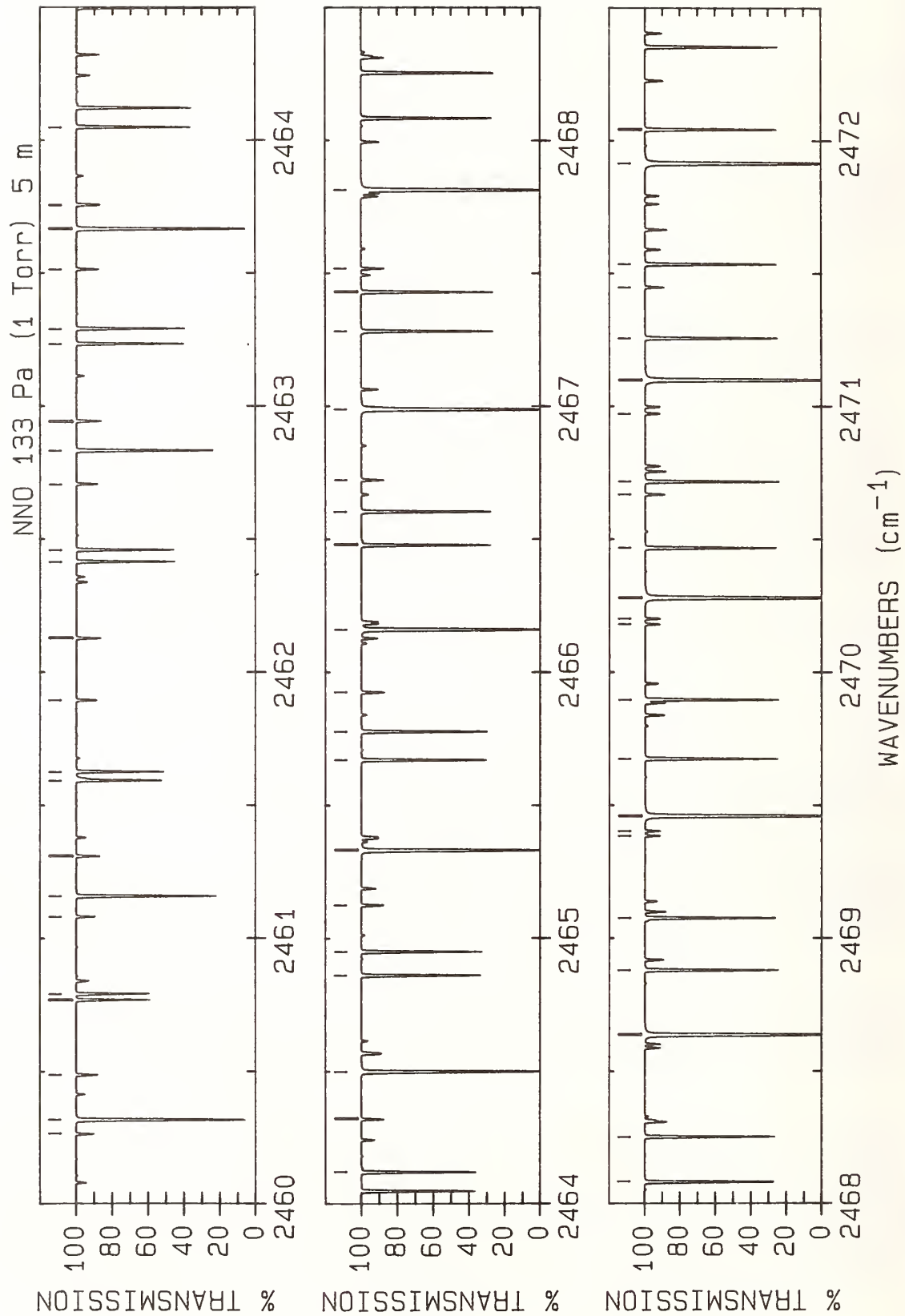

LINE #	WAVENUMBER(unc) (cm ⁻¹)	LOWER STATE (cm ⁻¹)	INTENSITY (cm/molecule)	ASSIGNMENT ROTATION BAND	LINE #	WAVENUMBER(unc) (cm ⁻¹)	LOWER STATE (cm ⁻¹)	INTENSITY (cm/molecule)	ASSIGNMENT ROTATION BAND
1	2460.265 04(13)	1198.37	0.384E-22	R(8) g	36	2465.671 23(34)	626.49	0.418E-21	R(9) b
2	2460.318 65(10)*	2.51	0.105E-20	P(2) a	37	2465.777 81(34)	626.56	0.418E-21	R(9) c
3	2460.488 02(16)	1201.27	0.237E-22	R(7) f	38	2465.924 94(12)	1268.90	0.491E-22	R(15) g
4	2460.488 70(16)	1201.27	0.237E-22	R(7) e	39	2466.160 47(10)*	8.38	0.255E-20	R(4) a
5	2460.769 81(38)	593.80	0.184E-21	R(3) b	40	2466.477 98(33)	634.88	0.443E-21	R(10) b
6	2460.792 65(38)	593.81	0.184E-21	R(3) c	41	2466.604 27(33)	634.96	0.443E-21	R(10) c
7	2461.081 32(12)	1205.92	0.412E-22	R(9) g	42	2466.722 78(12)	1282.33	0.490E-22	R(16) g
8	2461.158 39(10)*	0.84	0.527E-21	P(1) a	43	2466.988 01(10)*	12.57	0.300E-20	R(5) a
9	2461.308 35(16)	1207.99	0.262E-22	R(8) f	44	2467.281 79(32)	644.10	0.464E-21	R(11) b
10	2461.309 41(16)	1207.99	0.262E-22	R(8) e	45	2467.429 44(32)	644.20	0.464E-21	R(11) c
11	2461.593 92(38)	597.15	0.232E-21	R(4) b	46	2467.517 80(12)	1296.61	0.485E-22	R(17) g
12	2461.626 60(38)	597.17	0.232E-21	R(4) c	47	2467.813 76(10)*	17.60	0.342E-20	R(6) a
13	2461.895 09(12)	1214.32	0.436E-22	R(10) g	48	2468.082 65(32)	654.15	0.480E-21	R(12) b
14	2462.126 43(15)	1215.55	0.283E-22	R(9) f	49	2468.253 30(31)	654.28	0.480E-21	R(12) c
15	2462.127 99(15)	1215.56	0.283E-22	R(9) e	50	2468.637 71(10)*	23.46	0.380E-20	R(7) a
16	2462.415 16(37)	601.34	0.277E-21	R(5) b	51	2468.880 55(31)	665.05	0.491E-21	R(13) b
17	2462.459 32(37)	601.37	0.277E-21	R(5) c	52	2469.075 85(31)	665.20	0.491E-21	R(13) c
18	2462.706 32(12)	1223.56	0.456E-22	R(11) g	53	2469.385 37(11)	1321.41	0.338E-22	R(18) f
19	2462.832 71(10)*	0.00	0.530E-21	R(0) a	54	2469.402 79(10)	1321.41	0.338E-22	R(18) e
20	2462.942 24(14)	1223.96	0.302E-22	R(10) f	55	2469.459 84(10)*	30.17	0.415E-20	R(8) a
21	2462.944 46(14)	1223.96	0.302E-22	R(10) e	56	2469.675 48(30)	676.79	0.499E-21	R(14) b
22	2463.233 52(36)	606.37	0.318E-21	R(6) b	57	2469.897 06(30)	676.95	0.498E-21	R(14) c
23	2463.290 81(36)	606.41	0.318E-21	R(6) c	58	2470.180 11(11)	1337.37	0.330E-22	R(19) f
24	2463.514 96(12)	1233.63	0.471E-22	R(12) g	59	2470.201 27(10)	1337.38	0.330E-22	R(19) e
25	2463.667 27(10)*	0.84	0.106E-20	R(1) a	60	2470.280 14(10)*	37.71	0.445E-20	R(9) a
26	2463.755 76(14)	1233.20	0.317E-22	R(11) f	61	2470.467 41(30)	689.36	0.502E-21	R(15) b
27	2463.758 84(14)	1233.20	0.317E-22	R(11) e	62	2470.668 40(13)	1362.08	0.435E-22	R(21) g
28	2464.049 00(36)	612.24	0.356E-21	R(7) b	63	2470.716 92(30)	689.55	0.501E-21	R(15) c
29	2464.121 07(36)	612.29	0.356E-21	R(7) c	64	2470.972 43(12)	1354.16	0.321E-22	R(20) f
30	2464.320 98(12)	1244.55	0.482E-22	R(13) g	65	2471.098 58(10)*	46.09	0.471E-20	R(10) a
31	2464.500 09(10)*	2.51	0.157E-20	R(2) a	66	2471.256 34(29)	702.77	0.501E-21	R(16) b
32	2464.861 57(35)	618.95	0.389E-21	R(8) b	67	2471.448 38(13)	1380.55	0.417E-22	R(22) g
33	2464.950 07(35)	619.00	0.389E-21	R(8) c	68	2471.535 41(29)	702.99	0.500E-21	R(16) c
34	2465.124 32(12)	1256.31	0.488E-22	R(14) g	69	2471.915 15(10)*	55.31	0.492E-20	R(11) a
35	2465.331 16(10)*	5.03	0.207E-20	R(3) a	70	2472.042 25(29)	717.02	0.496E-21	R(17) b

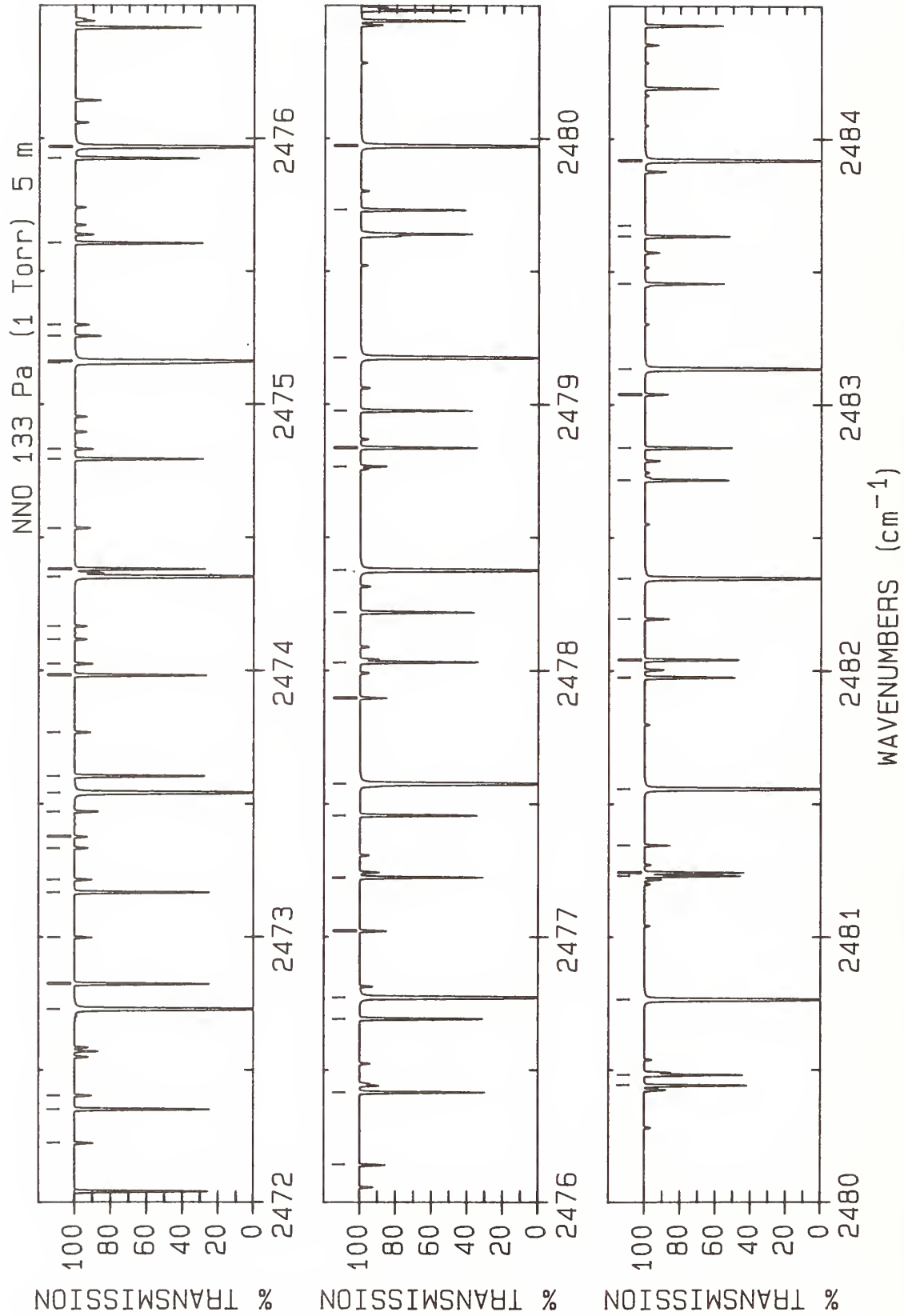

LINE #	WAVENUMBER(unc) (cm ⁻¹)	LOWER STATE (cm ⁻¹)	INTENSITY (cm/molecule)	ASSIGNMENT ROTATION BAND	LINE #	WAVENUMBER(unc) (cm ⁻¹)	LOWER STATE (cm ⁻¹)	INTENSITY (cm/molecule)	ASSIGNMENT ROTATION BAND
1	2472.225 16(13)	1399.85	0.398E-22	R(23) g	36	2477.221 27(15)	1518.77	0.205E-22	R(28) f
2	2472.352 51(29)	717.26	0.496E-21	R(17) c	37	2477.224 76(32)	820.54	0.407E-21	R(23) c
3	2472.404 20(13)	1330.80	0.363E-22	R(10) d	38	2477.457 48(31)	840.21	0.387E-21	R(24) b
4	2472.729 81(10)*	65.36	0.508E-20	R(12) a	39	2477.576 44(10)*	143.28	0.515E-20	R(18) a
5	2472.825 12(29)	732.11	0.488E-21	R(18) b	40	2477.897 6	107.58	0.584E-22	P(16) T
6	2472.998 68(13)	1420.00	0.377E-22	R(24) g	41	2478.031 53(33)	840.68	0.386E-21	R(24) c
7	2473.168 19(29)	732.38	0.488E-21	R(18) c	42	2478.218 55(32)	861.16	0.365E-21	R(25) b
8	2473.215 82(13)	1339.98	0.379E-22	R(11) d	43	2478.377 05(10)*	159.20	0.503E-20	R(19) a
9	2473.334 64(13)	1409.60	0.283E-22	R(23) f	44	2478.767 4	94.93	0.582E-22	P(15) T
10	2473.376 90(12)	1409.62	0.283E-22	R(23) e	45	2478.836 74(34)	861.67	0.364E-21	R(25) c
11	2473.471 5	182.72	0.531E-22	P(21) T	46	2478.839 09(12)	1427.58	0.398E-22	R(18) d
12	2473.542 55(10)*	76.25	0.520E-20	R(13) a	47	2478.976 43(34)	882.94	0.342E-21	R(26) b
13	2473.604 93(29)	748.03	0.477E-21	R(19) b	48	2479.175 52(10)*	175.95	0.488E-20	R(20) a
14	2473.768 87(13)	1440.98	0.355E-22	R(25) g	49	2479.731 09(35)	905.56	0.319E-21	R(27) b
15	2473.982 45(29)	748.33	0.476E-21	R(19) c	50	2479.971 83(10)*	193.54	0.471E-20	R(21) a
16	2474.025 42(13)	1349.99	0.392E-22	R(12) d	51	2480.442 33(36)	906.16	0.318E-21	R(27) c
17	2474.117 07(14)	1429.76	0.268E-22	R(24) f	52	2480.482 51(36)	929.02	0.295E-21	R(28) b
18	2474.166 39(13)	1429.78	0.268E-22	R(24) e	53	2480.765 93(10)*	211.97	0.451E-20	R(22) a
19	2474.353 34(10)*	87.98	0.527E-20	R(14) a	54	2481.230 67(37)	953.32	0.273E-21	R(29) b
20	2474.381 67(29)	764.79	0.463E-21	R(20) b	55	2481.242 66(37)	929.66	0.295E-21	R(28) c
21	2474.535 66(13)	1462.80	0.332E-22	R(26) g	56	2481.345 8	61.71	0.548E-22	P(12) T
22	2474.795 26(30)	765.12	0.462E-21	R(20) c	57	2481.557 78(10)*	231.24	0.430E-20	R(23) a
23	2474.832 97(13)	1360.84	0.401E-22	R(13) d	58	2481.973 06(18)	1677.52	0.117E-22	R(34) e
24	2475.155 31(29)	782.39	0.447E-21	R(21) b	59	2481.975 55(38)	978.45	0.250E-21	R(30) b
25	2475.162 16(10)*	100.55	0.530E-20	R(15) a	60	2482.041 32(38)	954.01	0.272E-21	R(29) c
26	2475.257 3	150.30	0.562E-22	P(19) T	61	2482.194 8	52.21	0.526E-22	P(11) T
27	2475.298 98(13)	1485.45	0.310E-22	R(27) g	62	2482.347 36(10)*	251.34	0.408E-20	R(24) a
28	2475.606 60(30)	782.76	0.446E-21	R(21) c	63	2482.717 12(39)	1004.42	0.229E-21	R(31) b
29	2475.925 84(30)	800.83	0.428E-21	R(22) b	64	2482.838 26(40)	979.18	0.249E-21	R(30) c
30	2475.968 97(10)*	113.96	0.529E-20	R(16) a	65	2483.038 7	43.51	0.499E-22	P(10) T
31	2476.142 5	135.27	0.573E-22	P(18) T	66	2483.134 62(10)*	272.28	0.384E-20	R(25) a
32	2476.416 44(31)	801.23	0.427E-21	R(22) c	67	2483.455 36(40)	1031.22	0.208E-21	R(32) b
33	2476.693 24(31)	820.10	0.408E-21	R(23) b	68	2483.633 46(41)	1005.20	0.228E-21	R(31) c
34	2476.773 74(10)*	128.20	0.524E-20	R(17) a	69	2483.674 59(24)*	2320.08	0.237E-23	P(74) A
35	2477.022 6	121.03	0.581E-22	P(17) T	70	2483.919 51(10)*	294.06	0.360E-20	R(26) a

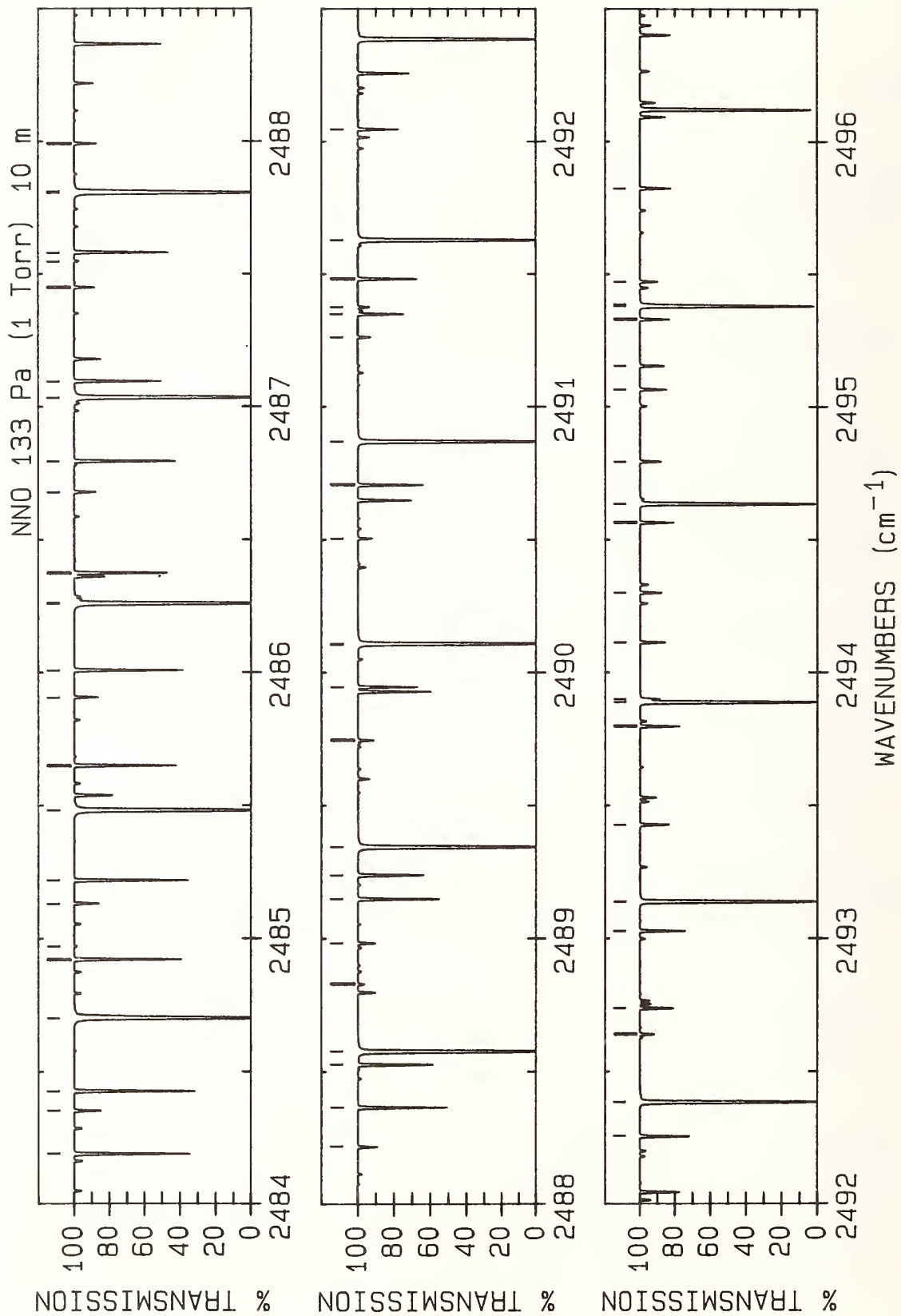

LINE #	WAVENUMBER(unc) (cm ⁻¹)	LOWER STATE (cm ⁻¹)	INTENSITY (cm/molecule)	ASSIGNMENT ROTATION BAND	LINE #	WAVENUMBER(unc) (cm ⁻¹)	LOWER STATE (cm ⁻¹)	INTENSITY (cm/molecule)	ASSIGNMENT ROTATION BAND
1	2484.190 24(41)	1058.86	0.188E-21	R(33) b	36	2489.945 60(44)	1310.06	0.710E-22	R(41) b
2	2484.353 23(13)	1556.05	0.298E-22	R(25) d	37	2490.105 32(12)*	2019.71	0.954E-23	P(69) A
3	2484.426 89(42)	1032.06	0.207E-21	R(32) c	38	2490.108 45(11)*	498.37	0.178E-20	R(34) a
4	2484.702 00(10)*	316.67	0.335E-20	R(27) a	39	2490.504 96(13)	1752.85	0.154E-22	R(33) d
5	2484.921 75(42)	1087.34	0.169E-21	R(34) b	40	2490.706 45(44)	1277.04	0.810E-22	R(40) c
6	2484.971 22(21)*	2258.36	0.316E-23	P(73) A	41	2490.870 11(11)*	527.67	0.159E-20	R(35) a
7	2485.131 34(13)	1577.73	0.279E-22	R(26) d	42	2491.261 64(13)	1781.19	0.139E-22	R(34) d
8	2485.218 51(42)	1059.75	0.187E-21	R(33) c	43	2491.349 16(43)	1381.21	0.532E-22	R(43) b
9	2485.482 04(10)*	340.12	0.311E-20	R(28) a	44	2491.375 48(11)*	1962.12	0.125E-22	P(68) A
10	2485.649 85(43)	1116.65	0.152E-21	R(35) b	45	2491.482 37(44)	1311.42	0.705E-22	R(41) c
11	2485.906 92(13)	1600.25	0.260E-22	R(27) d	46	2491.628 95(11)*	557.81	0.142E-20	R(36) a
12	2486.008 30(43)	1088.28	0.168E-21	R(34) c	47	2492.045 50(43)	1418.04	0.457E-22	R(44) b
13	2486.259 60(10)*	364.41	0.287E-20	R(29) a	48	2492.256 16(43)	1346.65	0.612E-22	R(42) c
14	2486.262 66(18)*	2197.45	0.419E-23	P(72) A	49	2492.384 94(11)*	588.78	0.126E-20	R(37) a
15	2486.374 52(43)	1146.80	0.135E-21	R(36) b	50	2492.640 20(10)*	1905.36	0.162E-22	P(67) A
16	2486.679 94(13)	1623.60	0.242E-22	R(28) d	51	2492.738 18(43)	1455.70	0.391E-22	R(45) b
17	2486.796 21(44)	1117.64	0.151E-21	R(35) c	52	2493.027 78(43)	1382.71	0.528E-22	R(43) c
18	2487.034 62(10)*	389.53	0.263E-20	R(30) a	53	2493.138 01(11)*	620.59	0.111E-20	R(38) a
19	2487.095 75(44)	1177.78	0.120E-21	R(37) b	54	2493.427 18(44)	1494.20	0.333E-22	R(46) b
20	2487.450 34(13)	1647.79	0.223E-22	R(29) d	55	2493.797 19(43)	1419.61	0.453E-22	R(44) c
21	2487.548 86(15)*	2137.38	0.554E-23	P(71) A	56	2493.888 12(11)*	653.23	0.975E-21	R(39) a
22	2487.582 22(44)	1147.85	0.135E-21	R(36) c	57	2493.899 42(10)*	1849.42	0.209E-22	P(66) A
23	2487.807 06(10)*	415.49	0.240E-20	R(31) a	58	2494.112 47(44)	1533.53	0.283E-22	R(47) b
24	2487.813 49(44)	1209.60	0.106E-21	R(38) b	59	2494.299 5	4.75	0.242E-22	R(3) T
25	2487.991 5	7.91	0.238E-22	P(4) T	60	2494.564 34(43)	1457.34	0.388E-22	R(45) c
26	2488.218 09(13)	1672.80	0.205E-22	R(30) d	61	2494.635 22(11)*	686.70	0.853E-21	R(40) a
27	2488.366 28(44)	1178.89	0.119E-21	R(37) c	62	2494.794 02(46)	1573.69	0.238E-22	R(48) b
28	2488.527 73(44)	1242.25	0.931E-22	R(39) b	63	2495.064 1	7.91	0.298E-22	R(4) T
29	2488.576 88(10)*	442.28	0.218E-20	R(32) a	64	2495.153 10(10)*	1794.32	0.269E-22	P(65) A
30	2488.829 76(14)*	2078.13	0.728E-23	P(70) A	65	2495.329 19(44)	1495.90	0.330E-22	R(46) c
31	2488.983 14(13)	1698.65	0.187E-22	R(31) d	66	2495.379 27(11)*	721.01	0.742E-21	R(41) a
32	2489.148 37(44)	1210.77	0.105E-21	R(38) c	67	2495.386 1	730.64	0.109E-22	P(42) R
33	2489.238 45(44)	1275.74	0.815E-22	R(40) b	68	2495.471 81(48)	1614.68	0.200E-22	R(49) b
34	2489.344 02(10)*	469.91	0.198E-20	R(33) a	69	2495.823 4	11.87	0.351E-22	R(5) T
35	2489.745 45(13)	1725.33	0.170E-22	R(32) d					

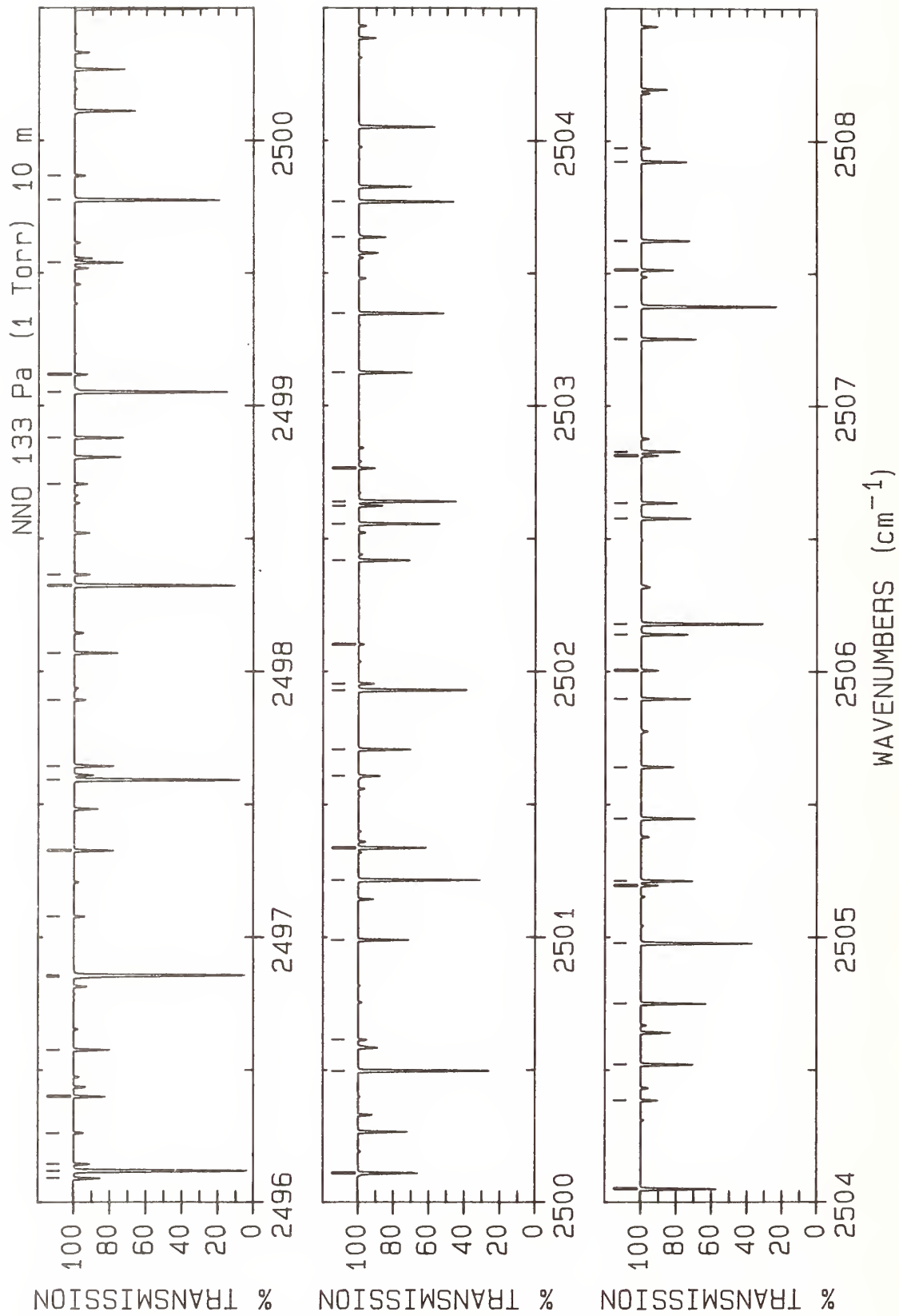

LINE #	WAVENUMBER(unc) (cm ⁻¹)	LOWER STATE (cm ⁻¹)	INTENSITY (cm/molecule)	ASSIGNMENT ROTATION BAND	LINE #	WAVENUMBER(unc) (cm ⁻¹)	LOWER STATE (cm ⁻¹)	INTENSITY (cm/molecule)	ASSIGNMENT ROTATION BAND
1	2496.091 70(46)	1535.31	0.280E-22	R(47) c	36	2502.418 6	83.06	0.622E-22	R(14) T
2	2496.120 20(11)*	756.16	0.644E-21	R(42) a	37	2502.556 42(10)*	1481.09	0.112E-21	P(59) A
3	2496.145 81(52)	1656.51	0.168E-22	R(50) b	38	2502.624 6	509.86	0.265E-22	P(35) R
4	2496.263 74(9)	272.28	0.105E-22	R(25) x	39	2502.640 83(11)*	1109.98	0.145E-21	R(51) a
5	2496.401 20(10)*	1740.04	0.346E-22	P(64) A	40	2502.765 52(13)	469.91	0.178E-22	R(33) x
6	2496.577 4	16.61	0.400E-22	R(6) T	41	2503.125 0	94.93	0.627E-22	R(15) T
7	2496.851 83(48)	1575.55	0.236E-22	R(48) c	42	2503.348 06(11)*	1153.46	0.120E-21	R(52) a
8	2496.857 99(11)*	792.14	0.555E-21	R(43) a	43	2503.636 1	481.55	0.296E-22	P(34) R
9	2497.078 45(10)	294.06	0.116E-22	R(26) x	44	2503.770 13(10)*	1431.79	0.141E-21	P(58) A
10	2497.326 1	22.15	0.445E-22	R(7) T	45	2504.051 66(11)*	1197.77	0.991E-22	R(53) a
11	2497.592 56(11)*	828.95	0.477E-21	R(44) a	46	2504.386 13(13)	527.67	0.186E-22	R(35) x
12	2497.643 67(10)*	1686.59	0.441E-22	P(63) A	47	2504.522 0	121.03	0.621E-22	R(17) T
13	2497.892 53(10)	316.67	0.127E-22	R(27) x	48	2504.751 59(11)*	1242.91	0.814E-22	R(54) a
14	2498.069 5	28.48	0.486E-22	R(8) T	49	2504.977 98(9)*	1383.33	0.175E-21	P(57) A
15	2498.323 88(11)*	866.60	0.407E-21	R(45) a	50	2505.195 87(14)	557.81	0.188E-22	R(36) x
16	2498.364 75(55)	1658.53	0.166E-22	R(50) c	51	2505.212 6	135.27	0.612E-22	R(18) T
17	2498.706 02(11)	340.12	0.138E-22	R(28) x	52	2505.447 81(11)*	1288.88	0.666E-22	R(55) a
18	2498.880 46(10)*	1633.97	0.561E-22	P(62) A	53	2505.641 9	427.35	0.363E-22	P(32) R
19	2499.051 91(11)*	905.08	0.347E-21	R(46) a	54	2505.898 0	150.30	0.599E-22	R(19) T
20	2499.117 46(60)	1701.27	0.138E-22	R(51) c	55	2506.005 27(14)	588.78	0.188E-22	R(37) x
21	2499.540 4	43.51	0.553E-22	R(10) T	56	2506.140 28(11)*	1335.69	0.542E-22	R(56) a
22	2499.776 58(11)*	944.39	0.294E-21	R(47) a	57	2506.179 92(9)*	1335.69	0.217E-21	P(56) A
23	2499.867 60(66)	1744.84	0.115E-22	R(52) c	58	2506.578 1	166.12	0.583E-22	R(20) T
24	2500.108 77(97)	1924.97	0.527E-23	R(56) b	59	2506.636 2	401.46	0.399E-22	P(31) R
25	2500.111 55(10)*	1582.18	0.710E-22	P(61) A	60	2506.814 35(14)	620.59	0.186E-22	R(38) x
26	2500.497 85(11)*	984.54	0.248E-21	R(48) a	61	2506.828 95(11)*	1383.33	0.440E-22	R(57) a
27	2500.615 12(74)	1789.25	0.947E-23	R(53) c	62	2507.252 3	170.77	0.944E-23	P(20) V
28	2500.990 1	61.71	0.598E-22	R(12) T	63	2507.253 1	182.72	0.563E-22	R(21) T
29	2501.215 69(11)*	1025.52	0.208E-21	R(49) a	64	2507.375 93(9)*	1288.88	0.267E-21	P(55) A
30	2501.336 88(10)*	1531.22	0.896E-22	P(60) A	65	2507.513 79(11)*	1431.79	0.355E-22	R(58) a
31	2501.607 4	538.98	0.237E-22	P(36) R	66	2507.623 16(14)	653.23	0.184E-22	R(39) x
32	2501.707 0	71.99	0.613E-22	R(13) T	67	2507.624 8	376.38	0.436E-22	P(30) R
33	2501.930 03(11)*	1067.33	0.174E-21	R(50) a	68	2507.922 8	200.12	0.541E-22	R(22) T
34	2501.954 59(12)	442.28	0.172E-22	R(32) x	69	2507.974 46(15)	2147.88	0.100E-22	P(45) D
35	2502.102 15(92)	1880.57	0.637E-23	R(55) c					

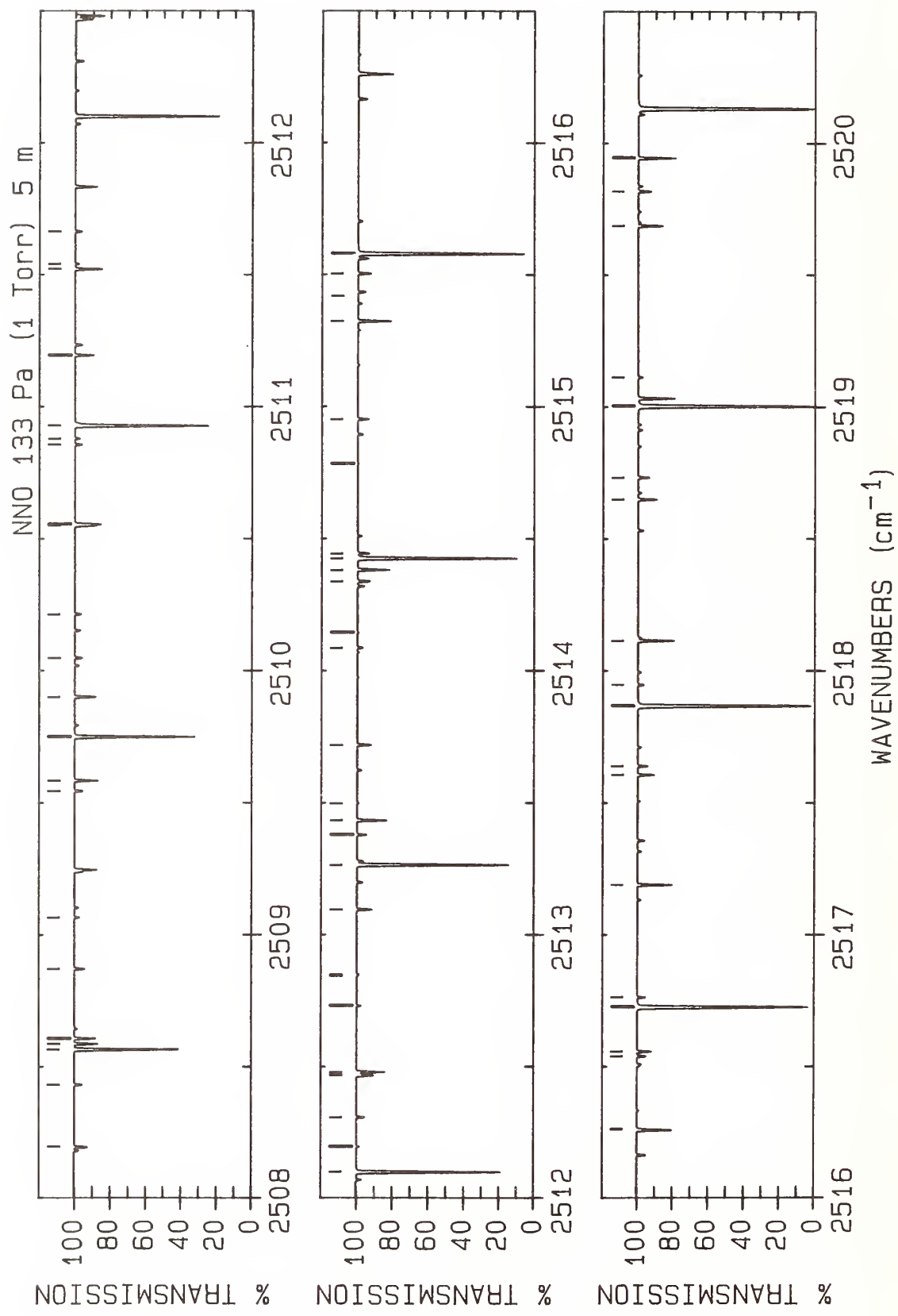

LINE #	WAVENUMBER(unc) (cm ⁻¹)	LOWER STATE (cm ⁻¹)	INTENSITY (cm/molecule)	ASSIGNMENT ROTATION BAND	LINE #	WAVENUMBER(unc) (cm ⁻¹)	LOWER STATE (cm ⁻¹)	INTENSITY (cm/molecule)	ASSIGNMENT ROTATION BAND
1	2508.194 75(11)*	1481.09	0.286E-22	R(59) a	36	2513.434 2	242.85	0.669E-22	P(24) R
2	2508.431 72(14)	686.70	0.180E-22	R(40) x	37	2513.498 67(18)*	1905.36	0.428E-23	R(67) a
3	2508.565 97(9)*	1242.91	0.328E-21	P(54) A	38	2513.719 6	392.26	0.297E-22	R(31) T
4	2508.587 4	218.31	0.517E-22	R(23) T	39	2514.086 97(14)	944.39	0.126E-22	R(47) x
5	2508.607 6	352.10	0.474E-22	P(29) R	40	2514.143 18(20)*	1962.12	0.331E-23	R(68) a
6	2508.871 81(11)*	1531.22	0.229E-22	R(60) a	41	2514.338 3	417.55	0.271E-22	R(32) T
7	2509.065 91(15)	2110.39	0.118E-22	P(44) D	42	2514.382 0	223.43	0.705E-22	P(23) R
8	2509.544 91(12)*	1582.18	0.182E-22	R(61) a	43	2514.425 53(9)*	1025.52	0.859E-21	P(49) A
9	2509.584 6	328.64	0.513E-22	P(28) R	44	2514.444 35(13)	1935.40	0.245E-22	P(39) D
10	2509.750 01(9)*	1197.77	0.401E-21	P(53) A	45	2514.783 48(23)*	2019.71	0.255E-23	R(69) a
11	2509.901 1	257.06	0.465E-22	R(25) T	46	2514.952 1	443.64	0.246E-22	R(33) T
12	2510.048 20(14)	756.16	0.168E-22	R(42) x	47	2515.323 9	204.82	0.738E-22	P(22) R
13	2510.214 03(12)*	1633.97	0.145E-22	R(62) a	48	2515.419 54(26)*	2078.13	0.196E-23	R(70) a
14	2510.550 2	277.62	0.437E-22	R(26) T	49	2515.503 97(13)	1902.90	0.280E-22	P(38) D
15	2510.555 7	305.98	0.553E-22	P(27) R	50	2515.579 10(9)*	984.54	0.103E-20	P(48) A
16	2510.856 18(14)	792.14	0.161E-22	R(43) x	51	2516.259 8	187.01	0.769E-22	P(21) R
17	2510.879 13(13)*	1686.59	0.114E-22	R(63) a	52	2516.264 2	44.73	0.874E-23	P(10) V
18	2510.928 02(9)*	1153.46	0.489E-21	P(52) A	53	2516.540 6	588.74	0.198E-22	P(37) P
19	2510.929 0	110.60	0.101E-22	P(16) V	54	2516.558 12(13)	1871.22	0.318E-22	P(37) D
20	2511.194 2	298.97	0.408E-22	R(27) T	55	2516.726 50(9)*	944.39	0.122E-20	P(47) A
21	2511.521 1	284.13	0.593E-22	P(26) R	56	2516.764 0	526.63	0.179E-22	R(36) T
22	2511.540 18(13)*	1740.04	0.900E-23	R(64) a	57	2517.189 9	170.01	0.796E-22	P(20) R
23	2511.664 01(14)	828.95	0.153E-22	R(44) x	58	2517.606 79(12)	1840.38	0.360E-22	P(36) D
24	2512.099 96(9)*	1109.98	0.592E-21	P(51) A	59	2517.640 2	557.77	0.224E-22	P(36) P
25	2512.197 14(14)*	1794.32	0.706E-23	R(65) a	60	2517.867 69(9)*	905.08	0.145E-20	P(46) A
26	2512.308 92(14)	2002.90	0.185E-22	P(41) D	61	2517.947 5	585.90	0.141E-22	R(38) T
27	2512.467 0	344.03	0.351E-22	R(29) T	62	2518.114 0	153.82	0.818E-22	P(19) R
28	2512.471 74(14)	866.60	0.145E-22	R(45) x	63	2518.649 92(12)	1810.37	0.405E-22	P(35) D
29	2512.480 6	263.09	0.631E-22	P(25) R	64	2518.732 7	527.64	0.252E-22	P(35) P
30	2512.731 5	85.39	0.100E-22	P(14) V	65	2519.002 66(9)*	866.60	0.171E-20	P(45) A
31	2512.844 27(17)	2223.36	0.322E-23	P(62) B	66	2519.111 8	648.32	0.110E-22	R(40) T
32	2512.849 98(16)*	1849.42	0.551E-23	R(66) a	67	2519.686 9	680.72	0.961E-23	R(41) T
33	2513.095 8	367.75	0.324E-22	R(30) T	68	2519.687 48(12)	1781.19	0.453E-22	P(34) D
34	2513.265 81(9)*	1067.33	0.715E-21	P(50) A	69	2519.818 0	498.34	0.282E-22	P(34) P
35	2513.379 32(14)	1968.74	0.214E-22	P(40) D	70	2519.944 5	123.87	0.847E-22	P(17) R

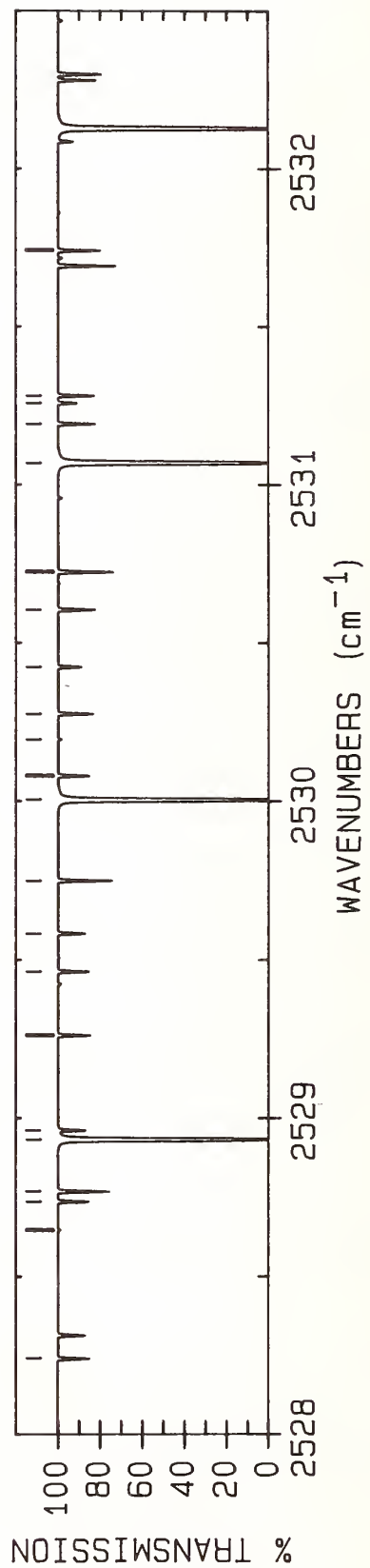
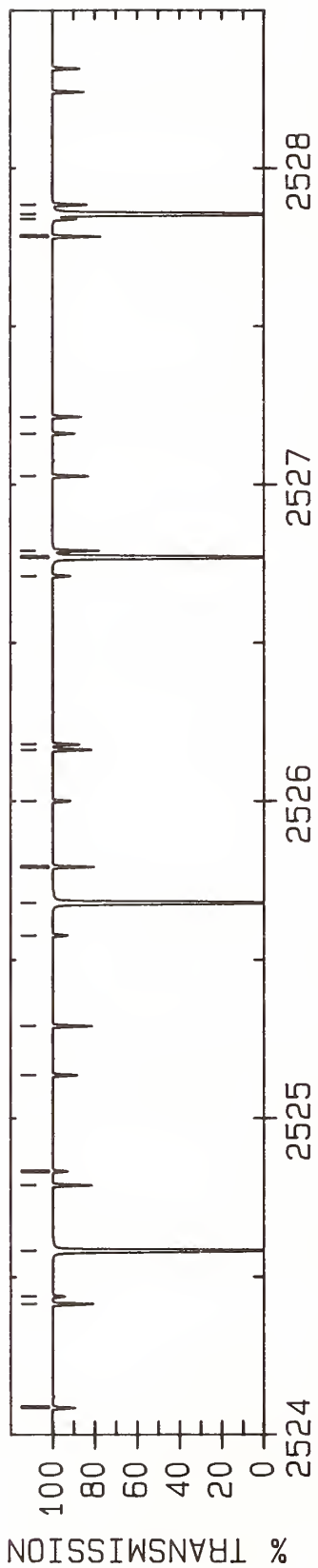
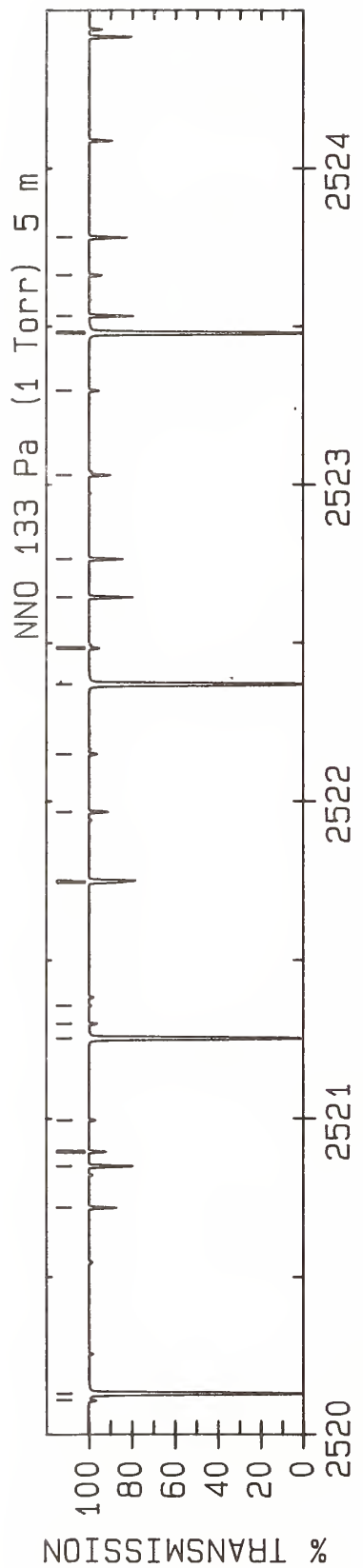

LINE #	WAVENUMBER(unc) (cm ⁻¹)	LOWER STATE (cm ⁻¹)	INTENSITY (cm/molecule)	ASSIGNMENT ROTATION BAND	LINE #	WAVENUMBER(unc) (cm ⁻¹)	LOWER STATE (cm ⁻¹)	INTENSITY (cm/molecule)	ASSIGNMENT ROTATION BAND
1	2520.109 23(6)	1924.97	0.124E-22	P(56) B	36	2526.000 79(6)	1699.17	0.340E-22	P(51) B
2	2520.131 37(9)*	828.95	0.201E-20	P(44) A	37	2526.162 7	44.53	0.735E-22	P(10) R
3	2520.719 45(12)	1752.85	0.505E-22	P(33) D	38	2526.178 9	340.10	0.503E-22	P(28) P
4	2520.850 8	110.11	0.853E-22	P(16) R	39	2526.711 39(5)	1701.27	0.337E-22	P(51) C
5	2520.896 1	469.88	0.315E-22	P(33) P	40	2526.771 03(8)*	620.59	0.479E-20	P(38) A
6	2520.995 58(7)	1927.48	0.123E-22	P(56) C	41	2526.791 78(13)	1600.25	0.869E-22	P(27) D
7	2521.253 80(9)*	792.14	0.235E-20	P(43) A	42	2527.026 9	36.44	0.688E-22	P(9) R
8	2521.299 49(6)	1878.14	0.153E-22	P(55) B	43	2527.161 04(5)	1656.51	0.410E-22	P(50) B
9	2521.356 57(30)	1335.69	0.497E-23	R(56) x	44	2527.213 8	316.65	0.544E-22	P(27) P
10	2521.745 77(12)	1725.33	0.560E-22	P(32) D	45	2527.783 66(13)	1577.73	0.935E-22	P(26) D
11	2521.751 1	97.16	0.852E-22	P(15) R	46	2527.839 31(5)	1658.53	0.407E-22	P(50) C
12	2521.967 0	442.25	0.349E-22	P(32) P	47	2527.855 34(8)*	588.78	0.545E-20	P(37) A
13	2522.148 76(6)	1880.57	0.152E-22	P(55) C	48	2527.885 1	29.15	0.634E-22	P(8) R
14	2522.369 94(9)*	756.16	0.274E-20	P(42) A	49	2528.241 5	294.04	0.585E-22	P(26) P
15	2522.483 80(6)	1832.15	0.188E-22	P(54) B	50	2528.646 8	8.13	0.525E-23	R(4) V
16	2522.645 4	85.01	0.844E-22	P(14) R	51	2528.737 3	22.67	0.572E-22	P(7) R
17	2522.766 43(13)	1698.65	0.618E-22	P(31) D	52	2528.769 70(13)	1556.05	0.999E-22	P(25) D
18	2523.030 8	415.46	0.386E-22	P(31) P	53	2528.933 23(8)*	557.81	0.616E-20	P(36) A
19	2523.296 98(6)	1834.50	0.186E-22	P(54) C	54	2528.962 07(5)	1616.62	0.489E-22	P(49) C
20	2523.479 75(9)*	721.01	0.317E-20	P(41) A	55	2529.262 0	272.26	0.625E-22	P(25) P
21	2523.533 7	73.68	0.828E-22	P(13) R	56	2529.463 32(5)	1573.69	0.590E-22	P(48) B
22	2523.662 14(6)	1786.99	0.230E-22	P(53) B	57	2529.583 5	17.00	0.505E-22	P(6) R
23	2523.781 39(13)	1672.80	0.678E-22	P(30) D	58	2529.749 88(12)	1535.19	0.106E-21	P(24) D
24	2523.781 89(43)	1481.09	0.326E-23	R(59) x	59	2530.004 67(8)*	527.67	0.694E-20	P(35) A
25	2524.087 3	389.50	0.424E-22	P(30) P	60	2530.079 63(5)	1575.55	0.585E-22	P(48) C
26	2524.416 0	63.15	0.805E-22	P(12) R	61	2530.194 0	17.08	0.704E-23	R(6) V
27	2524.440 18(5)	1789.25	0.228E-22	P(53) C	62	2530.275 3	251.32	0.665E-22	P(24) P
28	2524.583 22(8)*	686.70	0.365E-20	P(40) A	63	2530.423 5	12.15	0.431E-22	P(5) R
29	2524.790 62(13)	1647.79	0.741E-22	P(29) D	64	2530.605 29(5)	1533.53	0.702E-22	P(47) B
30	2524.834 48(6)	1742.67	0.281E-22	P(52) B	65	2530.724 17(12)	1515.18	0.112E-21	P(23) D
31	2525.136 7	364.38	0.463E-22	P(29) P	66	2531.069 65(8)*	498.37	0.778E-20	P(34) A
32	2525.292 4	53.44	0.774E-22	P(11) R	67	2531.191 95(5)	1535.31	0.697E-22	P(47) C
33	2525.578 33(5)	1744.84	0.278E-22	P(52) C	68	2531.257 6	8.10	0.351E-22	P(4) R
34	2525.680 32(8)*	653.23	0.419E-20	P(39) A	69	2531.281 3	231.22	0.703E-22	P(23) P
35	2525.794 09(13)	1623.60	0.805E-22	P(28) D	70	2531.741 11(5)	1494.20	0.833E-22	P(46) B

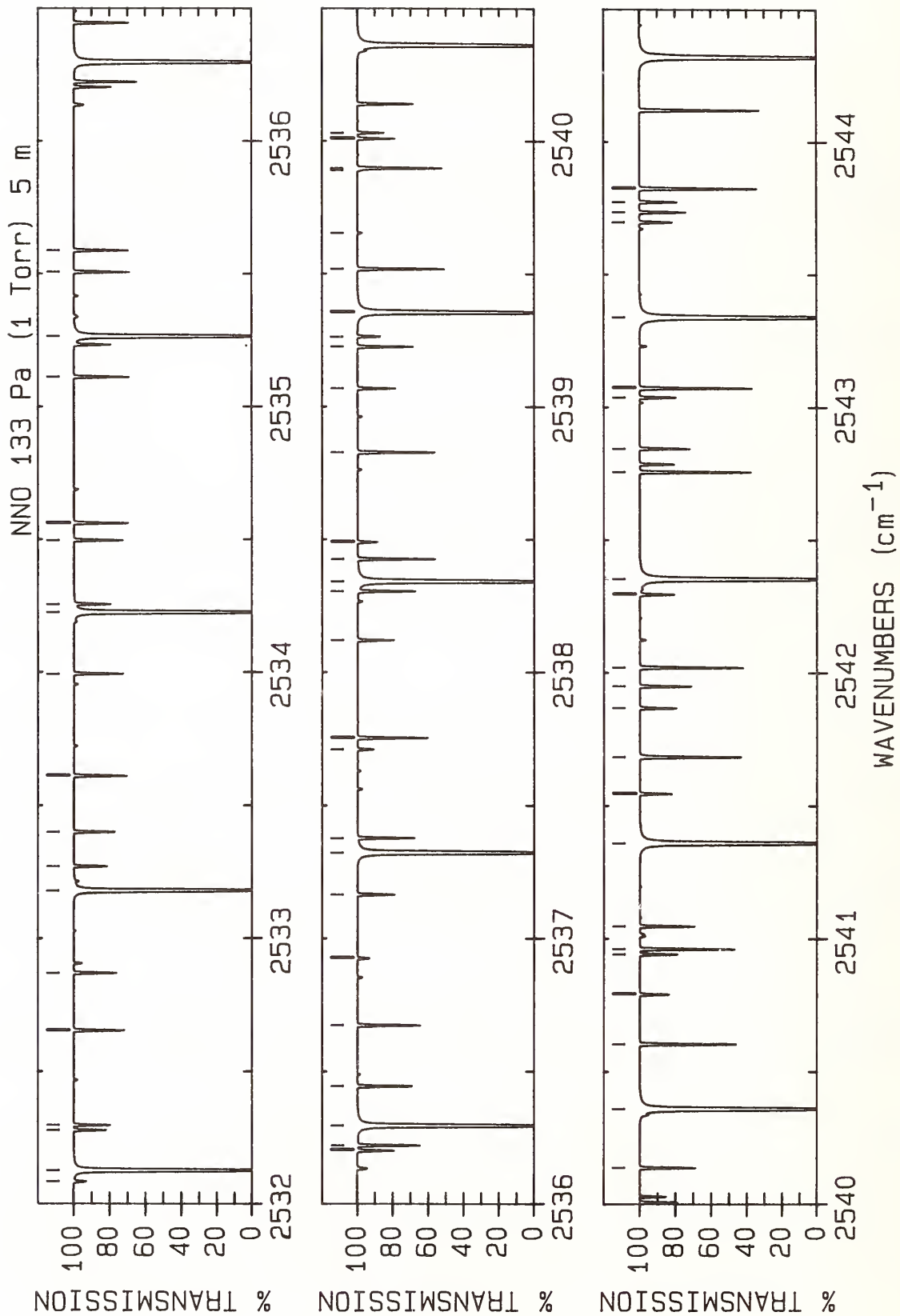

LINE #	WAVENUMBER(unc) (cm ⁻¹)	LOWER STATE (cm ⁻¹)	INTENSITY (cm ² /molecule)	ASSIGNMENT ROTATION BAND	LINE #	WAVENUMBER(unc) (cm ⁻¹)	LOWER STATE (cm ⁻¹)	INTENSITY (cm ² /molecule)	ASSIGNMENT ROTATION BAND
1	2532.085 5	4.86	0.268E-22	P(3) R	36	2538.828 65(4)	1277.04	0.209E-21	P(40) C
2	2532.128 15(8)*	469.91	0.867E-20	P(33) A	37	2539.068 1	100.55	0.868E-22	P(15) P
3	2532.280 1	211.96	0.739E-22	P(22) P	38	2539.224 61(11)	1372.52	0.137E-21	P(14) D
4	2532.298 99(5)	1495.90	0.826E-22	P(46) C	39	2539.263 3	12.15	0.519E-22	R(5) R
5	2532.655 02(12)	1477.64	0.123E-21	P(21) D	40	2539.354 94(7)*	294.06	0.161E-19	P(26) A
6	2532.870 78(5)	1455.70	0.982E-22	P(45) B	41	2539.518 33(5)	1242.25	0.241E-21	P(39) B
7	2533.180 16(8)*	442.28	0.962E-20	P(32) A	42	2539.653 8	154.51	0.103E-22	R(19) V
8	2533.271 6	193.53	0.771E-22	P(21) P	43	2539.890 13(13)	1890.51	0.108E-22	P(41) G
9	2533.400 72(5)	1457.34	0.975E-22	P(45) C	44	2539.897 87(4)	1243.48	0.240E-21	P(39) C
10	2533.611 53(11)	1460.12	0.128E-21	P(20) D	45	2540.008 7	87.98	0.861E-22	P(14) P
11	2533.994 27(5)	1418.04	0.115E-21	P(44) B	46	2540.030 3	17.00	0.591E-22	R(6) R
12	2534.225 65(8)*	415.49	0.106E-19	P(31) A	47	2540.138 98(11)	1360.84	0.135E-21	P(13) D
13	2534.255 9	175.94	0.800E-22	P(20) P	48	2540.361 06(7)*	272.28	0.172E-19	P(25) A
14	2534.497 11(5)	1419.61	0.115E-21	P(44) C	49	2540.604 33(5)	1209.60	0.275E-21	P(38) B
15	2534.562 07(11)	1443.43	0.132E-21	P(19) D	50	2540.791 3	22.67	0.657E-22	R(7) R
16	2535.111 56(5)	1381.21	0.135E-21	P(43) B	51	2540.942 0	76.25	0.847E-22	P(13) P
17	2535.264 62(8)*	389.53	0.117E-19	P(30) A	52	2540.961 57(4)	1210.77	0.274E-21	P(38) C
18	2535.506 62(11)	1427.58	0.135E-21	P(18) D	53	2541.047 26(12)	1349.99	0.131E-21	P(12) D
19	2535.588 13(5)	1382.71	0.134E-21	P(43) C	54	2541.360 57(7)*	251.34	0.183E-19	P(24) A
20	2536.202 6	143.27	0.845E-22	P(18) P	55	2541.546 1	29.15	0.717E-22	R(8) R
21	2536.222 62(5)	1345.22	0.157E-21	P(42) B	56	2541.684 04(5)	1177.78	0.313E-21	P(37) B
22	2536.297 05(8)*	364.41	0.128E-19	P(29) A	57	2541.868 0	65.36	0.825E-22	P(12) P
23	2536.445 17(11)	1412.57	0.137E-21	P(17) D	58	2541.949 45(12)	1339.98	0.126E-21	P(11) D
24	2536.673 75(5)	1346.65	0.156E-21	P(42) C	59	2542.019 73(4)	1178.89	0.311E-21	P(37) C
25	2536.925 5	2.43	0.272E-22	R(2) R	60	2542.294 8	36.44	0.769E-22	R(9) R
26	2537.165 1	128.19	0.859E-22	P(17) P	61	2542.353 45(7)*	231.24	0.194E-19	P(23) A
27	2537.322 92(8)*	340.12	0.139E-19	P(28) A	62	2542.757 42(5)	1146.80	0.354E-21	P(36) B
28	2537.377 69(11)	1398.38	0.138E-21	P(16) D	63	2542.845 53(13)	1330.80	0.120E-21	P(10) D
29	2537.710 9	4.86	0.358E-22	R(3) R	64	2543.037 5	44.53	0.813E-22	R(10) R
30	2537.753 93(5)	1311.42	0.181E-21	P(41) C	65	2543.072 31(4)	1147.85	0.352E-21	P(36) C
31	2538.120 2	113.95	0.867E-22	P(16) P	66	2543.339 71(7)*	211.97	0.203E-19	P(22) A
32	2538.304 18(11)	1385.04	0.138E-21	P(15) D	67	2543.698 0	46.09	0.755E-22	P(10) P
33	2538.342 22(7)*	316.67	0.150E-19	P(27) A	68	2543.735 49(13)	1322.45	0.113E-21	P(9) D
34	2538.426 03(5)	1275.74	0.210E-21	P(40) B	69	2543.774 0	53.44	0.850E-22	R(11) R
35	2538.490 1	8.10	0.441E-22	R(4) R	70	2543.824 46(5)	1116.65	0.399E-21	P(35) B

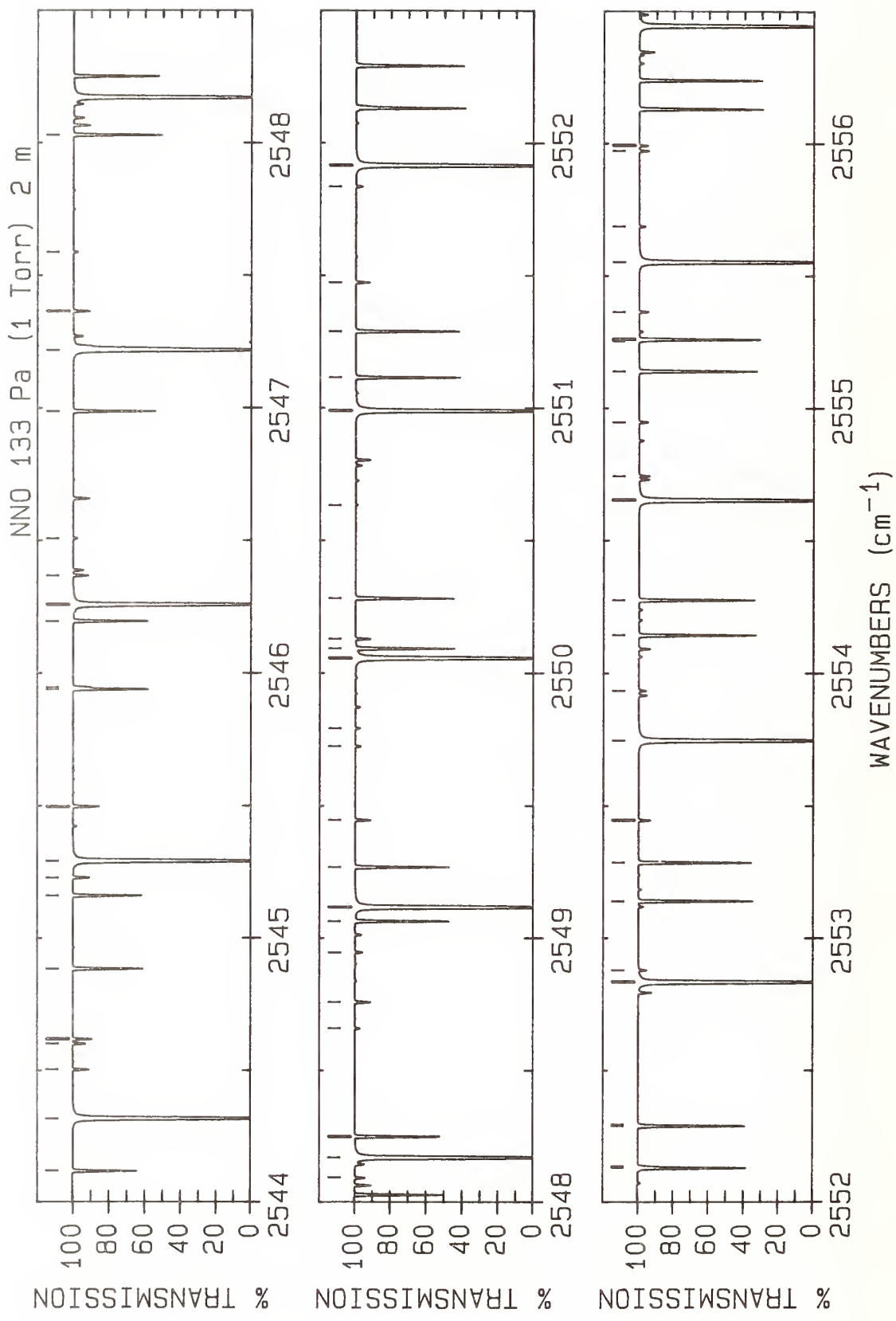

LINE #	WAVENUMBER(unc) (cm ⁻¹)	LOWER STATE (cm ⁻¹)	INTENSITY (cm/molecule)	ASSIGNMENT ROTATION BAND	LINE #	WAVENUMBER(unc) (cm ⁻¹)	LOWER STATE (cm ⁻¹)	INTENSITY (cm/molecule)	ASSIGNMENT ROTATION BAND
1	2544.119 29(4)	1117.64	0.397E-21	P(35) C	36	2550.092 79(4)	953.32	0.732E-21	P(29) B
2	2544.319 31(7)*	193.54	0.213E-19	P(21) A	37	2550.128 6	170.01	0.846E-22	R(20) R
3	2544.504 4	63.15	0.879E-22	R(12) R	38	2550.282 25(4)	954.01	0.730E-21	P(29) C
4	2544.602 0	37.71	0.708E-22	P(9) P	39	2550.633 83(16)	1285.74	0.150E-22	P(1) D
5	2544.619 33(14)	1314.94	0.104E-21	P(8) D	40	2550.989 58(7)*	87.98	0.237E-19	P(14) A
6	2544.885 14(5)	1087.34	0.447E-21	P(34) B	41	2551.115 06(4)	929.02	0.796E-21	P(28) B
7	2545.160 65(4)	1088.28	0.445E-21	P(34) C	42	2551.289 37(4)	929.66	0.794E-21	P(28) C
8	2545.228 8	73.68	0.899E-22	R(13) R	43	2551.473 8	204.82	0.783E-22	R(22) R
9	2545.292 26(7)*	175.95	0.221E-19	P(20) A	44	2551.834 98(13)	1558.45	0.401E-22	P(30) G
10	2545.497 03(15)	1308.27	0.939E-22	P(7) D	45	2551.915 64(7)*	76.25	0.233E-19	P(13) A
11	2545.498 8	30.17	0.653E-22	P(8) P	46	2552.130 89(4)	905.56	0.860E-21	P(27) B
12	2545.939 46(5)	1058.86	0.498E-21	P(33) B	47	2552.137 3	223.43	0.746E-22	R(23) R
13	2545.947 0	85.01	0.912E-22	R(14) R	48	2552.290 72(4)	906.16	0.858E-21	P(27) C
14	2546.196 36(4)	1059.75	0.496E-21	P(33) C	49	2552.296 65(16)	1284.90	0.151E-22	R(0) D
15	2546.258 54(7)*	159.20	0.227E-19	P(19) A	50	2552.834 98(7)*	65.36	0.227E-19	P(12) A
16	2546.368 57(15)	1302.43	0.828E-22	P(6) D	51	2552.879 61(13)	1533.28	0.438E-22	P(29) G
17	2546.508 32(13)	1696.84	0.238E-22	P(35) G	52	2553.139 40(8)	1768.20	0.178E-22	P(37) E
18	2546.987 40(5)	1031.22	0.553E-21	P(32) B	53	2553.140 27(4)	882.94	0.925E-21	P(26) B
19	2547.218 14(7)*	143.28	0.233E-19	P(18) A	54	2553.286 27(4)	883.50	0.923E-21	P(26) C
20	2547.365 2	110.11	0.915E-22	R(16) R	55	2553.446 2	263.09	0.667E-22	R(25) R
21	2547.587 41(13)	1667.49	0.267E-22	P(34) G	56	2553.747 58(7)*	55.31	0.219E-19	P(11) A
22	2548.028 94(5)	1004.42	0.610E-21	P(31) B	57	2553.934 70(16)	1287.41	0.447E-22	R(2) D
23	2548.093 19(16)	1293.25	0.578E-22	P(4) D	58	2554.143 17(4)	861.16	0.989E-21	P(25) B
24	2548.171 06(7)*	128.20	0.237E-19	P(17) A	59	2554.276 01(4)	861.67	0.987E-21	P(25) C
25	2548.250 74(4)	1005.20	0.608E-21	P(31) C	60	2554.653 42(7)*	46.09	0.208E-19	P(10) A
26	2548.659 64(13)	1638.97	0.298E-22	P(33) G	61	2554.744 43(15)	1289.91	0.589E-22	R(3) D
27	2548.759 0	138.44	0.892E-22	R(18) R	62	2554.948 07(13)	1485.45	0.515E-22	P(27) G
28	2548.946 25(16)	1289.91	0.441E-22	P(3) D	63	2555.139 59(4)	840.21	0.105E-20	P(24) B
29	2549.064 08(4)	978.45	0.670E-21	P(30) B	64	2555.253 69(8)	1706.91	0.227E-22	P(35) E
30	2549.117 27(7)*	113.96	0.239E-19	P(16) A	65	2555.259 91(3)	840.68	0.105E-20	P(24) C
31	2549.269 36(4)	979.18	0.668E-21	P(30) C	66	2555.364 3	328.64	0.542E-22	R(28) R
32	2549.446 8	153.82	0.872E-22	R(19) R	67	2555.552 52(7)*	37.71	0.195E-19	P(9) A
33	2549.724 99(13)	1611.29	0.330E-22	P(32) G	68	2555.686 5	5.03	0.371E-22	R(3) P
34	2549.793 13(16)	1287.41	0.297E-22	P(2) D	69	2555.971 88(12)	1462.80	0.554E-22	P(26) G
35	2550.056 78(7)*	100.55	0.239E-19	P(15) A	70	2555.991 7	352.10	0.500E-22	R(29) R

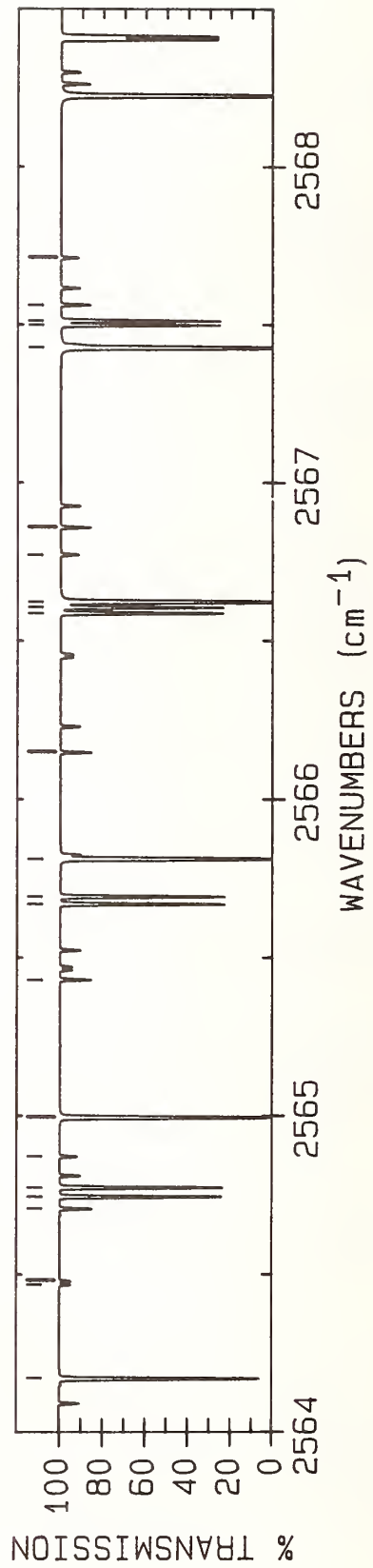
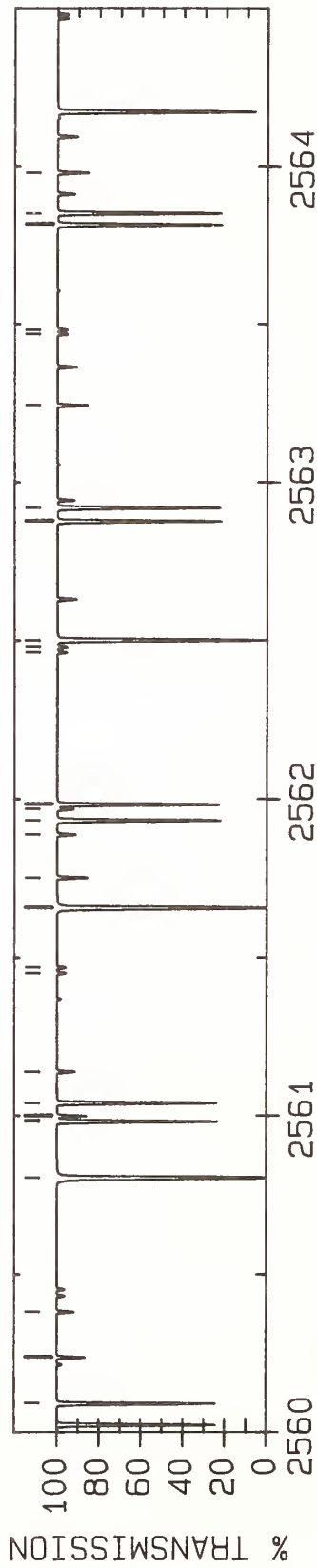
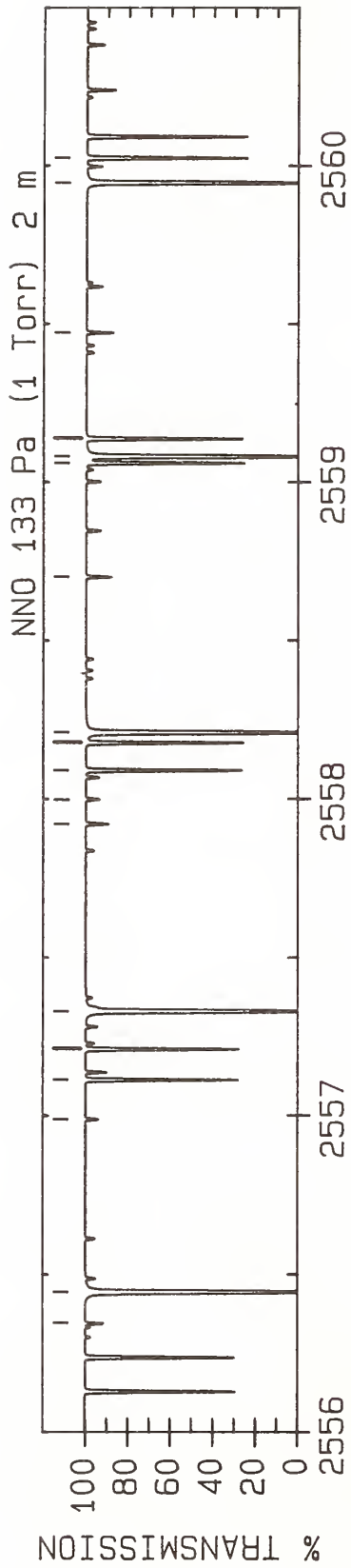

LINE #	WAVENUMBER(unc) (cm ⁻¹)	LOWER STATE (cm ⁻¹)	INTENSITY (cm/molecule)	ASSIGNMENT ROTATION BAND	LINE #	WAVENUMBER(unc) (cm ⁻¹)	LOWER STATE (cm ⁻¹)	INTENSITY (cm/molecule)	ASSIGNMENT ROTATION BAND
1	2556.345 27(15)	1297.42	0.852E-22	R(5) D	36	2562.462 62(8)	1518.81	0.453E-22	P(28) E
2	2556.444 85(7)*	30.17	0.180E-19	P(8) A	37	2562.478 02(8)	1518.77	0.454E-22	P(28) F
3	2556.988 73(12)	1440.98	0.593E-22	P(25) G	38	2562.500 75(11)	1360.84	0.146E-21	R(13) D
4	2557.112 95(3)	800.83	0.117E-20	P(22) B	39	2562.501 31(7)*	0.84	0.260E-20	P(1) A
5	2557.210 13(3)	801.23	0.117E-20	P(22) C	40	2562.876 45(4)	702.77	0.137E-20	P(16) B
6	2557.330 41(7)*	23.46	0.163E-19	P(7) A	41	2562.919 06(4)	702.99	0.137E-20	P(16) C
7	2557.921 31(13)	1308.27	0.108E-21	R(7) D	42	2563.242 35(11)	1372.52	0.148E-21	R(14) D
8	2557.998 60(12)	1420.00	0.630E-22	P(24) G	43	2563.468 15(8)	1495.29	0.490E-22	P(27) E
9	2558.089 87(3)	782.39	0.122E-20	P(21) B	44	2563.481 60(8)	1495.26	0.491E-22	P(27) F
10	2558.176 42(3)	782.76	0.122E-20	P(21) C	45	2563.814 10(4)	689.36	0.137E-20	P(15) B
11	2558.209 20(7)*	17.60	0.144E-19	P(6) A	46	2563.849 73(4)	689.55	0.137E-20	P(15) C
12	2558.700 03(13)	1314.94	0.117E-21	R(8) D	47	2563.977 78(11)	1385.04	0.149E-21	R(15) D
13	2559.060 27(3)	764.79	0.126E-20	P(20) B	48	2564.170 54(7)*	0.00	0.261E-20	R(0) A
14	2559.081 20(7)*	12.57	0.123E-19	P(5) A	49	2564.467 60(8)	1472.61	0.527E-22	P(26) E
15	2559.136 81(3)	765.12	0.126E-20	P(20) C	50	2564.479 29(8)	1472.58	0.527E-22	P(26) F
16	2559.472 55(12)	1322.45	0.126E-21	R(9) D	51	2564.707 06(11)	1398.38	0.148E-21	R(16) D
17	2559.946 42(7)*	8.38	0.100E-19	P(4) A	52	2564.745 18(4)	676.79	0.136E-20	P(14) B
18	2560.024 13(3)	748.03	0.130E-20	P(19) B	53	2564.774 41(4)	676.95	0.136E-20	P(14) C
19	2560.091 28(3)	748.33	0.130E-20	P(19) C	54	2564.871 62(12)	1296.61	0.816E-22	P(17) G
20	2560.238 88(12)	1330.80	0.133E-21	R(10) D	55	2564.994 94(7)*	0.84	0.520E-20	R(1) A
21	2560.382 2	37.71	0.792E-22	R(9) P	56	2565.430 18(11)	1412.57	0.147E-21	R(17) D
22	2560.804 85(7)*	5.03	0.764E-20	P(3) A	57	2565.669 68(4)	665.05	0.134E-20	P(13) B
23	2560.981 46(3)	732.11	0.134E-20	P(18) B	58	2565.693 11(4)	665.20	0.133E-20	P(13) C
24	2560.986 28(12)	1362.08	0.732E-22	P(21) G	59	2565.812 51(7)*	2.51	0.775E-20	R(2) A
25	2560.999 02(11)	1339.98	0.139E-21	R(11) D	60	2566.147 17(11)	1427.58	0.144E-21	R(18) D
26	2561.039 82(3)	732.38	0.133E-20	P(18) C	61	2566.587 59(4)	654.15	0.130E-20	P(12) B
27	2561.138 9	46.09	0.837E-22	R(10) P	62	2566.605 79(4)	654.28	0.130E-20	P(12) C
28	2561.451 00(8)	1543.16	0.417E-22	P(29) E	63	2566.623 27(7)*	5.03	0.102E-19	R(3) A
29	2561.468 56(8)	1543.12	0.417E-22	P(29) F	64	2566.772 02(13)	1268.90	0.824E-22	P(15) G
30	2561.656 48(7)*	2.51	0.516E-20	P(2) A	65	2566.858 02(12)	1443.43	0.140E-21	R(19) D
31	2561.752 98(11)	1349.99	0.143E-21	R(12) D	66	2567.427 20(7)*	8.38	0.126E-19	R(4) A
32	2561.888 3	55.30	0.873E-22	R(11) P	67	2567.498 91(5)	644.10	0.125E-20	P(11) B
33	2561.932 23(3)	717.02	0.136E-20	P(17) B	68	2567.512 46(5)	644.20	0.125E-20	P(11) C
34	2561.968 16(12)	1344.45	0.760E-22	P(20) G	69	2567.562 76(12)	1460.12	0.136E-21	R(20) D
35	2561.982 42(3)	717.26	0.135E-20	P(17) C	70	2567.711 61(13)	1256.31	0.818E-22	P(14) G

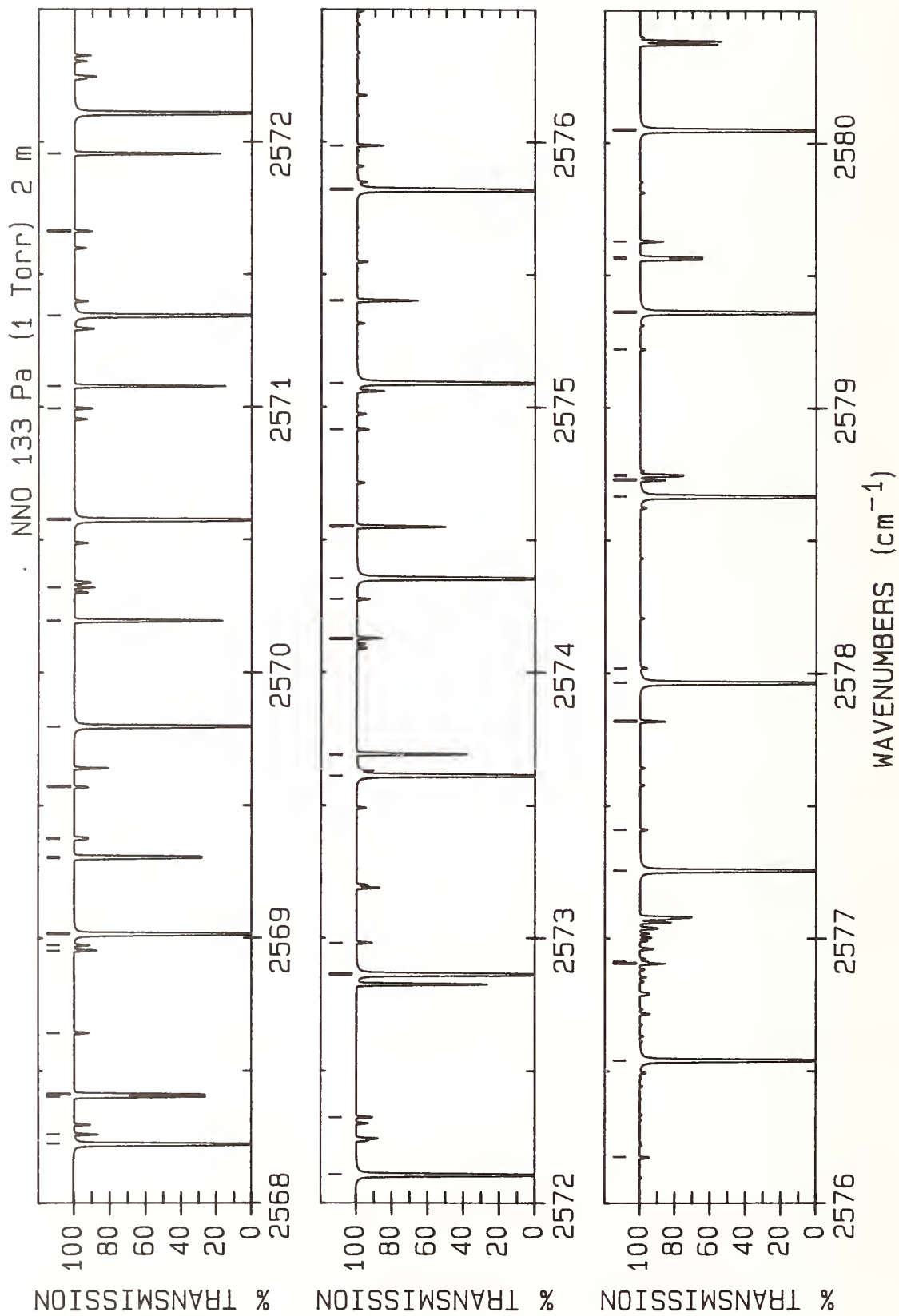

LINE #	WAVENUMBER(cm^{-1})	LOWER STATE (cm^{-1})	INTENSITY ($\text{cm}/\text{molecule}$)	ASSIGNMENT ROTATION BAND	LINE #	WAVENUMBER(cm^{-1})	LOWER STATE (cm^{-1})	INTENSITY ($\text{cm}/\text{molecule}$)	ASSIGNMENT ROTATION BAND
1	2568.224 30(7)*	12.57	0.148E-19	R(5) A	36	2574.128 80(8)	1292.01	0.776E-22	F P(16)
2	2568.261 39(12)	1477.64	0.131E-21	R(21) D	37	2574.276 77(12)	1672.80	0.715E-22	D R(30)
3	2568.403 62(5)	634.88	0.118E-20	P(10) B	38	2574.355 11(7)*	76.25	0.253E-19	A R(13)
4	2568.404 49(8)	1390.30	0.665E-22	P(22) E	39	2574.548 11(6)	593.81	0.391E-21	C P(3)
5	2568.410 80(8)	1390.28	0.665E-22	P(22) F	40	2574.551 18(6)	593.80	0.391E-21	B P(3)
6	2568.413 10(5)	634.96	0.118E-20	P(10) C	41	2574.915 23(12)	1698.65	0.651E-22	D R(31)
7	2568.644 14(13)	1244.55	0.805E-22	P(13) G	42	2575.090 69(7)*	87.98	0.257E-19	A R(14)
8	2568.953 92(12)	1495.99	0.125E-21	R(22) D	43	2575.400 24(6)	591.29	0.223E-21	C P(2)
9	2568.973 5	193.53	0.820E-22	R(21) P	44	2575.402 85(6)	591.28	0.223E-21	B P(2)
10	2569.014 58(7)*	17.60	0.168E-19	R(6) A	45	2575.819 44(7)*	100.55	0.258E-19	A R(15)
11	2569.301 72(5)	626.49	0.111E-20	P(9) B	46	2575.985 36(8)	1265.97	0.767E-22	E P(14)
12	2569.307 70(5)	626.56	0.111E-20	P(9) C	47	2575.986 59(8)	1265.96	0.767E-22	F P(14)
13	2569.373 47(8)	1371.82	0.694E-22	P(21) E	48	2576.174 46(12)	1752.85	0.532E-22	D R(33)
14	2569.378 79(8)	1371.80	0.694E-22	P(21) F	49	2576.541 34(7)*	113.96	0.256E-19	A R(16)
15	2569.569 57(13)	1233.63	0.784E-22	P(12) G	50	2576.905 45(8)	1254.20	0.752E-22	E P(13)
16	2569.798 02(7)*	23.46	0.187E-19	R(7) A	51	2576.906 40(8)	1254.20	0.752E-22	F P(13)
17	2570.193 20(5)	618.95	0.102E-20	P(8) B	52	2576.913 05(5)	606.41	0.427E-22	C Q(6)
18	2570.196 26(5)	619.00	0.102E-20	P(8) C	53	2577.256 41(7)*	128.20	0.253E-19	A R(17)
19	2570.320 77(13)	1535.19	0.112E-21	R(24) D	54	2577.410 29(13)	1810.37	0.426E-22	D R(35)
20	2570.574 63(7)*	30.17	0.204E-19	R(8) A	55	2577.819 42(8)	1243.28	0.729E-22	E P(12)
21	2570.995 12(13)	1556.05	0.106E-21	R(25) D	56	2577.820 14(8)	1243.28	0.729E-22	F P(12)
22	2571.078 07(5)	612.24	0.917E-21	P(7) B	57	2577.964 65(7)*	143.28	0.249E-19	A R(18)
23	2571.078 77(5)	612.29	0.917E-21	P(7) C	58	2578.019 49(13)	1840.38	0.378E-22	D R(36)
24	2571.344 40(7)*	37.71	0.218E-19	R(9) A	59	2578.666 06(7)*	159.20	0.242E-19	A R(19)
25	2571.663 43(13)	1577.73	0.987E-22	R(26) D	60	2578.727 27(8)	1233.20	0.699E-22	E P(11)
26	2571.955 22(6)	606.41	0.803E-21	P(6) C	61	2578.727 79(8)	1233.20	0.699E-22	F P(11)
27	2571.956 30(6)	606.37	0.803E-21	P(6) B	62	2578.742 94(6)	589.61	0.225E-21	B R(1)
28	2572.107 33(7)*	46.09	0.230E-19	R(10) A	63	2578.747 79(6)	589.61	0.225E-21	C R(1)
29	2572.325 74(13)	1600.25	0.918E-22	R(27) D	64	2579.220 64(14)	1902.90	0.294E-22	D R(38)
30	2572.863 43(7)*	55.31	0.240E-19	R(11) A	65	2579.360 63(7)*	175.95	0.235E-19	A R(20)
31	2572.982 05(13)	1623.60	0.849E-22	R(28) D	66	2579.561 29(6)	591.28	0.396E-21	B R(2)
32	2573.612 69(7)*	65.36	0.248E-19	R(12) A	67	2579.569 41(6)	591.29	0.396E-21	C R(2)
33	2573.689 89(6)	597.17	0.540E-21	P(4) C	68	2579.628 98(8)	1223.96	0.660E-22	E P(10)
34	2573.692 86(6)	597.15	0.540E-21	P(4) B	69	2579.629 36(8)	1223.96	0.660E-22	F P(10)
35	2574.126 81(8)	1292.01	0.776E-22	P(16) E	70	2580.048 37(7)*	193.54	0.226E-19	A R(21)

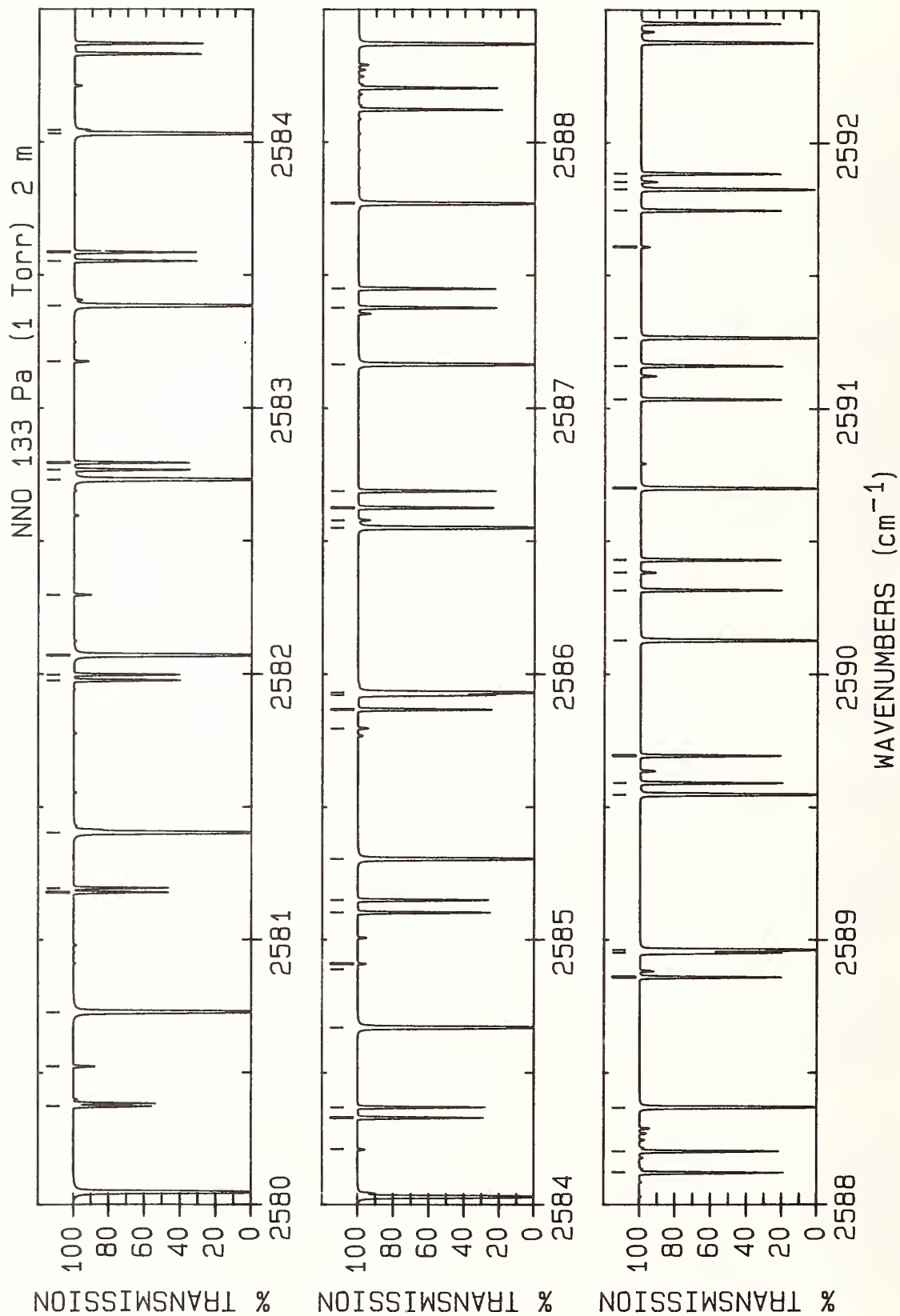

LINE #	WAVENUMBER(unc) (cm ⁻¹)	LOWER STATE (cm ⁻¹)	INTENSITY (cm/molecule)	ASSIGNMENT ROTATION BAND	LINE #	WAVENUMBER(unc) (cm ⁻¹)	LOWER STATE (cm ⁻¹)	INTENSITY (cm/molecule)	ASSIGNMENT ROTATION BAND
1	2580.372 97(6)	593.80	0.551E-21	R(3)	36	2585.922 21(4)	634.96	0.131E-20	R(10)
2	2580.524 56(8)	1215.56	0.613E-22	P(9)	37	2585.931 47(8)*	389.53	0.123E-19	R(30)
3	2580.524 82(8)	1215.55	0.613E-22	P(9)	38	2586.551 18(8)*	415.49	0.112E-19	R(31)
4	2580.729 29(7)*	211.97	0.216E-19	R(22)	39	2586.579 34(14)	1191.65	0.645E-22	R(7)
5	2581.177 97(6)	597.15	0.694E-21	R(4)	40	2586.625 78(4)	644.10	0.137E-20	R(11)
6	2581.194 31(6)	597.17	0.694E-21	R(4)	41	2586.688 79(4)	644.20	0.137E-20	R(11)
7	2581.403 39(7)*	231.24	0.205E-19	R(23)	42	2587.164 12(8)*	442.28	0.101E-19	R(32)
8	2581.976 29(5)	601.34	0.826E-21	R(5)	43	2587.377 27(4)	654.15	0.142E-20	R(12)
9	2581.997 59(5)	601.37	0.826E-21	R(5)	44	2587.449 25(4)	654.28	0.142E-20	R(12)
10	2582.070 67(7)*	251.34	0.194E-19	R(24)	45	2587.770 29(8)*	469.91	0.913E-20	R(33)
11	2582.297 31(8)	1201.27	0.494E-22	P(7)	46	2588.122 06(4)	665.05	0.145E-20	R(13)
12	2582.297 42(8)	1201.27	0.494E-22	P(7)	47	2588.122 25(13)	1205.92	0.753E-22	R(9)
13	2582.731 14(7)*	272.28	0.182E-19	R(25)	48	2588.203 60(4)	665.20	0.145E-20	R(13)
14	2582.767 93(5)	606.37	0.948E-21	R(6)	49	2588.369 71(8)*	498.37	0.819E-20	R(34)
15	2582.794 75(5)	606.41	0.948E-21	R(6)	50	2588.860 15(4)	676.79	0.147E-20	R(14)
16	2583.174 48(8)	1195.39	0.422E-22	P(6)	51	2588.951 84(4)	676.95	0.147E-20	R(14)
17	2583.174 54(8)	1195.39	0.422E-22	P(6)	52	2588.962 39(8)*	527.67	0.730E-20	R(35)
18	2583.384 80(8)*	294.06	0.170E-19	R(26)	53	2589.548 34(8)*	557.81	0.649E-20	R(36)
19	2583.552 88(5)	612.24	0.106E-20	R(7)	54	2589.591 55(3)	689.36	0.148E-20	R(15)
20	2583.585 79(5)	612.29	0.106E-20	R(7)	55	2589.693 98(3)	689.55	0.148E-20	R(15)
21	2584.031 66(8)*	316.67	0.158E-19	R(27)	56	2590.127 56(8)*	588.78	0.573E-20	R(37)
22	2584.045 50(8)	1190.35	0.340E-22	P(5)	57	2590.316 25(3)	702.77	0.147E-20	R(16)
23	2584.045 53(8)	1190.35	0.340E-22	P(5)	58	2590.382 41(13)	1233.63	0.856E-22	R(12)
24	2584.210 86(14)	1176.53	0.433E-22	R(4)	59	2590.430 01(3)	702.99	0.147E-20	R(16)
25	2584.331 15(5)	618.95	0.116E-20	R(8)	60	2590.700 07(8)*	620.59	0.504E-20	R(38)
26	2584.370 72(5)	619.00	0.116E-20	R(8)	61	2591.034 24(3)	717.02	0.145E-20	R(17)
27	2584.671 72(8)*	340.12	0.146E-19	R(28)	62	2591.159 95(3)	717.26	0.145E-20	R(17)
28	2584.890 56(24)	2265.33	0.637E-23	R(48)	63	2591.265 88(9)*	653.23	0.441E-20	R(39)
29	2584.910 37(8)	1186.15	0.248E-22	P(4)	64	2591.607 67(8)	1182.79	0.253E-22	R(3)
30	2584.910 39(8)	1186.15	0.248E-22	P(4)	65	2591.607 68(8)	1182.79	0.253E-22	R(3)
31	2585.102 72(5)	626.49	0.124E-20	R(9)	66	2591.745 54(3)	732.11	0.143E-20	R(18)
32	2585.149 52(5)	626.56	0.124E-20	R(9)	67	2591.825 01(9)*	686.70	0.385E-20	R(40)
33	2585.304 99(8)*	364.41	0.134E-19	R(29)	68	2591.853 01(12)	1256.31	0.885E-22	R(14)
34	2585.797 06(14)	1185.77	0.580E-22	R(6)	69	2591.883 80(3)	732.38	0.142E-20	R(18)
35	2585.867 60(4)	634.88	0.131E-20	R(10)					

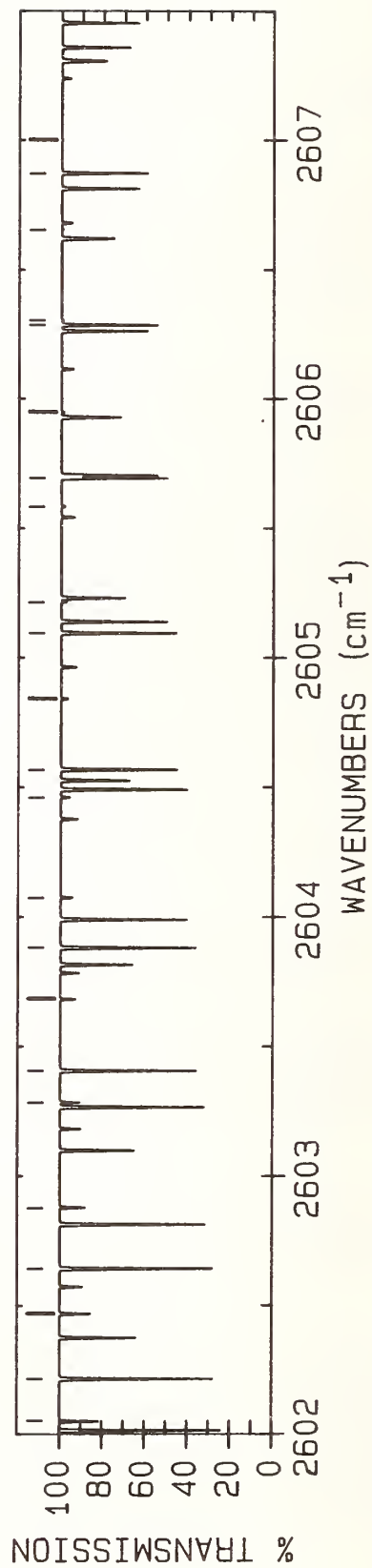
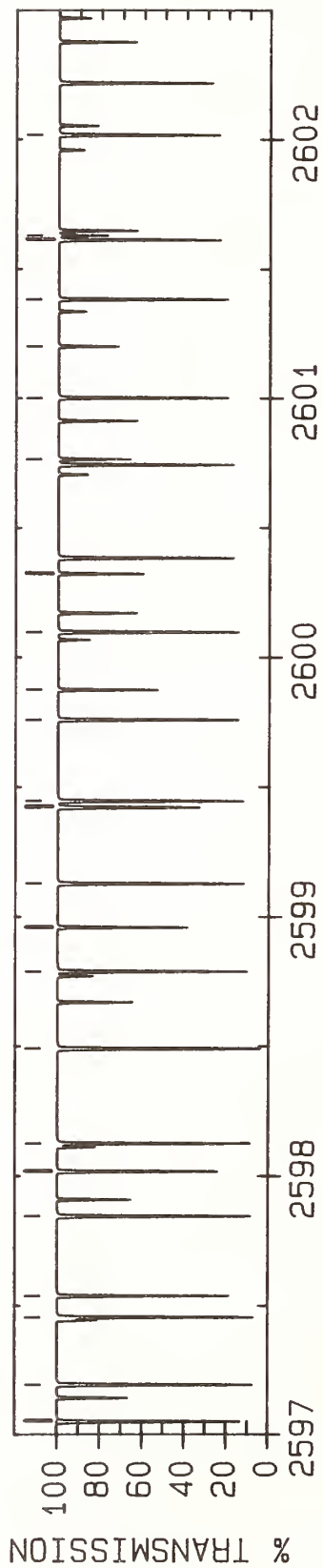
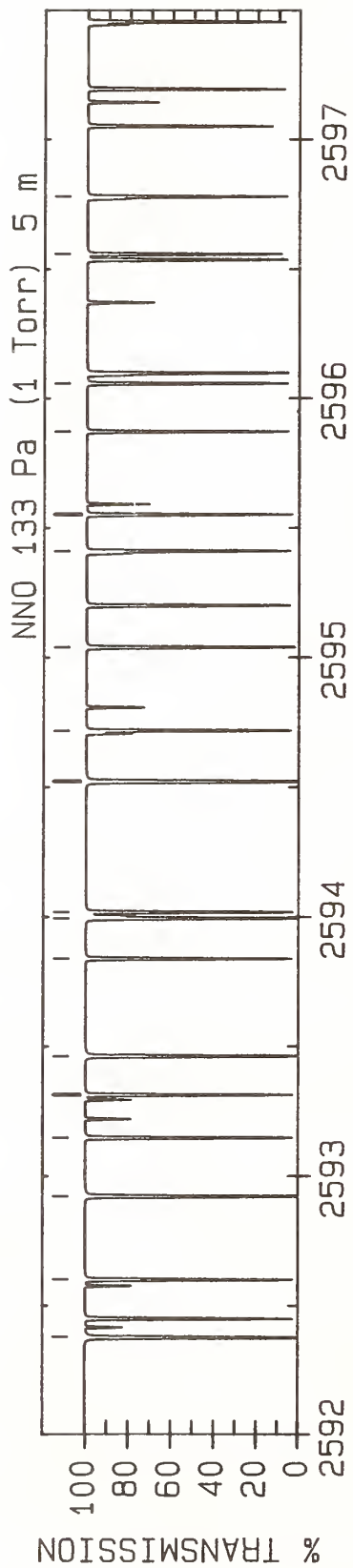

LINE #	WAVENUMBER(unc) (cm ⁻¹)	LOWER STATE (cm ⁻¹)	INTENSITY (cm/molecule)	ASSIGNMENT ROTATION BAND	LINE #	WAVENUMBER(unc) (cm ⁻¹)	LOWER STATE (cm ⁻¹)	INTENSITY (cm/molecule)	ASSIGNMENT ROTATION BAND
1	2592.377 46(9)*	721.01	0.333E-20	R(41) A	36	2599.446 32(4)	954.01	0.770E-21	R(29) C
2	2592.601 57(3)	748.33	0.139E-20	R(19) C	37	2599.759 18(5)	978.45	0.706E-21	R(30) B
3	2592.923 25(9)*	756.16	0.288E-20	R(42) A	38	2599.874 66(10)*	1335.69	0.229E-21	R(56) A
4	2593.148 05(3)	764.79	0.135E-20	R(20) B	39	2600.097 72(4)	979.18	0.704E-21	R(30) C
5	2593.313 26(3)	765.12	0.134E-20	R(20) C	40	2600.322 76(10)*	1383.33	0.185E-21	R(57) A
6	2593.462 39(9)*	792.14	0.247E-20	R(43) A	41	2600.764 54(10)*	1431.79	0.148E-21	R(58) A
7	2593.839 26(3)	782.39	0.130E-20	R(21) B	42	2601.001 30(5)	1031.22	0.582E-21	R(32) B
8	2593.994 91(9)*	828.95	0.211E-20	R(44) A	43	2601.200 02(10)*	1481.09	0.119E-21	R(59) A
9	2594.018 88(3)	782.76	0.129E-20	R(21) C	44	2601.382 63(4)	1032.06	0.580E-21	R(32) C
10	2594.520 81(9)*	866.60	0.180E-20	R(45) A	45	2601.612 38(5)	1058.86	0.525E-21	R(33) B
11	2594.523 78(4)	800.83	0.124E-20	R(22) B	46	2601.629 24(10)*	1531.22	0.947E-22	R(60) A
12	2594.718 43(3)	801.23	0.124E-20	R(22) C	47	2602.016 18(4)	1059.75	0.522E-21	R(33) C
13	2595.040 12(9)*	905.08	0.153E-20	R(46) A	48	2602.052 23(10)*	1582.18	0.751E-22	R(61) A
14	2595.411 93(4)	820.54	0.118E-20	R(23) C	49	2602.216 80(5)	1087.34	0.470E-21	R(34) B
15	2595.552 84(9)*	944.39	0.129E-20	R(47) A	50	2602.469 01(10)*	1633.97	0.594E-22	R(62) A
16	2595.872 73(4)	840.21	0.111E-20	R(24) B	51	2602.643 80(4)	1088.28	0.468E-21	R(34) C
17	2596.059 01(9)*	984.54	0.108E-20	R(48) A	52	2602.879 63(10)*	1686.59	0.467E-22	R(63) A
18	2596.558 63(9)*	1025.52	0.905E-21	R(49) A	53	2603.284 12(10)*	1740.04	0.366E-22	R(64) A
19	2596.780 80(4)	861.67	0.104E-20	R(25) C	54	2603.405 73(5)	1146.80	0.373E-21	R(36) B
20	2597.051 73(9)*	1067.33	0.753E-21	R(50) A	55	2603.682 51(10)*	1794.32	0.285E-22	R(65) A
21	2597.194 93(4)	882.94	0.977E-21	R(26) B	56	2603.881 35(4)	1147.85	0.371E-21	R(36) C
22	2597.456 20(4)	883.50	0.975E-21	R(26) C	57	2604.074 85(11)*	1849.42	0.222E-22	R(66) A
23	2597.538 34(9)*	1109.98	0.625E-21	R(51) A	58	2604.461 16(12)*	1905.36	0.172E-22	R(67) A
24	2597.846 01(4)	905.56	0.908E-21	R(27) B	59	2604.568 15(5)	1209.60	0.290E-21	R(38) B
25	2598.018 46(9)*	1153.46	0.515E-21	R(52) A	60	2604.841 50(14)*	1962.12	0.132E-22	R(68) A
26	2598.125 57(4)	906.16	0.906E-21	R(27) C	61	2605.095 41(4)	1210.77	0.288E-21	R(38) C
27	2598.490 41(4)	929.02	0.840E-21	R(28) B	62	2605.215 91(15)*	2019.71	0.101E-22	R(69) A
28	2598.492 13(9)*	1197.77	0.423E-21	R(53) A	63	2605.584 43(18)*	2078.13	0.773E-23	R(70) A
29	2598.788 94(4)	929.66	0.837E-21	R(28) C	64	2605.693 68(5)	1243.48	0.252E-21	R(39) C
30	2598.959 37(9)*	1242.91	0.346E-21	R(54) A	65	2605.947 09(21)*	2137.38	0.588E-23	R(71) A
31	2599.128 13(5)	953.32	0.772E-21	R(29) B	66	2606.286 14(5)	1277.04	0.220E-21	R(40) C
32	2599.420 20(9)*	1288.88	0.282E-21	R(55) A	67	2606.303 96(24)*	2197.45	0.445E-23	R(72) A
33	2599.423 04(13)	1440.98	0.627E-22	R(25) G	68	2606.655 08(28)*	2258.36	0.336E-23	R(73) A
34	2599.423 48(8)	1254.20	0.820E-22	R(13) E	69	2606.872 81(5)	1311.42	0.190E-21	R(41) C
35	2599.423 60(8)	1254.20	0.820E-22	R(13) F	70	2607.000 49(32)*	2320.08	0.252E-23	R(74) A

ATLAS OF N₂O ABSORPTION LINES FROM 2725 cm⁻¹ to 2842 cm⁻¹

key:

Band	Isotopomer	Vibrational Transition
A	¹⁴ N ¹⁴ N ¹⁶ O	11 ¹ 0-00 ⁰ 0
B		12 ² 0-01 ^{1e} 0
C		12 ² 0-01 ^{1f} 0
D		11 ¹ 1-00 ⁰ 1
E		13 ³ 0-02 ^{2e} 0
F		13 ³ 0-02 ^{2f} 0
G		13 ¹ 0-02 ⁰ 0
H		12 ⁰ 0-01 ¹ 0
I		13 ¹ 0-02 ^{2e} 0
J		13 ¹ 0-02 ^{2f} 0
P	¹⁴ N ¹⁵ N ¹⁶ O	11 ¹ 0-00 ⁰ 0
R	¹⁵ N ¹⁴ N ¹⁶ O	11 ¹ 0-00 ⁰ 0
T	¹⁴ N ¹⁴ N ¹⁸ O	11 ¹ 0-00 ⁰ 0

If the e or f designation is not specified (for $l \neq 0$), then the transition is to either level, depending on the selection rules and the change in the rotational quantum number, J . Spectra are given for a slitwidth of 0.002 cm⁻¹ and a transition moment of 0.0086 debye at a temperature of 296 K. No Herman-Wallis constants were included in the intensity calculations.

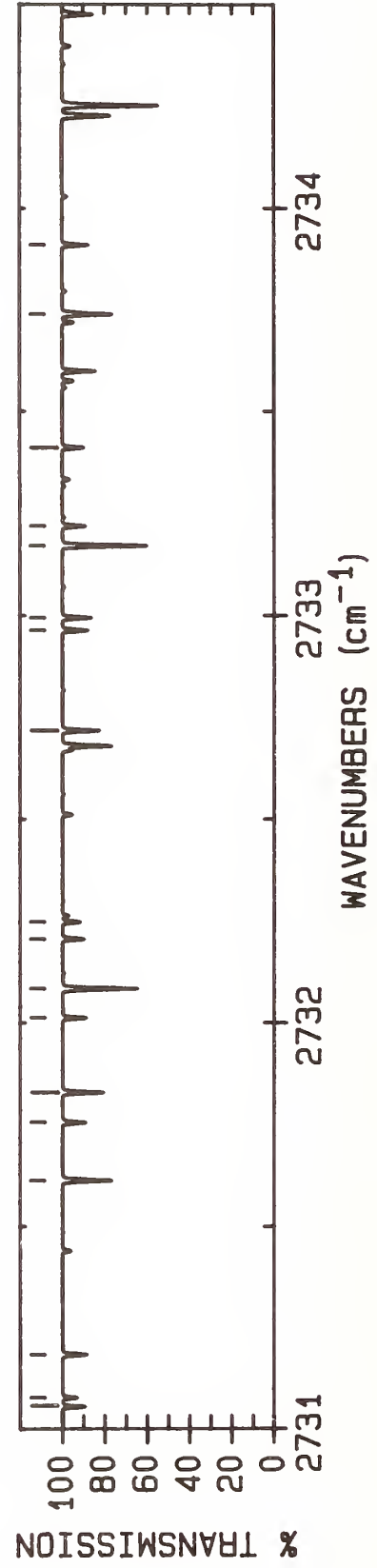
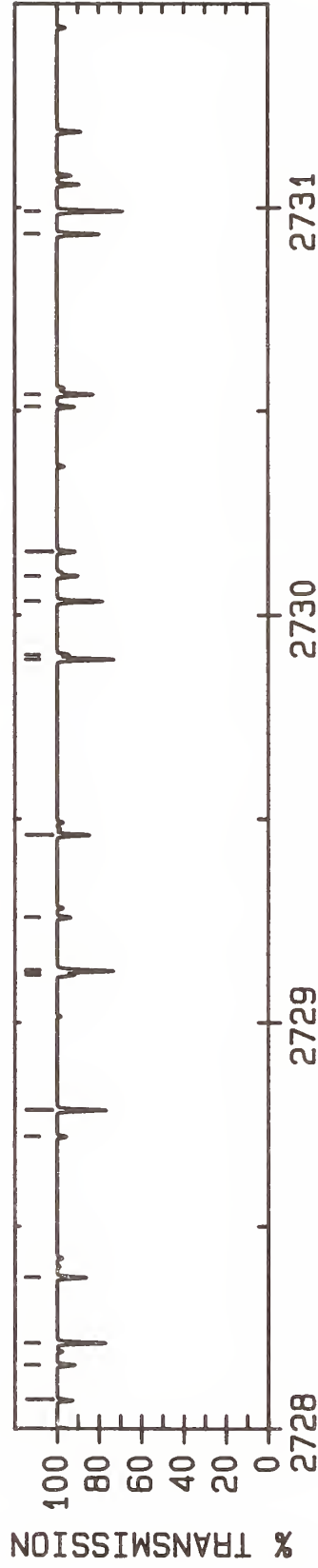
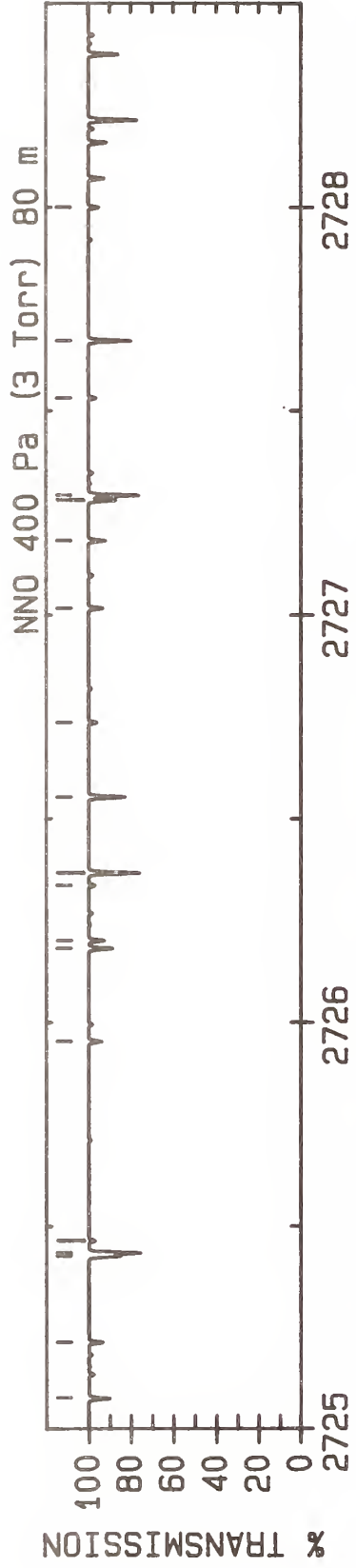

LINE #	WAVENUMBER(cm ⁻¹)	LOWER STATE (cm ⁻¹)	INTENSITY (cm/molecule)	ASSIGNMENT ROTATION BAND	LINE #	WAVENUMBER(unc)(cm ⁻¹)	LOWER STATE (cm ⁻¹)	INTENSITY (cm/molecule)	ASSIGNMENT ROTATION BAND
1	2725.076 61(75)	1822.61	0.908E-24	P(39) G	31	2729.891 75(5)	1533.53	0.272E-23	P(47) H
2	2725.215 89(30)	1594.33	0.612E-24	P(31) J	32	2729.902 81(7)	1834.50	0.515E-24	P(54) C
3	2725.428 30(7)	1699.17	0.136E-23	P(51) H	33	2730.034 1	55.30	0.209E-23	P(11) P
4	2725.435 9	113.95	0.236E-23	P(16) P	34	2730.095 87(26)	1472.58	0.915E-24	P(26) J
5	2725.465 99(18)*	2019.71	0.278E-24	P(69) A	35	2730.155 57(54)	1450.78	0.804E-24	P(25) I
6	2725.954 14(63)	1543.16	0.558E-24	P(29) I	36	2730.510 54(15)*	1794.32	0.784E-24	P(65) A
7	2726.182 62(74)	1789.92	0.103E-23	P(38) G	37	2730.540 82(70)	1667.49	0.164E-23	P(34) G
8	2726.201 94(29)	1568.31	0.669E-24	P(30) J	38	2730.935 0	46.09	0.197E-23	P(10) P
9	2726.337 45(9)	1975.23	0.275E-24	P(57) C	39	2730.991 38(5)	1494.20	0.320E-23	P(46) H
10	2726.368 1	100.55	0.235E-23	P(15) P	40	2731.056 89(25)	1450.75	0.977E-24	P(25) J
11	2726.553 97(6)	1656.51	0.163E-23	P(50) H	41	2731.078 75(6)	1789.25	0.629E-24	P(53) C
12	2726.736 53(17)*	1962.12	0.363E-24	P(68) A	42	2731.185 17(52)	1429.78	0.868E-24	P(24) I
13	2727.017 04(61)	1518.81	0.617E-24	P(28) I	43	2731.613 77(69)	1638.97	0.182E-23	P(33) G
14	2727.182 94(28)	1543.12	0.729E-24	P(29) J	44	2731.756 00(15)*	1740.04	0.100E-23	P(64) A
15	2727.282 07(73)	1758.06	0.117E-23	P(37) G	45	2731.829 6	37.71	0.183E-23	P(9) P
16	2727.294 0	87.98	0.232E-23	P(14) P	46	2732.012 95(24)	1429.76	0.104E-23	P(24) J
17	2727.532 15(8)	1927.48	0.340E-24	P(56) C	47	2732.084 58(5)	1455.70	0.374E-23	P(45) H
18	2727.673 08(6)	1614.68	0.194E-23	P(49) H	48	2732.206 56(50)	1409.62	0.931E-24	P(23) I
19	2728.000 81(16)*	1905.36	0.471E-24	P(67) A	49	2732.248 44(6)	1744.84	0.766E-24	P(52) C
20	2728.071 55(59)	1495.29	0.678E-24	P(27) I	50	2732.717 9	30.17	0.166E-23	P(8) P
21	2728.158 92(27)	1518.77	0.790E-24	P(28) J	51	2732.964 08(24)	1409.60	0.110E-23	P(23) J
22	2728.213 6	76.25	0.227E-23	P(13) P	52	2732.995 19(14)*	1686.59	0.128E-23	P(63) A
23	2728.374 95(72)	1727.03	0.131E-23	P(36) G	53	2733.171 40(5)	1418.04	0.436E-23	P(44) H
24	2728.720 61(7)	1880.57	0.419E-24	P(55) C	54	2733.219 77(47)	1390.30	0.994E-24	P(22) I
25	2728.785 66(6)	1573.69	0.230E-23	P(48) H	55	2733.411 86(5)	1701.27	0.927E-24	P(51) C
26	2729.117 71(57)	1472.61	0.740E-24	P(26) I	56	2733.739 53(66)	1584.45	0.221E-23	P(31) G
27	2729.127 0	65.36	0.219E-23	P(12) P	57	2733.910 30(23)	1390.28	0.115E-23	P(22) J
28	2729.129 89(26)	1495.26	0.852E-24	P(27) J					
29	2729.258 81(16)*	1849.42	0.609E-24	P(66) A					
30	2729.461 21(71)	1696.84	0.147E-23	P(35) G					

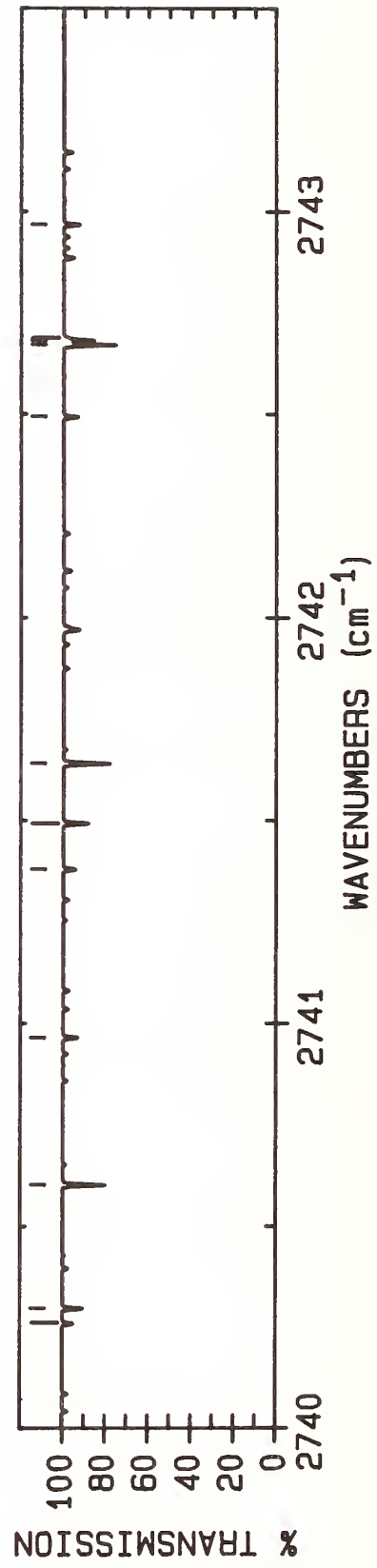
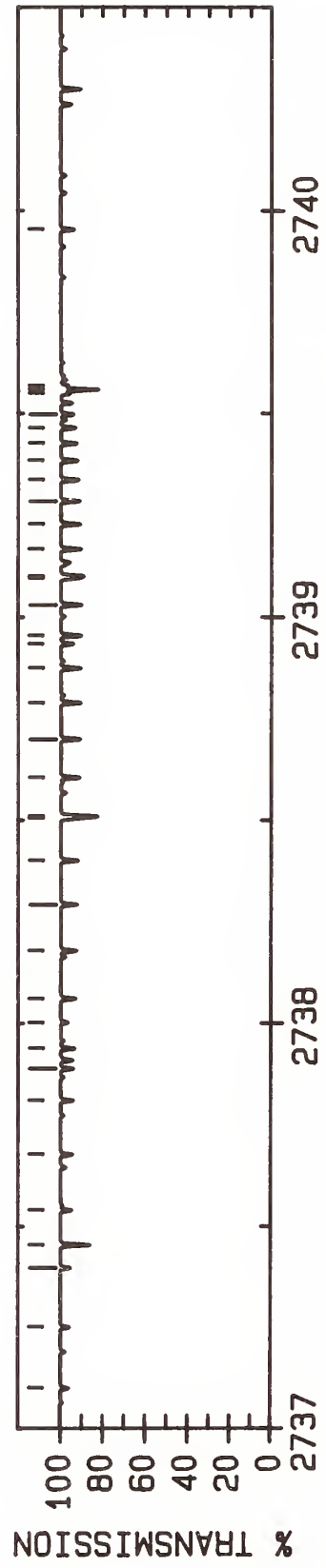
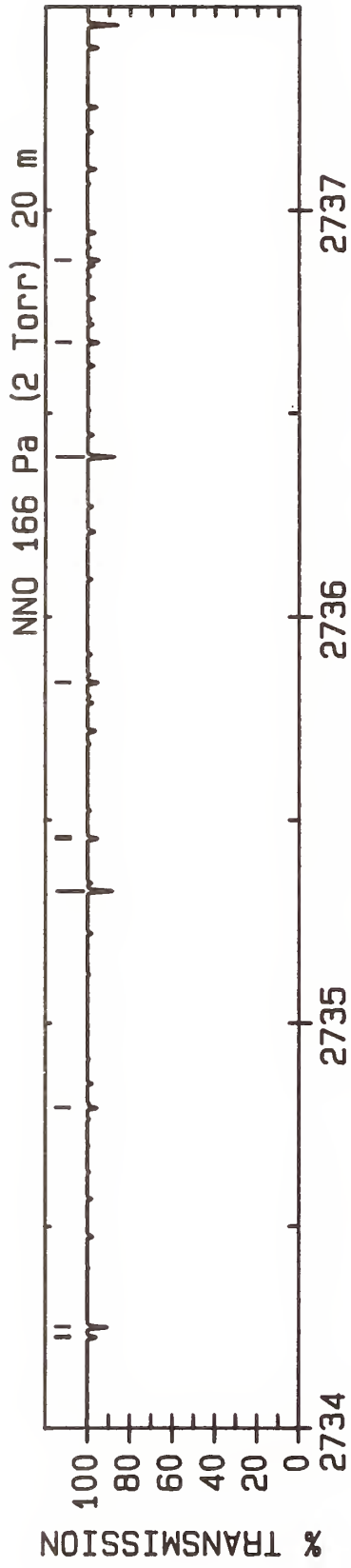

LINE #	WAVENUMBER(unc) (cm ⁻¹)	LOWER STATE (cm ⁻¹)	INTENSITY (cm/molecule)	ASSIGNMENT ROTATION BAND	LINE #	WAVENUMBER(unc) (cm ⁻¹)	LOWER STATE (cm ⁻¹)	INTENSITY (cm/molecule)	ASSIGNMENT ROTATION BAND
1	2734.224 84(45)	1371.82	0.105E-23	P(21) I	36	2739.096 87(12)*	1431.79	0.408E-23	P(58) A
2	2734.228 09(14)*	1633.97	0.163E-23	P(62) A	37	2739.101 9	87.98	0.520E-23	Q(14) P
3	2734.251 87(5)	1381.21	0.506E-23	P(43) H	38	2739.168 0	76.25	0.512E-23	Q(13) P
4	2734.792 30(64)	1558.45	0.241E-23	P(30) G	39	2739.229 5	65.36	0.500E-23	Q(12) P
5	2735.326 03(5)	1345.22	0.584E-23	P(42) H	40	2739.286 2	55.30	0.483E-23	Q(11) P
6	2735.454 71(13)*	1582.18	0.206E-23	P(61) A	41	2739.338 1	46.09	0.461E-23	Q(10) P
7	2735.455 8	663.53	0.414E-24	P(40) R	42	2739.385 4	37.71	0.435E-23	Q(9) P
8	2735.458 6	2073.73	0.132E-24	P(43) D	43	2739.427 9	30.17	0.404E-23	Q(8) P
9	2735.838 28(62)	1533.28	0.262E-23	P(29) G	44	2739.465 7	23.46	0.368E-23	Q(7) P
10	2736.393 92(5)	1310.06	0.671E-23	P(41) H	45	2739.498 7	17.60	0.328E-23	Q(6) P
11	2736.675 05(13)*	1531.22	0.260E-23	P(60) A	46	2739.550 7	8.38	0.238E-23	Q(4) P
12	2736.877 44(60)	1508.94	0.284E-23	P(28) G	47	2739.560 33(5)	1209.60	0.990E-23	P(38) H
13	2737.101 1	442.25	0.208E-23	Q(32) P	48	2739.569 6	5.03	0.188E-23	Q(3) P
14	2737.252 6	415.46	0.230E-23	Q(31) P	49	2739.953 81(53)	1440.98	0.347E-23	P(25) G
15	2737.399 4	389.50	0.252E-23	Q(30) P	50	2740.260 77(5)	1457.34	0.266E-23	P(45) C
16	2737.455 57(5)	1275.74	0.767E-23	P(40) H	51	2740.298 35(12)*	1383.33	0.508E-23	P(57) A
17	2737.541 3	364.38	0.276E-23	Q(29) P	52	2740.603 52(5)	1177.78	0.112E-22	P(37) H
18	2737.678 6	340.10	0.300E-23	Q(28) P	53	2740.965 47(51)	1420.00	0.367E-23	P(24) G
19	2737.811 1	316.65	0.324E-23	Q(27) P	54	2741.380 29(5)	1419.61	0.312E-23	P(44) C
20	2737.889 11(13)*	1481.09	0.327E-23	P(59) A	55	2741.493 53(12)*	1335.69	0.629E-23	P(56) A
21	2737.938 8	294.04	0.349E-23	Q(26) P	56	2741.640 63(5)	1146.80	0.125E-22	P(36) H
22	2738.002 89(5)	1535.31	0.191E-23	P(47) C	57	2742.493 52(5)	1382.71	0.365E-23	P(43) C
23	2738.061 8	272.26	0.373E-23	Q(25) P	58	2742.671 70(5)	1116.65	0.140E-22	P(35) H
24	2738.180 0	251.32	0.397E-23	Q(24) P	59	2742.682 41(11)*	1288.88	0.775E-23	P(55) A
25	2738.293 5	231.22	0.420E-23	Q(23) P	60	2742.689 4	454.04	0.942E-24	P(33) R
26	2738.402 3	211.96	0.441E-23	Q(22) P	61	2742.967 93(46)	1380.55	0.404E-23	P(22) G
27	2738.506 3	193.53	0.461E-23	Q(21) P					
28	2738.511 03(5)	1242.25	0.874E-23	P(39) H					
29	2738.605 6	175.94	0.479E-23	Q(20) P					
30	2738.700 2	159.19	0.494E-23	Q(19) P					
31	2738.790 0	143.27	0.507E-23	Q(18) P					
32	2738.875 1	128.19	0.516E-23	Q(17) P					
33	2738.935 24(55)	1462.80	0.327E-23	P(26) G					
34	2738.955 4	113.95	0.521E-23	Q(16) P					
35	2739.031 0	100.55	0.523E-23	Q(15) P					

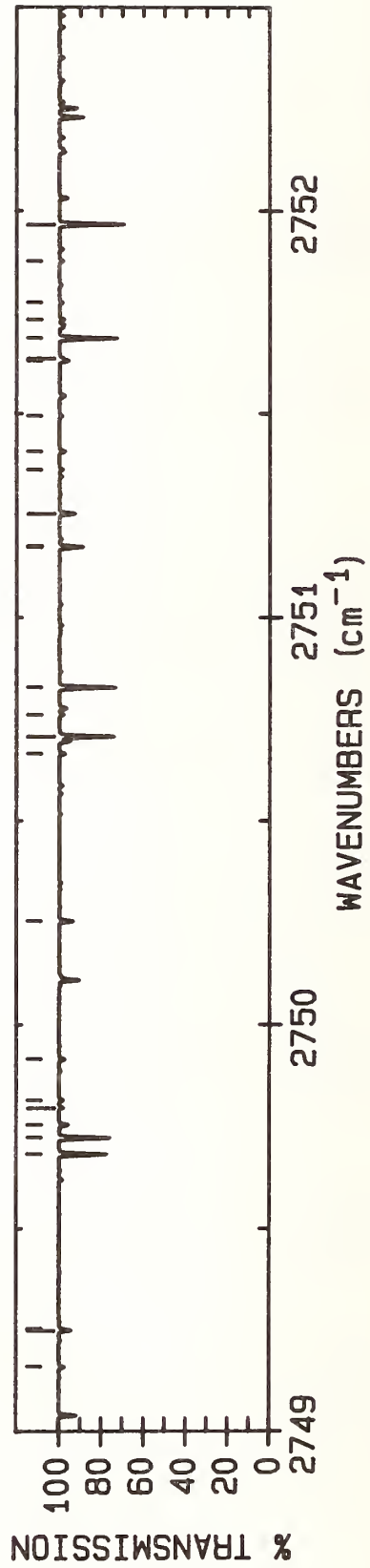
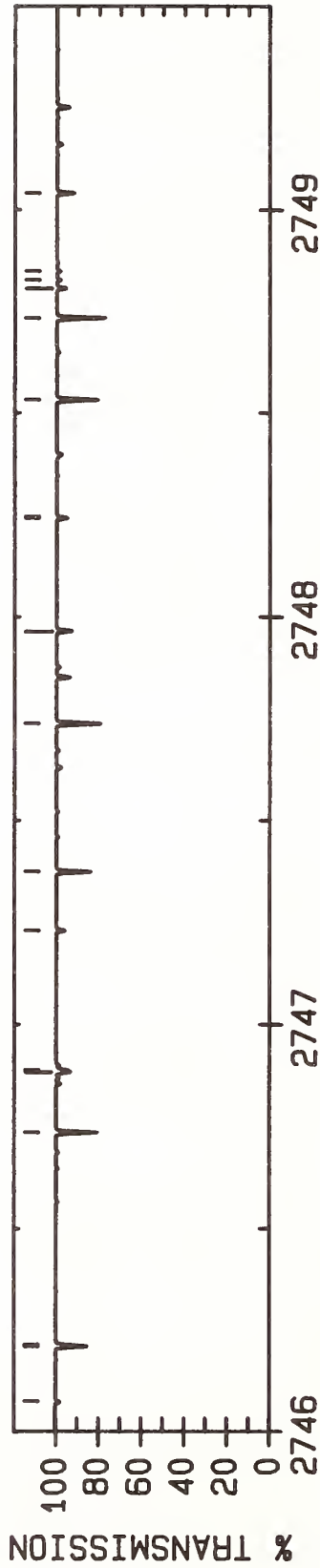
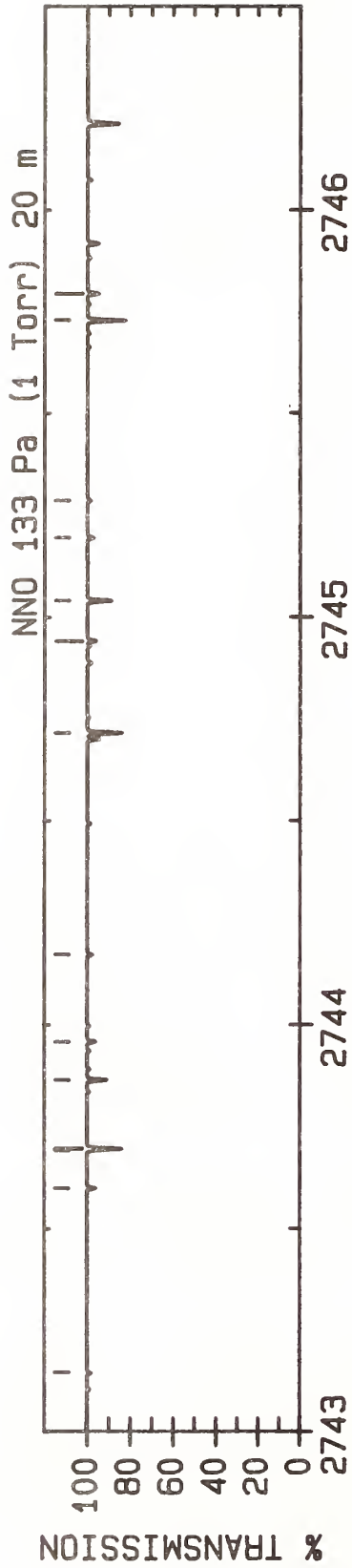

LINE #	WAVENUMBER(cm^{-1})	LOWER STATE (cm^{-1})	INTENSITY (cm^2/mole)	ASSIGNMENT ROTATION BAND	LINE #	WAVENUMBER(cm^{-1})	LOWER STATE (cm^{-1})	INTENSITY (cm^2/mole)	ASSIGNMENT ROTATION BAND
1	2743.145 55(5)	1418.04	0.223E-23	P(44) B	31	2748.826 88(35)	1429.78	0.204E-23	P(24) E
2	2743.600 47(4)	1346.65	0.424E-23	P(42) C	32	2748.848 39(35)	1429.76	0.204E-23	P(24) F
3	2743.693 0	8.38	0.159E-23	R(4) P	33	2749.040 82(4)	1178.89	0.837E-23	P(37) C
4	2743.696 78(5)	1087.34	0.156E-22	P(34) H	34	2749.159 9	55.30	0.274E-23	R(11) P
5	2743.698 1	427.35	0.104E-23	P(32) R	35	2749.250 63(4)	1209.60	0.575E-23	P(38) B
6	2743.865 00(11)*	1242.91	0.952E-23	P(54) A	36	2749.254 65(25)	1190.35	0.979E-24	P(5) J
7	2743.958 69(44)	1362.08	0.419E-23	P(21) G	37	2749.683 38(10)*	1025.52	0.249E-22	P(49) A
8	2744.172 39(5)	1381.21	0.264E-23	P(43) B	38	2749.723 43(4)	929.02	0.267E-22	P(28) H
9	2744.715 89(5)	1058.86	0.173E-22	P(33) H	39	2749.755 21(31)	1268.90	0.455E-23	P(15) G
10	2744.942 43(41)	1344.45	0.433E-23	P(20) G	40	2749.796 75(33)	1409.62	0.214E-23	P(23) E
11	2745.041 29(11)*	1197.77	0.116E-22	P(53) A	41	2749.814 96(33)	1409.60	0.214E-23	P(23) F
12	2745.195 54(5)	1345.22	0.312E-23	P(42) B	42	2749.915 5	65.36	0.281E-23	R(12) P
13	2745.286 7	17.60	0.202E-23	R(6) P	43	2750.254 83(4)	1177.78	0.661E-23	P(37) B
14	2745.729 09(5)	1031.22	0.190E-22	P(32) H	44	2750.664 7	76.25	0.286E-23	R(13) P
15	2745.795 50(4)	1277.04	0.565E-23	P(40) C	45	2750.707 59(4)	905.56	0.287E-22	P(27) H
16	2746.074 0	23.46	0.221E-23	R(7) P	46	2750.760 86(31)	1390.30	0.223E-23	P(22) E
17	2746.211 27(11)*	1153.46	0.142E-22	P(52) A	47	2750.828 13(10)*	984.54	0.297E-22	P(48) A
18	2746.214 98(5)	1310.06	0.366E-23	P(41) B	48	2751.172 86(4)	1117.64	0.106E-22	P(35) C
19	2746.736 40(5)	1004.42	0.209E-22	P(31) H	49	2751.175 36(54)	1429.76	0.165E-23	Q(24) J
20	2746.883 57(4)	1243.48	0.647E-23	P(39) C	50	2751.255 12(4)	1146.80	0.756E-23	P(36) B
21	2746.888 80(37)	1311.72	0.452E-23	P(18) G	51	2751.362 38(52)	1409.60	0.175E-23	Q(23) J
22	2747.230 67(4)	1275.74	0.428E-23	P(40) B	52	2751.407 5	87.98	0.288E-23	R(14) P
23	2747.374 95(10)*	1109.98	0.172E-22	P(51) A	53	2751.494 02(28)	1518.81	0.154E-23	Q(28) I
24	2747.737 88(4)	978.45	0.228E-22	P(30) H	54	2751.630 50(27)	1244.55	0.437E-23	P(13) G
25	2747.965 35(4)	1210.77	0.738E-23	P(38) C	55	2751.636 58(27)	1495.29	0.165E-23	Q(27) I
26	2748.242 56(4)	1242.25	0.497E-23	P(39) B	56	2751.686 04(4)	882.94	0.307E-22	P(26) H
27	2748.246 1	1698.65	0.586E-24	P(31) D	57	2751.732 00(29)	1371.80	0.231E-23	P(21) F
28	2748.532 32(10)*	1067.33	0.207E-22	P(50) A	58	2751.773 50(26)	1472.61	0.176E-23	Q(26) I
29	2748.733 54(4)	953.32	0.247E-22	P(29) H	59	2751.876 03(45)	1354.16	0.203E-23	Q(20) J
30	2748.806 85(32)	1282.33	0.458E-23	P(16) G	60	2751.966 56(10)*	944.39	0.354E-22	P(47) A

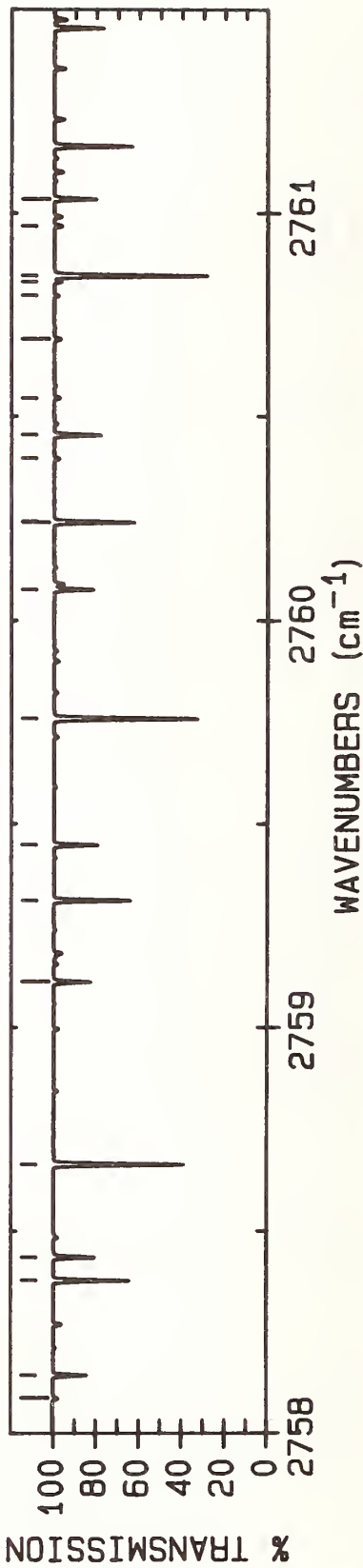
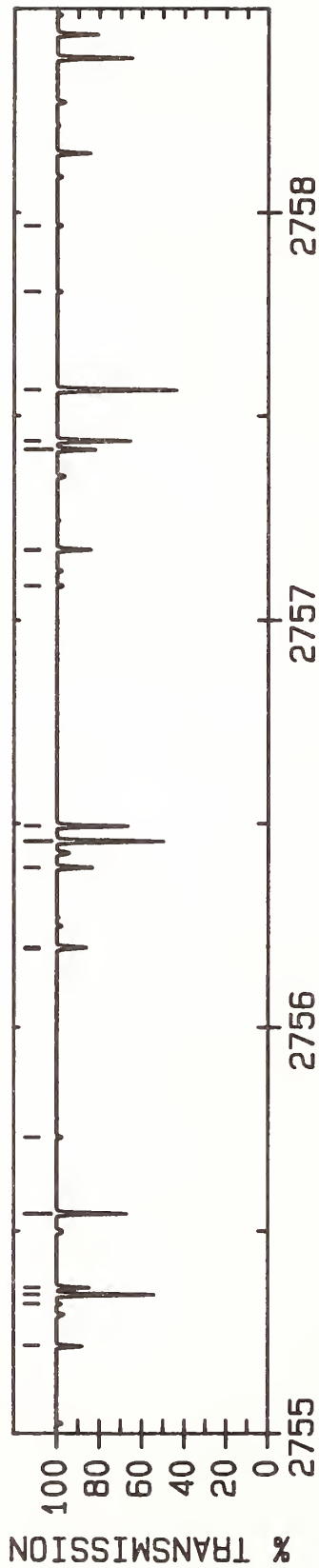
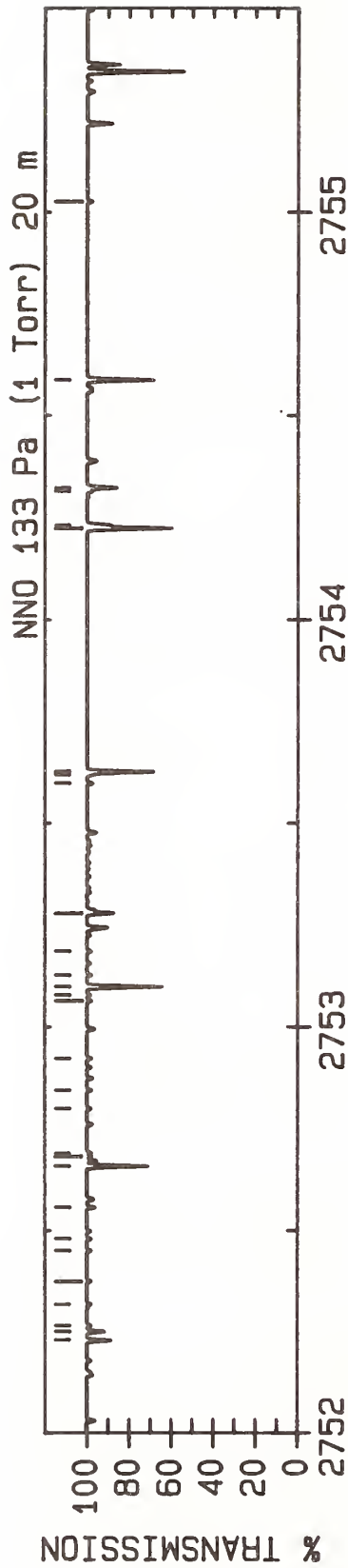

LINE #	WAVENUMBER(unc) (cm ⁻¹)	LOWER STATE (cm ⁻¹)	INTENSITY (cm/molecule)	ASSIGNMENT ROTATION BAND	LINE #	WAVENUMBER(unc) (cm ⁻¹)	LOWER STATE (cm ⁻¹)	INTENSITY (cm/molecule)	ASSIGNMENT ROTATION BAND
1	2752.229 41(4)	1088.28	0.119E-22	P(34) C	36	2755.730 3	175.94	0.259E-23	R(20) P
2	2752.251 48(3)	1116.65	0.860E-23	P(35) B	37	2756.192 98(23)	1198.37	0.317E-23	P(8) G
3	2752.265 94(24)	1390.30	0.216E-23	Q(22) I	38	2756.196 68(3)	1004.42	0.136E-22	P(31) B
4	2752.318 85(38)	1306.29	0.222E-23	Q(17) J	39	2756.392 46(3)	979.18	0.176E-22	P(30) C
5	2752.375 50(23)	1371.82	0.224E-23	Q(21) I	40	2756.457 07(9)*	792.14	0.678E-22	P(43) A
6	2752.450 78(36)	1292.01	0.225E-23	Q(16) J	41	2756.493 97(4)	782.39	0.395E-22	P(21) H
7	2752.479 75(23)	1354.18	0.231E-23	Q(20) I	42	2757.083 81(23)	1191.65	0.280E-23	P(7) G
8	2752.557 40(26)	1233.63	0.422E-23	P(12) G	43	2757.170 9	138.44	0.233E-23	P(18) R
9	2752.658 83(4)	861.16	0.326E-22	P(25) H	44	2757.172 74(3)	978.45	0.151E-22	P(30) B
10	2752.682 45(27)	1354.16	0.237E-23	P(20) F	45	2757.417 42(3)	954.01	0.192E-22	P(29) C
11	2752.691 18(33)	1265.96	0.226E-23	Q(14) J	46	2757.438 89(4)	764.79	0.409E-22	P(20) H
12	2752.799 68(31)	1254.20	0.223E-23	Q(13) J	47	2757.563 88(9)*	756.16	0.788E-22	P(42) A
13	2752.844 43(22)	1292.01	0.245E-23	Q(16) I	48	2757.805 2	231.22	0.225E-23	R(23) P
14	2752.922 74(22)	1278.57	0.244E-23	Q(15) I	49	2757.967 37(22)	1185.77	0.240E-23	P(6) G
15	2753.064 17(22)	1254.20	0.236E-23	Q(13) I	50	2758.086 8	123.87	0.236E-23	P(17) R
16	2753.078 47(28)	1223.96	0.201E-23	Q(10) J	51	2758.144 63(3)	953.32	0.166E-22	P(29) B
17	2753.098 67(10)*	905.08	0.419E-22	P(46) A	52	2758.378 33(4)	748.03	0.420E-22	P(19) H
18	2753.127 36(23)	1243.28	0.229E-23	Q(12) I	53	2758.436 05(3)	929.66	0.208E-22	P(28) C
19	2753.185 58(23)	1233.20	0.220E-23	Q(11) I	54	2758.664 35(9)*	721.01	0.913E-22	P(41) A
20	2753.279 65(4)	1059.75	0.132E-22	P(33) C	55	2759.112 31(3)	929.02	0.182E-22	P(28) B
21	2753.597 6	128.19	0.281E-23	R(17) P	56	2759.312 31(4)	732.11	0.430E-22	P(18) H
22	2753.618 87(26)	1337.38	0.241E-23	P(19) E	57	2759.448 34(3)	906.16	0.224E-22	P(27) C
23	2753.625 99(4)	840.21	0.345E-22	P(24) H	58	2759.758 49(9)*	686.70	0.105E-21	P(40) A
24	2753.627 50(26)	1337.37	0.241E-23	P(19) F	59	2760.075 74(3)	905.56	0.198E-22	P(27) B
25	2754.224 46(9)*	866.60	0.494E-22	P(45) A	60	2760.240 85(4)	717.02	0.436E-22	P(17) H
26	2754.232 20(3)	1058.86	0.110E-22	P(33) B	61	2760.243 30(37)	1727.03	0.226E-23	Q(36) G
27	2754.314 9	143.27	0.276E-23	R(18) P	62	2760.396 47(35)	1696.84	0.256E-23	Q(35) G
28	2754.323 58(4)	1032.06	0.146E-22	P(32) C	63	2760.454 30(3)	883.50	0.239E-22	P(26) C
29	2754.587 54(4)	820.10	0.363E-22	P(23) H	64	2760.545 59(33)	1667.49	0.289E-23	Q(34) G
30	2755.025 8	159.19	0.268E-23	R(19) P	65	2760.690 64(32)	1638.97	0.324E-23	Q(33) G
31	2755.216 49(3)	1031.22	0.123E-22	P(32) B	66	2760.797 0	85.01	0.231E-23	P(14) R
32	2755.320 6	170.01	0.223E-23	P(20) R	67	2760.831 60(30)	1611.29	0.361E-23	Q(32) G
33	2755.343 93(9)*	828.95	0.580E-22	P(44) A	68	2760.846 30(9)*	653.23	0.121E-21	P(39) A
34	2755.361 18(3)	1005.20	0.161E-22	P(31) C	69	2760.968 48(29)	1584.45	0.401E-23	Q(31) G
35	2755.543 53(4)	800.83	0.380E-22	P(22) H	70	2761.034 89(3)	882.94	0.213E-22	P(26) B

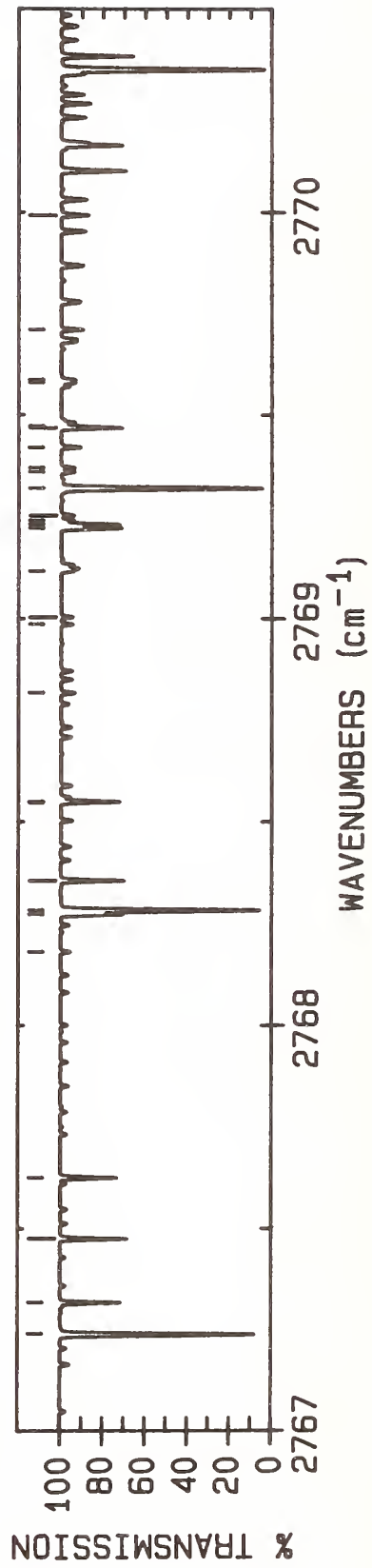
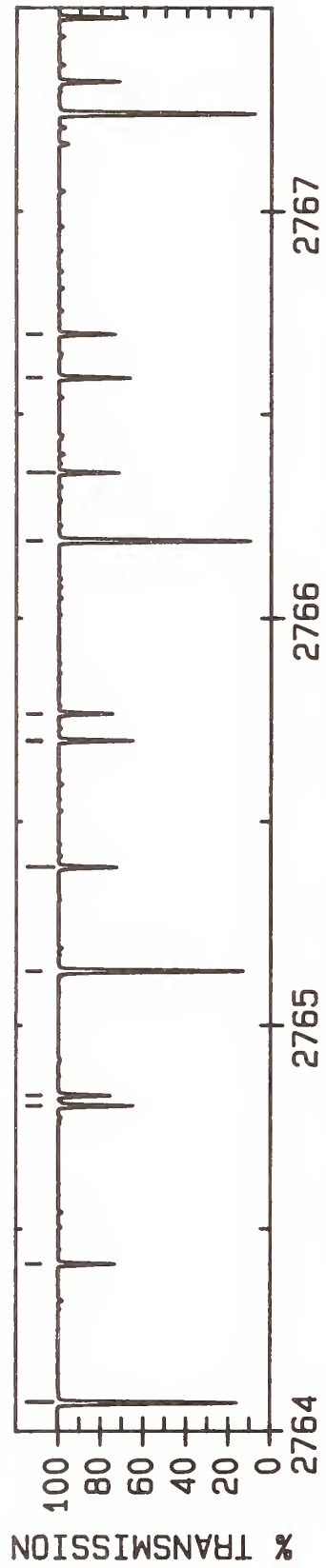
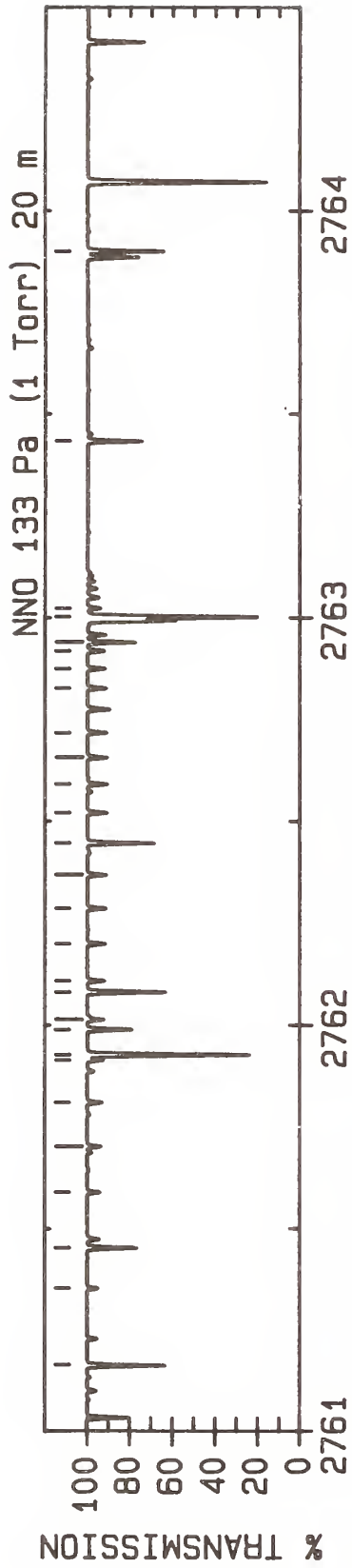

LINE #	WAVENUMBER(unc) (cm ⁻¹)	LOWER STATE (cm ⁻¹)	INTENSITY (cm/molecule)	ASSIGNMENT ROTATION BAND	LINE #	WAVENUMBER(unc) (cm ⁻¹)	LOWER STATE (cm ⁻¹)	INTENSITY (cm/molecule)	ASSIGNMENT ROTATION BAND
1	2761.163 98(4)	702.77	0.439E-22	P(16) H	36	2765.696 88(7)	1701.27	0.126E-23	Q(51) H
2	2761.354 42(25)	1508.94	0.531E-23	Q(28) G	37	2765.699 09(5)	644.10	0.405E-22	P(11) H
3	2761.453 92(3)	861.67	0.255E-22	P(25) C	38	2765.765 19(3)	782.39	0.285E-22	P(21) B
4	2761.591 03(23)	1462.80	0.624E-23	Q(26) G	39	2766.190 13(9)*	498.37	0.223E-21	P(34) A
5	2761.703 08(22)	1440.98	0.670E-23	Q(25) G	40	2766.356 82(3)	765.12	0.316E-22	P(20) C
6	2761.810 96(21)	1420.00	0.716E-23	Q(24) G	41	2766.590 13(5)	634.88	0.388E-22	P(10) H
7	2761.914 63(20)	1399.85	0.760E-23	Q(23) G	42	2766.697 93(3)	764.79	0.295E-22	P(20) B
8	2761.927 76(9)*	620.59	0.138E-21	P(38) A	43	2767.239 84(9)*	469.91	0.248E-21	P(33) A
9	2761.989 72(3)	861.16	0.229E-22	P(25) B	44	2767.318 33(3)	748.33	0.323E-22	P(19) C
10	2762.014 10(20)	1380.55	0.802E-23	Q(22) G	45	2767.475 87(5)	626.49	0.366E-22	P(9) H
11	2762.081 71(4)	689.36	0.440E-22	P(15) H	46	2767.626 15(3)	748.03	0.304E-22	P(19) B
12	2762.109 35(19)	1362.08	0.842E-23	Q(21) G	47	2768.181 34(5)	1419.61	0.484E-23	Q(44) H
13	2762.200 37(18)	1344.45	0.877E-23	Q(20) G	48	2768.273 48(3)	732.38	0.328E-22	P(18) C
14	2762.287 13(18)	1327.67	0.909E-23	Q(19) G	49	2768.283 19(9)*	442.28	0.275E-21	P(32) A
15	2762.369 64(17)	1311.72	0.934E-23	Q(18) G	50	2768.356 33(5)	618.95	0.341E-22	P(8) H
16	2762.447 20(3)	840.68	0.270E-22	P(24) C	51	2768.547 08(22)	1321.41	0.106E-23	R(18) J
17	2762.447 88(17)	1296.61	0.954E-23	Q(17) G	52	2768.549 84(3)	732.11	0.310E-22	P(18) B
18	2762.521 84(17)	1282.33	0.967E-23	Q(16) G	53	2768.817 36(5)	1346.65	0.680E-23	Q(42) H
19	2762.591 51(17)	1268.90	0.972E-23	Q(15) G	54	2768.986 45(35)	1409.62	0.577E-23	Q(23) E
20	2762.656 88(17)	1256.31	0.969E-23	Q(14) G	55	2769.004 08(35)	1409.60	0.576E-23	Q(23) F
21	2762.717 93(18)	1244.55	0.957E-23	Q(13) G	56	2769.116 82(33)	1390.30	0.605E-23	Q(22) E
22	2762.827 07(18)	1223.56	0.907E-23	Q(11) G	57	2769.222 26(3)	717.26	0.330E-22	P(17) C
23	2762.875 13(19)	1214.32	0.868E-23	Q(10) G	58	2769.231 51(5)	612.24	0.313E-22	P(7) H
24	2762.918 85(20)	1205.92	0.819E-23	Q(9) G	59	2769.241 37(31)	1371.82	0.631E-23	Q(21) E
25	2762.940 20(3)	840.21	0.244E-22	P(24) B	60	2769.253 79(31)	1371.80	0.630E-23	Q(21) F
26	2763.002 87(9)*	588.78	0.157E-21	P(37) A	61	2769.320 18(9)*	415.49	0.303E-21	P(31) A
27	2763.023 87(21)	1185.77	0.620E-23	Q(6) G	62	2769.360 14(29)	1354.18	0.653E-23	Q(20) E
28	2763.434 13(3)	820.54	0.283E-22	P(23) C	63	2769.370 43(29)	1354.16	0.653E-23	Q(20) F
29	2763.901 08(5)	665.05	0.430E-22	P(13) H	64	2769.421 15(5)	1277.04	0.937E-23	Q(40) H
30	2764.071 65(9)*	557.81	0.177E-21	P(36) A	65	2769.468 96(3)	717.02	0.314E-22	P(17) B
31	2764.414 72(3)	801.23	0.296E-22	P(22) C	66	2769.473 14(27)	1337.38	0.672E-23	Q(19) E
32	2764.802 75(5)	654.15	0.419E-22	P(12) H	67	2769.580 38(26)	1321.41	0.687E-23	Q(18) E
33	2764.827 97(3)	800.83	0.273E-22	P(22) B	68	2769.587 23(26)	1321.41	0.686E-23	Q(18) F
34	2765.134 07(9)*	527.67	0.199E-21	P(35) A	69	2769.711 06(5)	1243.48	0.109E-22	Q(39) H
35	2765.388 94(3)	782.76	0.307E-22	P(21) C	70	2769.993 04(5)	1210.77	0.126E-22	Q(38) H

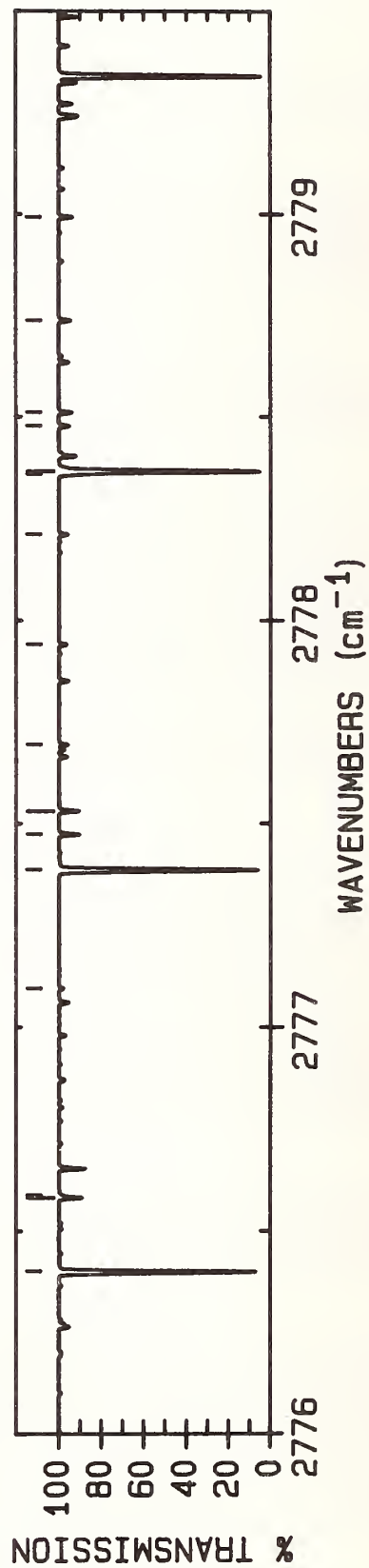
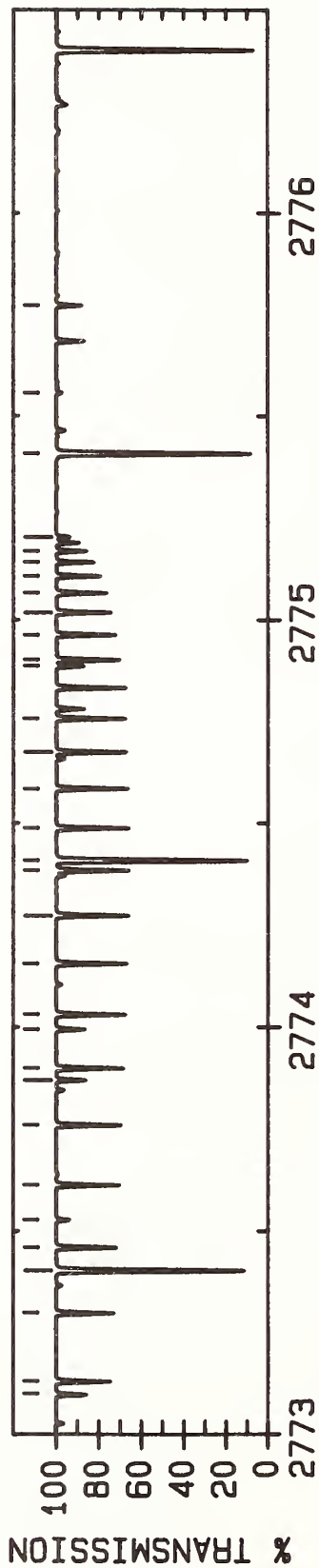
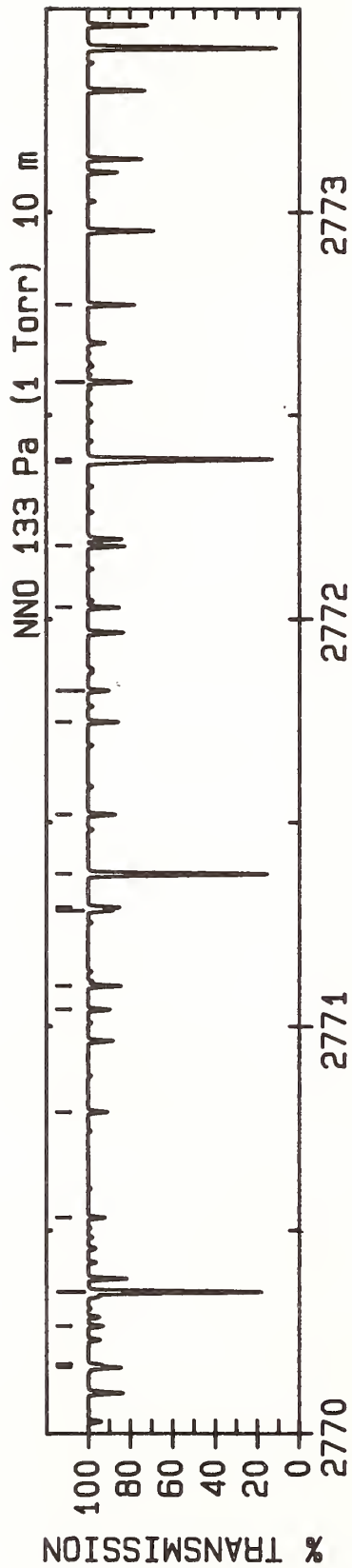

LINE #	WAVENUMBER(linc) (cm ⁻¹)	LOWER STATE (cm ⁻¹)	INTENSITY (cm/molecule)	ASSIGNMENT ROTATION BAND	LINE #	WAVENUMBER(unc) (cm ⁻¹)	LOWER STATE (cm ⁻¹)	INTENSITY (cm/molecule)	ASSIGNMENT ROTATION BAND
1	2770.164 67(4)	702.99	0.329E-22	P(16) C	36	2774.384 73(4)	689.55	0.798E-22	Q(15) H
2	2770.171 13(20)	1233.20	0.631E-23	Q(11) E	37	2774.409 58(9)*	294.06	0.457E-21	P(26) A
3	2770.172 15(20)	1233.20	0.631E-23	Q(11) F	38	2774.488 36(4)	676.95	0.798E-22	Q(14) H
4	2770.267 13(5)	1178.89	0.146E-22	Q(37) H	39	2774.584 98(5)	665.20	0.790E-22	Q(13) H
5	2770.350 81(9)*	389.53	0.333E-21	P(30) A	40	2774.674 61(5)	654.28	0.775E-22	Q(12) H
6	2770.533 38(5)	1147.85	0.167E-22	Q(36) H	41	2774.757 26(5)	644.20	0.752E-22	Q(11) H
7	2770.791 82(5)	1117.64	0.191E-22	Q(35) H	42	2774.886 27(4)	644.10	0.268E-22	P(11) B
8	2771.042 50(5)	1088.28	0.217E-22	Q(34) H	43	2774.901 70(5)	626.56	0.681E-22	Q(9) H
9	2771.100 70(4)	689.55	0.325E-22	P(15) C	44	2774.963 54(5)	619.00	0.634E-22	Q(8) H
10	2771.285 47(5)	1059.75	0.245E-22	Q(33) H	45	2775.018 46(5)	612.29	0.580E-22	Q(7) H
11	2771.293 37(4)	689.36	0.312E-22	P(15) B	46	2775.066 49(5)	606.41	0.518E-22	Q(6) H
12	2771.375 06(9)*	364.41	0.363E-21	P(29) A	47	2775.107 64(5)	601.37	0.450E-22	Q(5) H
13	2771.520 76(5)	1032.06	0.275E-22	Q(32) H	48	2775.141 91(6)	597.17	0.377E-22	Q(4) H
14	2771.748 42(5)	1005.20	0.307E-22	Q(31) H	49	2775.169 32(6)	593.81	0.298E-22	Q(3) H
15	2771.825 45(6)	597.15	0.210E-22	P(4) H	50	2775.203 57(6)	589.61	0.131E-22	Q(1) H
16	2772.030 36(4)	676.95	0.317E-22	P(14) C	51	2775.408 33(9)*	272.28	0.488E-21	P(25) A
17	2772.181 00(4)	954.01	0.377E-22	Q(29) H	52	2775.557 20(34)	1268.90	0.555E-23	R(15) G
18	2772.386 01(4)	929.66	0.414E-22	Q(28) H	53	2775.772 71(4)	634.88	0.247E-22	P(10) B
19	2772.392 94(9)*	340.12	0.394E-21	P(28) A	54	2776.400 69(9)*	251.34	0.518E-21	P(24) A
20	2772.583 55(4)	906.16	0.452E-22	Q(27) H	55	2776.582 83(4)	626.56	0.226E-22	P(9) C
21	2772.773 66(4)	883.50	0.491E-22	Q(26) H	56	2776.589 2	1372.52	0.279E-23	Q(14) D
22	2773.099 20(4)	665.05	0.297E-22	P(13) B	57	2777.095 57(6)	1575.55	0.469E-23	Q(48) C
23	2773.131 74(4)	840.68	0.569E-22	Q(24) H	58	2777.386 66(9)*	231.24	0.546E-21	P(23) A
24	2773.299 79(4)	820.54	0.607E-22	Q(23) H	59	2777.474 13(4)	619.00	0.198E-22	P(8) C
25	2773.404 45(9)*	316.67	0.426E-21	P(27) A	60	2777.531 33(4)	618.95	0.196E-22	P(8) B
26	2773.460 55(4)	801.23	0.643E-22	Q(22) H	61	2777.693 88(6)	591.28	0.867E-23	R(2) H
27	2773.528 45(6)	591.28	0.129E-22	P(2) H	62	2777.940 73(5)	1457.34	0.761E-23	Q(45) C
28	2773.614 07(4)	782.76	0.678E-22	Q(21) H	63	2778.211 82(5)	1419.61	0.887E-23	Q(44) C
29	2773.760 37(4)	765.12	0.709E-22	Q(20) H	64	2778.359 03(4)	612.29	0.167E-22	P(7) C
30	2773.870 52(4)	654.28	0.291E-22	P(12) C	65	2778.366 24(9)*	211.97	0.573E-21	P(22) A
31	2773.899 49(4)	748.33	0.737E-22	Q(19) H	66	2778.477 55(5)	1382.71	0.103E-22	Q(43) C
32	2773.995 09(4)	654.15	0.284E-22	P(12) B	67	2778.511 13(6)	593.80	0.129E-22	R(3) H
33	2774.031 45(4)	732.38	0.760E-22	Q(18) H	68	2778.737 87(5)	1346.65	0.119E-22	Q(42) C
34	2774.156 29(4)	717.26	0.779E-22	Q(17) H	69	2778.992 77(5)	1311.42	0.136E-22	Q(41) C
35	2774.274 04(4)	702.99	0.792E-22	Q(16) H					

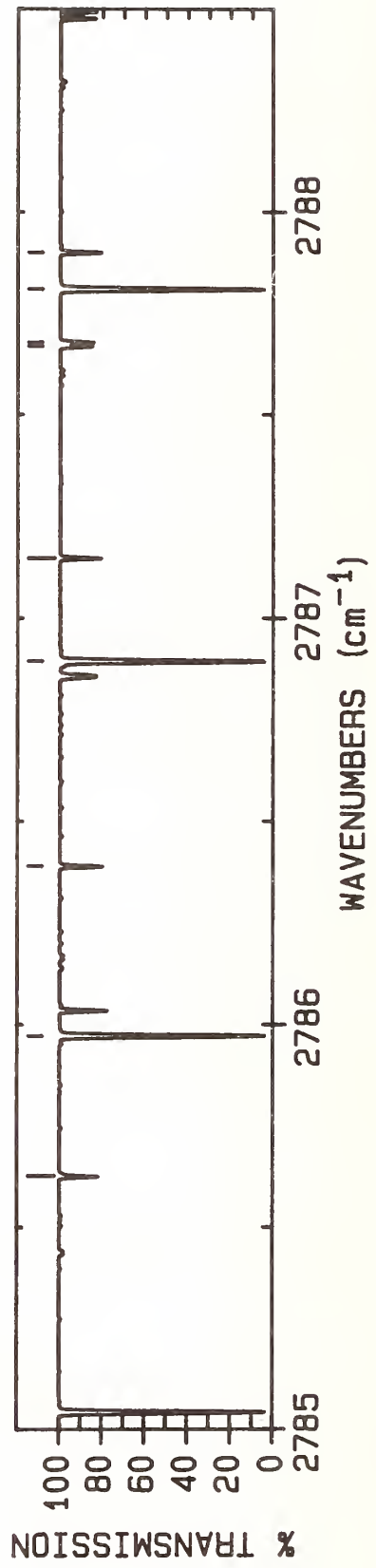
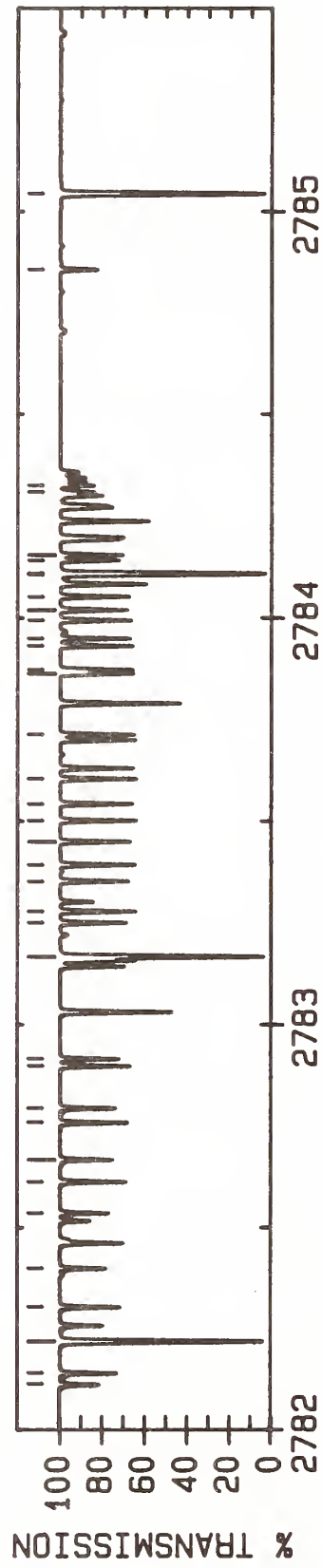
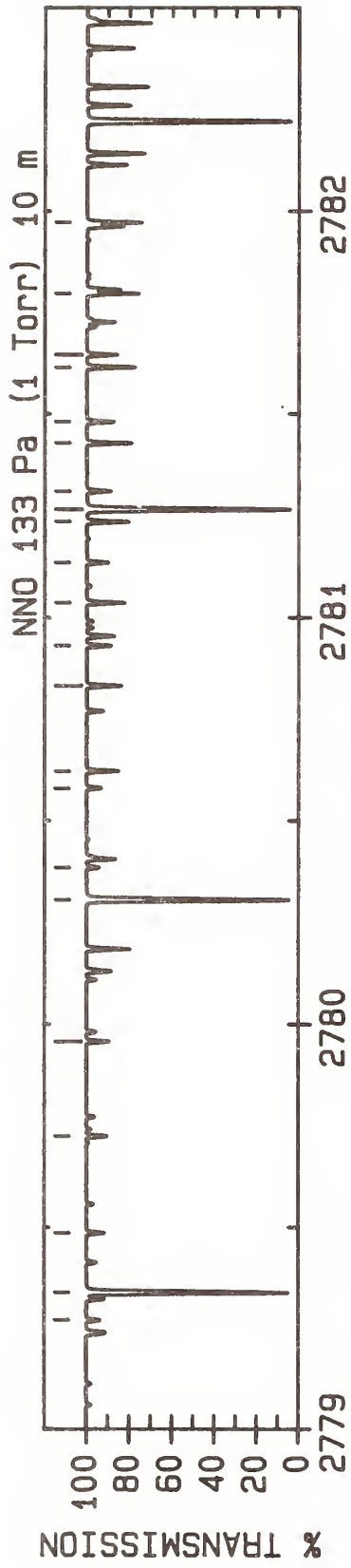

LINE #	WAVENUMBER(unc) (cm ⁻¹)	LOWER STATE (cm ⁻¹)	INTENSITY (cm/molecule)	ASSIGNMENT ROTATION BAND	LINE #	WAVENUMBER(unc) (cm ⁻¹)	LOWER STATE (cm ⁻¹)	INTENSITY (cm/molecule)	ASSIGNMENT ROTATION BAND
1	2779.270 83(5)	606.37	0.133E-22	P(6) B	36	2783.251 45(3)	782.39	0.732E-22	Q(21) B
2	2779.339 43(9)*	193.54	0.597E-21	P(21) A	37	2783.279 27(3)	732.38	0.847E-22	Q(18) C
3	2779.486 16(4)	1243.48	0.177E-22	Q(39) C	38	2783.353 50(3)	764.79	0.760E-22	Q(20) B
4	2779.724 57(4)	1210.77	0.201E-22	Q(38) C	39	2783.393 83(3)	717.26	0.857E-22	Q(17) C
5	2779.957 43(4)	1178.89	0.226E-22	Q(37) C	40	2783.450 69(3)	748.03	0.784E-22	Q(19) B
6	2780.306 21(9)*	175.95	0.618E-21	P(20) A	41	2783.502 15(3)	702.99	0.861E-22	Q(16) C
7	2780.385 40(4)	1275.74	0.126E-22	Q(40) B	42	2783.543 01(3)	732.11	0.804E-22	Q(18) B
8	2780.580 25(4)	1242.25	0.144E-22	Q(39) B	43	2783.604 22(4)	689.55	0.858E-22	Q(15) C
9	2780.622 28(3)	1088.28	0.315E-22	Q(34) C	44	2783.713 06(3)	702.77	0.825E-22	Q(16) B
10	2780.832 54(3)	1059.75	0.349E-22	Q(33) C	45	2783.863 66(4)	676.79	0.821E-22	Q(14) B
11	2780.931 06(5)	606.37	0.244E-22	R(6) H	46	2783.872 73(4)	654.28	0.807E-22	Q(12) C
12	2781.037 06(3)	1032.06	0.384E-22	Q(32) C	47	2783.931 66(4)	665.05	0.808E-22	Q(13) B
13	2781.135 42(4)	1146.80	0.212E-22	Q(36) B	48	2783.949 60(4)	644.20	0.775E-22	Q(11) C
14	2781.235 82(3)	1005.20	0.420E-22	Q(31) C	49	2783.994 80(4)	654.15	0.788E-22	Q(12) B
15	2781.266 60(9)*	159.20	0.635E-21	P(19) A	50	2784.020 12(4)	634.96	0.735E-22	Q(10) C
16	2781.310 68(4)	1116.65	0.239E-22	Q(35) B	51	2784.053 09(4)	644.10	0.759E-22	Q(11) B
17	2781.428 76(3)	979.18	0.458E-22	Q(30) C	52	2784.106 51(4)	634.88	0.723E-22	Q(10) B
18	2781.481 05(4)	1087.34	0.268E-22	Q(34) B	53	2784.109 30(9)*	113.96	0.660E-21	P(16) A
19	2781.615 87(3)	954.01	0.497E-22	Q(29) C	54	2784.142 07(4)	619.00	0.633E-22	Q(8) C
20	2781.646 53(4)	1058.86	0.298E-22	Q(33) B	55	2784.155 07(4)	626.49	0.678E-22	Q(9) B
21	2781.797 10(3)	929.66	0.536E-22	Q(28) C	56	2784.309 22(5)	597.17	0.342E-22	Q(4) C
22	2781.972 43(3)	906.16	0.576E-22	Q(27) C	57	2784.325 03(5)	597.15	0.341E-22	Q(4) B
23	2782.113 64(3)	978.45	0.401E-22	Q(30) B	58	2784.857 17(5)	644.10	0.380E-22	R(11) H
24	2782.141 81(3)	883.50	0.615E-22	Q(26) C	59	2785.044 04(9)*	100.55	0.658E-21	P(15) A
25	2782.220 58(9)*	143.28	0.649E-21	P(18) A	60	2785.626 15(5)	654.15	0.396E-22	R(12) H
26	2782.305 22(3)	861.67	0.653E-22	Q(25) C	61	2785.972 36(9)*	87.98	0.650E-21	P(14) A
27	2782.400 62(3)	929.02	0.477E-22	Q(28) B	62	2786.389 67(4)	665.05	0.409E-22	R(13) H
28	2782.536 80(3)	905.56	0.516E-22	Q(27) B	63	2786.390 0	107.58	0.284E-23	Q(16) T
29	2782.614 00(3)	820.54	0.724E-22	Q(23) C	64	2786.894 25(9)*	76.25	0.635E-21	P(13) A
30	2782.668 09(3)	882.94	0.554E-22	Q(26) B	65	2787.147 68(4)	676.79	0.418E-22	R(14) H
31	2782.759 30(3)	801.23	0.756E-22	Q(22) C	66	2787.668 91(5)	593.81	0.321E-22	R(3) C
32	2782.794 51(3)	861.16	0.593E-22	Q(25) B	67	2787.678 43(5)	593.80	0.321E-22	R(3) B
33	2782.898 51(3)	782.76	0.785E-22	Q(21) C	68	2787.809 71(9)*	65.36	0.614E-21	P(12) A
34	2782.916 05(3)	840.21	0.631E-22	Q(24) B	69	2787.900 17(4)	689.36	0.424E-22	R(15) H
35	2783.168 14(9)*	128.20	0.657E-21	P(17) A					

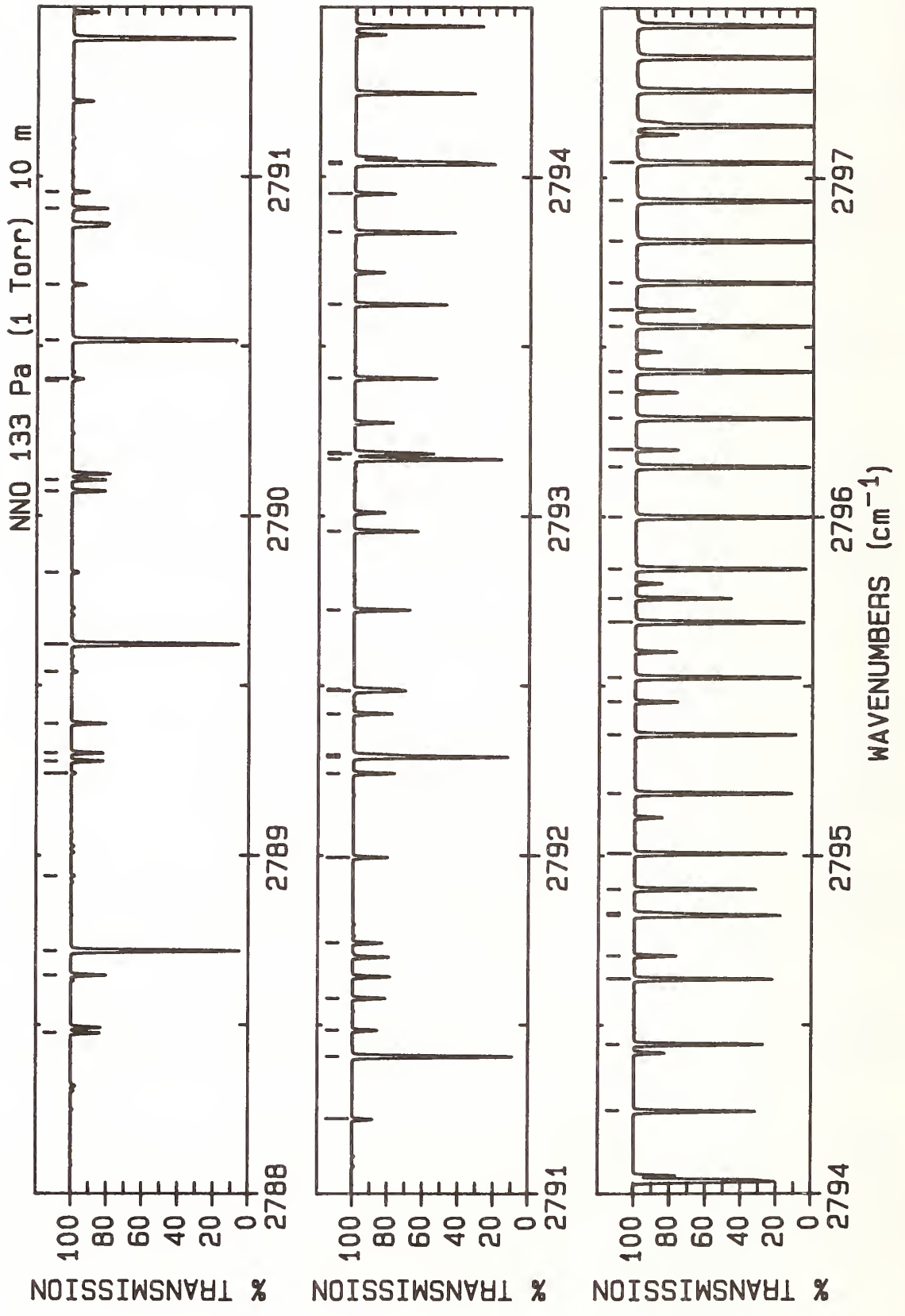

LINE #	WAVENUMBER(unc) (cm ⁻¹)	LOWER STATE (cm ⁻¹)	INTENSITY (cm/molecule)	ASSIGNMENT ROTATION BAND	LINE #	WAVENUMBER(unc) (cm ⁻¹)	LOWER STATE (cm ⁻¹)	INTENSITY (cm/molecule)	ASSIGNMENT ROTATION BAND
1	2788.476 61(5)	597.17	0.354E-22	R(4) C	36	2793.186 94(4)	634.96	0.498E-22	R(10) C
2	2788.647 10(4)	702.77	0.426E-22	R(16) H	37	2793.405 32(9)*	828.95	0.122E-21	Q(44) A
3	2788.718 75(9)*	55.31	0.587E-21	P(11) A	38	2793.622 97(9)*	792.14	0.142E-21	Q(43) A
4	2788.939 53(13)*	1582.18	0.432E-23	Q(61) A	39	2793.835 63(9)*	756.16	0.166E-21	Q(42) A
5	2789.242 41(13)*	1531.22	0.544E-23	Q(60) A	40	2793.949 31(4)	644.20	0.510E-22	R(11) C
6	2789.277 84(4)	601.37	0.386E-22	R(5) C	41	2794.037 66(9)*	12.57	0.289E-21	P(5) A
7	2789.301 70(4)	601.34	0.384E-22	R(5) B	42	2794.043 31(9)*	721.01	0.192E-21	Q(41) A
8	2789.388 44(4)	717.02	0.425E-22	R(17) H	43	2794.246 01(9)*	686.70	0.221E-21	Q(40) A
9	2789.540 25(13)*	1481.09	0.683E-23	Q(59) A	44	2794.443 73(9)*	653.23	0.254E-21	Q(39) A
10	2789.621 34(9)*	46.09	0.552E-21	P(10) A	45	2794.636 48(9)*	620.59	0.290E-21	Q(38) A
11	2789.833 05(12)*	1431.79	0.853E-23	Q(58) A	46	2794.705 19(4)	654.28	0.517E-22	R(12) C
12	2790.072 61(4)	606.41	0.415E-22	R(6) C	47	2794.824 25(9)*	588.78	0.330E-21	Q(37) A
13	2790.106 06(4)	606.37	0.412E-22	R(6) B	48	2794.830 71(4)	654.15	0.504E-22	R(12) B
14	2790.397 55(40)	1450.78	0.305E-23	R(25) E	49	2794.901 56(9)*	8.38	0.222E-21	P(4) A
15	2790.403 56(12)*	1335.69	0.132E-22	Q(56) A	50	2795.007 05(9)*	557.81	0.373E-21	Q(36) A
16	2790.517 50(9)*	37.71	0.512E-21	P(9) A	51	2795.184 89(9)*	527.67	0.420E-21	Q(35) A
17	2790.681 27(11)*	1288.88	0.162E-22	Q(55) A	52	2795.357 75(9)*	498.37	0.471E-21	Q(34) A
18	2790.905 57(4)	612.24	0.437E-22	R(7) B	53	2795.454 57(4)	665.20	0.521E-22	R(13) C
19	2790.953 96(11)*	1242.91	0.199E-22	Q(54) A	54	2795.525 66(9)*	469.91	0.525E-21	Q(33) A
20	2791.221 63(11)*	1197.77	0.243E-22	Q(53) A	55	2795.688 60(9)*	442.28	0.583E-21	Q(32) A
21	2791.407 22(9)*	30.17	0.464E-21	P(8) A	56	2795.759 00(9)*	5.03	0.150E-21	P(3) A
22	2791.484 28(11)*	1153.46	0.296E-22	Q(52) A	57	2795.846 58(9)*	415.49	0.643E-21	Q(31) A
23	2791.578 62(4)	764.79	0.404E-22	R(20) H	58	2795.999 60(9)*	389.53	0.707E-21	Q(30) A
24	2791.741 92(10)*	1109.98	0.359E-22	Q(51) A	59	2796.147 67(9)*	364.41	0.772E-21	Q(29) A
25	2791.994 56(10)*	1067.33	0.433E-22	Q(50) A	60	2796.197 44(4)	676.95	0.520E-22	R(14) C
26	2792.242 18(10)*	1025.52	0.521E-22	Q(49) A	61	2796.290 78(9)*	340.12	0.840E-21	Q(28) A
27	2792.290 48(9)*	23.46	0.411E-21	P(7) A	62	2796.367 18(4)	676.79	0.503E-22	R(14) B
28	2792.297 28(4)	782.39	0.392E-22	R(21) H	63	2796.428 95(9)*	316.67	0.908E-21	Q(27) A
29	2792.418 08(4)	626.56	0.483E-22	R(9) C	64	2796.562 16(9)*	294.06	0.977E-21	Q(26) A
30	2792.484 80(10)*	984.54	0.622E-22	Q(48) A	65	2796.609 96(9)*	2.51	0.760E-22	P(2) A
31	2792.490 08(4)	626.49	0.476E-22	R(9) B	66	2796.690 42(9)*	272.28	0.104E-20	Q(25) A
32	2792.722 43(10)*	944.39	0.741E-22	Q(47) A	67	2796.813 74(9)*	251.34	0.111E-20	Q(24) A
33	2792.955 05(10)*	905.08	0.878E-22	Q(46) A	68	2796.932 11(9)*	231.24	0.118E-20	Q(23) A
34	2793.167 30(9)*	17.60	0.353E-21	P(6) A	69	2796.933 81(3)	689.55	0.516E-22	R(15) C
35	2793.182 68(10)*	866.60	0.104E-21	Q(45) A	70	2797.045 53(9)*	211.97	0.124E-20	Q(22) A

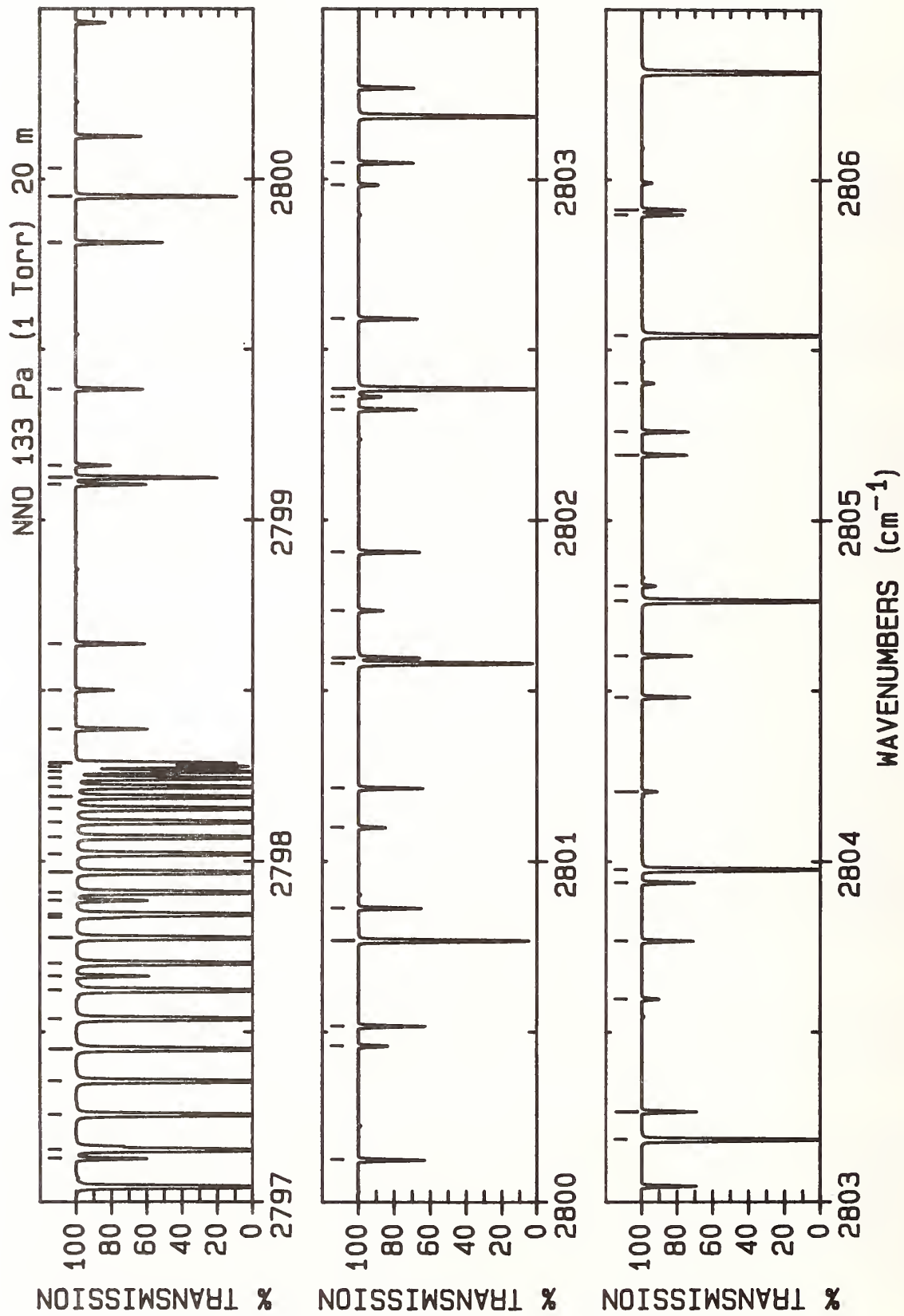

LINE #	WAVENUMBER(unc) (cm ⁻¹)	LOWER STATE (cm ⁻¹)	INTENSITY (cm/molecule)	ASSIGNMENT ROTATION BAND	LINE #	WAVENUMBER(unc) (cm ⁻¹)	LOWER STATE (cm ⁻¹)	INTENSITY (cm/molecule)	ASSIGNMENT ROTATION BAND
1	2797.128 27(3)	689.36	0.497E-22	R(15) B	36	2800.032 08(89)	1866.41	0.577E-24	R(40) E
2	2797.154 02(9)*	193.54	0.129E-20	Q(21) A	37	2800.125 46(3)	748.03	0.441E-22	R(19) B
3	2797.257 56(9)*	175.95	0.134E-20	Q(20) A	38	2800.459 62(5)	1058.86	0.177E-22	R(33) H
4	2797.356 17(9)*	159.20	0.139E-20	Q(19) A	39	2800.517 85(3)	765.12	0.451E-22	R(20) C
5	2797.449 83(9)*	143.28	0.142E-20	Q(18) A	40	2800.767 65(9)*	2.51	0.305E-21	R(2) A
6	2797.538 56(9)*	128.20	0.145E-20	Q(17) A	41	2800.863 06(3)	764.79	0.421E-22	R(20) B
7	2797.622 36(9)*	113.96	0.146E-20	Q(16) A	42	2801.100 02(5)	1087.34	0.160E-22	R(34) H
8	2797.663 66(3)	702.99	0.509E-22	R(16) C	43	2801.215 06(3)	782.76	0.431E-22	R(21) C
9	2797.701 22(9)*	100.55	0.146E-20	Q(15) A	44	2801.579 72(9)*	5.03	0.376E-21	R(3) A
10	2797.775 14(9)*	87.98	0.146E-20	Q(14) A	45	2801.596 03(3)	782.39	0.400E-22	R(21) B
11	2797.835 59(5)	953.32	0.251E-22	R(29) H	46	2801.734 07(5)	1116.65	0.145E-22	R(35) H
12	2797.844 13(9)*	76.25	0.143E-20	Q(13) A	47	2801.905 73(3)	801.23	0.410E-22	R(22) C
13	2797.884 63(3)	702.77	0.487E-22	R(16) B	48	2802.324 38(3)	800.83	0.377E-22	R(22) B
14	2797.908 20(9)*	65.36	0.140E-20	Q(12) A	49	2802.361 73(5)	1146.80	0.130E-22	R(36) H
15	2797.967 33(9)*	55.31	0.135E-20	Q(11) A	50	2802.385 30(9)*	8.38	0.444E-21	R(4) A
16	2798.021 52(9)*	46.09	0.129E-20	Q(10) A	51	2802.589 85(3)	820.54	0.388E-22	R(23) C
17	2798.070 80(9)*	37.71	0.122E-20	Q(9) A	52	2802.982 95(5)	1177.78	0.116E-22	R(37) H
18	2798.115 14(9)*	30.17	0.113E-20	Q(8) A	53	2803.048 15(3)	820.10	0.354E-22	R(23) B
19	2798.154 55(9)*	23.46	0.103E-20	Q(7) A	54	2803.184 38(9)*	12.57	0.508E-21	R(5) A
20	2798.189 03(9)*	17.60	0.919E-21	Q(6) A	55	2803.267 42(3)	840.68	0.364E-22	R(24) C
21	2798.218 59(9)*	12.57	0.797E-21	Q(5) A	56	2803.597 69(5)	1209.60	0.103E-22	R(38) H
22	2798.243 22(9)*	8.38	0.665E-21	Q(4) A	57	2803.767 35(3)	840.21	0.330E-22	R(24) B
23	2798.262 93(9)*	5.03	0.526E-21	Q(3) A	58	2803.938 42(3)	861.67	0.341E-22	R(25) C
24	2798.277 71(9)*	2.51	0.380E-21	Q(2) A	59	2803.976 94(9)*	17.60	0.567E-21	R(6) A
25	2798.287 56(9)*	0.84	0.230E-21	Q(1) A	60	2804.205 90(5)	1242.25	0.907E-23	R(39) H
26	2798.387 00(3)	717.26	0.498E-22	R(17) C	61	2804.482 02(3)	861.16	0.306E-22	R(25) B
27	2798.500 88(5)	978.45	0.232E-22	R(30) H	62	2804.602 87(3)	883.50	0.317E-22	R(26) C
28	2798.636 27(3)	717.02	0.474E-22	R(17) B	63	2804.763 00(9)*	23.46	0.620E-21	R(7) A
29	2799.103 81(3)	732.38	0.485E-22	R(18) C	64	2804.807 53(5)	1275.74	0.798E-23	R(40) H
30	2799.124 02(9)*	0.00	0.154E-21	R(0) A	65	2805.192 17(3)	882.94	0.283E-22	R(26) B
31	2799.160 01(5)	1004.42	0.213E-22	R(31) H	66	2805.260 74(3)	906.16	0.294E-22	R(27) C
32	2799.383 21(3)	732.11	0.459E-22	R(18) B	67	2805.402 53(5)	1310.06	0.699E-23	R(41) H
33	2799.812 94(5)	1031.22	0.195E-22	R(32) H	68	2805.542 54(9)*	30.17	0.667E-21	R(8) A
34	2799.814 10(3)	748.33	0.469E-22	R(19) C	69	2805.897 85(3)	905.56	0.259E-22	R(27) B
35	2799.949 08(9)*	0.84	0.230E-21	R(1) A	70	2805.912 05(3)	929.66	0.270E-22	R(28) C

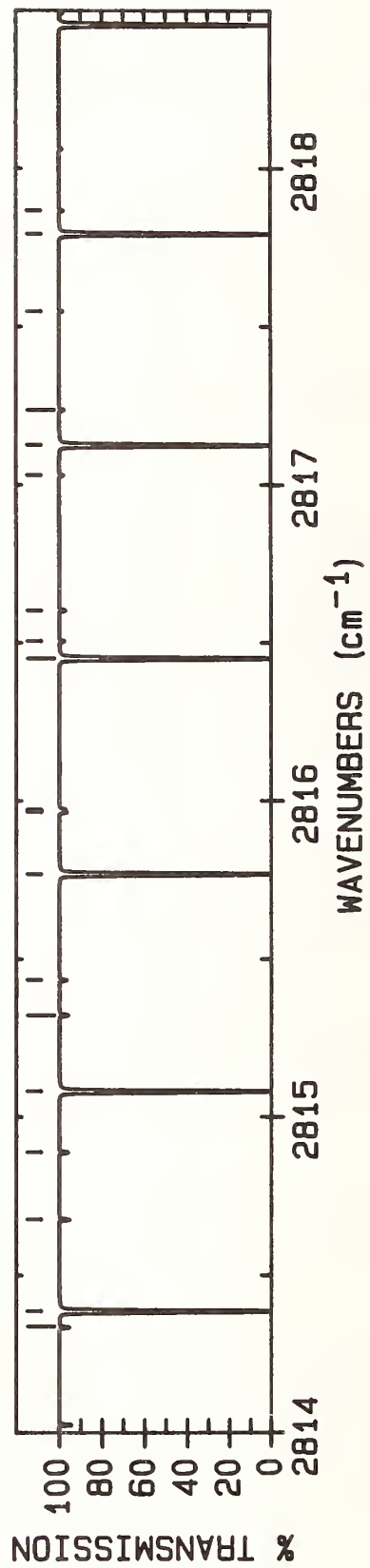
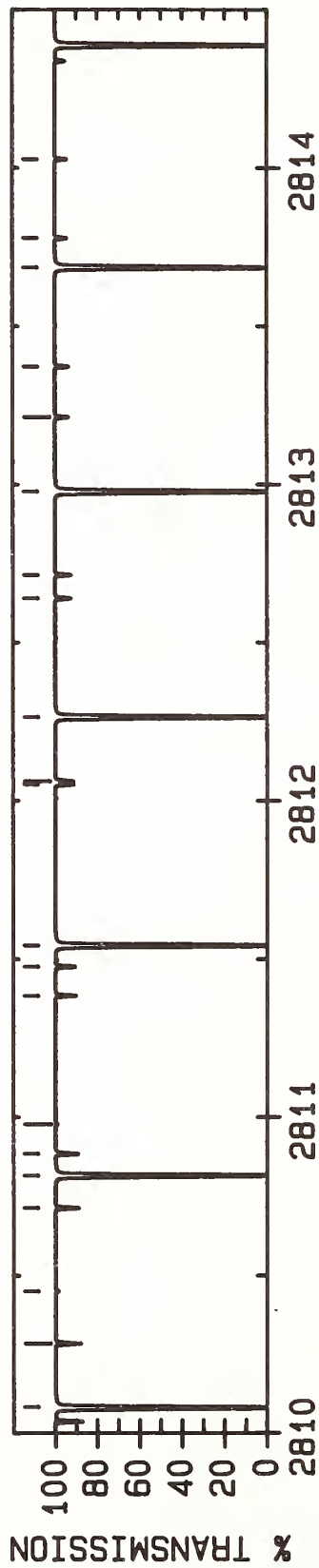
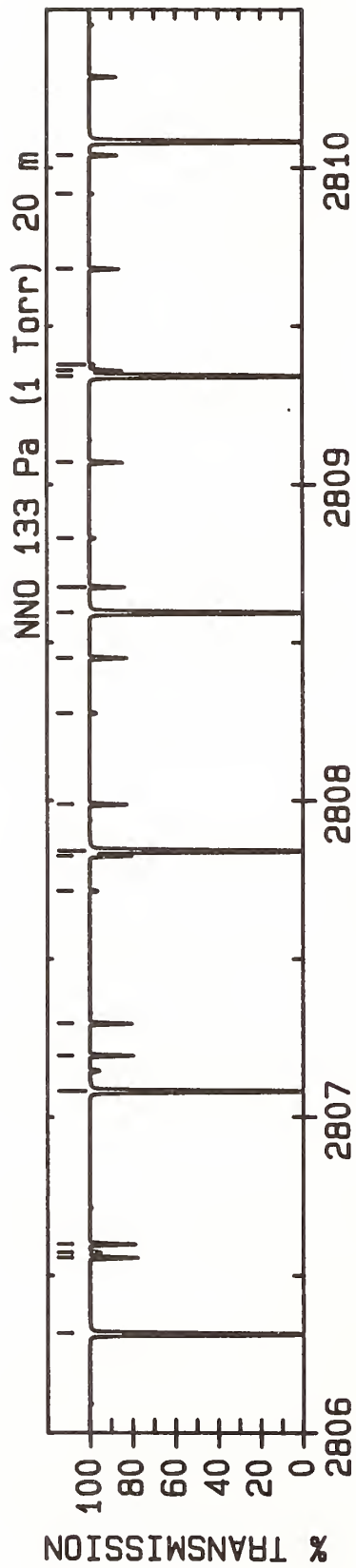

LINE #	WAVENUMBER(unc) (cm ⁻¹)	LOWER STATE (cm ⁻¹)	INTENSITY (cm/molecule)	ASSIGNMENT ROTATION BAND	LINE #	WAVENUMBER(unc) (cm ⁻¹)	LOWER STATE (cm ⁻¹)	INTENSITY (cm/molecule)	ASSIGNMENT ROTATION BAND
1	2806.315 57(9)*	37.71	0.707E-21	R(9) A	36	2812.264 47(9)*	128.20	0.789E-21	R(17) A
2	2806.556 77(3)	954.01	0.248E-22	R(29) C	37	2812.640 88(4)	1243.48	0.791E-23	R(39) C
3	2806.572 45(5)	1381.21	0.528E-23	R(43) H	38	2812.714 49(4)	1177.78	0.814E-23	R(37) B
4	2806.599 07(3)	929.02	0.236E-22	R(28) B	39	2812.978 61(9)*	143.28	0.772E-21	R(18) A
5	2807.082 07(9)*	46.09	0.741E-21	R(10) A	40	2813.212 86(4)	1277.04	0.688E-23	R(40) C
6	2807.194 90(4)	979.18	0.226E-22	R(30) C	41	2813.372 79(4)	1209.60	0.705E-23	R(38) B
7	2807.295 87(3)	953.32	0.214E-22	R(29) B	42	2813.686 17(9)*	159.20	0.750E-21	R(19) A
8	2807.715 31(5)	1455.70	0.392E-23	R(45) H	43	2813.778 20(5)	1311.42	0.595E-23	R(41) C
9	2807.826 45(4)	1005.20	0.205E-22	R(31) C	44	2814.026 97(5)	1242.25	0.608E-23	R(39) B
10	2807.842 03(9)*	55.31	0.768E-21	R(11) A	45	2814.336 88(5)	1346.65	0.513E-23	R(42) C
11	2807.988 27(3)	978.45	0.193E-22	R(30) B	46	2814.387 16(9)*	175.95	0.724E-21	R(20) A
12	2808.276 47(6)	1494.20	0.335E-23	R(46) H	47	2814.677 04(5)	1275.74	0.521E-23	R(40) B
13	2808.451 40(4)	1032.06	0.185E-22	R(32) C	48	2814.888 90(5)	1382.71	0.440E-23	R(43) C
14	2808.595 47(9)*	65.36	0.788E-21	R(12) A	49	2815.081 58(9)*	193.54	0.696E-21	R(21) A
15	2808.676 31(3)	1004.42	0.174E-22	R(31) B	50	2815.323 04(5)	1310.06	0.444E-23	R(41) B
16	2808.830 73(6)	1533.53	0.286E-23	R(47) H	51	2815.434 26(5)	1419.61	0.376E-23	R(44) C
17	2809.069 74(4)	1059.75	0.166E-22	R(33) C	52	2815.769 41(9)*	211.97	0.664E-21	R(22) A
18	2809.342 37(9)*	76.25	0.801E-21	R(13) A	53	2815.964 99(5)	1345.22	0.377E-23	R(42) B
19	2809.360 01(3)	1031.22	0.155E-22	R(32) B	54	2815.972 95(5)	1457.34	0.319E-23	R(45) C
20	2809.378 06(6)	1573.69	0.242E-23	R(48) H	55	2816.450 66(9)*	231.24	0.630E-21	R(23) A
21	2809.681 48(4)	1088.28	0.149E-22	R(34) C	56	2816.504 97(5)	1495.90	0.270E-23	R(46) C
22	2809.918 39(7)	1614.68	0.204E-23	R(49) H	57	2816.602 93(5)	1381.21	0.319E-23	R(43) B
23	2810.039 40(3)	1058.86	0.138E-22	R(33) B	58	2817.030 30(5)	1535.31	0.227E-23	R(47) C
24	2810.082 72(9)*	87.98	0.807E-21	R(14) A	59	2817.125 31(9)*	251.34	0.594E-21	R(24) A
25	2810.286 61(4)	1117.64	0.132E-22	R(35) C	60	2817.236 87(5)	1418.04	0.268E-23	R(44) B
26	2810.451 70(7)	1656.51	0.172E-23	R(50) H	61	2817.548 95(5)	1575.55	0.191E-23	R(48) C
27	2810.714 51(4)	1087.34	0.122E-22	R(34) B	62	2817.793 37(9)*	272.28	0.557E-21	R(25) A
28	2810.816 53(9)*	100.55	0.807E-21	R(15) A	63	2817.866 84(6)	1455.70	0.224E-23	R(45) B
29	2810.885 12(4)	1147.85	0.117E-22	R(36) C					
30	2810.977 95(8)	1699.17	0.143E-23	R(51) H					
31	2811.385 38(4)	1116.65	0.107E-22	R(35) B					
32	2811.477 01(4)	1178.89	0.103E-22	R(37) C					
33	2811.543 78(9)*	113.96	0.800E-21	R(16) A					
34	2812.052 03(4)	1146.80	0.936E-23	R(36) B					
35	2812.062 26(4)	1210.77	0.906E-23	R(38) C					

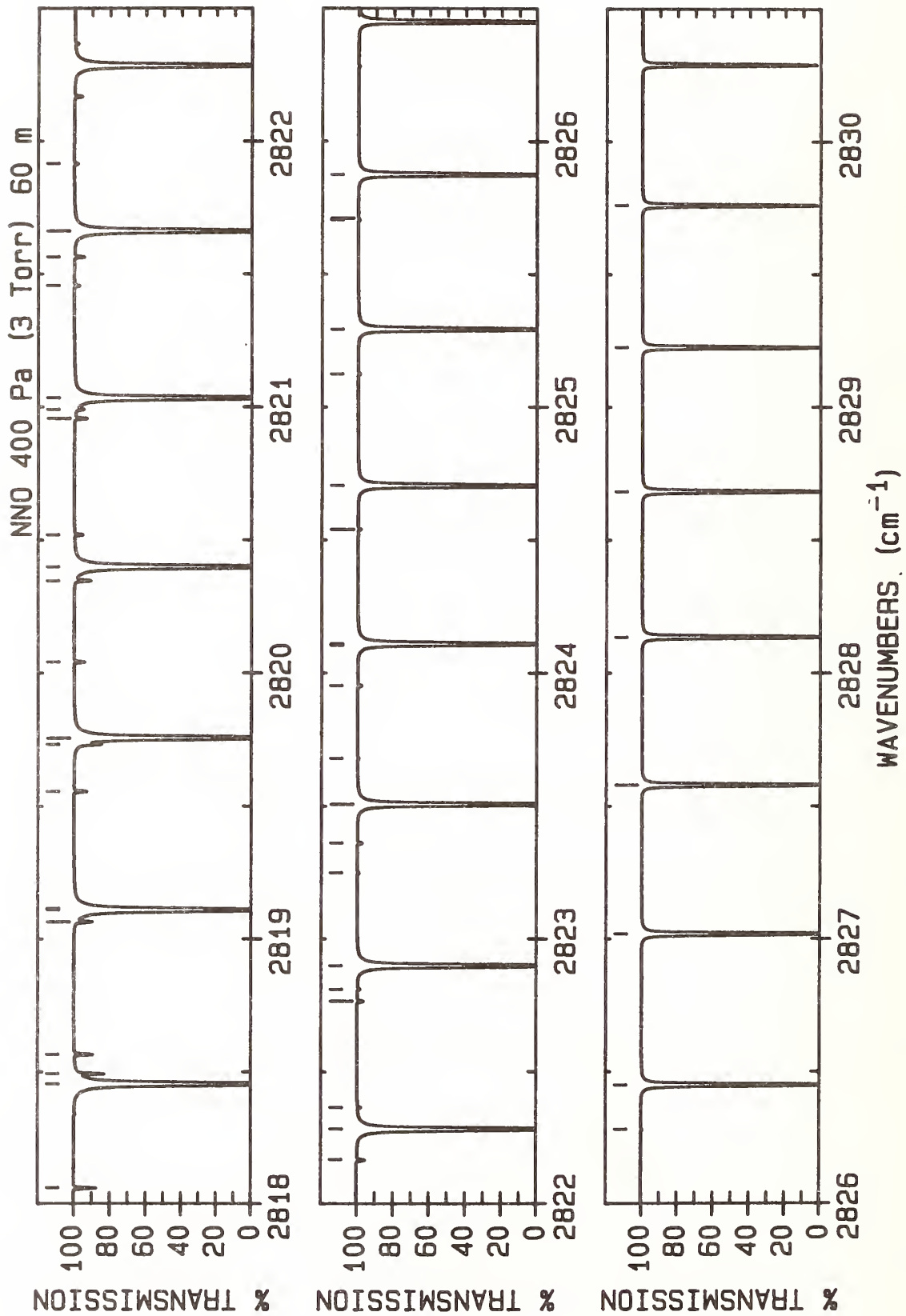

LINE #	WAVENUMBER(cm^{-1})	LOWER STATE (cm^{-1})	INTENSITY (cm^2/mole)	ASSIGNMENT ROTATION BAND	LINE #	WAVENUMBER(unc) (cm^{-1})	LOWER STATE (cm^{-1})	INTENSITY (cm^2/mole)	ASSIGNMENT ROTATION BAND
1	2818.060 90(5)	1616.62	0.159E-23	R(49) C	26	2822.810 97(13)	2073.21	0.206E-24	R(59) C
2	2818.454 82(9)*	294.06	0.520E-21	R(26) A	27	2822.899 69(9)*	469.91	0.277E-21	R(33) A
3	2818.492 87(6)	1494.20	0.187E-23	R(46) B	28	2823.248 89(14)	2123.45	0.164E-24	R(60) C
4	2818.566 16(6)	1658.53	0.132E-23	R(50) C	29	2823.361 48(8)	1832.15	0.363E-24	R(54) B
5	2819.064 70(6)	1701.27	0.110E-23	R(51) C	30	2823.508 13(9)*	498.37	0.248E-21	R(34) A
6	2819.109 67(9)*	316.67	0.483E-21	R(27) A	31	2823.680 05(16)	2174.53	0.130E-24	R(61) C
7	2819.114 97(6)	1533.53	0.155E-23	R(47) B	32	2823.952 86(9)	1878.14	0.290E-24	R(55) B
8	2819.556 54(7)	1744.84	0.903E-24	R(52) C	33	2824.104 44(17)	2226.43	0.102E-24	R(62) C
9	2819.733 18(6)	1573.69	0.128E-23	R(48) B	34	2824.109 93(9)*	527.67	0.221E-21	R(35) A
10	2819.757 90(9)*	340.12	0.446E-21	R(28) A	35	2824.540 45(10)	1924.97	0.230E-24	R(56) B
11	2820.041 66(7)	1789.25	0.741E-24	R(53) C	36	2824.705 06(9)*	557.81	0.196E-21	R(36) A
12	2820.347 50(6)	1614.68	0.105E-23	R(49) B	37	2825.124 27(11)	1972.62	0.182E-24	R(57) B
13	2820.399 52(9)*	364.41	0.409E-21	R(29) A	38	2825.293 54(9)*	588.78	0.173E-21	R(37) A
14	2820.520 06(8)	1834.50	0.605E-24	R(54) C	39	2825.704 33(12)	2021.11	0.143E-24	R(58) B
15	2820.957 96(7)	1656.51	0.855E-24	R(50) B	40	2825.711 2	4009.87	0.421E-28	R(90) H
16	2820.991 72(9)	1880.57	0.492E-24	R(55) C	41	2825.875 35(9)*	620.59	0.152E-21	R(38) A
17	2821.034 51(9)*	389.53	0.374E-21	R(30) A	42	2826.280 62(13)	2070.42	0.112E-24	R(59) B
18	2821.456 65(9)	1927.48	0.398E-24	R(56) C	43	2826.450 49(9)*	653.23	0.133E-21	R(39) A
19	2821.564 57(7)	1699.17	0.695E-24	R(51) B	44	2827.018 94(9)*	686.70	0.116E-21	R(40) A
20	2821.662 87(9)*	415.49	0.340E-21	R(31) A	45	2827.580 72(9)*	721.01	0.101E-21	R(41) A
21	2821.914 84(10)	1975.23	0.321E-24	R(57) C	46	2828.135 81(9)*	756.16	0.868E-22	R(42) A
22	2822.167 35(7)	1742.67	0.562E-24	R(52) B	47	2828.684 20(9)*	792.14	0.745E-22	R(43) A
23	2822.284 60(9)*	442.28	0.308E-21	R(32) A	48	2829.225 89(10)*	828.95	0.637E-22	R(44) A
24	2822.366 28(12)	2023.80	0.258E-24	R(58) C	49	2829.760 87(10)*	866.60	0.542E-22	R(45) A
25	2822.766 32(8)	1786.99	0.453E-24	R(53) B					

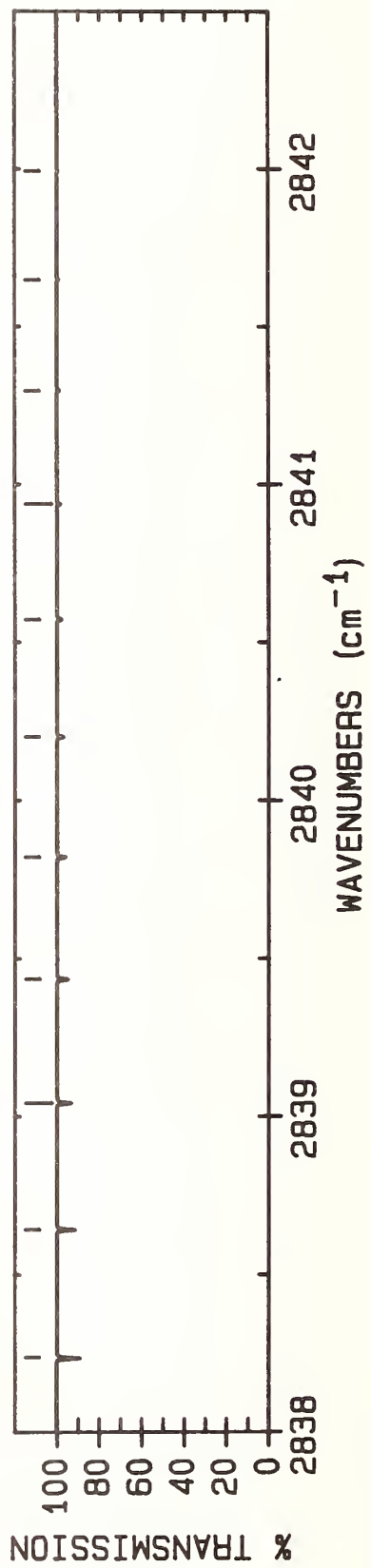
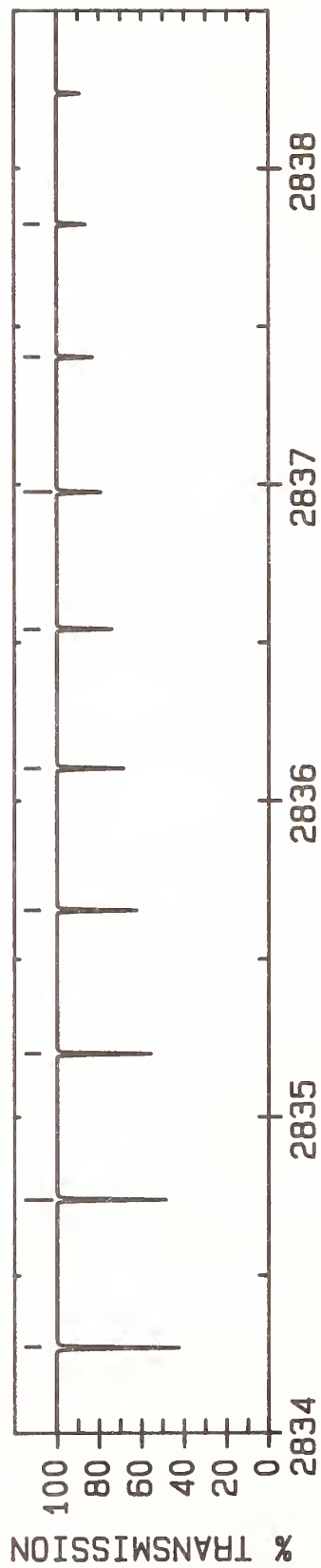
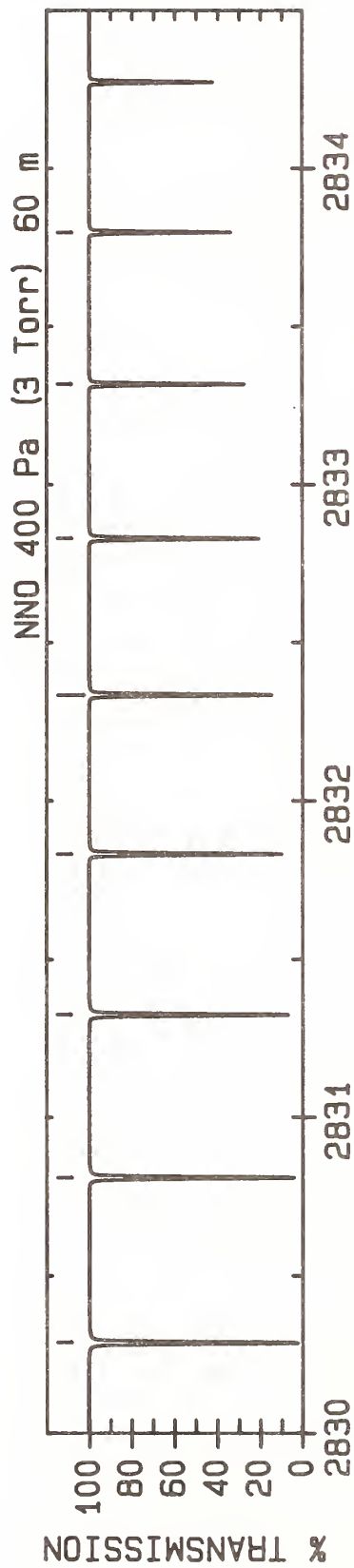

LINE #	WAVENUMBER(unc) (cm ⁻¹)	LOWER STATE (cm ⁻¹)	INTENSITY (cm/molecule)	ASSIGNMENT ROTATION BAND	LINE #	WAVENUMBER(unc) (cm ⁻¹)	LOWER STATE (cm ⁻¹)	INTENSITY (cm/molecule)	ASSIGNMENT ROTATION BAND
1	2830.289 14(10)*	905.08	0.459E-22	R(46) A	16	2837.403 75(14)*	1582.18	0.225E-23	R(61) A
2	2830.810 70(10)*	944.39	0.387E-22	R(47) A	17	2837.823 82(15)*	1633.97	0.178E-23	R(62) A
3	2831.325 53(10)*	984.54	0.325E-22	R(48) A	18	2838.237 07(15)*	1686.59	0.140E-23	R(63) A
4	2831.833 63(10)*	1025.52	0.272E-22	R(49) A	19	2838.643 51(16)*	1740.04	0.109E-23	R(64) A
5	2832.334 99(10)*	1067.33	0.226E-22	R(50) A	20	2839.043 12(16)*	1794.32	0.853E-24	R(65) A
6	2832.829 61(11)*	1109.98	0.187E-22	R(51) A	21	2839.435 89(17)*	1849.42	0.663E-24	R(66) A
7	2833.317 49(11)*	1153.46	0.155E-22	R(52) A	22	2839.821 83(17)*	1905.36	0.512E-24	R(67) A
8	2833.798 61(11)*	1197.77	0.127E-22	R(53) A	23	2840.200 92(18)*	1962.12	0.395E-24	R(68) A
9	2834.272 97(11)*	1242.91	0.104E-22	R(54) A	24	2840.573 16(19)*	2019.71	0.303E-24	R(69) A
10	2834.740 57(12)*	1288.88	0.846E-23	R(55) A	25	2840.938 54(20)*	2078.13	0.231E-24	R(70) A
11	2835.201 40(12)*	1335.69	0.686E-23	R(56) A	26	2841.297 06(20)*	2137.38	0.176E-24	R(71) A
12	2835.655 45(12)*	1383.33	0.553E-23	R(57) A	27	2841.648 70(21)*	2197.45	0.133E-24	R(72) A
13	2836.102 71(13)*	1431.79	0.445E-23	R(58) A	28	2841.993 47(22)*	2258.36	0.100E-24	R(73) A
14	2836.543 19(13)*	1481.09	0.356E-23	R(59) A					
15	2836.976 87(14)*	1531.22	0.283E-23	R(60) A					

ATLAS OF CS₂ ABSORPTION LINES FROM 1460 cm⁻¹ to 1551 cm⁻¹

key:

Band	Isotopomer	Vibrational Transition
A	³² S ¹² C ³² S	00 ⁰ 1-00 ⁰ 0
B		01 ¹ 1-01 ^{1e} 0
C		01 ¹ 1-01 ^{1f} 0
D		10 ⁰ 1-10 ⁰ 0
E		02 ² 1-02 ^{2e} 0
F		02 ² 1-02 ^{2f} 0
G		02 ⁰ 1-02 ⁰ 0
H		11 ¹ 1-11 ^{1e} 0
I		11 ¹ 1-11 ^{1f} 0
M	³⁴ S ¹² C ³² S	00 ⁰ 1-00 ⁰ 0
N		01 ¹ 1-01 ^{1e} 0
O		01 ¹ 1-01 ^{1f} 0
P		10 ⁰ 1-10 ⁰ 0
Q	³³ S ¹² C ³² S	00 ⁰ 1-00 ⁰ 0
R		01 ¹ 1-01 ^{1e} 0
S		01 ¹ 1-01 ^{1f} 0
V	³⁴ S ¹² C ³⁴ S	00 ⁰ 1-00 ⁰ 0
a	³² S ¹³ C ³² S	00 ⁰ 1-00 ⁰ 0
b		01 ¹ 1-01 ^{1e} 0
c		01 ¹ 1-01 ^{1f} 0
d		10 ⁰ 1-10 ⁰ 0
m	³⁴ S ¹³ C ³² S	00 ⁰ 1-00 ⁰ 0

If the e or f designation is not specified (for $l \neq 0$), then the transition is to either level, depending on the selection rules and the change in the rotational quantum number, J . Spectra are given for a slitwidth of 0.002 cm⁻¹, a temperature of 296 K, and a transition moment of 0.27 debye. No Herman-Wallis constant was included in the intensity calculation.

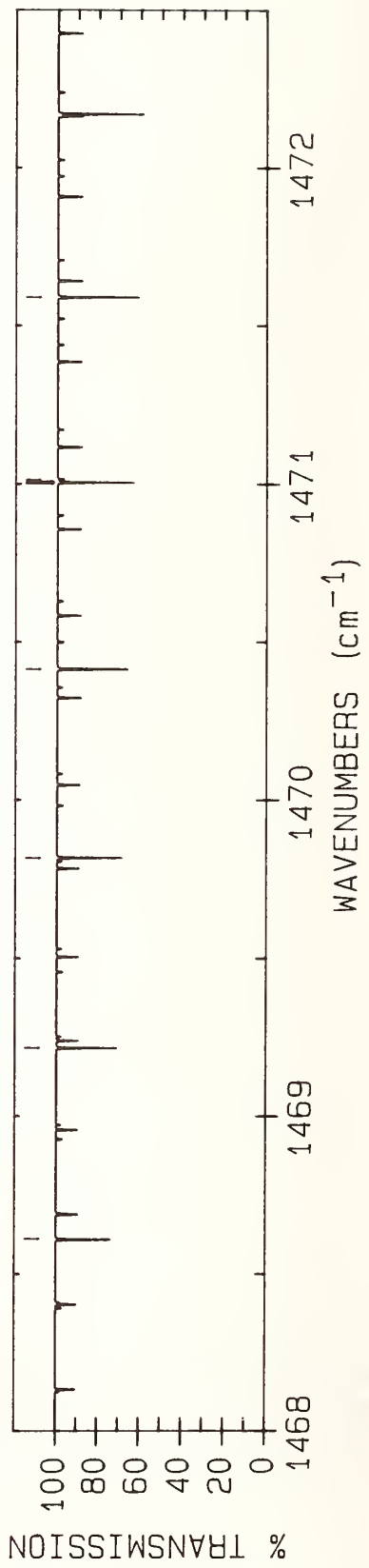
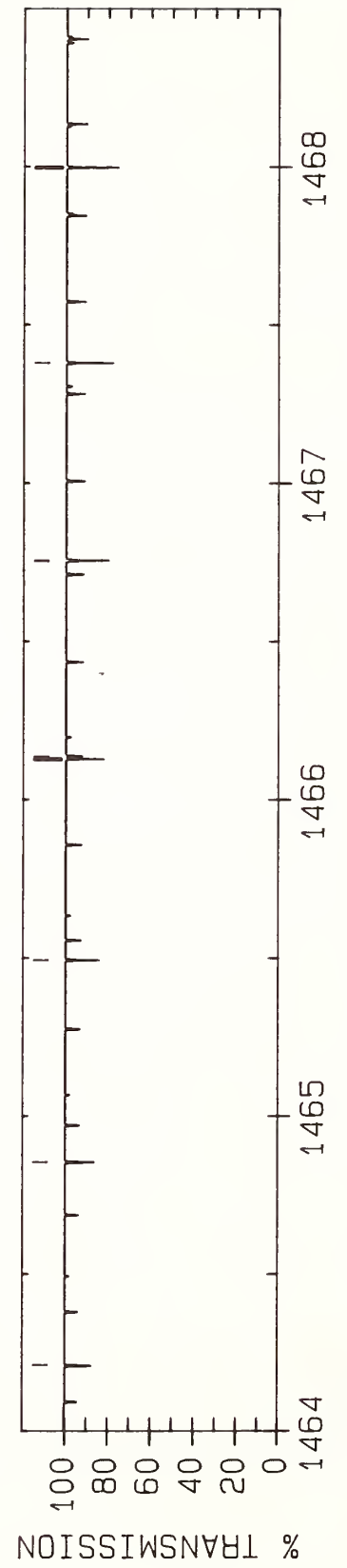
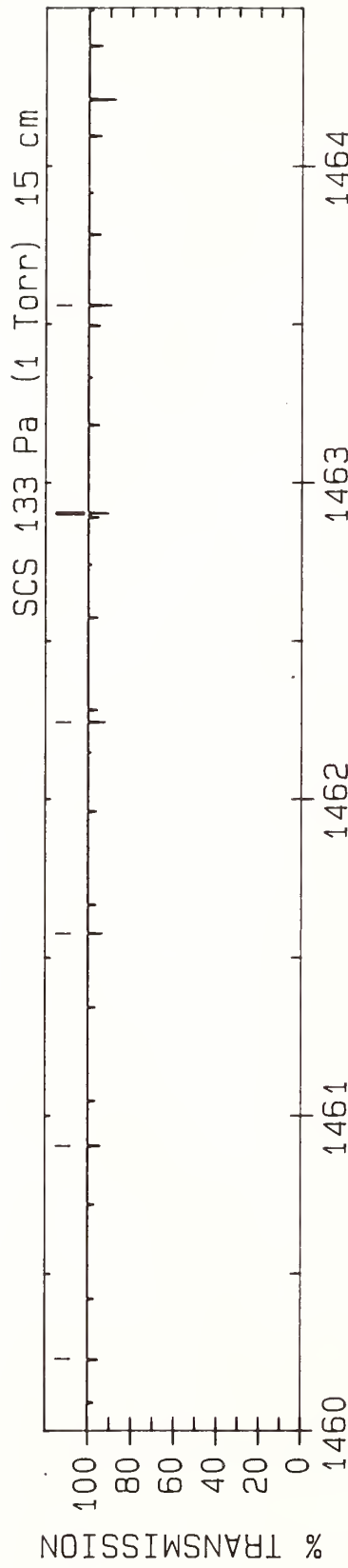

LINE #	WAVENUMBER(unc) (cm ⁻¹)	LOWER STATE (cm ⁻¹)	INTENSITY (cm/molecule)	ASSIGNMENT ROTATION BAND	LINE #	WAVENUMBER(unc) (cm ⁻¹)	LOWER STATE (cm ⁻¹)	INTENSITY (cm/molecule)	ASSIGNMENT ROTATION BAND
1	1460.228 08(15)*	892.98	0.377E-21	P(90)	16	1468.609 40(11)*	453.77	0.228E-20	P(64)
2	1460.905 18(14)*	853.98	0.445E-21	P(88)	17	1469.216 27(10)*	426.08	0.252E-20	P(62)
3	1461.576 88(13)*	815.85	0.524E-21	P(86)	18	1469.817 73(10)*	399.26	0.278E-20	P(60)
4	1462.243 20(12)*	778.59	0.614E-21	P(84)	19	1470.413 77(10)*	373.30	0.306E-20	P(58)
5	1462.904 12(12)*	742.19	0.715E-21	P(82)	20	1471.004 38(10)*	348.22	0.333E-20	P(56)
6	1463.559 65(12)*	706.67	0.830E-21	P(80)	21	1471.013 5	745.49	0.241E-21	P(28)
7	1464.209 78(11)*	672.01	0.958E-21	P(78)	22	1471.589 57(9)*	324.01	0.362E-20	P(54)
8	1464.854 51(11)*	638.22	0.110E-20	P(76)					
9	1465.493 84(11)*	605.31	0.126E-20	P(74)					
10	1466.127 77(11)*	573.26	0.143E-20	P(72)					
11	1466.136 6	684.34	0.603E-21	P(52)					
12	1466.753 4	872.74	0.204E-21	P(44)					
13	1466.756 29(11)*	542.08	0.162E-20	P(70)					
14	1467.379 40(11)*	511.78	0.182E-20	P(68)					
15	1467.997 11(11)*	482.34	0.204E-20	P(66)					

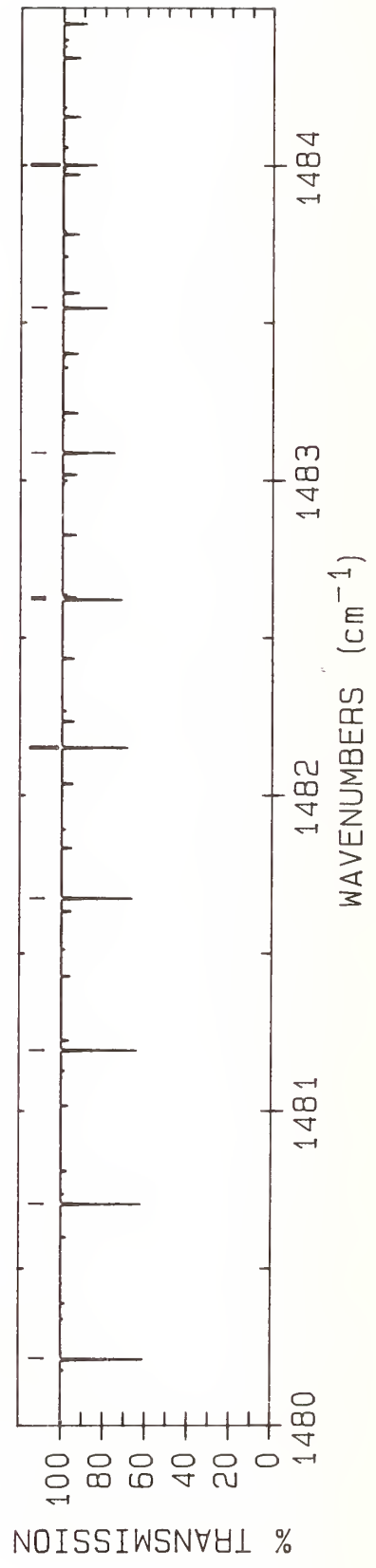
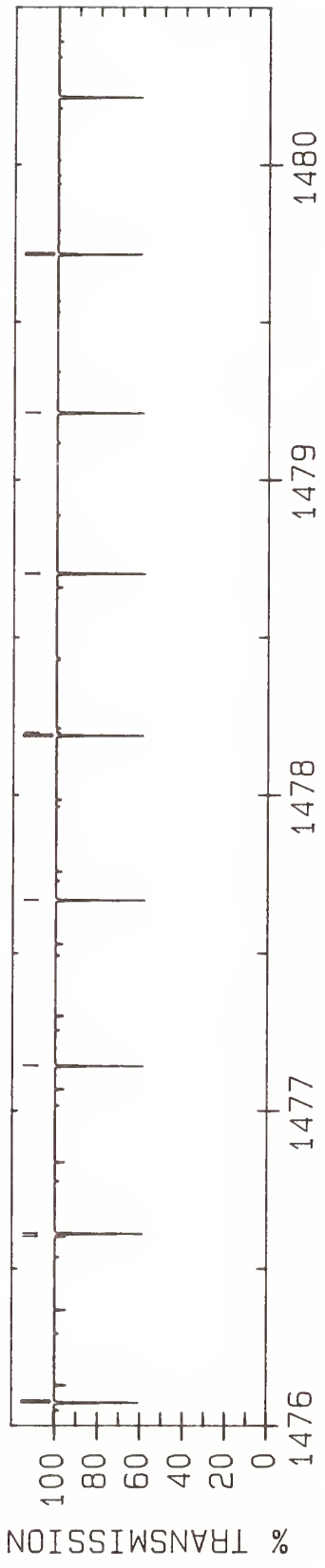
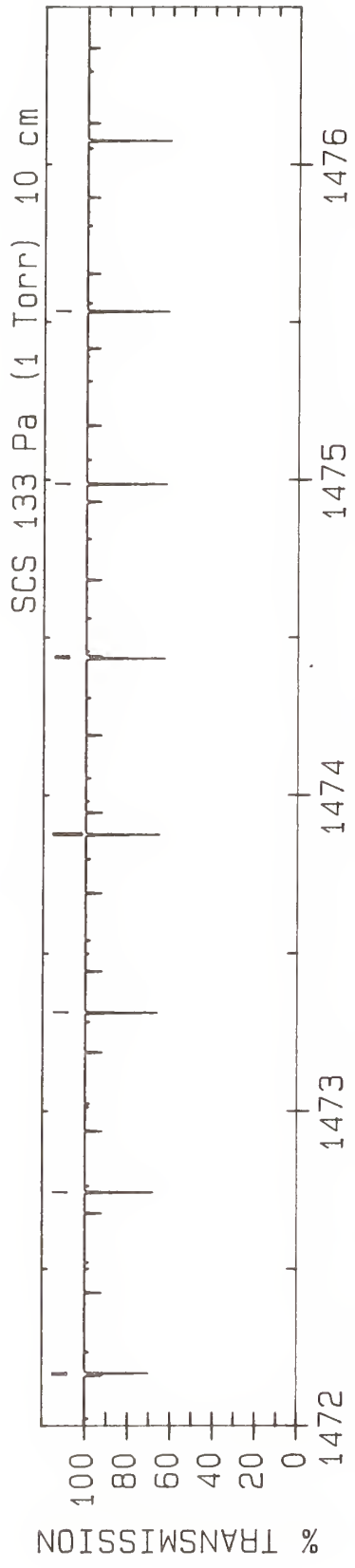

LINE #	WAVENUMBER(unc) (cm ⁻¹)	LOWER STATE (cm ⁻¹)	INTENSITY (cm/molecule)	ASSIGNMENT ROTATION BAND	LINE #	WAVENUMBER(unc) (cm ⁻¹)	LOWER STATE (cm ⁻¹)	INTENSITY (cm/molecule)	ASSIGNMENT ROTATION BAND
1	1472.162 0	484.71	0.922E-21	P(30) c	16	1478.196 7	28.80	0.194E-21	P(16) m
2	1472.169 34(9)*	300.67	0.390E-20	P(52) a	17	1478.701 2	659.18	0.659E-22	R(4) d
3	1472.743 68(9)*	278.20	0.419E-20	P(50) a	18	1478.702 46(8)*	88.61	0.592E-20	P(28) a
4	1473.312 59(9)*	256.61	0.447E-20	P(48) a	19	1479.211 48(8)*	76.60	0.583E-20	P(26) a
5	1473.876 06(8)*	235.88	0.474E-20	P(46) a	20	1479.715 04(8)*	65.47	0.568E-20	P(24) a
6	1474.434 10(8)*	216.03	0.499E-20	P(44) a	21	1480.213 14(8)*	55.22	0.548E-20	P(22) a
7	1474.441 2	433.49	0.828E-21	P(21) b	22	1480.705 78(8)*	45.83	0.521E-20	P(20) a
8	1474.986 70(8)*	197.05	0.523E-20	P(42) a	23	1481.192 95(8)*	37.32	0.489E-20	P(18) a
9	1475.533 86(8)*	178.94	0.544E-20	P(40) a	24	1481.674 66(9)*	29.68	0.451E-20	P(16) a
10	1476.075 58(8)*	161.70	0.562E-20	P(38) a	25	1482.150 90(9)*	22.92	0.408E-20	P(14) a
11	1476.602 8	400.06	0.555E-21	P(12) c	26	1482.621 66(9)*	17.02	0.360E-20	P(12) a
12	1476.611 85(8)*	145.34	0.577E-20	P(36) a	27	1482.629 3	409.23	0.712E-21	R(15) b
13	1477.142 68(7)*	129.85	0.588E-20	P(34) a	28	1483.086 96(9)*	12.00	0.308E-20	P(10) a
14	1477.668 06(7)*	115.23	0.594E-20	P(32) a	29	1483.546 77(9)*	7.86	0.251E-20	P(8) a
15	1478.187 99(8)*	101.48	0.596E-20	P(30) a	30	1484.001 11(9)*	4.58	0.192E-20	P(6) a

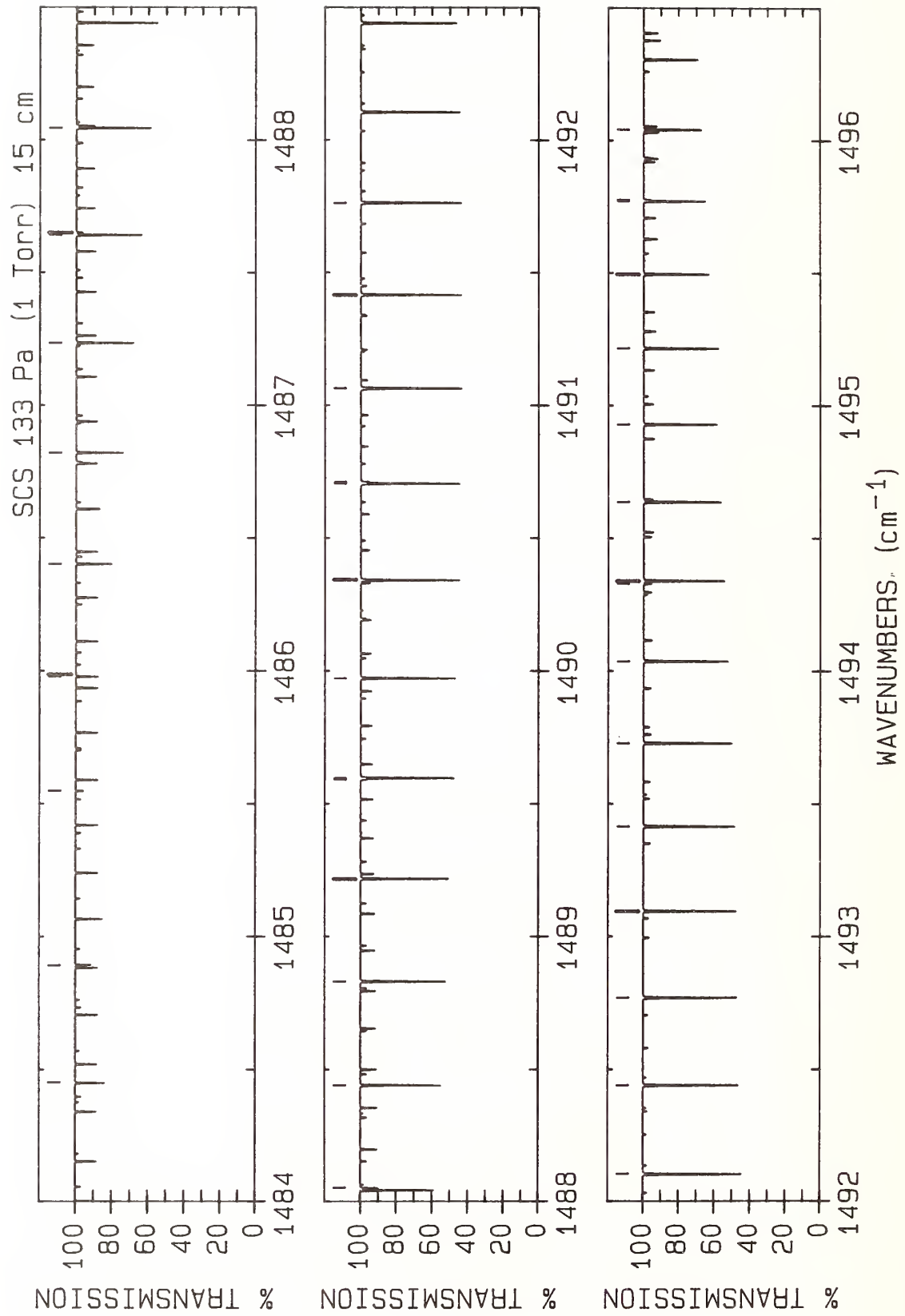

LINE #	WAVENUMBER(unc) (cm ⁻¹)	LOWER STATE (cm ⁻¹)	INTENSITY (cm/molecule)	ASSIGNMENT ROTATION BAND	LINE #	WAVENUMBER(unc) (cm ⁻¹)	LOWER STATE (cm ⁻¹)	INTENSITY (cm/molecule)	ASSIGNMENT ROTATION BAND
1	1484.449 97(9)*	2.18	0.129E-20	P(4) a	26	1491.762 50(8)*	115.23	0.619E-20	R(32) a
2	1484.893 34(9)*	0.66	0.651E-21	P(2) a	27	1492.104 04(8)*	129.85	0.611E-20	R(34) a
3	1485.548 12(9)*	0.00	0.327E-21	R(0) a	28	1492.440 05(8)*	145.34	0.599E-20	R(36) a
4	1485.977 78(9)*	0.66	0.977E-21	R(2) a	29	1492.770 53(9)*	161.70	0.583E-20	R(38) a
5	1485.986 3	2531.48	0.206E-22	P(152) A	30	1493.095 48(9)*	178.94	0.564E-20	R(40) a
6	1486.401 94(9)*	2.18	0.162E-20	R(4) a	31	1493.414 89(10)*	197.05	0.542E-20	R(42) a
7	1486.820 62(9)*	4.58	0.224E-20	R(6) a	32	1493.728 77(10)*	216.03	0.517E-20	R(44) a
8	1487.233 80(9)*	7.86	0.283E-20	R(8) a	33	1494.037 11(10)*	235.88	0.491E-20	R(46) a
9	1487.641 48(9)*	12.00	0.339E-20	R(10) a	34	1494.329 18(30)	1912.19	0.366E-21	P(132) A
10	1487.650 4	98.48	0.270E-21	R(30) m	35	1494.339 92(11)*	256.61	0.463E-20	R(48) a
11	1488.043 66(9)*	17.02	0.392E-20	R(12) a	36	1494.637 18(11)*	278.20	0.434E-20	R(50) a
12	1488.051 6	619.41	0.759E-21	R(46) c	37	1494.928 89(12)*	300.67	0.404E-20	R(52) a
13	1488.440 34(8)*	22.92	0.439E-20	R(14) a	38	1495.215 06(12)*	324.01	0.375E-20	R(54) a
14	1488.831 52(8)*	29.68	0.482E-20	R(16) a	39	1495.215 3	1820.63	0.417E-21	P(96) G
15	1489.217 19(8)*	37.32	0.519E-20	R(18) a	40	1495.495 68(13)*	348.22	0.345E-20	R(56) a
16	1489.591 7	191.24	0.239E-21	R(42) m	41	1495.770 74(13)*	373.30	0.316E-20	R(58) a
17	1489.597 35(8)*	45.83	0.551E-20	R(20) a	42	1495.775 6	1939.14	0.262E-21	P(108) D
18	1489.972 00(8)*	55.22	0.576E-20	R(22) a	43	1496.040 25(14)*	399.26	0.288E-20	R(60) a
19	1490.341 13(8)*	65.47	0.596E-20	R(24) a					
20	1490.343 7	238.88	0.211E-21	R(47) m					
21	1490.704 75(8)*	76.60	0.610E-20	R(26) a					
22	1490.710 9	851.65	0.345E-21	R(65) b					
23	1491.062 2	291.81	0.181E-21	R(52) m					
24	1491.062 86(8)*	88.61	0.618E-20	R(28) a					
25	1491.415 44(8)*	101.48	0.621E-20	R(30) a					

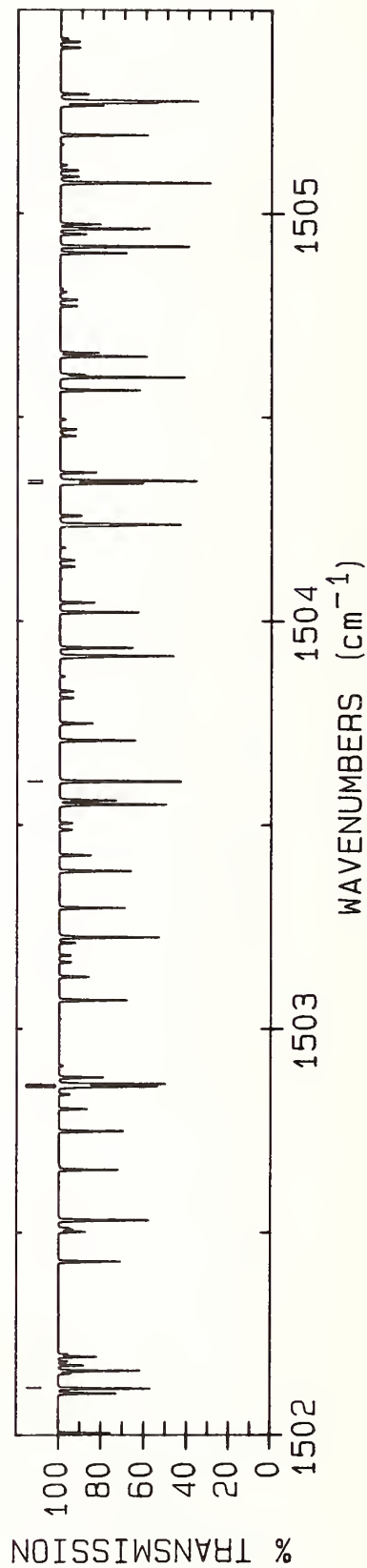
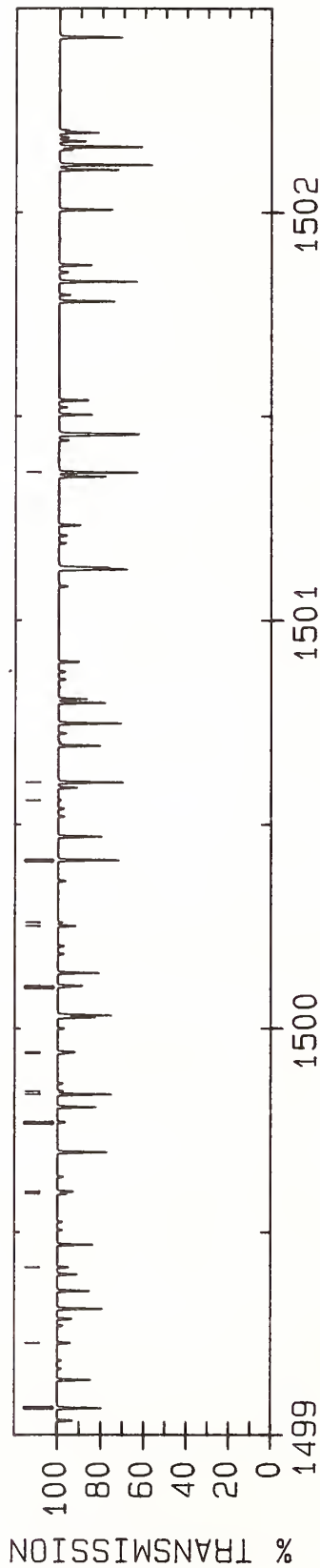
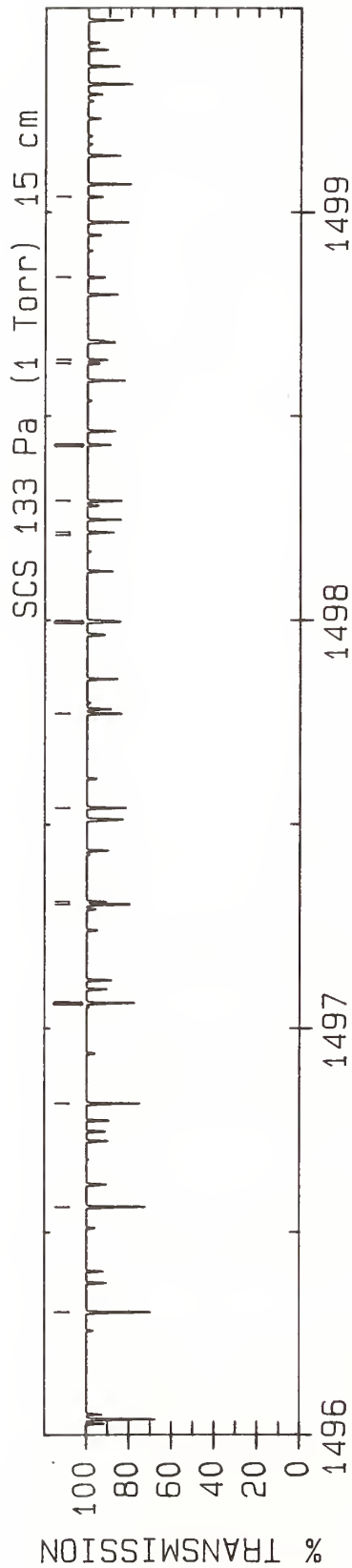

LINE #	WAVENUMBER(unc) (cm ⁻¹)	LOWER STATE (cm ⁻¹)	INTENSITY (cm/molecule)	ASSIGNMENT ROTATION BAND	LINE #	WAVENUMBER(unc) (cm ⁻¹)	LOWER STATE (cm ⁻¹)	INTENSITY (cm/molecule)	ASSIGNMENT ROTATION BAND
1	1496.303 0	1560.99	0.792E-22	P(121) M	26	1499.838 79(11)*	1530.03	0.210E-20	P(118) A
2	1496.304 21(14)*	426.08	0.261E-20	R(62) a	27	1499.845 8	1323.11	0.194E-21	P(93) O
3	1496.562 61(15)*	453.77	0.236E-20	R(64) a	28	1499.939 22(14)*	1015.20	0.230E-21	R(96) a
4	1496.815 45(15)*	482.34	0.211E-20	R(66) a	29	1499.942 3	1701.27	0.597E-21	P(77) H
5	1497.062 72(15)*	511.78	0.189E-20	R(68) a	30	1500.102 78(14)*	1057.67	0.191E-21	R(98) a
6	1497.304 43(15)*	542.08	0.168E-20	R(70) a	31	1500.105 6	1671.70	0.858E-21	P(96) D
7	1497.311 4	1698.00	0.710E-21	P(90) G	32	1500.252 5	1684.98	0.638E-21	P(76) I
8	1497.540 58(15)*	573.26	0.148E-20	R(72) a	33	1500.260 75(16)*	1101.01	0.158E-21	R(100) a
9	1497.771 15(15)*	605.31	0.130E-20	R(74) a	34	1500.413 11(17)*	1145.22	0.130E-21	R(102) a
10	1497.996 15(15)*	638.22	0.114E-20	R(76) a	35	1500.414 0	1476.90	0.229E-20	P(99) B
11	1497.998 9	1658.87	0.840E-21	P(88) G	36	1500.559 87(19)*	1190.29	0.106E-21	R(104) a
12	1498.208 8	1532.34	0.162E-22	P(119) Q	37	1500.603 61(11)*	1478.89	0.265E-20	P(116) A
13	1498.215 58(15)*	672.01	0.993E-21	R(78) a	38	1501.362 86(10)*	1428.62	0.333E-20	P(114) A
14	1498.292 44(13)*	1634.90	0.130E-20	P(122) A	39	1502.116 53(10)*	1379.22	0.416E-20	P(112) A
15	1498.429 43(15)*	706.67	0.860E-21	R(80) a	40	1502.860 7	1133.21	0.542E-21	P(103) M
16	1498.628 7	1770.61	0.448E-21	P(81) H	41	1502.864 63(10)*	1330.68	0.518E-20	P(110) A
17	1498.637 70(15)*	742.19	0.742E-21	R(82) a	42	1503.607 14(10)*	1283.00	0.641E-20	P(108) A
18	1498.840 39(14)*	778.59	0.637E-21	R(84) a	43	1504.337 6	1305.73	0.363E-20	P(68) E
19	1499.037 50(14)*	815.85	0.544E-21	R(86) a	44	1504.344 08(10)*	1236.19	0.790E-20	P(106) A
20	1499.068 40(12)*	1582.03	0.166E-20	P(120) A					
21	1499.229 03(14)*	853.98	0.462E-21	R(88) a					
22	1499.414 96(13)*	892.98	0.391E-21	R(90) a					
23	1499.595 31(13)*	932.85	0.329E-21	R(92) a					
24	1499.600 8	1718.81	0.555E-21	P(78) I					
25	1499.770 06(13)*	973.59	0.276E-21	R(94) a					

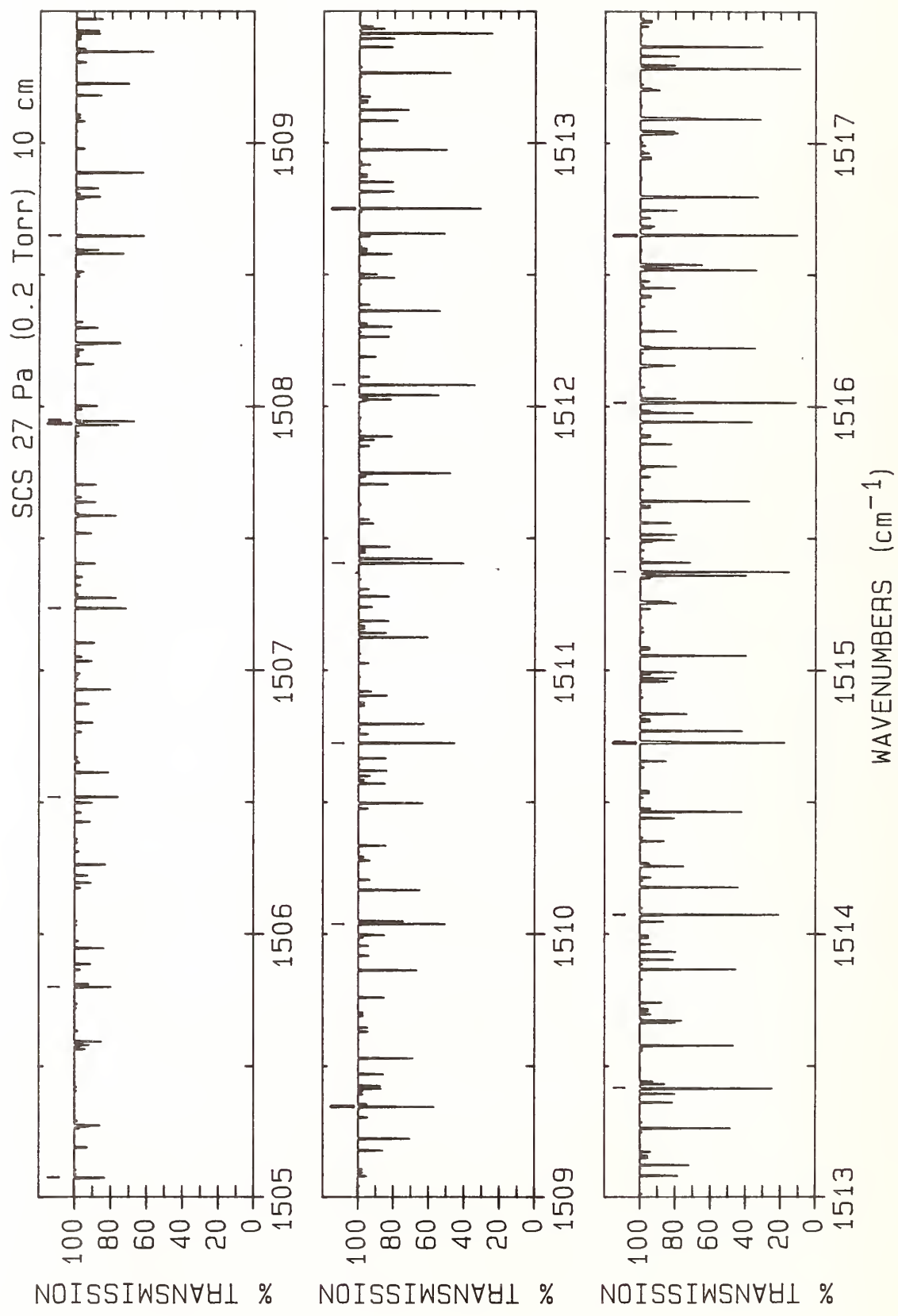

LINE #	WAVENUMBER(unc) (cm^{-1})	LOWER STATE (cm^{-1})	INTENSITY ($\text{cm}/\text{molecule}$)	ASSIGNMENT ROTATION BAND	LINE #	WAVENUMBER(unc) (cm^{-1})	LOWER STATE (cm^{-1})	INTENSITY ($\text{cm}/\text{molecule}$)	ASSIGNMENT ROTATION BAND
1	1505.075 43(10)*	1190.25	0.970E-20	P(104) A	16	1513.415 32(10)*	706.64	0.787E-19	P(80) A
2	1505.801 20(10)*	1145.18	0.119E-19	P(102) A	17	1514.071 2	692.58	0.426E-21	P(52) R
3	1506.521 38(10)*	1100.97	0.144E-19	P(100) A	18	1514.073 89(10)*	671.99	0.909E-19	P(78) A
4	1507.235 96(10)*	1057.63	0.174E-19	P(98) A	19	1514.726 83(10)*	638.20	0.104E-18	P(76) A
5	1507.936 5	1335.45	0.235E-20	P(51) H	20	1514.727 1	1122.70	0.339E-20	P(26) I
6	1507.944 96(10)*	1015.16	0.210E-19	P(96) A	21	1514.731 1	907.67	0.119E-19	P(32) E
7	1507.950 5	918.67	0.250E-21	P(92) Q	22	1515.374 16(10)*	605.29	0.119E-18	P(74) A
8	1508.648 36(10)*	973.56	0.252E-19	P(94) A	23	1516.013 8	890.90	0.113E-19	P(28) G
9	1508.650 9	791.78	0.239E-20	P(86) M	24	1516.015 88(10)*	573.24	0.136E-18	P(72) A
10	1509.346 16(11)*	932.82	0.301E-19	P(92) A	25	1516.651 97(10)*	542.07	0.154E-18	P(70) A
11	1510.038 37(11)*	892.95	0.357E-19	P(90) A					
12	1510.724 97(11)*	853.95	0.422E-19	P(88) A					
13	1511.405 97(11)*	815.82	0.497E-19	P(86) A					
14	1512.081 36(11)*	778.56	0.582E-19	P(84) A					
15	1512.751 15(11)*	742.17	0.679E-19	P(82) A					

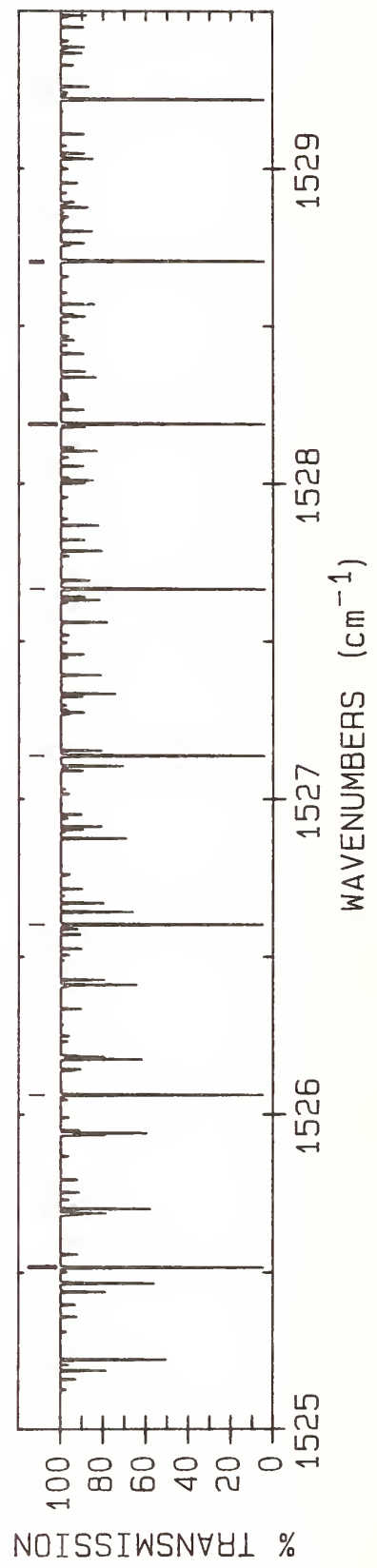
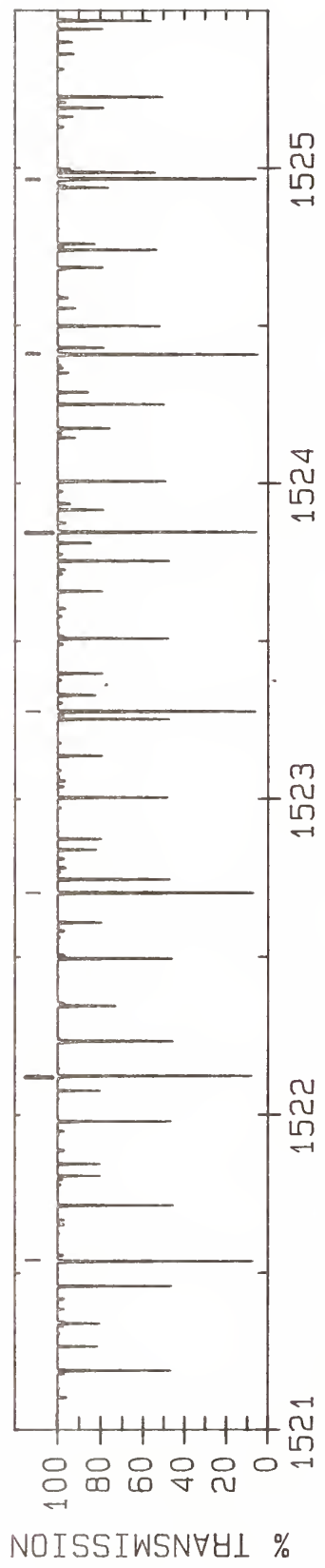
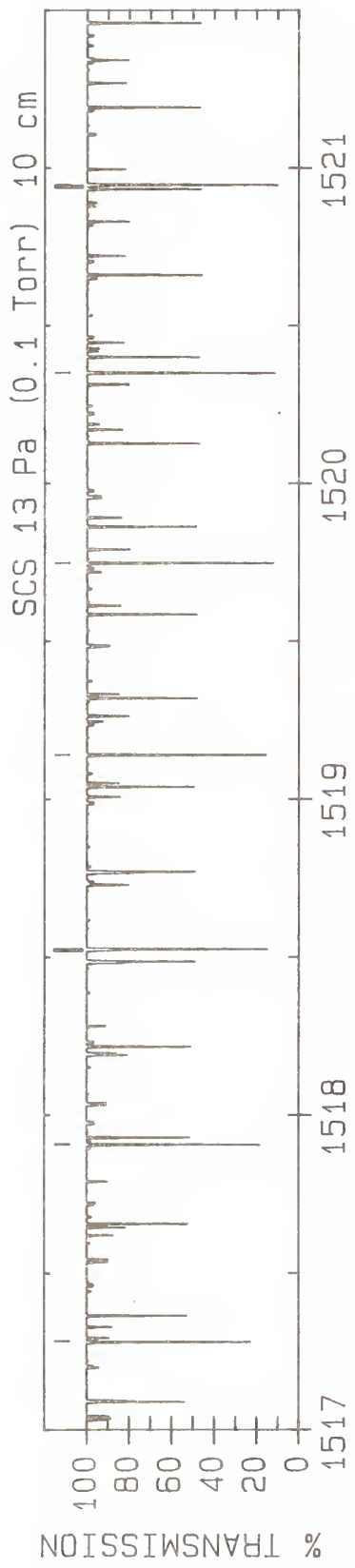

LINE #	WAVENUMBER(unc) (cm ⁻¹)	LOWER STATE (cm ⁻¹)	INTENSITY (cm/molecule)	ASSIGNMENT ROTATION BAND	LINE #	WAVENUMBER(unc) (cm ⁻¹)	LOWER STATE (cm ⁻¹)	INTENSITY (cm/molecule)	ASSIGNMENT ROTATION BAND
1	1517.282 43(10)*	511.76	0.173E-18	P(68) A	21	1524.408 57(8)*	216.02	0.473E-18	P(44) A
2	1517.907 27(10)*	482.33	0.194E-18	P(66) A	22	1524.412 7	159.24	0.418E-20	P(38) Q
3	1517.909 3	337.94	0.142E-19	P(56) M	23	1524.961 2	806.46	0.730E-20	R(11) F
4	1518.522 8	839.45	0.935E-20	P(18) G	24	1524.965 72(8)*	197.04	0.496E-18	P(42) A
5	1518.525 5	825.52	0.942E-20	P(17) F	25	1525.517 22(8)*	178.94	0.516E-18	P(40) A
6	1518.526 48(9)*	453.76	0.216E-18	P(64) A	26	1526.063 07(8)*	161.70	0.533E-18	P(38) A
7	1519.140 07(9)*	426.07	0.240E-18	P(62) A	27	1526.603 25(8)*	145.34	0.547E-18	P(36) A
8	1519.748 01(9)*	399.24	0.264E-18	P(60) A	28	1527.137 77(8)*	129.84	0.557E-18	P(34) A
9	1520.350 33(9)*	373.29	0.290E-18	P(58) A	29	1527.666 63(8)*	115.22	0.563E-18	P(32) A
10	1520.942 4	440.58	0.309E-20	P(20) O	30	1528.189 82(8)*	101.48	0.565E-18	P(30) A
11	1520.945 4	440.55	0.309E-20	P(20) N	31	1528.701 0	429.44	0.438E-21	Q(17) B
12	1520.947 01(9)*	348.21	0.316E-18	P(56) A	32	1528.705 1	900.66	0.124E-19	R(31) F
13	1521.538 04(9)*	324.00	0.343E-18	P(54) A	33	1528.707 34(9)*	88.60	0.561E-18	P(28) A
14	1521.539 4	200.34	0.213E-19	P(43) M					
15	1522.120 8	421.48	0.254E-20	P(15) O					
16	1522.123 0	421.46	0.254E-20	P(15) N					
17	1522.123 44(9)*	300.66	0.370E-18	P(52) A					
18	1522.703 19(9)*	278.19	0.397E-18	P(50) A					
19	1523.277 30(8)*	256.60	0.424E-18	P(48) A					
20	1523.845 76(8)*	235.88	0.449E-18	P(46) A					

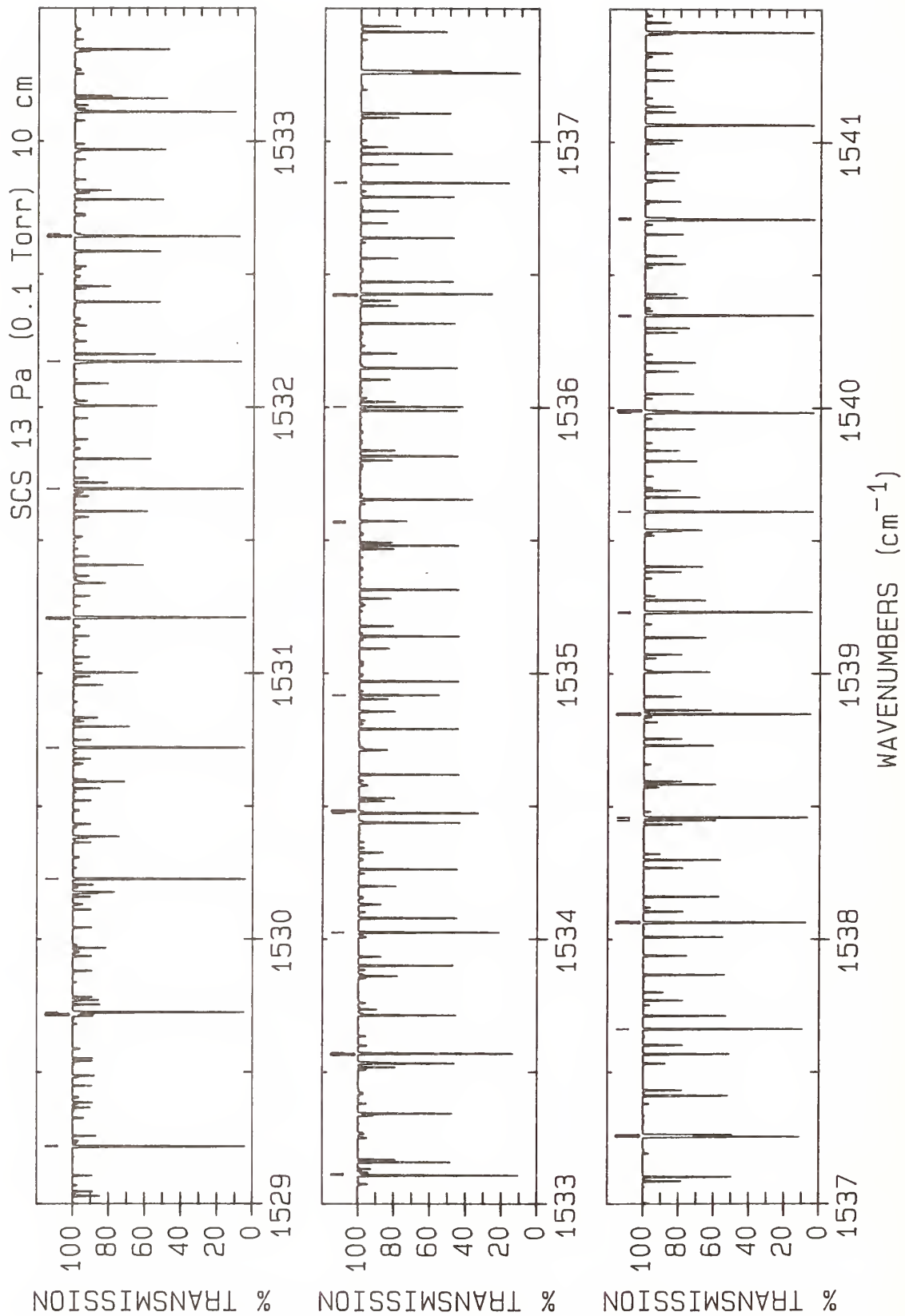

LINE #	WAVENUMBER(cm^{-1})	LOWER STATE (cm^{-1})	INTENSITY ($\text{cm}/\text{molecule}$)	ASSIGNMENT ROTATION BAND	LINE #	WAVENUMBER(unc) (cm^{-1})	LOWER STATE (cm^{-1})	INTENSITY ($\text{cm}/\text{molecule}$)	ASSIGNMENT ROTATION BAND
1	1529.217 7	922.35	0.122E-19	R(34) E	31	1536.426 10(10)*	2.18	0.153E-18	R(4) A
2	1529.219 0	432.28	0.307E-20	R(18) N	32	1536.426 2	19.56	0.306E-20	R(13) Q
3	1529.219 20(9)*	76.60	0.553E-18	P(26) A	33	1536.844 06(10)*	4.58	0.212E-18	R(6) A
4	1529.221 4	432.30	0.307E-20	R(18) O	34	1536.845 8	1790.09	0.497E-21	R(95) F
5	1529.717 3	946.00	0.118E-19	R(37) F	35	1537.256 31(10)*	7.86	0.269E-18	R(8) A
6	1529.719 9	32.88	0.347E-20	P(17) Q	36	1537.258 7	981.54	0.144E-19	R(54) D
7	1529.725 38(9)*	65.47	0.539E-18	P(24) A	37	1537.261 0	80.06	0.252E-19	R(27) M
8	1530.225 88(9)*	55.22	0.519E-18	P(22) A	38	1537.263 8	612.52	0.712E-19	R(44) C
9	1530.720 71(9)*	45.83	0.494E-18	P(20) A	39	1537.662 85(10)*	12.00	0.322E-18	R(10) A
10	1531.207 2	408.03	0.465E-19	R(10) C	40	1538.063 68(10)*	17.02	0.371E-18	R(12) A
11	1531.209 86(9)*	37.32	0.464E-18	P(18) A	41	1538.064 5	1056.67	0.111E-19	R(60) D
12	1531.693 32(9)*	29.68	0.428E-18	P(16) A	42	1538.448 4	697.36	0.556E-19	R(52) C
13	1532.171 10(9)*	22.92	0.387E-18	P(14) A	43	1538.458 5	886.18	0.221E-21	R(67) R
14	1532.172 7	529.73	0.363E-20	R(35) O	44	1538.458 79(10)*	22.92	0.416E-18	R(14) A
15	1532.643 20(9)*	17.02	0.342E-18	P(12) A	45	1538.848 18(10)*	29.68	0.457E-18	R(16) A
16	1532.647 4	553.18	0.351E-20	R(38) N	46	1539.228 4	165.19	0.238E-19	R(39) M
17	1532.651 9	553.29	0.351E-20	R(38) O	47	1539.231 84(10)*	37.32	0.492E-18	R(18) A
18	1533.109 61(9)*	12.00	0.292E-18	P(10) A	48	1539.609 79(10)*	45.83	0.522E-18	R(20) A
19	1533.113 9	578.64	0.334E-20	R(41) N	49	1539.982 00(10)*	55.22	0.546E-18	R(22) A
20	1533.567 8	605.99	0.314E-20	R(44) N	50	1539.989 0	209.65	0.216E-19	R(44) M
21	1533.570 32(9)*	7.86	0.238E-18	P(8) A	51	1540.345 2	632.55	0.208E-21	R(78) V
22	1533.572 9	606.13	0.314E-20	R(44) O	52	1540.348 49(10)*	65.47	0.565E-18	R(24) A
23	1534.025 34(9)*	4.58	0.182E-18	P(6) A	53	1540.709 25(10)*	76.60	0.578E-18	R(26) A
24	1534.474 67(10)*	2.18	0.122E-18	P(4) A	54	1540.714 8	259.41	0.189E-19	R(49) M
25	1534.481 7	1351.71	0.314E-20	R(71) F					
26	1534.918 30(10)*	0.66	0.617E-19	P(2) A					
27	1535.567 5	1519.10	0.158E-20	R(81) F					
28	1535.573 06(10)*	0.00	0.310E-19	R(0) A					
29	1536.002 43(10)*	0.66	0.926E-19	R(2) A					
30	1536.422 0	1688.37	0.772E-21	R(90) E					

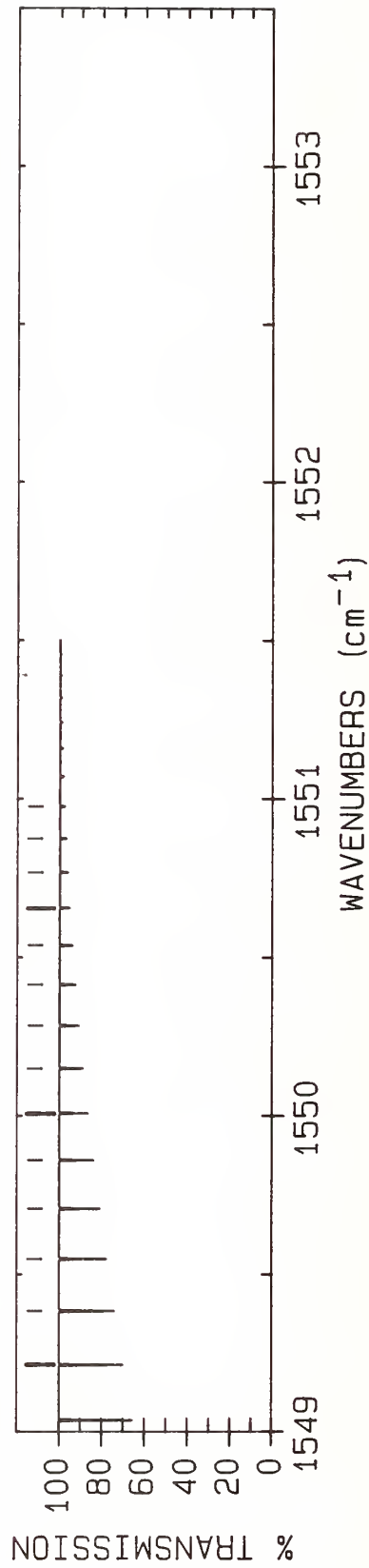
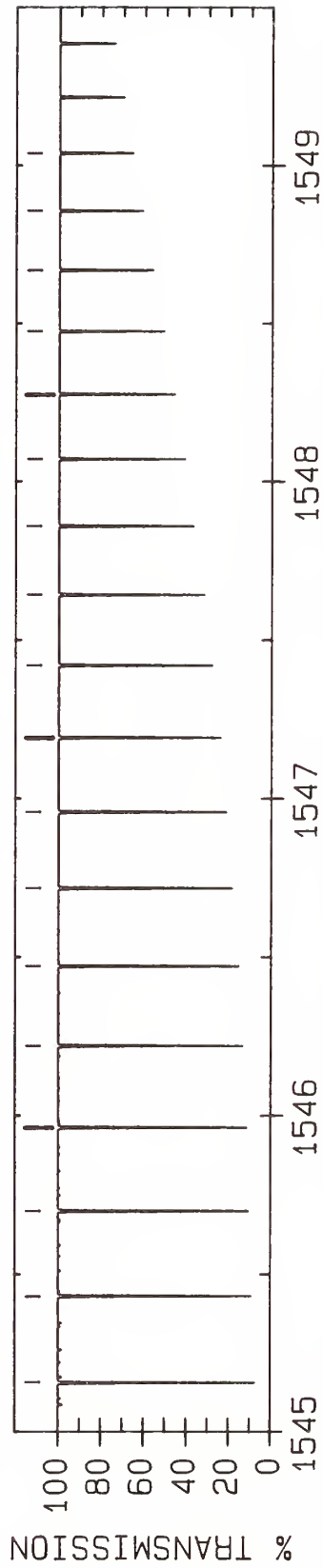
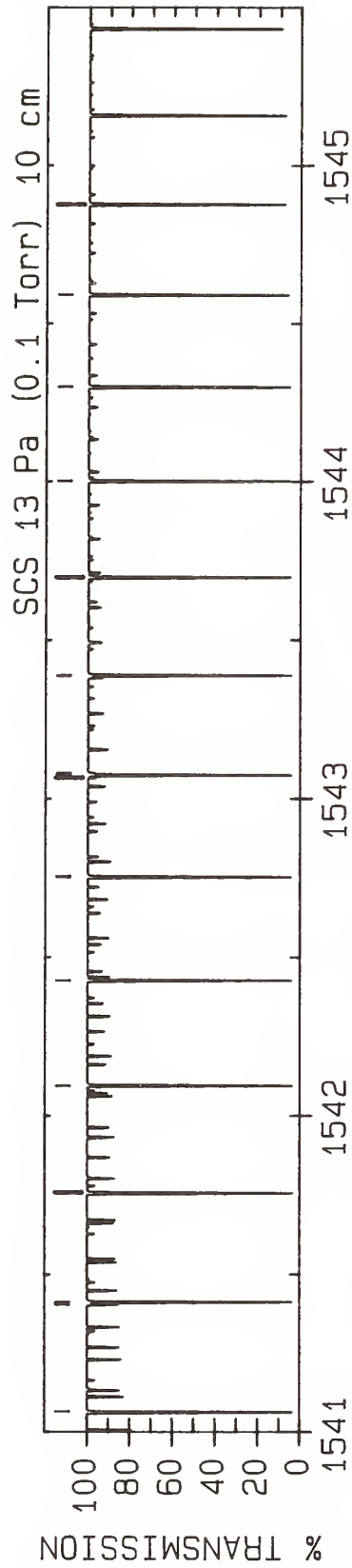

LINE #	WAVENUMBER(unc) (cm ⁻¹)	LOWER STATE (cm ⁻¹)	INTENSITY (cm/molecule)	ASSIGNMENT ROTATION BAND	LINE #	WAVENUMBER(unc) (cm ⁻¹)	LOWER STATE (cm ⁻¹)	INTENSITY (cm/molecule)	ASSIGNMENT ROTATION BAND
1	1541.064 28(10)*	88.60	0.586E-18	R(28) A	31	1547.419 87(17)*	573.24	0.140E-18	R(72) A
2	1541.405 6	314.45	0.159E-19	R(54) M	32	1547.642 42(17)*	605.29	0.124E-18	R(74) A
3	1541.413 57(10)*	101.48	0.589E-18	R(30) A	33	1547.859 17(18)*	638.20	0.108E-18	R(76) A
4	1541.757 12(10)*	115.22	0.586E-18	R(32) A	34	1548.070 14(18)*	671.99	0.941E-19	R(78) A
5	1541.759 5	1086.30	0.127E-19	R(79) B	35	1548.275 32(19)*	706.64	0.815E-19	R(80) A
6	1542.094 94(11)*	129.84	0.579E-18	R(34) A	36	1548.474 70(19)*	742.17	0.703E-19	R(82) A
7	1542.427 01(11)*	145.34	0.568E-18	R(36) A	37	1548.668 28(20)*	778.56	0.603E-19	R(84) A
8	1542.753 34(11)*	161.70	0.553E-18	R(38) A	38	1548.856 07(20)*	815.82	0.515E-19	R(86) A
9	1542.755 8	1986.75	0.221E-21	R(110) D	39	1549.038 05(20)*	853.95	0.438E-19	R(88) A
10	1543.065 8	1350.59	0.413E-20	R(93) B	40	1549.214 23(21)*	892.95	0.371E-19	R(90) A
11	1543.073 92(11)*	178.94	0.535E-18	R(40) A	41	1549.384 61(21)*	932.82	0.312E-19	R(92) A
12	1543.079 9	307.48	0.293E-20	R(53) Q	42	1549.549 18(21)*	973.56	0.262E-19	R(94) A
13	1543.387 0	1433.93	0.287E-20	R(97) B	43	1549.707 93(22)*	1015.16	0.218E-19	R(96) A
14	1543.388 76(11)*	197.04	0.514E-18	R(42) A	44	1549.860 88(22)*	1057.63	0.181E-19	R(98) A
15	1543.697 84(11)*	216.02	0.490E-18	R(44) A	45	1550.008 01(22)*	1100.97	0.150E-19	R(100) A
16	1544.001 17(12)*	235.88	0.465E-18	R(46) A	46	1550.149 32(23)*	1145.18	0.123E-19	R(102) A
17	1544.298 74(12)*	256.60	0.439E-18	R(48) A	47	1550.284 81(23)*	1190.25	0.101E-19	R(104) A
18	1544.590 56(12)*	278.19	0.411E-18	R(50) A	48	1550.414 48(23)*	1236.19	0.822E-20	R(106) A
19	1544.873 4	489.39	0.152E-20	R(67) Q	49	1550.538 33(23)*	1283.00	0.667E-20	R(108) A
20	1544.876 61(13)*	300.66	0.383E-18	R(52) A	50	1550.656 35(24)	1330.68	0.539E-20	R(110) A
21	1545.156 91(13)*	324.00	0.355E-18	R(54) A	51	1550.768 54(25)	1379.22	0.433E-20	R(112) A
22	1545.429 7	885.88	0.166E-20	R(91) M	52	1550.874 90(26)	1428.62	0.347E-20	R(114) A
23	1545.431 44(13)*	348.21	0.327E-18	R(56) A	53	1550.975 43(28)	1478.89	0.276E-20	R(116) A
24	1545.700 20(14)*	373.29	0.300E-18	R(58) A					
25	1545.963 19(14)*	399.24	0.273E-18	R(60) A					
26	1546.220 41(15)*	426.07	0.248E-18	R(62) A					
27	1546.471 86(15)*	453.76	0.223E-18	R(64) A					
28	1546.717 53(16)*	482.33	0.201E-18	R(66) A					
29	1546.957 43(16)*	511.76	0.179E-18	R(68) A					
30	1547.191 54(16)*	542.07	0.159E-18	R(70) A					

ATLAS OF NO ABSORPTION LINES FROM 1741 cm^{-1} to 1940 cm^{-1}

key:

Band	Isotopomer	Transition
A	$^{14}\text{N}^{16}\text{O}$	$^2\Pi_{1/2} - ^2\Pi_{1/2}(\text{e})$
B	$^{14}\text{N}^{16}\text{O}$	$^2\Pi_{1/2} - ^2\Pi_{1/2}(\text{f})$
C	$^{14}\text{N}^{16}\text{O}$	$^2\Pi_{3/2} - ^2\Pi_{3/2}(\text{e})$
D	$^{14}\text{N}^{16}\text{O}$	$^2\Pi_{3/2} - ^2\Pi_{3/2}(\text{f})$

The e or f designation only refers to the lower level. The transition is to the appropriate upper level, depending on the selection rules and the change in the rotational quantum number. Spectra are given for a slitwidth of 0.003 cm^{-1} and a transition moment of 0.00412 debye at a temperature of 296 K .

NO 1 m, 270 Pa (2 Torr)

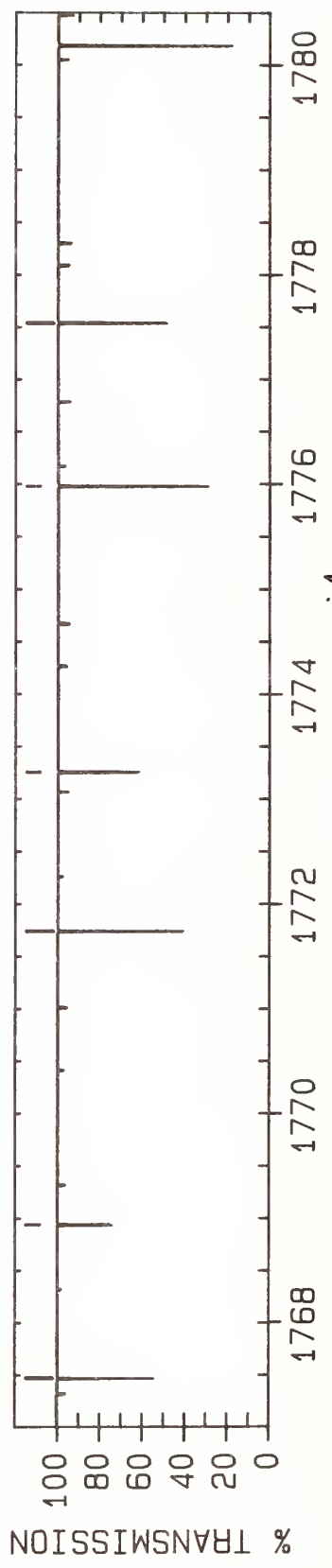
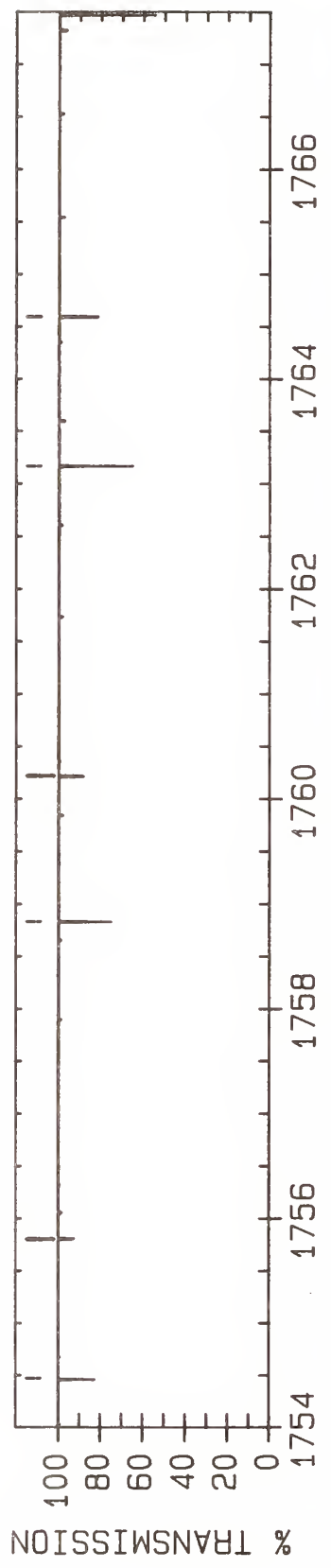
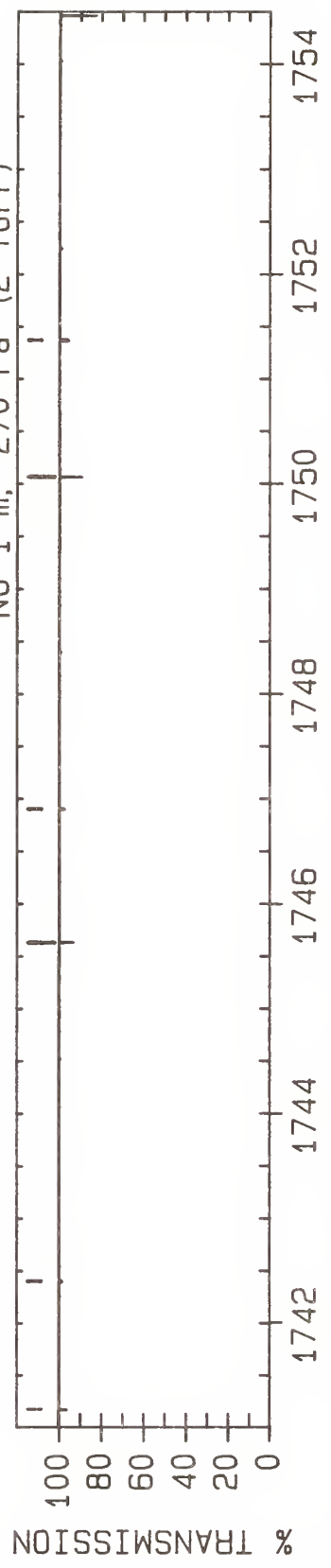

LINE #	WAVENUMBER(unc) (cm ⁻¹)	LOWER STATE (cm ⁻¹)	INTENSITY (cm/molecule)	ASSIGNMENT ROTATION BAND	LINE #	WAVENUMBER(unc) (cm ⁻¹)	LOWER STATE (cm ⁻¹)	INTENSITY (cm/molecule)	ASSIGNMENT ROTATION BAND
1	1741.172 11(50)	2043.78	0.204E-22	P(34.5) B	21	1763.166 14(34)*	1501.94	0.247E-21	P(29.5) B
2	1741.172 98(50)	2043.50	0.205E-22	P(34.5) A	22	1763.169 13(34)*	1501.68	0.247E-21	P(29.5) A
3	1742.398 24(→)	2094.53	0.155E-22	P(33.5) D	23	1764.590 20(50)*	1558.15	0.181E-21	P(28.5) D
4	1742.409 38(→)	2094.40	0.155E-22	P(33.5) C	24	1764.599 10(50)*	1558.06	0.181E-21	P(28.5) C
5	1745.634 54(45)	1928.80	0.348E-22	P(33.5) B	25	1767.468 82(32)*	1403.50	0.385E-21	P(28.5) B
6	1745.635 84(45)	1928.53	0.348E-22	P(33.5) A	26	1767.472 24(32)*	1403.24	0.386E-21	P(28.5) A
7	1746.897 49(90)	1980.57	0.262E-22	P(32.5) D	27	1768.936 78(45)*	1460.92	0.281E-21	P(27.5) D
8	1746.908 19(90)	1980.45	0.262E-22	P(32.5) C	28	1768.945 25(45)*	1460.84	0.281E-21	P(27.5) C
9	1750.065 30(40)*	1817.13	0.582E-22	P(32.5) B	29	1771.739 14(31)*	1308.37	0.592E-21	P(27.5) B
10	1750.067 01(40)*	1816.86	0.583E-22	P(32.5) A	30	1771.743 00(31)*	1308.12	0.592E-21	P(27.5) A
11	1751.366 41(80)	1869.94	0.436E-22	P(31.5) D	31	1773.252 51(40)*	1367.06	0.428E-21	P(26.5) D
12	1751.376 66(80)	1869.83	0.436E-22	P(31.5) C	32	1773.260 54(40)*	1366.99	0.428E-21	P(26.5) C
13	1754.464 23(38)*	1708.75	0.958E-22	P(31.5) B	33	1775.976 97(30)*	1216.57	0.893E-21	P(26.5) B
14	1754.466 38(38)*	1708.49	0.960E-22	P(31.5) A	34	1775.981 26(30)*	1216.32	0.894E-21	P(26.5) A
15	1755.804 91(70)	1762.66	0.713E-22	P(30.5) D	35	1777.537 30(38)*	1276.57	0.640E-21	P(25.5) D
16	1755.814 71(70)	1762.56	0.713E-22	P(30.5) C	36	1777.544 88(38)*	1276.50	0.641E-21	P(25.5) C
17	1758.831 23(36)*	1603.69	0.155E-21	P(30.5) B					
18	1758.833 80(36)*	1603.43	0.155E-21	P(30.5) A					
19	1760.212 87(60)	1658.73	0.115E-21	P(29.5) D					
20	1760.222 22(60)	1658.63	0.115E-21	P(29.5) C					

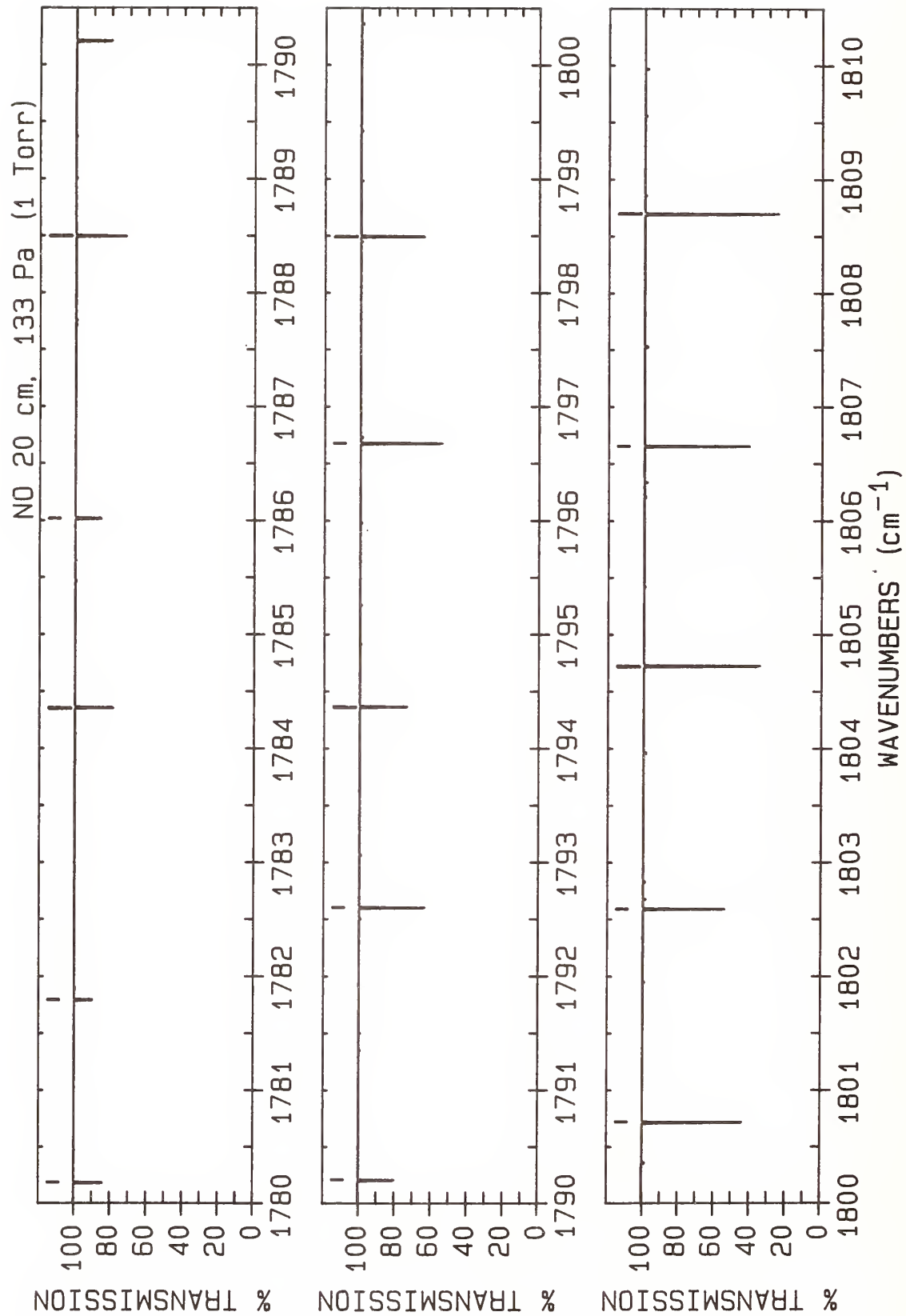

LINE #	WAVENUMBER(unc) (cm ⁻¹)	LOWER STATE (cm ⁻¹)	INTENSITY (cm/molecule)	ASSIGNMENT ROTATION BAND	LINE #	WAVENUMBER(unc) (cm ⁻¹)	LOWER STATE (cm ⁻¹)	INTENSITY (cm/molecule)	ASSIGNMENT ROTATION BAND
1	1780.182 17(30)*	1128.09	0.132E-20	P(25.5) B	16	1794.370 34(30)*	948.30	0.268E-20	P(21.5) C
2	1780.186 89(30)*	1127.84	0.133E-20	P(25.5) A	17	1796.674 17(30)*	807.41	0.535E-20	P(21.5) B
3	1781.791 00(36)*	1189.44	0.942E-21	P(24.5) D	18	1796.680 59(30)*	807.20	0.536E-20	P(21.5) A
4	1781.798 14(36)*	1189.38	0.942E-21	P(24.5) C	19	1798.492 74(29)*	874.75	0.367E-20	P(20.5) D
5	1784.354 62(30)*	1042.93	0.193E-20	P(24.5) B	20	1798.498 12(29)*	874.72	0.367E-20	P(20.5) C
6	1784.359 76(30)*	1042.69	0.193E-20	P(24.5) A	21	1800.714 37(29)*	735.57	0.725E-20	P(20.5) B
7	1786.013 53(34)*	1105.70	0.136E-20	P(23.5) D	22	1800.721 20(29)*	735.36	0.726E-20	P(20.5) A
8	1786.020 22(34)*	1105.64	0.136E-20	P(23.5) C	23	1802.589 26(29)*	804.55	0.491E-20	P(19.5) D
9	1788.494 18(30)*	961.09	0.276E-20	P(23.5) B	24	1802.594 21(29)*	804.52	0.491E-20	P(19.5) C
10	1788.499 76(30)*	960.86	0.276E-20	P(23.5) A	25	1804.721 21(29)*	667.06	0.965E-20	P(19.5) B
11	1790.204 74(32)*	1025.33	0.193E-20	P(22.5) D	26	1804.728 45(29)*	666.86	0.966E-20	P(19.5) A
12	1790.210 99(32)*	1025.28	0.193E-20	P(22.5) C	27	1806.653 93(28)*	737.75	0.646E-20	P(18.5) D
13	1792.600 74(30)*	882.59	0.388E-20	P(22.5) B	28	1806.658 47(28)*	737.72	0.646E-20	P(18.5) C
14	1792.606 74(30)*	882.36	0.388E-20	P(22.5) A	29	1808.694 60(28)*	601.89	0.126E-19	P(18.5) B
15	1794.364 52(30)*	948.35	0.268E-20	P(21.5) D	30	1808.702 23(28)*	601.69	0.126E-19	P(18.5) A

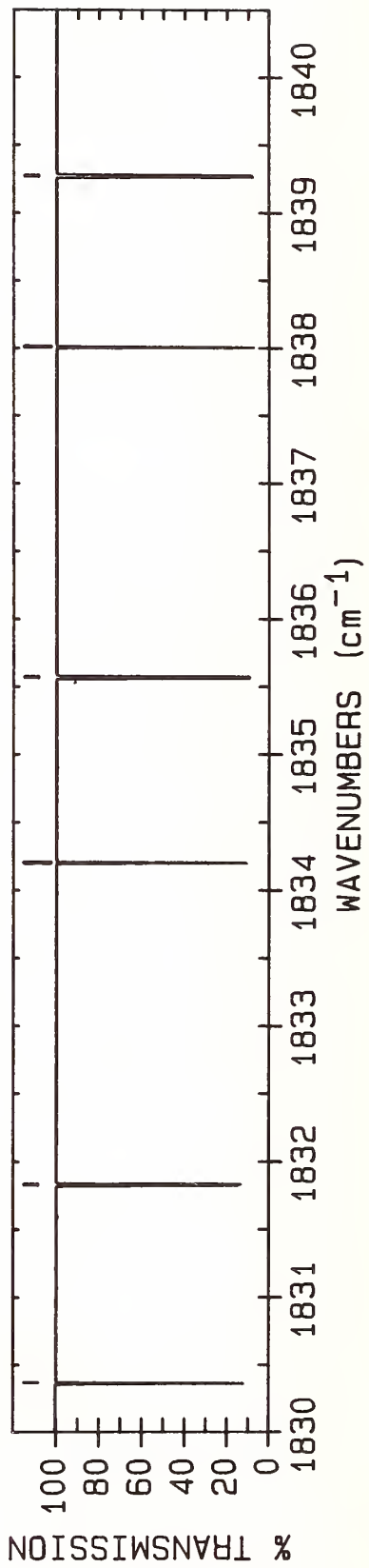
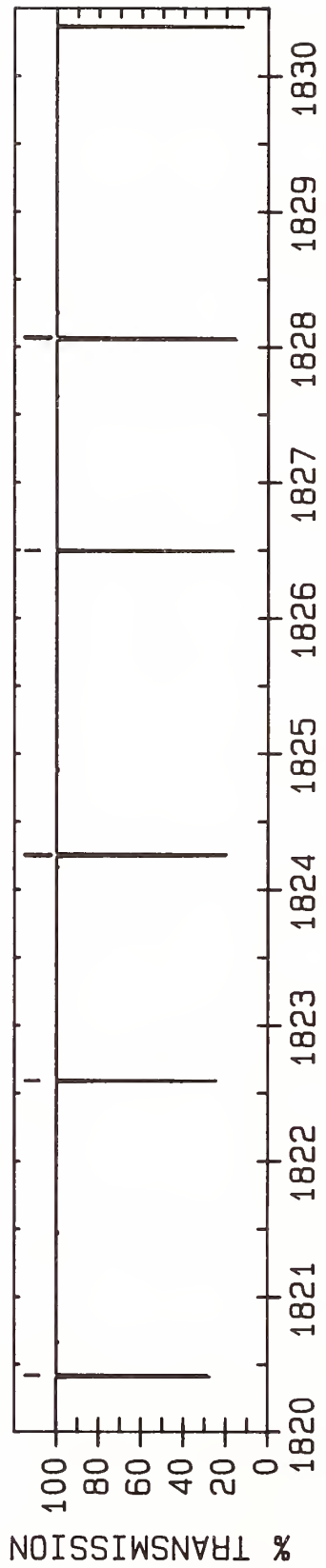
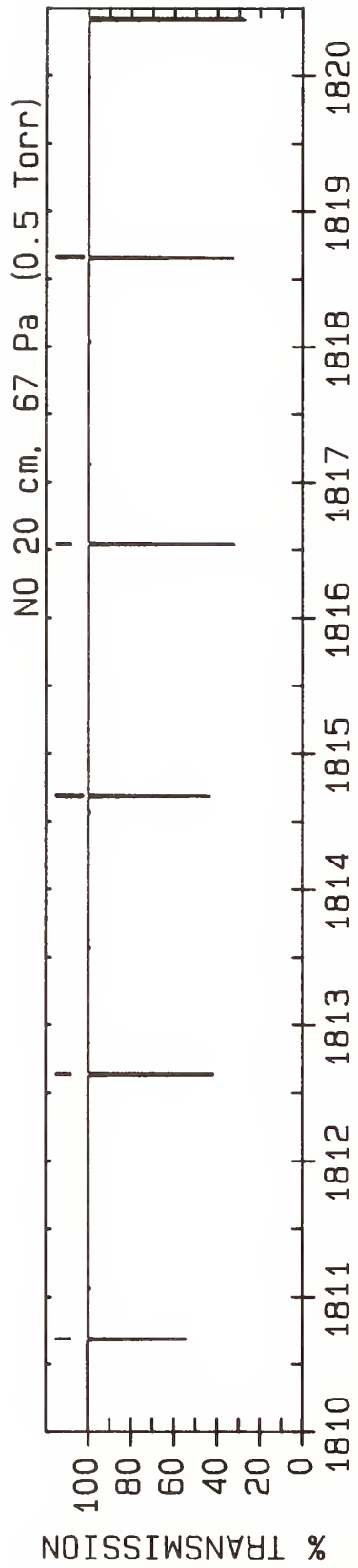

LINE #	WAVENUMBER(unc) (cm ⁻¹)	LOWER STATE (cm ⁻¹)	INTENSITY (cm/molecule)	ASSIGNMENT ROTATION BAND	LINE #	WAVENUMBER(unc) (cm ⁻¹)	LOWER STATE (cm ⁻¹)	INTENSITY (cm/molecule)	ASSIGNMENT ROTATION BAND
1	1810.686 61(28)*	674.35	0.833E-20	P(17.5) D	21	1830.364 44(26)*	408.46	0.217E-19	P(12.5) D
2	1810.690 74(28)*	674.32	0.833E-20	P(17.5) C	22	1830.366 70(26)*	408.45	0.217E-19	P(12.5) C
3	1812.634 42(28)*	540.05	0.161E-19	P(17.5) B	23	1831.827 16(26)*	280.95	0.410E-19	P(12.5) B
4	1812.642 44(28)*	539.87	0.161E-19	P(17.5) A	24	1831.836 98(26)*	280.81	0.410E-19	P(12.5) A
5	1814.687 15(27)*	614.35	0.105E-19	P(16.5) D	25	1834.201 62(25)*	365.54	0.246E-19	P(11.5) D
6	1814.690 88(27)*	614.33	0.105E-19	P(16.5) C	26	1834.203 55(25)*	365.53	0.246E-19	P(11.5) C
7	1816.540 59(27)*	481.55	0.202E-19	P(16.5) B	27	1835.563 93(25)*	239.15	0.463E-19	P(11.5) B
8	1816.549 00(27)*	481.37	0.203E-19	P(16.5) A	28	1835.574 06(25)*	239.02	0.463E-19	P(11.5) A
9	1818.655 38(27)*	557.76	0.130E-19	P(15.5) D	29	1838.005 55(25)*	326.03	0.272E-19	P(10.5) D
10	1818.658 72(27)*	557.74	0.130E-19	P(15.5) C	30	1838.007 17(25)*	326.03	0.272E-19	P(10.5) C
11	1820.413 02(27)*	426.39	0.249E-19	P(15.5) B	31	1839.266 66(25)*	200.70	0.510E-19	P(10.5) B
12	1820.421 81(27)*	426.22	0.249E-19	P(15.5) A	32	1839.277 07(25)*	200.57	0.510E-19	P(10.5) A
13	1822.591 13(26)*	504.58	0.158E-19	P(14.5) D					
14	1822.594 09(26)*	504.56	0.158E-19	P(14.5) C					
15	1824.251 64(26)*	374.57	0.300E-19	P(14.5) B					
16	1824.260 79(26)*	374.41	0.301E-19	P(14.5) A					
17	1826.494 21(26)*	454.81	0.187E-19	P(13.5) D					
18	1826.496 81(26)*	454.80	0.188E-19	P(13.5) C					
19	1828.056 38(26)*	326.09	0.355E-19	P(13.5) B					
20	1828.065 86(26)*	325.94	0.355E-19	P(13.5) A					

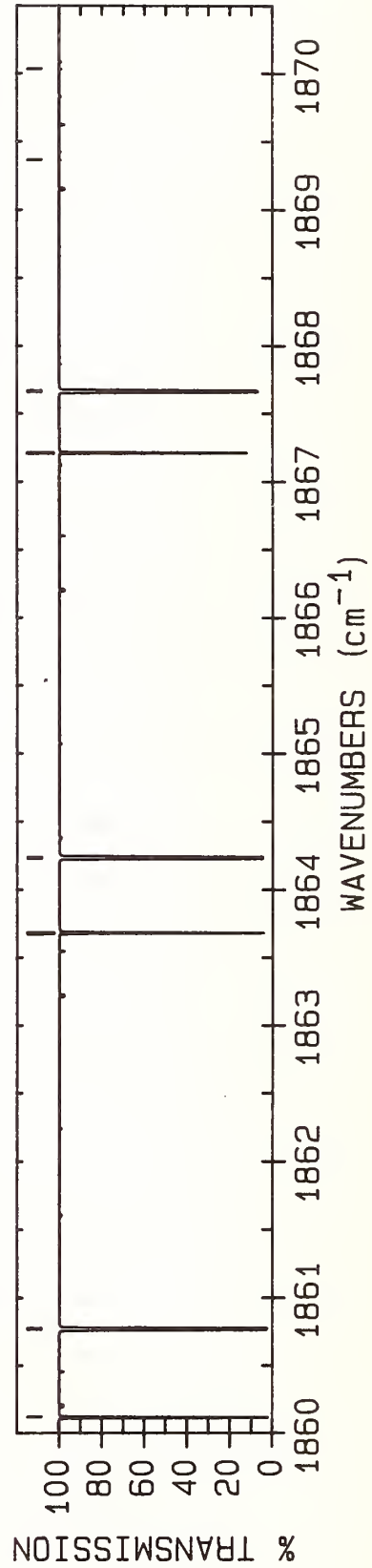
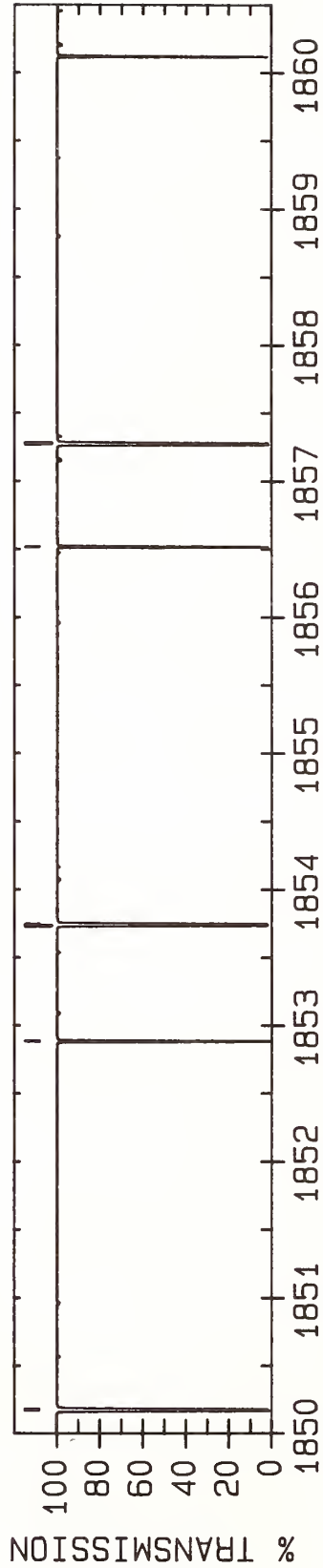
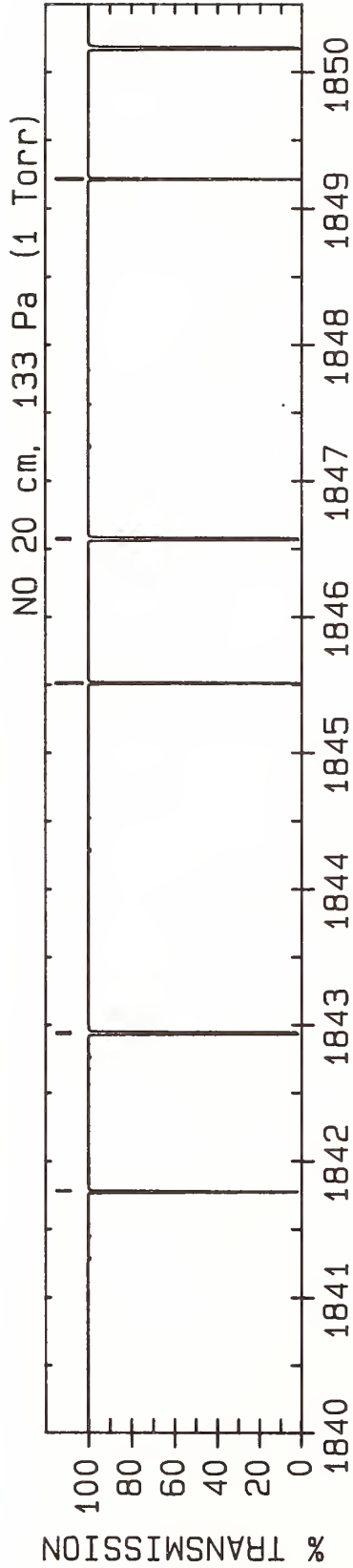

LINE #	WAVENUMBER(unc) (cm ⁻¹)	LOWER STATE (cm ⁻¹)	INTENSITY (cm/molecule)	ASSIGNMENT ROTATION BAND	LINE #	WAVENUMBER(unc) (cm ⁻¹)	LOWER STATE (cm ⁻¹)	INTENSITY (cm/molecule)	ASSIGNMENT ROTATION BAND
1	1841.776 00(25)*	289.96	0.293E-19	P(9.5) D	21	1860.118 08(22)*	161.03	0.239E-19	P(4.5) D
2	1841.777 33(25)*	289.95	0.293E-19	P(9.5) C	22	1860.118 38(22)*	161.03	0.239E-19	P(4.5) C
3	1842.935 28(25)*	165.58	0.548E-19	P(9.5) B	23	1860.766 19(22)*	40.16	0.478E-19	P(4.5) B
4	1842.945 97(25)*	165.47	0.549E-19	P(9.5) A	24	1860.777 83(22)*	40.10	0.478E-19	P(4.5) A
5	1845.512 75(24)*	257.31	0.306E-19	P(8.5) D	25	1863.682 75(22)*	145.55	0.184E-19	P(3.5) D
6	1845.513 83(24)*	257.30	0.306E-19	P(8.5) C	26	1863.682 93(22)*	145.55	0.184E-19	P(3.5) C
7	1846.569 80(24)*	133.81	0.573E-19	P(8.5) B	27	1864.229 83(22)*	25.11	0.397E-19	P(3.5) B
8	1846.580 72(24)*	133.71	0.573E-19	P(8.5) A	28	1864.241 57(22)*	25.06	0.397E-19	P(3.5) A
9	1849.215 58(24)*	228.09	0.309E-19	P(7.5) D	29	1867.212 25(21)*	133.51	0.110E-19	P(2.5) D
10	1849.216 43(24)*	228.08	0.309E-19	P(7.5) C	30	1867.212 34(21)*	133.51	0.110E-19	P(2.5) C
11	1850.170 15(24)*	105.38	0.581E-19	P(7.5) B	31	1867.659 26(21)*	13.40	0.295E-19	P(2.5) B
12	1850.181 30(24)*	105.29	0.582E-19	P(7.5) A	32	1867.671 08(21)*	13.36	0.295E-19	P(2.5) A
13	1852.884 24(23)*	202.30	0.300E-19	P(6.5) D	33	1869.364 08(28)*	737.75	0.862E-22	Q(18.5) D
14	1852.884 88(23)*	202.30	0.300E-19	P(6.5) C	34	1870.032 16(28)*	674.35	0.124E-21	Q(17.5) D
15	1853.736 35(23)*	80.30	0.569E-19	P(6.5) B					
16	1853.747 69(23)*	80.22	0.570E-19	P(6.5) A					
17	1856.518 49(23)*	179.95	0.277E-19	P(5.5) D					
18	1856.518 94(23)*	179.95	0.277E-19	P(5.5) C					
19	1857.268 36(23)*	58.56	0.535E-19	P(5.5) B					
20	1857.279 86(23)*	58.49	0.535E-19	P(5.5) A					

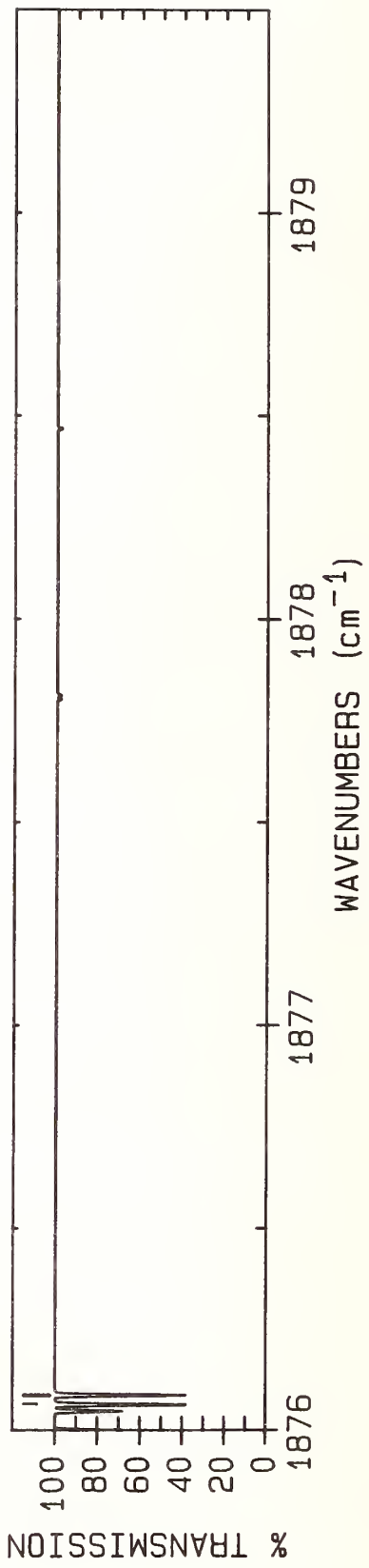
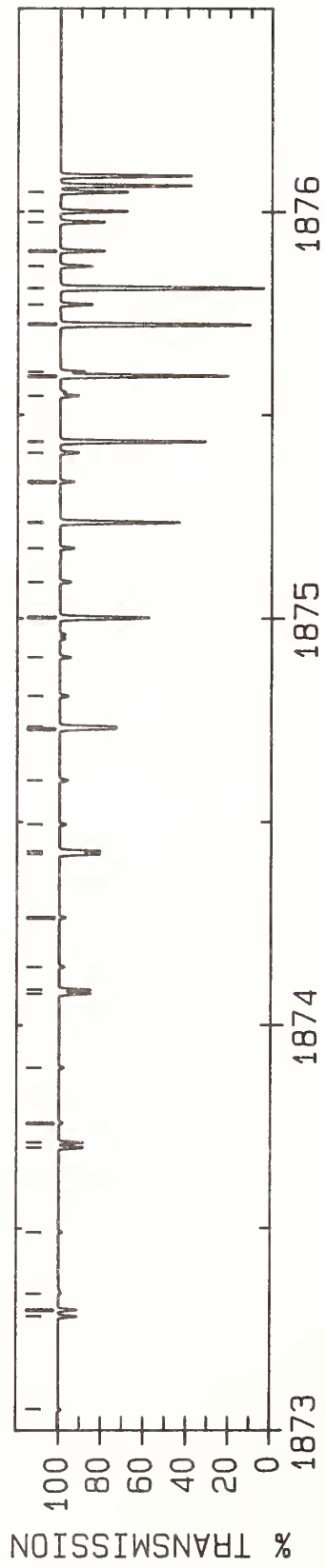
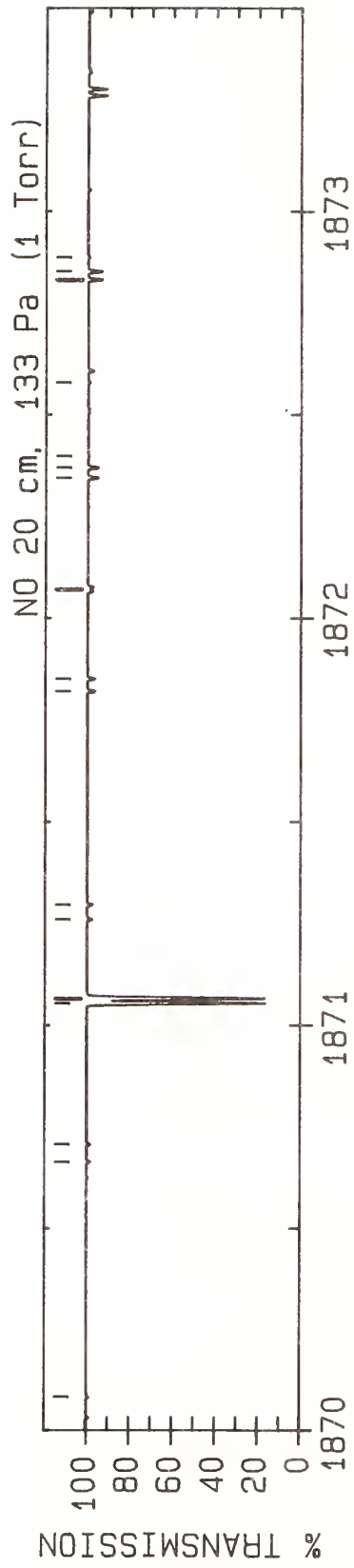

LINE #	WAVENUMBER(unc) (cm ⁻¹)	LOWER STATE (cm ⁻¹)	INTENSITY (cm/molecule)	ASSIGNMENT ROTATION BAND	LINE #	WAVENUMBER(unc) (cm ⁻¹)	LOWER STATE (cm ⁻¹)	INTENSITY (cm/molecule)	ASSIGNMENT ROTATION BAND
1	1870.082 42(28)*	674.32	0.124E-21	Q(17.5) C	36	1874.734 13(24)*	228.08	0.245E-20	Q(7.5) C
2	1870.664 23(27)*	614.35	0.176E-21	Q(16.5) D	37	1874.809 44(24)*	133.71	0.383E-21	Q(8.5) A
3	1870.707 16(27)*	614.33	0.176E-21	Q(16.5) C	38	1874.904 95(24)*	105.38	0.495E-21	Q(7.5) B
4	1871.054 51(21)*	5.03	0.171E-19	P(1.5) B	39	1875.000 23(23)*	202.30	0.318E-20	Q(6.5) D
5	1871.066 37(21)*	5.01	0.171E-19	P(1.5) A	40	1875.003 51(23)*	202.30	0.318E-20	Q(6.5) C
6	1871.260 27(27)*	557.76	0.246E-21	Q(15.5) D	41	1875.089 97(24)*	105.29	0.495E-21	Q(7.5) A
7	1871.296 54(27)*	557.74	0.246E-21	Q(15.5) C	42	1875.173 02(23)*	80.30	0.640E-21	Q(6.5) B
8	1871.820 27(26)*	504.58	0.340E-21	Q(14.5) D	43	1875.235 05(23)*	179.95	0.415E-20	Q(5.5) D
9	1871.850 53(26)*	504.56	0.340E-21	Q(14.5) C	44	1875.237 11(23)*	179.95	0.415E-20	Q(5.5) C
10	1872.071 41(26)*	374.57	0.710E-22	Q(14.5) B	45	1875.335 90(23)*	80.22	0.640E-21	Q(6.5) A
11	1872.344 19(26)*	454.81	0.464E-21	Q(13.5) D	46	1875.406 96(23)*	58.56	0.831E-21	Q(5.5) B
12	1872.369 08(26)*	454.80	0.464E-21	Q(13.5) C	47	1875.433 70(22)*	161.03	0.547E-20	Q(4.5) D
13	1872.397 22(26)*	374.41	0.711E-22	Q(14.5) A	48	1875.434 89(22)*	161.03	0.547E-20	Q(4.5) C
14	1872.578 89(26)*	326.09	0.964E-22	Q(13.5) B	49	1875.547 32(23)*	58.49	0.832E-21	Q(5.5) A
15	1872.832 02(26)*	408.46	0.626E-21	Q(12.5) D	50	1875.596 20(22)*	145.55	0.742E-20	Q(3.5) D
16	1872.852 17(26)*	408.45	0.626E-21	Q(12.5) C	51	1875.596 80(22)*	145.55	0.742E-20	Q(3.5) C
17	1872.886 32(26)*	325.94	0.965E-22	Q(13.5) A	52	1875.606 75(22)*	40.16	0.109E-20	Q(4.5) B
18	1873.052 09(26)*	280.95	0.129E-21	Q(12.5) B	53	1875.722 56(21)*	133.51	0.106E-19	Q(2.5) D
19	1873.283 74(25)*	365.54	0.836E-21	Q(11.5) D	54	1875.722 80(21)*	133.51	0.106E-19	Q(2.5) C
20	1873.299 75(25)*	365.53	0.836E-21	Q(11.5) C	55	1875.724 26(22)*	40.10	0.110E-20	Q(4.5) A
21	1873.340 53(26)*	280.81	0.129E-21	Q(12.5) A	56	1875.772 42(22)*	25.11	0.148E-20	Q(3.5) B
22	1873.491 06(25)*	239.15	0.172E-21	Q(11.5) B	57	1875.812 79(21)*	124.91	0.172E-19	Q(1.5) D
23	1873.699 33(25)*	326.03	0.111E-20	Q(10.5) D	58	1875.812 85(21)*	124.91	0.172E-19	Q(1.5) C
24	1873.711 78(25)*	326.03	0.111E-20	Q(10.5) C	59	1875.866 78(22)*	25.06	0.148E-20	Q(3.5) A
25	1873.759 89(25)*	239.02	0.172E-21	Q(11.5) A	60	1875.903 93(21)*	13.40	0.212E-20	Q(2.5) B
26	1873.895 80(25)*	200.70	0.226E-21	Q(10.5) B	61	1875.974 91(21)*	13.36	0.212E-20	Q(2.5) A
27	1874.078 79(25)*	289.96	0.145E-20	Q(9.5) D	62	1876.001 29(21)*	5.03	0.343E-20	Q(1.5) B
28	1874.088 22(25)*	289.95	0.145E-20	Q(9.5) C	63	1876.048 70(21)*	5.01	0.343E-20	Q(1.5) A
29	1874.144 45(25)*	200.57	0.226E-21	Q(10.5) A	64	1876.064 47(21)*	0.01	0.878E-20	Q(0.5) B
30	1874.266 35(25)*	165.58	0.295E-21	Q(9.5) B	65	1876.088 21(21)*	0.00	0.878E-20	Q(0.5) A
31	1874.422 09(24)*	257.31	0.189E-20	Q(8.5) D					
32	1874.429 02(24)*	257.30	0.189E-20	Q(8.5) C					
33	1874.494 30(25)*	165.47	0.295E-21	Q(9.5) A					
34	1874.602 73(24)*	133.81	0.383E-21	Q(8.5) B					
35	1874.729 24(24)*	228.09	0.245E-20	Q(7.5) D					

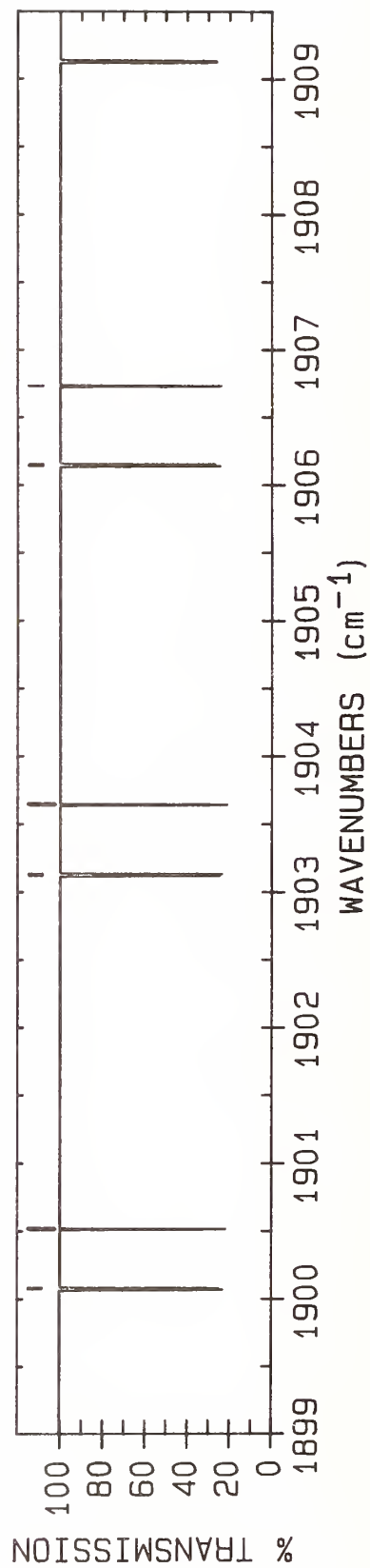
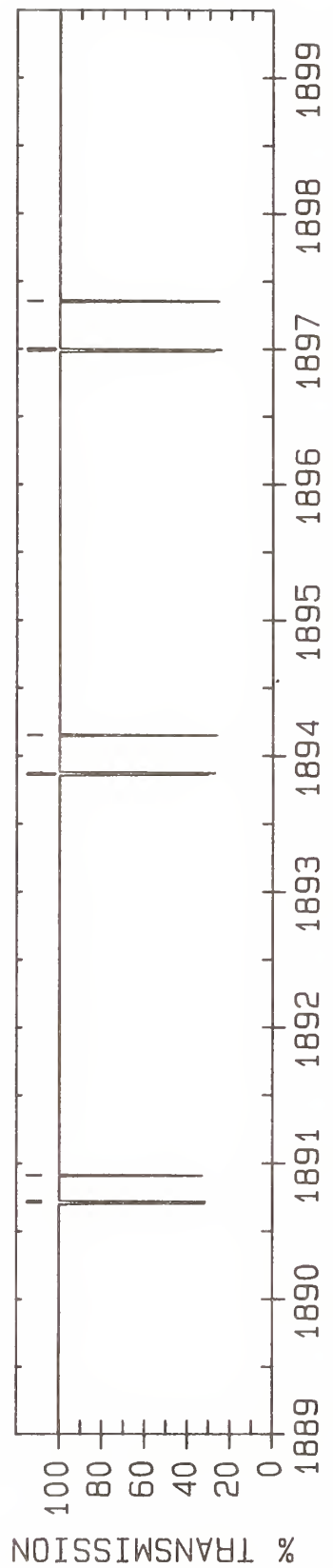
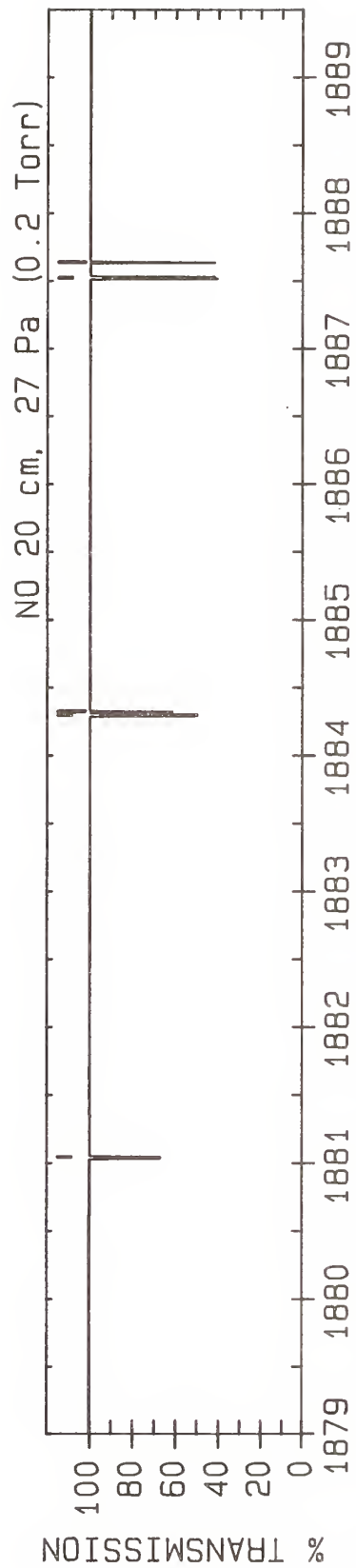

LINE #	WAVENUMBER(cm ⁻¹)	LOWER STATE (cm ⁻¹)	INTENSITY (cm/molecule)	ASSIGNMENT ROTATION BAND	LINE #	WAVENUMBER(unc) (cm ⁻¹)	LOWER STATE (cm ⁻¹)	INTENSITY (cm/molecule)	ASSIGNMENT ROTATION BAND
1	1881.034 99(21)*	0.00	0.176E-19	R(0.5) A	21	1897.353 10(23)*	179.95	0.342E-19	R(5.5) C
2	1881.046 80(21)*	0.01	0.176E-19	R(0.5) B	22	1897.353 68(23)*	179.95	0.342E-19	R(5.5) D
3	1884.293 37(21)*	5.01	0.310E-19	R(1.5) A	23	1900.070 70(24)*	80.22	0.675E-19	R(6.5) A
4	1884.305 12(21)*	5.03	0.310E-19	R(1.5) B	24	1900.081 69(24)*	80.30	0.674E-19	R(6.5) B
5	1884.323 16(21)*	124.91	0.115E-19	R(1.5) C	25	1900.517 17(24)*	202.30	0.359E-19	R(6.5) C
6	1884.323 25(21)*	124.91	0.115E-19	R(1.5) D	26	1900.517 93(24)*	202.30	0.359E-19	R(6.5) D
7	1887.517 50(22)*	13.36	0.426E-19	R(2.5) A	27	1903.122 90(24)*	105.29	0.679E-19	R(7.5) A
8	1887.529 14(22)*	13.40	0.426E-19	R(2.5) B	28	1903.133 67(24)*	105.38	0.678E-19	R(7.5) B
9	1887.636 25(22)*	133.51	0.198E-19	R(2.5) C	29	1903.643 47(24)*	228.08	0.363E-19	R(7.5) C
10	1887.636 43(22)*	133.51	0.198E-19	R(2.5) D	30	1903.644 43(24)*	228.09	0.363E-19	R(7.5) D
11	1890.707 34(22)*	25.06	0.522E-19	R(3.5) A	31	1906.140 51(25)*	133.71	0.662E-19	R(8.5) A
12	1890.718 85(22)*	25.11	0.522E-19	R(3.5) B	32	1906.151 06(25)*	133.81	0.662E-19	R(8.5) B
13	1890.912 42(22)*	145.55	0.262E-19	R(3.5) C	33	1906.731 81(25)*	257.30	0.355E-19	R(8.5) C
14	1890.912 71(22)*	145.55	0.262E-19	R(3.5) D	34	1906.732 98(25)*	257.31	0.355E-19	R(8.5) D
15	1893.862 86(23)*	40.10	0.597E-19	R(4.5) A					
16	1893.874 21(23)*	40.16	0.597E-19	R(4.5) B					
17	1894.151 45(23)*	161.03	0.310E-19	R(4.5) C					
18	1894.151 87(23)*	161.03	0.310E-19	R(4.5) D					
19	1896.983 99(23)*	58.49	0.648E-19	R(5.5) A					
20	1896.995 17(23)*	58.56	0.648E-19	R(5.5) B					

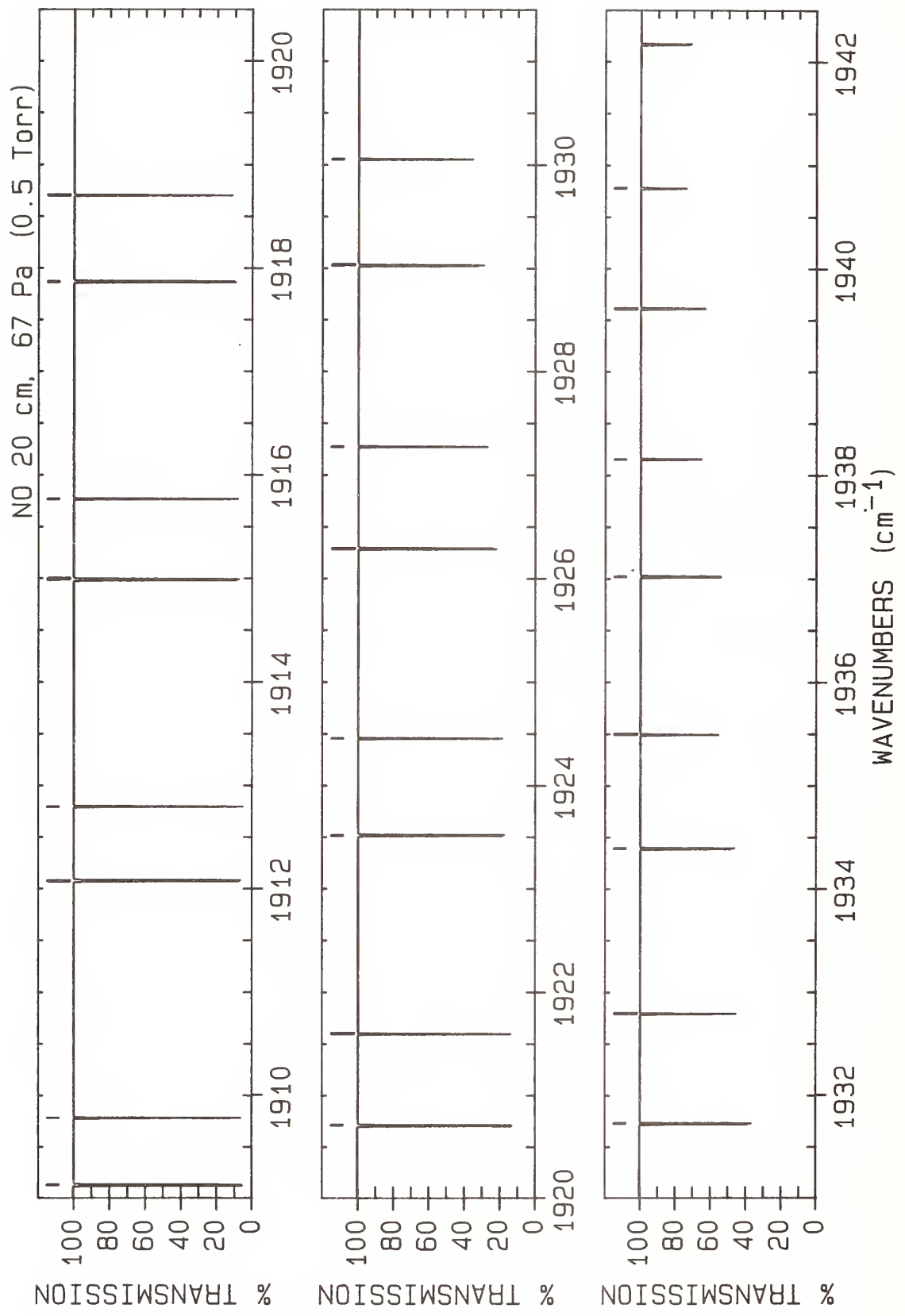

LINE #	WAVENUMBER(unc) (cm ⁻¹)	LOWER STATE (cm ⁻¹)	INTENSITY (cm/molecule)	ASSIGNMENT ROTATION BAND	LINE #	WAVENUMBER(unc) (cm ⁻¹)	LOWER STATE (cm ⁻¹)	INTENSITY (cm/molecule)	ASSIGNMENT ROTATION BAND
1	1909.123 44(26)*	165.47	0.628E-19	R(9.5) A	26	1926.294 78(32)*	426.39	0.281E-19	R(15.5) B
2	1909.133 73(26)*	165.58	0.628E-19	R(9.5) B	27	1927.273 62(32)*	557.74	0.147E-19	R(15.5) C
3	1909.782 00(26)*	289.95	0.337E-19	R(9.5) C	28	1927.276 55(32)*	557.76	0.147E-19	R(15.5) D
4	1909.783 40(26)*	289.96	0.337E-19	R(9.5) D	29	1929.022 78(33)*	481.37	0.228E-19	R(16.5) A
5	1912.071 58(27)*	200.57	0.581E-19	R(10.5) A	30	1929.031 16(33)*	481.55	0.228E-19	R(16.5) B
6	1912.081 63(27)*	200.70	0.581E-19	R(10.5) B	31	1930.052 71(33)	614.33	0.119E-19	R(16.5) C
7	1912.793 90(27)*	326.03	0.311E-19	R(10.5) C	32	1930.055 91(33)	614.35	0.119E-19	R(16.5) D
8	1912.795 53(27)*	326.03	0.311E-19	R(10.5) D	33	1931.723 65(34)*	539.87	0.182E-19	R(17.5) A
9	1914.984 82(28)*	239.02	0.525E-19	R(11.5) A	34	1931.731 75(34)*	540.05	0.182E-19	R(17.5) B
10	1914.994 61(28)*	239.15	0.525E-19	R(11.5) B	35	1932.792 57(34)	674.32	0.941E-20	R(17.5) C
11	1915.767 33(28)*	365.53	0.280E-19	R(11.5) C	36	1932.796 04(34)	674.35	0.941E-20	R(17.5) D
12	1915.769 21(28)*	365.54	0.280E-19	R(11.5) D	37	1934.388 57(36)	601.69	0.142E-19	R(18.5) A
13	1917.863 04(29)*	280.81	0.464E-19	R(12.5) A	38	1934.396 39(36)	601.89	0.142E-19	R(18.5) B
14	1917.872 55(29)*	280.95	0.463E-19	R(12.5) B	39	1935.493 10(36)	737.72	0.730E-20	R(18.5) C
15	1918.702 15(29)*	408.45	0.247E-19	R(12.5) C	40	1935.496 84(36)	737.75	0.730E-20	R(18.5) D
16	1918.704 29(29)*	408.46	0.247E-19	R(12.5) D	41	1937.017 36(38)	666.86	0.109E-19	R(19.5) A
17	1920.706 09(30)*	325.94	0.401E-19	R(13.5) A	42	1937.024 89(38)	667.06	0.109E-19	R(19.5) B
18	1920.715 32(30)*	326.09	0.400E-19	R(13.5) B	43	1938.154 20(38)	804.52	0.556E-20	R(19.5) C
19	1921.598 22(30)*	454.80	0.212E-19	R(13.5) C	44	1938.158 20(38)	804.55	0.556E-20	R(19.5) D
20	1921.600 63(30)*	454.81	0.212E-19	R(13.5) D	45	1939.609 82(40)	735.36	0.820E-20	R(20.5) A
21	1923.513 83(31)*	374.41	0.339E-19	R(14.5) A	46	1939.617 08(40)	735.57	0.820E-20	R(20.5) B
22	1923.522 78(31)*	374.57	0.339E-19	R(14.5) B	47	1940.775 78(40)	874.72	0.415E-20	R(20.5) C
23	1924.455 42(31)*	504.56	0.179E-19	R(14.5) C	48	1940.780 03(40)	874.75	0.415E-20	R(20.5) D
24	1924.458 09(31)*	504.58	0.179E-19	R(14.5) D					
25	1926.286 11(32)*	426.22	0.281E-19	R(15.5) A					

APPENDIX

Useful Equations and Formulas

Conversion factors

dipole moment or transition moment:

$$1 \text{ debye} = 3.335\,64 \times 10^{-30} \text{ coulomb meter}$$

wavenumber:

$$1 \text{ cm}^{-1} = 29\,979.2458 \text{ MHz}$$

pressure:

$$1 \text{ atm} = 101\,325 \text{ Pa (pascal)}$$

$$1 \text{ torr} = 133.322 \text{ Pa}$$

absorption intensity:

$$1 \text{ cm}^2 \text{ atm}^{-1} \text{ at } 296 \text{ K} = 4.033 \times 10^{-20} \text{ cm} / \text{molecule}$$

Useful equations

Boltzmann factor:

$$N_i = N_j \exp(-1.439 E_{ij}/T),$$

where N_i is the population of the i 'th level and N_j is the population of the j 'th level with energy difference in cm^{-1} of E_{ij} at a temperature of T kelvin.

Doppler half-width at half intensity, γ_D :

$$\gamma_D = 3.581 \times 10^{-7} \nu (T/M)^{1/2},$$

where ν is the frequency in the same units as γ_D , T is the temperature in kelvin, and M is the mass of the molecule in atomic mass units.

Peak intensity of a Doppler shaped line:

$$\% \text{ transmission} = 100 \exp(-1.1494 \times 10^{14} S l p / \gamma_D),$$

where S is the intensity given in the tables, l is the pathlength in cm, and p is the pressure in Pa.

Peak intensity of a Lorentzian line:

$$\% \text{ transmission} = 100 \exp(-0.7789 \times 10^{14} S l p / \gamma_L),$$

where S is the intensity given in the tables, γ_L is the Lorentzian half-width at half height, l is the pathlength in cm, and p is the pressure in Pa.

B 14A (5 D) BIBLIOGRAPHIC DATA SHEET	U.S. DEPARTMENT OF COMMERCE NATIONAL INSTITUTE OF STANDARDS AND TECHNOLOGY	1. PUBLICATION OR REPORT NUMBER NIST SP 821
		2. PERFORMING ORGANIZATION REPORT NUMBER
		3. PUBLICATION DATE December 1991

4. TITLE AND SUBTITLE
 Wavenumber Calibration Tables From Heterodyne Frequency Measurements

5. AUTHOR(S)
 Arthur G. Maki and Joseph S. Wells

6. PERFORMING ORGANIZATION (IF JOINT OR OTHER THAN NIST, SEE INSTRUCTIONS) U.S. DEPARTMENT OF COMMERCE NATIONAL INSTITUTE OF STANDARDS AND TECHNOLOGY GOLDEN, COLORADO 80303-3328	7. CONTRACT/GRANT NUMBER
	8. TYPE OF REPORT AND PERIOD COVERED Final

9. SPONSORING ORGANIZATION NAME AND COMPLETE ADDRESS (STREET, CITY, STATE, ZIP)
 National Institute of Standards and Technology
 NASA Upper Atmospheric Research Program, Washington, DC 20548

10. SUPPLEMENTARY NOTES

11. ABSTRACT (A 200-WORD OR LESS FACTUAL SUMMARY OF MOST SIGNIFICANT INFORMATION. IF DOCUMENT INCLUDES A SIGNIFICANT BIBLIOGRAPHY OR LITERATURE SURVEY, MENTION IT HERE.)

This new calibration atlas is based on frequency rather than wavelength calibration techniques for absolute references. Since a limited number of absolute frequency measurements is possible, additional data from alternate methodology is used for reference frequency measurements within each band investigated by frequency measurement techniques. Data from these complementary techniques includes the best Fourier transform measurements available. Included in the text portion of the atlas are a description of the heterodyne frequency measurement techniques, details of the analysis including the Hamiltonians and least-squares-fitting and calculation procedures. Also included here are other relevant considerations such as intensities and lineshape parameters. A 350 entry bibliography which contains all data sources used and a subsequent section on errors include the text portion.

The larger portion of the atlas consists of several hundred spectral-maps/facing-tables pages for the various calibration molecules. The spectral maps (as well as the facing tables) are calculated from the molecular constants derived for the work. The primary calibration molecules are the linear triatomics, carbonyl sulfide and nitrous oxide, which cover portions of the infrared spectrum ranging from 488 to 2960 cm⁻¹. Some gaps in the coverage afforded by OCS and N₂O are partially covered by NO, CO and CS₂. An additional region from 4000 to 4500 cm⁻¹ based on Co and N₂O is also included.

12. KEY WORDS (6 TO 12 ENTRIES; ALPHABETICAL ORDER; CAPITALIZE ONLY PROPER NAMES; AND SEPARATE KEY WORDS BY SEMICOLONS)
 calibration atlas; carbonyl sulfide; carbon monoxide; carbon disulfide; IR frequency calibrations; IR wavenumber calibrations; nitric oxide; nitrous oxide; wavenumber tables

13. AVAILABILITY <input type="checkbox"/> UNLIMITED <input type="checkbox"/> FOR OFFICIAL DISTRIBUTION. DO NOT RELEASE TO NATIONAL TECHNICAL INFORMATION SERVICE (NTIS). <input type="checkbox"/> ORDER FROM SUPERINTENDENT OF DOCUMENTS, U.S. GOVERNMENT PRINTING OFFICE, WASHINGTON, DC 20402. <input type="checkbox"/> ORDER FROM NATIONAL TECHNICAL INFORMATION SERVICE (NTIS), SPRINGFIELD, VA 22161.	14. NUMBER OF PRINTED PAGES 645
	15. PRICE

NIST *Technical Publications*

Periodical

Journal of Research of the National Institute of Standards and Technology—Reports NIST research and development in those disciplines of the physical and engineering sciences in which the Institute is active. These include physics, chemistry, engineering, mathematics, and computer sciences.

Papers cover a broad range of subjects, with major emphasis on measurement methodology and the basic technology underlying standardization. Also included from time to time are survey articles on topics closely related to the Institute's technical and scientific programs. Issued six times a year.

Nonperiodicals

Monographs—Major contributions to the technical literature on various subjects related to the Institute's scientific and technical activities.

Handbooks—Recommended codes of engineering and industrial practice (including safety codes) developed in cooperation with interested industries, professional organizations, and regulatory bodies.

Special Publications—Include proceedings of conferences sponsored by NIST, NIST annual reports, and other special publications appropriate to this grouping such as wall charts, pocket cards, and bibliographies.

Applied Mathematics Series—Mathematical tables, manuals, and studies of special interest to physicists, engineers, chemists, biologists, mathematicians, computer programmers, and others engaged in scientific and technical work.

National Standard Reference Data Series—Provides quantitative data on the physical and chemical properties of materials, compiled from the world's literature and critically evaluated. Developed under a worldwide program coordinated by NIST under the authority of the National Standard Data Act (Public Law 90-396). NOTE: The Journal of Physical and Chemical Reference Data (JPCRD) is published bimonthly for NIST by the American Chemical Society (ACS) and the American Institute of Physics (AIP). Subscriptions, reprints, and supplements are available from ACS, 1155 Sixteenth St., NW., Washington, DC 20056.

Building Science Series—Disseminates technical information developed at the Institute on building materials, components, systems, and whole structures. The series presents research results, test methods, and performance criteria related to the structural and environmental functions and the durability and safety characteristics of building elements and systems.

Technical Notes—Studies or reports which are complete in themselves but restrictive in their treatment of a subject. Analogous to monographs but not so comprehensive in scope or definitive in treatment of the subject area. Often serve as a vehicle for final reports of work performed at NIST under the sponsorship of other government agencies.

Voluntary Product Standards—Developed under procedures published by the Department of Commerce in Part 10, Title 15, of the Code of Federal Regulations. The standards establish nationally recognized requirements for products, and provide all concerned interests with a basis for common understanding of the characteristics of the products. NIST administers this program as a supplement to the activities of the private sector standardizing organizations.

Consumer Information Series—Practical information, based on NIST research and experience, covering areas of interest to the consumer. Easily understandable language and illustrations provide useful background knowledge for shopping in today's technological marketplace.

Order the above NIST publications from: Superintendent of Documents, Government Printing Office, Washington, DC 20402.

Order the following NIST publications—FIPS and NISTIRs—from the National Technical Information Service, Springfield, VA 22161.

Federal Information Processing Standards Publications (FIPS PUB)—Publications in this series collectively constitute the Federal Information Processing Standards Register. The Register serves as the official source of information in the Federal Government regarding standards issued by NIST pursuant to the Federal Property and Administrative Services Act of 1949 as amended, Public Law 89-306 (79 Stat. 1127), and as implemented by Executive Order 11717 (38 FR 12315, dated May 11, 1973) and Part 6 of Title 15 CFR (Code of Federal Regulations).

NIST Interagency Reports (NISTIR)—A special series of interim or final reports on work performed by NIST for outside sponsors (both government and non-government). In general, initial distribution is handled by the sponsor; public distribution is by the National Technical Information Service, Springfield, VA 22161, in paper copy or microfiche form.

U.S. Department of Commerce
National Institute of Standards and Technology
Gaithersburg, MD 20899

Official Business
Penalty for Private Use \$300

1