



121824-P1
Rev B, 1/99
Instruction Manual

MKS Type 660B Power Supply Digital Readout



WARRANTY

Type 660B Equipment

MKS Instruments, Inc. (**MKS**) warrants that for three years from the date of shipment the equipment described above (the "equipment") manufactured by **MKS** shall be free from defects in materials and workmanship and will correctly perform all date-related operations, including without limitation accepting data entry, sequencing, sorting, comparing, and reporting, regardless of the date the operation is performed or the date involved in the operation, provided that, if the equipment exchanges data or is otherwise used with equipment, software, or other products of others, such products of others themselves correctly perform all date-related operations and store and transmit dates and date-related data in a format compatible with **MKS** equipment. **THIS WARRANTY IS MKS' SOLE WARRANTY CONCERNING DATE-RELATED OPERATIONS.**

For the period commencing with the date of shipment of this equipment and ending three years later, **MKS** will, at its option, either repair or replace any part which is defective in materials or workmanship or with respect to the date-related operations warranty without charge to the purchaser. The foregoing shall constitute the exclusive and sole remedy of the purchaser for any breach by **MKS** of this warranty.

The purchaser, before returning any equipment covered by this warranty, which is asserted to be defective by the purchaser, shall make specific written arrangements with respect to the responsibility for shipping the equipment and handling any other incidental charges with the **MKS** sales representative or distributor from which the equipment was purchased or, in the case of a direct purchase from **MKS**, with the **MKS** home office in Andover, Massachusetts, USA.

This warranty does not apply to any equipment which has not been installed and used in accordance with the specifications recommended by **MKS** for the proper and normal use of the equipment. **MKS** shall not be liable under any circumstances for indirect, special, consequential, or incidental damages in connection with, or arising out of, the sale, performance, or use of the equipment covered by this warranty.

MKS recommends that all **MKS** pressure and flow products be calibrated periodically (typically every 6 to 12 months) to ensure accurate readings. When a product is returned to **MKS** for this periodic re-calibration it is considered normal preventative maintenance not covered by any warranty.

THIS WARRANTY IS IN LIEU OF ALL OTHER RELEVANT WARRANTIES, EXPRESSED OR IMPLIED, INCLUDING THE IMPLIED WARRANTY OF MERCHANTABILITY AND THE IMPLIED WARRANTY OF FITNESS FOR A PARTICULAR PURPOSE, AND ANY WARRANTY AGAINST INFRINGEMENT OF ANY PATENT.

**MKS Type 660B
Power Supply
Digital Readout**

Copyright © 1999 by MKS Instruments, Inc.

All rights reserved. No part of this work may be reproduced or transmitted in any form or by any means, electronic or mechanical, including photocopying and recording, or by any information storage or retrieval system, except as may be expressly permitted in writing by MKS Instruments, Inc.

Printed in the United States of America

Baratron® is a registered trademark of MKS Instruments, Inc., Andover, MA

Table of Contents

Safety Information.....	1
Symbols Used in This Instruction Manual.....	1
Symbols Found on the Unit	2
Safety Procedures and Precautions	3
Sicherheitshinweise	5
In dieser Betriebsanleitung vorkommende Symbole	5
Am Gerät angebrachte Symbole.....	6
Sicherheitsvorschriften und Vorsichtsmaßnahmen.....	7
Informations relatives à la sécurité.....	9
Symboles utilisés dans ce manuel d'utilisation	9
Symboles apparaissant sur l'appareil	10
Mesures de sécurité et mises en garde	11
Información sobre seguridad.....	13
Símbolos usados en el manual de instrucciones.....	13
Símbolos que aparecen en la unidad.....	14
Procedimientos y precauciones de seguridad	15
Chapter One: General Information.....	17
Introduction	17
How This Manual is Organized.....	18
Customer Support.....	19
Chapter Two: Installation	21
How To Unpack the Type 660 Unit	21
Unpacking Checklist	21
Interface Cables	22
Replacing a Type 660A Unit with a Type 660B Unit.....	23
Generic Shielded Cable Description	24
Product Location and Requirements.....	25
Operating Environmental Requirements	25

Safety Conditions	25
Electrical Requirements	25
Mounting Requirements.....	25
Setup.....	26
Dimensions.....	26
Mounting the Unit	27
Electrical Information.....	28
Connectors.....	28
Input Signal Wiring	31
Pressure Output Wiring.....	31
Chapter Three: Overview	33
Front Panel.....	33
The [MENU] Key.....	33
Set Points	34
Activated Alarms	34
Alarms.....	35
Hysteresis.....	36
The CAL Number	37
Decimal Point Position.....	37
Overrange Display.....	37
Labels	38
Serial Number Label.....	38
Information Labels.....	38
Chapter Four: Operation	39
General Information	39
How To Use the Menus.....	39
Changing Entries	40
How To Exit the Menu.....	40
How To Change the Decimal Point Position.....	40
How To Set the Zero Reading	41
How To Use the Remote Zero	41
How To Calibrate the Full Scale Reading	42

Calculating the CAL Number	42
Positioning the Decimal Point	44
Calibrating the Full Scale Voltage	44
Example 1: 100 Torr Transducer with Pressure Expressed in Torr	45
Example 2: 2 Torr Transducer with Pressure Expressed in Torr	46
Example 3: 100 Torr Transducer with Pressure Expressed in Pascal	48
Example 4: 5000 sccm MFC with Flow Expressed in sccm	50
Example 5: 30,000 sccm MFC with Flow Expressed in slm	52
How To Configure the Set Points.....	54
How To Deactivate An Alarm.....	55
How To Set the Hysteresis Value.....	55
Chapter Five: RS-232 Communications.....	57
General Information.....	57
Cabling	57
RS-232 Communication Parameters.....	58
How To Change the RS-232 Communication Parameters	58
RS-232 Protocol	60
Message Syntax.....	60
Errors	60
Serial Lockout.....	60
RS-232 Messages	61
Command Messages.....	61
Request Messages	63
Chapter Six: Maintenance.....	65
General Information.....	65
How To Clean the Unit	65
How To Replace the Fuses.....	65
Appendix A: Product Specifications	67
Performance Specifications	67
Electrical Specifications.....	68
Physical Specifications	69
RS-232 (Option) Specifications	69

Table of Contents

Appendix B: Model Code Explanation.....	71
Model Code	71
Appendix C: Engineering Unit Conversion Factors.....	73
Pressure Units	73
Mass Flow Units	73
Appendix D: Gas Correction Factors.....	75
Gas Correction Factor for Pure Gases	75
Index	79

List of Figures

Figure 1: Front Panel of the Type 660 Unit	26
Figure 2: Side Panel of the Type 660 Unit.....	26
Figure 3: Bottom View of the Type 660 Unit	27
Figure 4: The Rear Panel.....	28
Figure 5: Front Panel Identification	33
Figure 6: Action of the Set Point High Alarm.....	34
Figure 7: Action of the Set Point Low Alarm	35
Figure 8: Serial Number Label	38
Figure 9: Power Consumption Information Label	38
Figure 10: Fuse Information Label	38
Figure 11: Cabling Connections for RS-232 Communication	57
Figure 12: Location of the Switches for RS-232 Communication	59

List of Tables

Table 1: Definition of Symbols Found on the Unit	2
Tabelle 2: Definitionen der am Gerät angebrachten Symbole	6
Tableau 3: Définition des symboles apparaissant sur l'appareil	10
Tabla 4: Definición de los símbolos que aparecen en la unidad	14
Table 5: Interface Cables	22
Table 6: Transducer Connector Pin Assignments	29
Table 7: I/O Connector Pin Assignments	30
Table 8: Connections for the Signal Input	31
Table 9: Connections for the Pressure Output	31
Table 10: Action of the Set Point Values	34
Table 11: The [MENU] Key Selections	39
Table 12: RS-232 Pin Assignments on the I/O Connector	57
Table 13: RS-232 Communication Parameters	58
Table 14: Baud Rate Settings	59
Table 15: Parity Settings	59
Table 16: RS-232 Command Messages	61
Table 17: RS-232 Request Messages	63
Table 18: Fuse Information	65

Safety Information

Symbols Used in This Instruction Manual

Definitions of WARNING, CAUTION, and NOTE messages used throughout the manual.

Warning  The **WARNING** sign denotes a hazard. It calls attention to a procedure, practice, condition, or the like, which, if not correctly performed or adhered to, could result in injury to personnel.

Caution  The **CAUTION** sign denotes a hazard. It calls attention to an operating procedure, practice, or the like, which, if not correctly performed or adhered to, could result in damage to or destruction of all or part of the product.

Note  The **NOTE** sign denotes important information. It calls attention to a procedure, practice, condition, or the like, which is essential to highlight.

Symbols Found on the Unit

The following table describes symbols that may be found on the unit.















Definition of Symbols Found on the Unit			
			
On (Supply) IEC 417, No.5007	Off (Supply) IEC 417, No.5008	Earth (ground) IEC 417, No.5017	Protective earth (ground) IEC 417, No.5019
			
Frame or chassis IEC 417, No.5020	Equipotentiality IEC 417, No.5021	Direct current IEC 417, No.5031	Alternating current IEC 417, No.5032
			
Both direct and alternating current IEC 417, No.5033-a	Class II equipment IEC 417, No.5172-a	Three phase alternating current IEC 617-2 No.020206	
			
Caution, refer to accompanying documents ISO 3864, No.B.3.1	Caution, risk of electric shock ISO 3864, No.B.3.6	Caution, hot surface IEC 417, No.5041	

Table 1: Definition of Symbols Found on the Unit

Safety Procedures and Precautions

The following general safety precautions must be observed during all phases of operation of this instrument. Failure to comply with these precautions or with specific warnings elsewhere in this manual violates safety standards of intended use of the instrument and may impair the protection provided by the equipment. MKS Instruments, Inc. assumes no liability for the customer's failure to comply with these requirements.

DO NOT SUBSTITUTE PARTS OR MODIFY INSTRUMENT

Do not install substitute parts or perform any unauthorized modification to the instrument. Return the instrument to an MKS Calibration and Service Center for service and repair to ensure that all safety features are maintained.

SERVICE BY QUALIFIED PERSONNEL ONLY

Operating personnel must not remove instrument covers. Component replacement and internal adjustments must be made by qualified service personnel only.

GROUNDING THE PRODUCT

This product is grounded through the grounding conductor of the power cord. To avoid electrical shock, plug the power cord into a properly wired receptacle before connecting it to the product input or output terminals. A protective ground connection by way of the grounding conductor in the power cord is essential for safe operation.

DANGER ARISING FROM LOSS OF GROUND

Upon loss of the protective-ground connection, all accessible conductive parts (including knobs and controls that may appear to be insulating) can render an electrical shock.

GROUND AND USE PROPER ELECTRICAL FITTINGS

Dangerous voltages are contained within this instrument. All electrical fittings and cables must be of the type specified, and in good condition. All electrical fittings must be properly connected and grounded.

USE THE PROPER POWER CORD

Use only a power cord that is in good condition and which meets the input power requirements specified in the manual.

Use only a detachable cord set with conductors that have a cross-sectional area equal to or greater than 0.75 mm². The power cable should be approved by a qualified agency such as VDE, Semko, or SEV.

USE THE PROPER POWER SOURCE

This product is intended to operate from a power source that does not apply more voltage between the supply conductors, or between either of the supply conductors and ground, than that specified in the manual.

USE THE PROPER FUSE

Use only a fuse of the correct type, voltage rating, and current rating, as specified for your product.

DO NOT OPERATE IN EXPLOSIVE ATMOSPHERES

To avoid explosion, do not operate this product in an explosive environment unless it has been specifically certified for such operation.

HIGH VOLTAGE DANGER

High voltage is present in the cable, and in the sensor when the controller is turned on.

Sicherheitshinweise

In dieser Betriebsanleitung vorkommende Symbole

Definition der mit WARNUNG!, VORSICHT! und HINWEIS überschriebenen Abschnitte in dieser Betriebsanleitung.

Warnung!



Das Symbol **WARNUNG!** weist auf eine Gefahrenquelle hin. Es macht auf einen Arbeitsablauf, eine Arbeitsweise, einen Zustand oder eine sonstige Gegebenheit aufmerksam, deren unsachgemäße Ausführung bzw. ungenügende Berücksichtigung zu Körperverletzung führen kann.

Vorsicht!



Das Symbol **VORSICHT!** weist auf eine Gefahrenquelle hin. Es macht auf einen Bedienungsablauf, eine Arbeitsweise oder eine sonstige Gegebenheit aufmerksam, deren unsachgemäße Ausführung bzw. ungenügende Berücksichtigung zu einer Beschädigung oder Zerstörung des Produkts oder von Teilen des Produkts führen kann.

Hinweis



Das Symbol **HINWEIS** weist auf eine wichtige Mitteilung hin, die auf einen Arbeitsablauf, eine Arbeitsweise, einen Zustand oder eine sonstige Gegebenheit von besonderer Wichtigkeit aufmerksam macht.

Am Gerät angebrachte Symbole

Der untenstehenden Tabelle sind die Bedeutungen der Symbole zu entnehmen, die an dem Gerät angebracht sind.















Definitionen der am Gerät angebrachten Symbole			
			
Ein (Netz) IEC 417, Nr. 5007	Aus (Netz) IEC 417, Nr. 5008	Erde IEC 417, Nr. 5017	Schutzleiter IEC 417, Nr. 5019
			
Rahmen oder Chassis IEC 417, Nr. 5020	Äquipotentialanschluß IEC 417, Nr. 5021	Gleichstrom IEC 417, Nr. 5031	Wechselstrom IEC 417, Nr. 5032
			
Wechselstrom und Gleichstrom IEC 417, Nr. 5033-a	Geräteklasse II IEC 417, Nr. 5172-a	Drehstrom IEC 617-2 Nr. 020206	
			
Vorsicht! Bitte Begleitdokumente lesen! ISO 3864, Nr. B.3.1	Vorsicht! Stromschlaggefahr! ISO 3864, Nr. B.3.6	Vorsicht! Heiße Fläche! IEC 417, Nr. 5041	

Tabelle 2: Definitionen der am Gerät angebrachten Symbole

Sicherheitsvorschriften und Vorsichtsmaßnahmen

Die untenstehenden allgemeinen Sicherheitsvorschriften sind bei allen Betriebsphasen dieses Instruments zu befolgen. Jede Mißachtung dieser Sicherheitsvorschriften oder sonstiger spezifischer Warnhinweise in dieser Betriebsanleitung stellt eine Zuwiderhandlung der für dieses Instrument geltenden Sicherheitsstandards dar und kann die an diesem Instrument vorgesehenen Schutzvorrichtungen unwirksam machen. MKS Instruments, Inc. haftet nicht für eine Mißachtung dieser Sicherheitsvorschriften seitens des Kunden.

Keine Teile austauschen und keine Veränderungen vornehmen!

Bauen Sie in das Instrument keine Ersatzteile ein, und nehmen Sie keine eigenmächtigen Änderungen am Gerät vor! Schicken Sie das Instrument zu Wartungs- und Reparaturzwecken an einen MKS-Kalibrierungs- und -Kundendienst ein! Dadurch wird sichergestellt, daß alle Sicherheitseinrichtungen voll funktionsfähig bleiben.

Wartung nur durch qualifizierte Fachleute!

Das Gehäuse des Instruments darf vom Bedienpersonal nicht geöffnet werden. Das Auswechseln von Bauteilen und das Vornehmen von internen Einstellungen ist nur von qualifizierten Fachleuten durchzuführen.

Produkt erden!

Dieses Produkt ist mit einer Erdleitung und einem Schutzkontakt am Netzstecker versehen. Um der Gefahr eines elektrischen Schlages vorzubeugen, ist das Netzkabel an einer vorschriftsmäßig geerdeten Schutzkontaktsteckdose anzuschließen, bevor es an den Eingangs- bzw. Ausgangsklemmen des Produkts angeschlossen wird. Das Instrument kann nur sicher betrieben werden, wenn es über den Erdleiter des Netzkabels und einen Schutzkontakt geerdet wird.

Gefährdung durch Verlust der Schutzerdung!

Geht die Verbindung zum Schutzleiter verloren, besteht an sämtlichen zugänglichen Teilen aus stromleitendem Material die Gefahr eines elektrischen Schlages. Dies gilt auch für Knöpfe und andere Bedienelemente, die dem Anschein nach isoliert sind.

Erdung und Verwendung geeigneter elektrischer Armaturen!

In diesem Instrument liegen gefährliche Spannungen an. Alle verwendeten elektrischen Armaturen und Kabel müssen dem angegebenen Typ entsprechen und sich in einwand-freiem Zustand befinden. Alle elektrischen Armaturen sind vorschriftsmäßig anzubringen und zu erden.

Richtiges Netzkabel verwenden!

Das verwendete Netzkabel muß sich in einwandfreiem Zustand befinden und den in der Betriebsanleitung enthaltenen Anschlußwerten entsprechen.

Das Netzkabel muß abnehmbar sein. Der Querschnitt der einzelnen Leiter darf nicht weniger als $0,75 \text{ mm}^2$ betragen. Das Netzkabel sollte einen Prüfvermerk einer zuständigen Prüfstelle tragen, z.B. VDE, Semko oder SEV.

Richtige Stromquelle verwenden!

Dieses Produkt ist für eine Stromquelle vorgesehen, bei der die zwischen den Leitern bzw. zwischen jedem der Leiter und dem Masseleiter anliegende Spannung den in dieser Betriebsanleitung angegebenen Wert nicht überschreitet.

Richtige Sicherung benutzen!

Es ist eine Sicherung zu verwenden, deren Typ, Nennspannung und Nennstromstärke den Angaben für dieses Produkt entsprechen.

Gerät nicht in explosiver Atmosphäre benutzen!

Um der Gefahr einer Explosion vorzubeugen, darf dieses Gerät nicht in der Nähe explosiver Stoffe eingesetzt werden, sofern es nicht ausdrücklich für diesen Zweck zertifiziert worden ist.

Hochspannungsgefahr!

Bei eingeschaltetem Steuerteil liegt im Kabel und im Sensor Hochspannung an.

Informations relatives à la sécurité

Symboles utilisés dans ce manuel d'utilisation

Définition des indications AVERTISSEMENT, ATTENTION et REMARQUE utilisées dans ce manuel.

Avertissement



L'indication AVERTISSEMENT signale un danger potentiel. Elle est destinée à attirer l'attention sur une procédure, une utilisation, une situation ou toute autre chose présentant un risque de blessure en cas d'exécution incorrecte ou de non-respect des consignes.

Attention



L'indication ATTENTION signale un danger potentiel. Elle est destinée à attirer l'attention sur une procédure, une utilisation, une situation ou toute autre chose présentant un risque d'endommagement ou de dégât d'une partie ou de la totalité de l'appareil en cas d'exécution incorrecte ou de non-respect des consignes.

Remarque



L'indication REMARQUE signale des informations importantes. Elle est destinée à attirer l'attention sur une procédure, une utilisation, une situation ou toute autre chose présentant un intérêt particulier.

Symboles apparaissant sur l'appareil

Le tableau suivant décrit les symboles apparaissant sur l'appareil.















Définition des symboles apparaissant sur l'appareil			
			
Marche (sous tension) IEC 417, No. 5007	Arrêt (hors tension) IEC 417, No. 5008	Terre (masse) IEC 417, No. 5017	Terre de protection (masse) IEC 417, No. 5019
			
Masse IEC 417, No. 5020	Equipotentialité IEC 417, No. 5021	Courant continu IEC 417, No. 5031	Courant alternatif IEC 417, No. 5032
			
Courant continu et alternatif IEC 417, No. 5033-a	Matériel de classe II IEC 417, No. 5172-a	Courant alternatif triphase IEC 617-2 No. 020206	
			
Attention : se reporter à la documentation ISO 3864, No. B.3.1	Attention : risque de secousse électrique ISO 3864, No. B.3.6	Attention : surface brûlante IEC 417, No. 5041	

Tableau 3: Définition des symboles apparaissant sur l'appareil

Mesures de sécurité et mises en garde

Prendre toutes les précautions générales suivantes pendant toutes les phases d'utilisation de cet appareil. Le non-respect de ces précautions ou des avertissements contenus dans ce manuel entraîne une violation des normes de sécurité relatives à l'utilisation de l'appareil et le risque de réduire le niveau de protection fourni par l'appareil. MKS Instruments, Inc. ne prend aucune responsabilité pour les conséquences de tout non-respect des consignes de la part de ses clients.

NE PAS SUBSTITUER DES PIÈCES OU MODIFIER L'APPAREIL

Ne pas utiliser de pièces détachées autres que celles vendues par MKS Instruments, Inc. ou modifier l'appareil sans l'autorisation préalable de MKS Instruments, Inc. Renvoyer l'appareil à un centre d'étalonnage et de dépannage MKS pour tout dépannage ou réparation afin de s'assurer que tous les dispositifs de sécurité sont maintenus.

DÉPANNAGE EFFECTUÉ UNIQUEMENT PAR UN PERSONNEL QUALIFIÉ

L'opérateur de l'appareil ne doit pas enlever le capot de l'appareil. Le remplacement des composants et les réglages internes doivent être effectués uniquement par un personnel d'entretien qualifié.

MISE À LA TERRE DE L'APPAREIL

Cet appareil est mis à la terre à l'aide du fil de terre du cordon d'alimentation. Pour éviter tout risque de secousse électrique, brancher le cordon d'alimentation sur une prise de courant correctement câblée avant de le brancher sur les bornes d'entrée ou de sortie de l'appareil. Une mise à la terre de protection à l'aide du fil de terre du cordon d'alimentation est indispensable pour une utilisation sans danger de l'appareil.

DANGER LIÉ À UN DÉFAUT DE TERRE

En cas de défaut de terre, toutes les pièces conductrices accessibles (y compris les boutons de commande ou de réglage qui semblent être isolés) peuvent être source d'une secousse électrique.

MISE À LA TERRE ET UTILISATION CORRECTE D'ACCESSOIRES ÉLECTRIQUES

Des tensions dangereuses existent à l'intérieur de l'appareil. Tous les accessoires et les câbles électriques doivent être conformes au type spécifié et être en bon état. Tous les accessoires électriques doivent être correctement connectés et mis à la terre.

UTILISATION D'UN CORDON D'ALIMENTATION APPROPRIÉ

Utiliser uniquement un cordon d'alimentation en bon état et conforme aux exigences de puissance d'entrée spécifiées dans le manuel.

Utiliser uniquement un cordon d'alimentation amovible avec des conducteurs dont la section est égale ou supérieure à 0,75 mm². Le cordon d'alimentation doit être approuvé par un organisme compétent tel que VDE, Semko ou SEV.

UTILISATION D'UNE ALIMENTATION APPROPRIÉE

Cet appareil est conçu pour fonctionner en s'alimentant sur une source de courant électrique n'appliquant pas une tension entre les conducteurs d'alimentation, ou entre les conducteurs d'alimentation et le conducteur de terre, supérieure à celle spécifiée dans le manuel.

UTILISATION D'UN FUSIBLE APPROPRIÉ

Utiliser uniquement un fusible conforme au type, à la tension nominale et au courant nominal spécifiés pour l'appareil.

NE PAS UTILISER DANS UNE ATMOSPHÈRE EXPLOSIVE

Pour éviter tout risque d'explosion, ne pas utiliser l'appareil dans une atmosphère explosive à moins qu'il n'ait été approuvé pour une telle utilisation.

DANGER DE HAUTE TENSION

Une haute tension est présente dans le câble et dans le capteur lorsque le contrôleur est sous tension.

Información sobre seguridad

Símbolos usados en el manual de instrucciones

Definiciones de los mensajes de ADVERTENCIA, PRECAUCIÓN Y OBSERVACIÓN usados en el manual.

Advertencia  El símbolo de **ADVERTENCIA** indica un riesgo. **Pone de relieve un procedimiento, práctica, condición, etc., que, de no realizarse u observarse correctamente, podría causar lesiones a los empleados.**

Precaución  El símbolo de **PRECAUCIÓN** indica un riesgo. **Pone de relieve un procedimiento, práctica, etc., de tipo operativo que, de no realizarse u observarse correctamente, podría causar desperfectos al instrumento, o llegar incluso a causar su destrucción total o parcial.**

Observación  El símbolo de **OBSERVACIÓN** indica información de importancia. **Pone de relieve un procedimiento, práctica, condición, etc., cuyo conocimiento resulta esencial.**

Símbolos que aparecen en la unidad

En la tabla que figura a continuación se indican los símbolos que aparecen en la unidad.















Definición de los símbolos que aparecen en la unidad			
			
Encendido (alimentación eléctrica) IEC 417, N.º 5007	Apagado (alimentación eléctrica) IEC 417, N.º 5008	Puesta a tierra IEC 417, N.º 5017	Protección a tierra IEC 417, N.º 5019
			
Caja o chasis IEC 417, N.º 5020	Equipotencialidad IEC 417, N.º 5021	Corriente continua IEC 417, N.º 5031	Corriente alterna IEC 417, N.º 5032
			
Corriente continua y alterna IEC 417, N.º 5033-a	Equipo de clase II IEC 417, N.º 5172-a	Corriente alterna trifásica IEC 617-2 N.º 020206	
			
Precaución. Consultar los documentos adjuntos ISO 3864, N.º B.3.1	Precaución. Riesgo de descarga eléctrica ISO 3864, N.º B.3.6	Precaución. Superficie caliente IEC 417, N.º 5041	

Tabla 4: Definición de los símbolos que aparecen en la unidad

Procedimientos y precauciones de seguridad

Las precauciones generales de seguridad que figuran a continuación deben observarse durante todas las fases de funcionamiento del presente instrumento. La no observancia de dichas precauciones, o de las advertencias específicas a las que se hace referencia en el manual, contraviene las normas de seguridad referentes al uso previsto del instrumento y podría impedir la protección que proporciona el instrumento. MKS Instruments, Inc., no asume responsabilidad alguna en caso de que el cliente haga caso omiso de estos requerimientos.

NO UTILIZAR PIEZAS NO ORIGINALES NI MODIFICAR EL INSTRUMENTO

No se debe instalar piezas que no sean originales ni modificar el instrumento sin autorización. Para garantizar que las prestaciones de seguridad se observen en todo momento, enviar el instrumento al Centro de servicio y calibración de MKS cuando sea necesaria su reparación y servicio de mantenimiento.

REPARACIONES EFECTUADAS ÚNICAMENTE POR TÉCNICOS ESPECIALIZADOS

Los operarios no deben retirar las cubiertas del instrumento. El cambio de piezas y los reajustes internos deben efectuarlos únicamente técnicos especializados.

PUESTA A TIERRA DEL INSTRUMENTO

Este instrumento está puesto a tierra por medio del conductor de tierra del cable eléctrico. Para evitar descargas eléctricas, enchufar el cable eléctrico en una toma debidamente instalada, antes de conectarlo a las terminales de entrada o salida del instrumento. Para garantizar el uso sin riesgos del instrumento resulta esencial que se encuentre puesto a tierra por medio del conductor de tierra del cable eléctrico.

PELIGRO POR PÉRDIDA DE LA PUESTA A TIERRA

Si se pierde la conexión protectora de puesta a tierra, todas las piezas conductoras a las que se tiene acceso (incluidos los botones y mandos que pudieran parecer estar aislados) podrían producir descargas eléctricas.

PUESTA A TIERRA Y USO DE ACCESORIOS ELÉCTRICOS ADECUADOS

Este instrumento funciona con voltajes peligrosos. Todos los accesorios y cables eléctricos deben ser del tipo especificado y mantenerse en buenas condiciones. Todos los accesorios eléctricos deben estar conectados y puestos a tierra del modo adecuado.

USAR EL CABLE ELÉCTRICO ADECUADO

Usar únicamente un cable eléctrico que se encuentre en buenas condiciones y que cumpla los requisitos de alimentación de entrada indicados en el manual.

Usar únicamente un cable desmontable instalado con conductores que tengan un área de sección transversal equivalente o superior a 0,75mm². El cable eléctrico debe estar aprobado por una entidad autorizada como, por ejemplo, VDE, Semko o SEV.

USAR LA FUENTE DE ALIMENTACIÓN ELÉCTRICA ADECUADA

Este instrumento debe funcionar a partir de una fuente de alimentación eléctrica que no aplique más voltaje entre los conductores de suministro, o entre uno de los conductores de suministro y la puesta a tierra, que el que se especifica en el manual.

USAR EL FUSIBLE ADECUADO

Usar únicamente un fusible del tipo, clase de voltaje y de corriente adecuados, según lo que se especifica para el instrumento.

EVITAR SU USO EN ENTORNOS EXPLOSIVOS

Para evitar el riesgo de explosión, no usar este instrumento o en un entorno explosivo, a no ser que haya sido certificado para tal uso.

PELIGRO POR ALTO VOLTAJE

Cuando el controlador está encendido, se registra alto voltaje en el cable y en el sensor.

Chapter One: General Information

Introduction

The MKS Type 660B Power Supply Digital Readout contains a 4½ digit display packaged in a 1/8 DIN case. The 660 unit provides four alarm limits, (two high and two low) and an output voltage to power a transducer. Each alarm limit has an accompanying LED on the front panel so the status of the system is clearly visible. The unit provides adjustable hysteresis for the alarms to prevent false activation from noise. The zero and full scale settings are accessible through front panel controls. The 660 unit supports custom scaling so you can display the pressure readings in the units of your choice. The scaler, or CAL number, can range from 1 to 99,999. The 660 unit supports RS-232 communications, available as an option, through the I/O connector located on the unit's rear panel.

The 660 unit is available in four AC power ranges:

- 120 VAC nominal, (108 to 132 V) @ 50/60 Hz
- 240 VAC nominal, (216 to 264 V) @ 50/60 Hz
- 100 VAC nominal, (90 to 110 V) @ 50/60 Hz
- 220 VAC nominal, (198 to 242 V) @ 50/60 Hz

The 660 unit provides power for any pressure transducer or flow meter that can operate with ± 15 Volts ($\pm 5\%$) @ ≤ 250 milliamperes.

The 660 readout, when used with the proper cable, meets the European Community EMC Directive 89/336/EEC. This directive includes emissions and immunity specifications.

How This Manual is Organized

This manual is designed to provide instructions on how to set up and install a 660 unit.

Before installing your 660 unit in a system and/or operating it, carefully read and familiarize yourself with all precautionary notes in the *Safety Messages and Procedures* section at the front of this manual. In addition, observe and obey all WARNING and CAUTION notes provided throughout the manual.

Chapter One: General Information, (this chapter) introduces the product and describes the organization of the manual.

Chapter Two: Installation, explains the environmental requirements and describes how to mount the unit in your system.

Chapter Three: Overview, gives a brief description of the unit and its functionality.

Chapter Four: Operation, describes how to use the unit and explains all the functions and features.

Chapter Five: RS-232 Communications, lists the protocol and messages used to operate the 660 unit through optional RS-232 communications.

Chapter Six: Maintenance, provides a checklist for reference in the unlikely event your unit malfunctions.

Appendix A: Product Specifications, lists the specifications of the unit.

Appendix B: Model Code Explanation, explains the options selected through the model code.

Appendix C: Engineering Unit Conversion Factors, provides conversion factors for units used in pressure and flow systems.

Appendix D: Gas Correction Factors, lists the gas correction factors for common gases.

Customer Support

Standard maintenance and repair services are available at all of our regional MKS Calibration and Service Centers, listed on the back cover. In addition, MKS accepts the instruments of other manufacturers for recalibration using the Primary and Transfer Standard calibration equipment located at all of our regional service centers. Should any difficulties arise in the use of your Type 660 instrument, or to obtain information about companion products MKS offers, contact any authorized MKS Calibration and Service Center. If it is necessary to return the instrument to MKS, please obtain an ERA Number (Equipment Return Authorization Number) from the MKS Calibration and Service Center before shipping. The ERA Number expedites handling and ensures proper servicing of your instrument.

Please refer to the inside of the back cover of this manual for a list of MKS Calibration and Service Centers.

Warning

All returns to MKS Instruments must be free of harmful, corrosive, radioactive, or toxic materials.

This page intentionally left blank.

Chapter Two: Installation

How To Unpack the Type 660 Unit

MKS has carefully packed the Type 660 unit so that it will reach you in perfect operating order. Upon receiving the unit, however, you should check for defects, cracks, broken connectors, etc., to be certain that damage has not occurred during shipment.

Note

Do *not* discard any packing materials until you have completed your inspection and are sure the unit arrived safely.

If you find any damage, notify your carrier and MKS immediately. If it is necessary to return the unit to MKS, obtain an ERA Number (Equipment Return Authorization Number) from the MKS Service Center before shipping. Please refer to the inside of the back cover of this manual for a list of MKS Calibration and Service Centers.

Caution

Only qualified individuals should perform the installation and any user adjustments. They must comply with all the necessary ESD and handling precautions while installing and adjusting the instrument. Proper handling is essential when working with all highly sensitive precision electronic instruments.

Unpacking Checklist

Standard Equipment:

- Type 660 Unit
- Type 660 Instruction Manual (this book)
- Power cord

Optional Equipment:

- Electrical Connector Accessories Kit, 660B-K1 (includes mating connectors and an RFI hood)
- Any pressure transducer or flow meter than can be powered by ± 15 Volts ($\pm 5\%$) @ ≤ 250 mA
- Interface cables (refer to *Interface Cables*, page 22, for more information)

Companion Products

- MKS Baratron® Pressure Transducers: 121, 122, 124, 127, 220 (display only), 221, 223, 224, 422, 427, 622, 623, 624, 625, 626, 627
- MKS Mass Flow Meters: 176, 179, 258, 358, 558
- MKS Pressure Controllers: 250, 252

Interface Cables

As of January 1, 1996, most products shipped to the European Community must comply with the EMC Directive 89/336/EEC, which covers radio frequency emissions and immunity tests. In addition, as of January 1, 1997, some products shipped to the European Community must also comply with the Product Safety Directive 92/59/EEC and Low Voltage Directive 73/23/EEC, which cover general safety practices for design and workmanship. MKS products that meet these requirements are identified by application of the CE Mark.

To ensure compliance with EMC Directive 89/336/EEC, an overall metal braided shielded cable, properly grounded at both ends, is required during use. No additional installation requirements are necessary to ensure compliance with Directives 92/59/EEC and 73/23/EEC.

Interface Cables		
Pressure Products To Connect the 660 Unit to . . .	Use the MKS Cable . . .	
	Standard	Shielded
120A	CB120-6-10	CB120S-6-10
121A, 221B	CB112-14-10	CB112S-14-10
122A, 124A, 223B, 622A, 623A, 624A, 722A (with terminal strip)	CB112-2-10	CB112S-2-10
127A, 626A, 627A/B, 722A, and with 15-pin Type "D": 722A, 740B, 750B, 852B	CB259-5-10	CB259S-5-10
220C, 220D (display only)	CB112-10-10	CB112S-10-10
619C, 621C	CB1559-1-10	CB1559S-1-10
With 9-pin Type "D": 722A, 740B, 750B, 850B, 852B	CB700-1-10	CB700S-1-10
With Bendix connector: 740B, 750B, 850B, 852B	CB700-3-10	CB700S-3-10

Table 5: Interface Cables
(Continued on next page)

Interface Cables (Continued)		
Flow Products To Connect the 660 Unit to . . .	Use the MKS Cable . . .	
	Standard	Shielded
258C, 358C, 558A, 179A with 15-pin Type "D"	CB259-5-10	CB259S-5-10
179A with 9-pin Type "D"	CB147-12-10	CB147S-12-10
179A with 20-pin Edge Card	CB259-10-10	CB259S-10-10
Controllers To Connect the 660 Unit to . . .	Use the MKS Cable . . .	
	Standard	Shielded
250, 252	CB660-5-6	CB660S-5-6
I/O Connector to Flying Leads	Standard	Shielded
	CB660-4-6	CB660S-4-6
<i>xx indicates the cable length, in feet; standard length is 10 ft, unless noted otherwise</i>		

Table 5: Interface Cables

Replacing a Type 660A Unit with a Type 660B Unit

The I/O connector on the 660A unit differs from the 660B unit. The 660A unit uses an Edge Board connector whereas the 660B unit uses a 15-pin Type "D" connector. If you wish to replace a Type 660A unit with a Type 660B unit, you can purchase either:

- a new interface cable, as defined in Table 5, page 22
- or
- an adapter cable (CB660-6) and continue to use your existing interface cable

The adapter cable has a 5 inch section of ribbon cable to connect to the Edge Board connector on the 660A interface cable.

Caution



The adapter cable (CB660-6) uses a plastic connector to connect to the Edge Board connector. This adapter cable does not pass CE testing. If your unit must meet CE requirements, you must purchase a new interface cable. Refer to Table 5, page 22.

Generic Shielded Cable Description

MKS offers a full line of cables for all MKS equipment. Should you choose to manufacture your own cables, follow the guidelines listed below:

1. The cable must have an overall metal *braided* shield, covering all wires. Neither aluminum foil nor spiral shielding will be as effective; using either may nullify regulatory compliance.
2. The connectors must have a metal case which has direct contact to the cable's shield on the whole circumference of the cable. The inductance of a flying lead or wire from the shield to the connector will seriously degrade the shield's effectiveness. The shield should be grounded to the connector before its internal wires exit.
3. With very few exceptions, the connector(s) must make good contact to the device's case (ground). "Good contact" is about 0.01 ohms; and the ground should surround all wires. Contact to ground at just one point may not suffice.
4. For shielded cables with flying leads at one or both ends; it is important at each such end, to ground the shield *before* the wires exit. Make this ground with absolute minimum length. (A ¼ inch piece of #22 wire may be undesirably long since it has approximately 5 nH of inductance, equivalent to 31 ohms at 1000 MHz). After picking up the braid's ground, keep wires and braid flat against the case. With very few exceptions, grounded metal covers are not required over terminal strips. If one is required, it will be stated in the Declaration of Conformity or in the instruction manual.
5. In selecting the appropriate type and wire size for cables, consider:
 - A. The voltage ratings;
 - B. The cumulative I^2R heating of all the conductors (keep them safely cool);
 - C. The IR drop of the conductors, so that adequate power or signal voltage gets to the device;
 - D. The capacitance and inductance of cables which are handling fast signals, (such as data lines or stepper motor drive cables); and
 - E. That some cables may need internal shielding from specific wires to others; please see the instruction manual for details regarding this matter.

Product Location and Requirements

The Type 660 unit meets the following criteria:

- POLLUTION DEGREE 2 in accordance with IEC 664
- INSTALLATION CATEGORY II, for transient overvoltages, according to EN 61010-1

Operating Environmental Requirements

- Ambient Operating Temperature: 0° to 55° C (32° to 131° F)
- Main supply voltage fluctuations must not exceed $\pm 10\%$ of the nominal voltage
- Ventilation requirements include sufficient air circulation
- Connect the power cord into a grounded outlet

Safety Conditions

The 660B unit poses no safety risk under the following environmental conditions.

- Altitude: up to 2000 m
- Maximum relative humidity: 80% for temperatures up to 31° C, decreasing linearly to 50% at 40° C

Electrical Requirements

660B1x 120 VAC nominal—108 to 132 VAC @ 50/60 Hz

660B2x 240 VAC nominal—216 to 264 VAC @ 50/60 Hz

660B3x 100 VAC nominal—90 to 110 VAC @ 50/60 Hz

660B4x 220 VAC nominal—198 to 242 VAC @ 50/60 Hz

where x is 0 for the standard unit; 2 for the optional RS-232 communications

Note



To ensure proper operation, maintain a system ground.

Mounting Requirements

The panel cutout dimensions (panel mounting pawls are provided):

inches: 1.772" (+0.024, -0.000) by 3.622" (+0.032, -0.000)

millimeters: 45 mm (+0.6, -0.0) by 92 mm (+0.8, -0.0)

Setup

The 660 unit can function as a benchtop unit or as a mounted unit in an appropriately sized panel cutout. Refer to *Product Location and Requirements*, page 25, for the dimensional requirements.

Dimensions

Note



All dimensions are listed in inches with millimeters referenced in parentheses. The tolerances for the dimensions, unless noted otherwise, are ± 0.01 (.XX) inches and ± 0.005 (.XXX) inches.

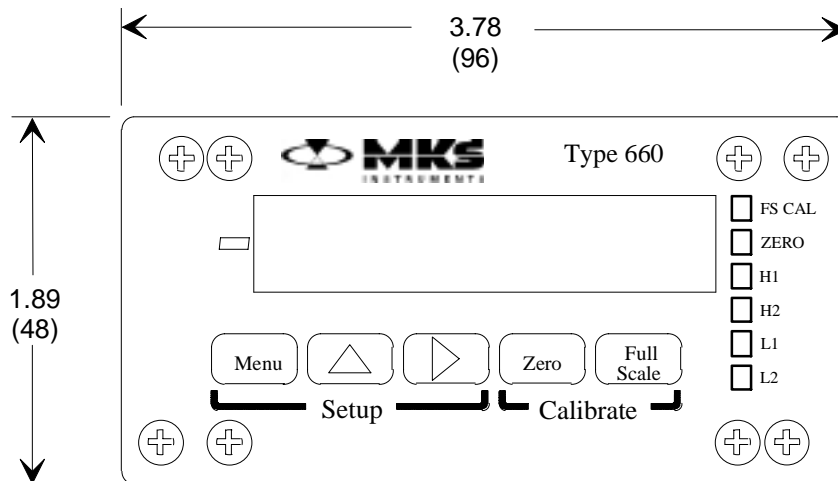

Figure 1: Front Panel of the Type 660 Unit

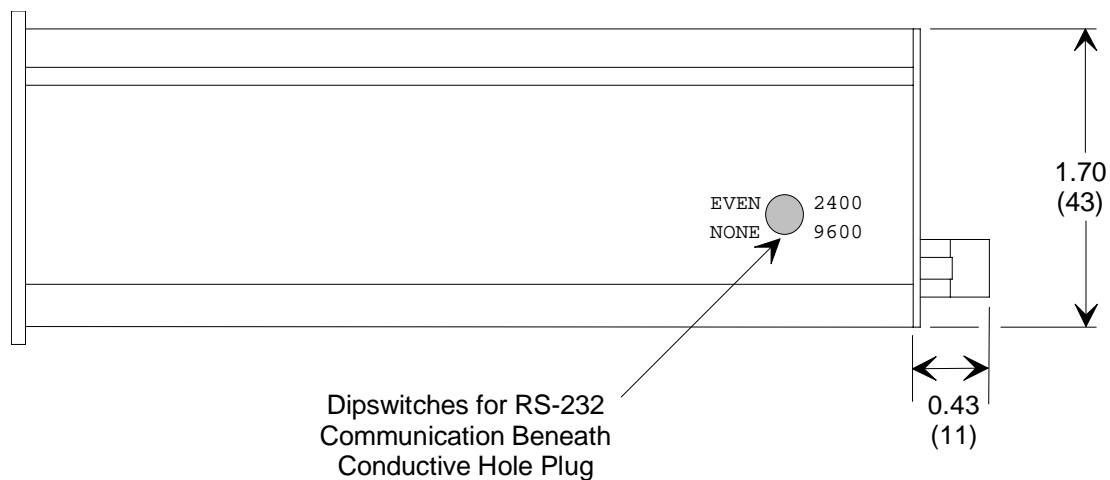

Figure 2: Side Panel of the Type 660 Unit

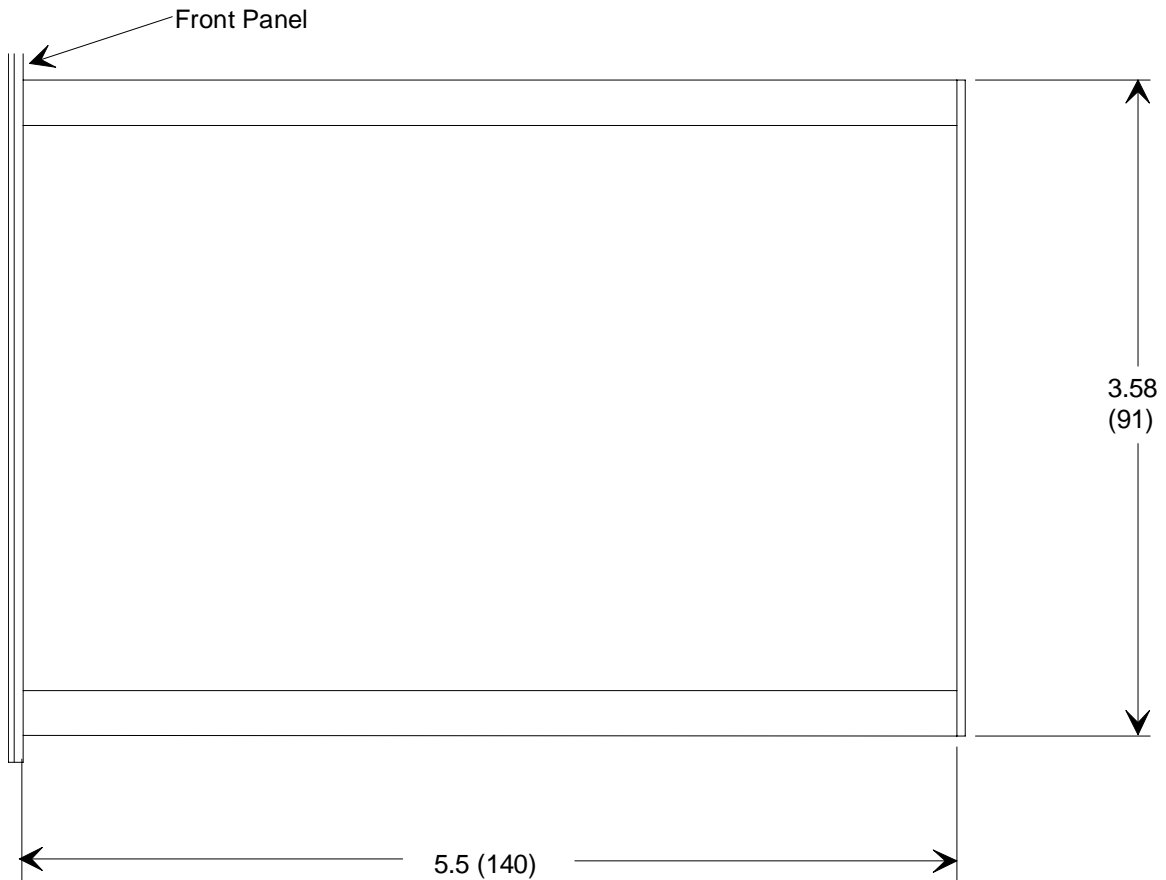

Figure 3: Bottom View of the Type 660 Unit

Mounting the Unit

Be sure to consider the accessibility of the unit when mounting it.

1. Use a Phillips head screwdriver to rotate the mounting (pawl) screws several turns counterclockwise to retract the pawls.

Refer to Figure 1, page 26, for the location of the mounting screws. Be certain that the mounting screws retract sufficiently to overlap the thickness of the mounting panel. The mounting screws may be retracted to accommodate panel thicknesses up to 0.25 inches.

2. Insert the unit into the panel cutout.

Refer to *Mounting Requirements*, page 25, for the panel cutout dimensions.

3. Tighten the mounting screws.

Electrical Information

Note



For protective earthing, be sure to plug the 660 unit into a properly grounded outlet.

Connectors

The 660 unit has two connectors, a transducer and an I/O connector, in addition to the power entry module. All of the connectors are located on the rear panel of the instrument.

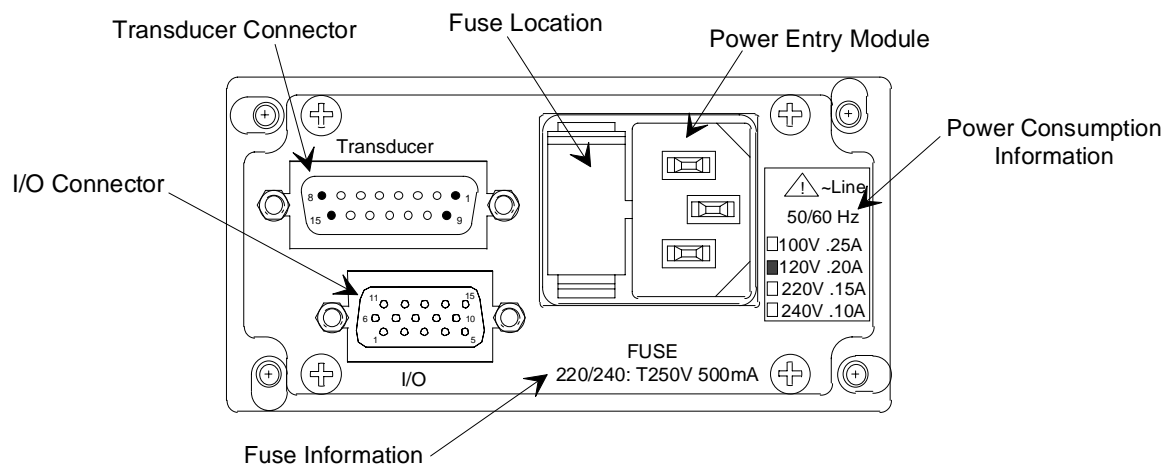

Figure 4: The Rear Panel

Note



For information on replacing the fuse, refer to *How To Replace the Fuses*, page 65.

Transducer Connector

The transducer connector is a 15-pin female Type “D” connector. Refer to Figure 4, page 28, for its location. Use this connector to attach a pressure transducer to the 660 unit.

Transducer Connector Pin Assignments	
Pin Number	Assignment
1	No Connection
2	Pressure Input (+)
3	No Connection
4	No Connection
5	Power Ground
6	15 V Supply (-)
7	15 V Supply (+)
8	No Connection
9	No Connection
10	No Connection
11	No Connection
12	Pressure Input (-)
13	No Connection
14	No Connection
15	Chassis Ground

Table 6: Transducer Connector Pin Assignments

Note

The “No Connection” pin assignment refers to a pin with no internal connection.

I/O Connector

The I/O connector is a 15-pin female High Density Type “D” connector. It provides the pressure output signal and the alarm signals. Pin 10 provides a remote zero function for the display; this function does not zero the pressure output signal.

I/O Connector Pin Assignments	
Pin Number	Assignment
1	TXD* (Transmit)
2	RXD* (Receive)
3	Reserved
4	Reserved
5	Digital Ground
6	Analog Ground (Connected to - Pressure Input)
7	Reserved
8	Reserved
9	Reserved
10	Remote Zero Display (Connect to Pin 5 to Activate)
11	Pressure Output**
12	Open Collector SP4
13	Open Collector SP3
14	Open Collector SP2
15	Open Collector SP1
<p><i>* Pins have functions for the RS-232 option; pins “reserved” for units without the RS-232 option.</i></p> <p><i>** Pressure output signal does not reflect any correction by the remote zero function.</i></p>	

Table 7: I/O Connector Pin Assignments

Note

The “No Connection” pin assignment refers to a pin with no internal connection. The “Reserved” pin assignment refers to a pin with an internal connection, that may be assigned a function in the future.

Input Signal Wiring

The input signal to the 660 unit must be within the range of 0 to ± 10 Volts. Table 8 describes how to connect an input signal (with no excitation supply) to the 660 unit.

Connections for the Signal Input	
Connection	Transducer Pin Number
Transducer Input (-)	12
Transducer Input (+)	2

Table 8: Connections for the Signal Input

Pressure Output Wiring

The 660 unit uses the Transducer connector to receive the pressure voltage from the transducer. The same voltage is available as a pressure output voltage on the I/O connector, if you need to connect the 660 unit to another instrument in series. The pressure output signal (0 to ± 10 Volts) must be connected to the I/O connector as a non-isolated signal.

Note



The pressure output signal does not reflect any correction by the remote zero function.

Table 9 lists the I/O connector pins for the pressure output. Refer to Table 7, page 30, for a complete list of the pin assignments for the I/O connector and Figure 4, page 28, for the location of the connector.

Connections for the Pressure Output	
Connection	Pin
Pressure Output*	11
Analog Ground	6
<i>* This signal does not contain the remote zero correction.</i>	

Table 9: Connections for the Pressure Output

This page intentionally left blank.

Chapter Three: Overview

Front Panel

The front panel allows access to all the features of the 660 unit. The keys are divided into “Setup” and “Calibrate” functions. The Setup keys allow you to configure the operating parameters of the 660 unit. The Calibrate keys enable you to zero the unit and set the full scale value. Status LEDs indicate the status of the instrument. Figure 5 identifies the front panel components.

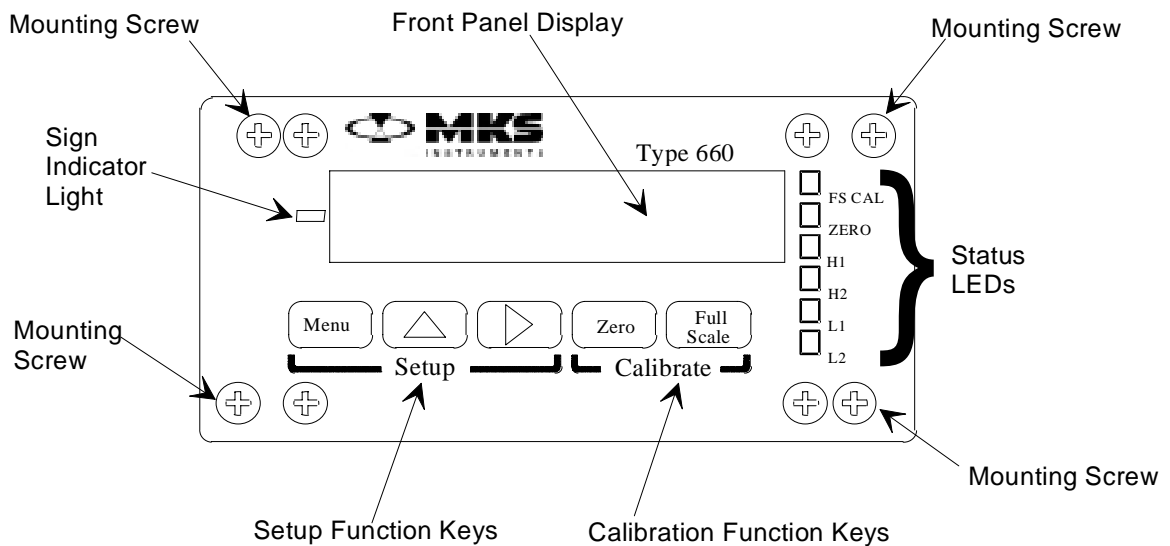

Figure 5: Front Panel Identification

The [MENU] Key

The 660 unit contains several configuration screens. To access these screens, press the [MENU] key on the front panel. The menu screens enable you to configure the set point, the hysteresis high and low values, calibration value, and to select the location of the decimal point.

Set Points

The 660 unit offers two alarms; each alarm has a high and low set point. Each set point controls an alarm output and a front panel LED, and is defined by a Set Point High and a Set Point Low entry. Refer to *How To Configure Set Points*, page 54, for more information on entering the set point values. The default setting for both set point high entries is +11.000, and -11.000 for both set point low entries.

The 660 unit constantly compares the pressure reading to the value entered for each set point. Table 10 describes how the 660 unit responds to the pressure reading relative to the set point entries. If the pressure reading is *less than* the set point high value and *greater than* the set point low value, the alarms are not activated and the status LEDs will be off. If the pressure reading deviates from the range defined by the set points, the appropriate alarm is activated.

Action of the Set Point Values	
Pressure Value	Action of the 660 Unit
\geq Set point high value	Alarm is activated
Between the set point high and set point low values	Alarm is not activated
\leq Set point low value	Alarm is activated

Table 10: Action of the Set Point Values

Activated Alarms

If the pressure readout (magnitude plus sign) *equals or exceeds* the set point high value, the output associated with the set point will be *activated*, and the front panel status LED (H1 or H2) will be illuminated. Once the data exceeds the set point high value, the incoming data must drop below the set point high value minus the hysteresis high (HH) value, before the output is deactivated and the status LED is turned off.

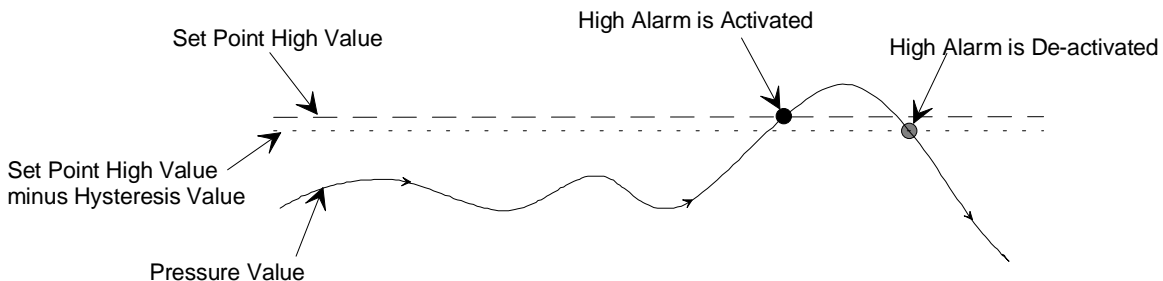

Figure 6: Action of the Set Point High Alarm

If the pressure readout (magnitude plus sign) *equals or drops below* the set point low value, the output associated with the set point will be *activated*, and the front panel status LED (L1 or L2) will be illuminated. Once the data drops below the set point low value, the incoming data must exceed the set point low value plus the hysteresis low (HL) value, before the output is deactivated and the status LED is turned off.

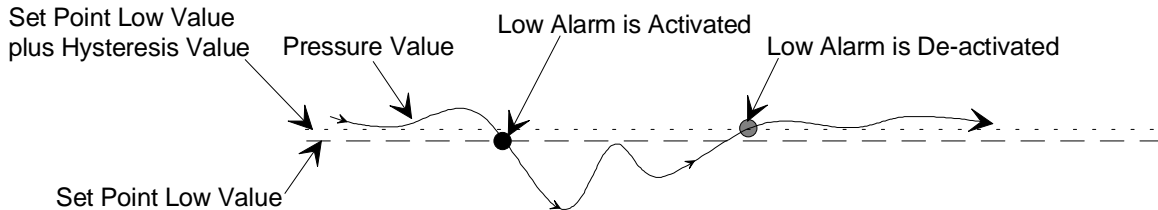

Figure 7: Action of the Set Point Low Alarm

These changes only occur when the pressure data *equals or exceeds* the set point high value, or, *equals or drops below* the set point low value.

Alarms

The 660 unit has four alarms; one alarm is associated with each set point. The alarm outputs are located on the I/O connector. Each alarm controls an open collector transistor. When an alarm is activated, the front panel LED is illuminated and the open collector transistor is turned on, bringing the signal to ground potential. Refer to *Connectors*, page 28, for detailed information on the connectors.

When an alarm is activated (turned on), the transistor is turned on and will sink ≤ 100 mA. In the deactivated state (turned off), the transistor is turned off and will block voltages ≤ 50 Volts.

Hysteresis

The hysteresis feature, built into the operation of the alarms, helps to compensate for the noise inherent in all systems. Excessive noise can cause the alarms to repeatedly switch states, a condition known as “relay chatter.” The amount of hysteresis can be adjusted separately for each alarm output.

Setting the hysteresis values too high will create a “deadband” around the set point. The deadband prevents the alarm output from responding to changes in the pressure signal around the set point. Ideally, the hysteresis should be close to, but not less than, the peak-to-peak noise. This setting will provide maximum immunity from chatter while providing the best possible response. The optimum hysteresis value will vary for each system.

The 660 unit offers a high and low hysteresis value. The 660 unit uses the hysteresis high (HH) value to determine the pressure reading that the system must obtain before the respective high outputs are deactivated and the status LEDs are turned off. The target pressure is determined by subtracting the number of counts defined by the hysteresis high value from the set point high pressure. The actual pressure reading must drop below the target pressure before the high alarms will be deactivated.

The 660 unit uses the hysteresis low (HL) value to determine the pressure reading that the system must obtain before the set point low alarm outputs are deactivated and the status LEDs are turned off. The target pressure is determined by adding the set point low pressure plus the number of counts defined by the hysteresis low value. The actual pressure reading must exceed the target pressure before the low alarms will be deactivated.

The hysteresis entries can range from 0 and 99, inclusive, with +00.020 set as the default.

How To Set the Hysteresis Value, page 55, discusses how to change the hysteresis entries.

The CAL Number

The CAL number allows you to calibrate the full scale reading in any engineering units. For example, if you are using a 1 Torr transducer, you could set the CAL number to 1000 to display the pressure in milliTorr. If you are using a flow meter with the 660 unit, use the CAL number to enter the gas correction factor.

Refer to *How To Calibrate the Full Scale Reading*, page 42, for more information.

Note



After you change the CAL number you **must** calibrate the full scale value before the 660 unit will implement the new CAL number. Even though the 660 unit *accepts* a new CAL number any time, it only *implements* the new CAL number once the full scale is calibrated.

Decimal Point Position

The 660 unit provides six positions for the decimal point. Choose from the following decimal point positions:

.XXXXX

X.XXXXX

XX.XXX

XXX.XX

XXXX.X

XXXXX (no decimal point).

The initial setting is XX.XXX. *How To Change the Decimal Point Position*, page 40, describes how to set this value.

Overrange Display

The 660 unit displays the pressure reading on the front panel display. The pressure is considered overrange if it is greater than 105% of full scale. If the pressure is overrange, the value flashes on and off on the front panel display. The actual overrange pressure value is dependent on the full scale calibration.

Refer to *How To Calibrate the Full Scale Reading*, page 42, for more information.

Labels

Note



Refer to *Safety Information*, page 1, for a description of any symbols which may be found on the unit.

Serial Number Label

The serial number label, affixed to the side of the unit, lists the model code of the unit and displays the CE mark indicating compliance with the European CE directives.



Figure 8: Serial Number Label

Information Labels

The rear panel of the 660 unit contains two information labels: one lists the power consumption, the second lists the fuse values. The power consumption label indicates the input voltage. Figure 4, page 28, shows the location of the labels on the rear panel.

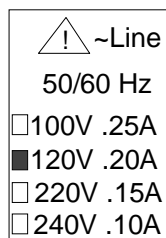

Figure 9: Power Consumption Information Label

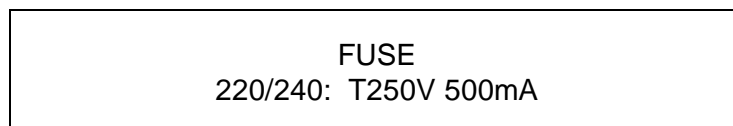

Figure 10: Fuse Information Label

Chapter Four: Operation

General Information

This chapter describes how to operate the 660 unit from the front panel. To operate the 660 unit remotely, refer to *Chapter Five: RS-232 Communications*, page 57.

How To Use the Menus

Pressing the [MENU] key, located on the front panel, cycles through all of the configuration screens, listed in Table 11. Refer to Figure 1, page 26, for a view of the front panel.

The [MENU] Key Selections			
Parameter Description	Parameter Abbreviation	Default Value	“How To Change” Page Number
Set Point High 1	SPH1	+11.000	54
Set Point Low 1	SPL1	-11.000	54
Set Point High 2	SPH2	+11.000	54
Set Point Low 2	SPL2	-11.000	54
Hysteresis High	HH	+00.020	55
Hysteresis Low	HL	+00.020	55
CAL Number	CAL	+10.000	42
Decimal Point	dP	xx.xxx	40

Table 11: The [MENU] Key Selections

As you scroll through the menu screens, the display initially shows the parameter abbreviation listed in Table 11, for several seconds before it lists the actual value of the entry. For example, when you press the [MENU] key once, the display shows “SPH1” for Set Point High 1. It holds this display for several seconds before it displays the actual value.

Note



Once the 660 unit begins to scroll through the menus, it must complete the cycle. Press the [MENU] key repeatedly to scroll through all of the screens.

Changing Entries

When the 660 unit displays the parameter value, one digit will blink. To accept the value, press the [MENU] key to advance to the next screen. To edit the value, use the up arrow [▲] key to change the value, and the right arrow [▶] key to select another digit. The [▲] key scrolls through the numbers 0 to 9, incrementing once for each key press.

Note



For the leftmost (first) digit *only*, the [▲] key scrolls through 0 to 9 and then -0 through -9. Watch the sign indicator to the left of the display meter. When the sign indicator light is off the sign is positive. The sign indicator light will flash with the left digit when the sign is negative.

The right arrow [▶] key moves the cursor to the right one position. When the entire value is correct, press the [MENU] key to accept the value and advance to the next screen.

How To Exit the Menu

To exit the menus and return to the normal display screen, you must scroll through all of the menu selections. As you scroll through the menus, the display screen will list the parameter abbreviation followed by the appropriate value. Once the menu cycle is complete, the display screen will show the pressure reading.

How To Change the Decimal Point Position

1. Repeatedly press the [MENU] key until the Decimal Point screen is displayed.

The system responds by displaying the Decimal Point abbreviation “dP” for several seconds before displaying the value.

2. Press the up arrow [▲] key to move the decimal point to the left.

The decimal point moves one place for each key press.

3. Press the [MENU] key to accept the value and exit from the configuration screens.

The system responds by accepting the new decimal point position.

How To Set the Zero Reading

1. Pump down the system to its base pressure.

In order to achieve a proper zero, the pressure of the system must be *lower* than the resolution of the Baratron pressure transducer used to measure system pressure.

2. Press the [ZERO] key for at least three seconds.

The unit responds by zeroing the display only; it does not zero the sensor or the 660 analog output signal.

Note

Pressing the [ZERO] key **does not** zero the sensor or the 660 analog output signal! Refer to the instruction manual of the sensor for directions on how to zero the sensor.

How To Use the Remote Zero

1. Pump down the system to its base pressure.

In order to achieve a proper zero, the pressure of the system must be *lower* than the resolution of the Baratron transducer used to measure system pressure.

2. Connect pin 10 (remote zero) to pin 5 (digital ground) on the I/O connector. Hold the connection for at least three seconds.

The unit responds by zeroing the display only; it does not zero the sensor or the 660 analog output signal. Refer to Table 7, page 30, for the pinout of the I/O connector.

Note

The remote zero function **does not** zero the sensor or the 660 analog output signal! Refer to the instruction manual of the sensor for directions on how to zero the sensor.

How To Calibrate the Full Scale Reading

Setting the full scale reading involves three distinct steps:

- calculating the CAL number
- positioning the decimal point
- calibrating the full scale voltage

These steps must be performed in the following sequence to *set the full scale reading* correctly. However, you can calibrate the full scale voltage or change the decimal point position independently, as long as the CAL number does not change.

The 660 unit uses these entries (CAL number, the full scale voltage setting, and the decimal point position) to determine the pressure reading displayed.

Calculating the CAL Number

The CAL number allows you to display the pressure reading, or flow rate, in the units of your choice. The 660 unit is shipped with the full scale voltage set to 10 Volts and the CAL number set to 10000.

Note



You must select the CAL number *before* performing the Full Scale calibration. Changing the CAL number has no effect until a Full Scale voltage calibration is performed.

The CAL number for pressure systems depends on the full scale range of your transducer and any engineering unit conversion factors necessary. *Appendix B, Engineering Unit Conversion Factors*, page 73, lists common conversion factors for pressure and flow units. To determine the CAL number for pressure systems, multiply the transducer full scale range by the engineering unit conversion factor:

$$\text{CAL Number} = (\text{Full Scale Range})(\text{Eng. Unit Conversion Factor})$$

For flow systems, the CAL number is equal to the product of three numbers: the flow meter full scale range; any engineering unit conversion factor; and the gas correction factor (GCF) for the particular gas:

$$\text{CAL Number} = (\text{Full Scale Range})(\text{Eng. Unit Conversion Factor})(\text{GCF})$$

Appendix D: Gas Correction Factors, page 75, lists the gas correction factors for commonly used gases. *Appendix B, Engineering Unit Conversion Factors*, page 73, lists common conversion factors for pressure and flow units.

Note  Depending on the range of your transducer or flow meter, you may need to truncate or add zeros to the CAL number to fill the five digits. The decimal point position has no significance in the CAL screen.

Caution  **Be sure that your system is configured to withstand the full scale pressure *before* proceeding. Otherwise, your system may be damaged.**

1. Press the [MENU] key several times to scroll to the CAL Number screen.

The system responds by displaying the abbreviation “CAL” for several seconds before displaying the value. The default value is +10000.

Note  The decimal point has no meaning in the CAL screen. The decimal point will appear in the location set by the decimal point position entry. Simply ignore the decimal point when entering the CAL number.

2. Verify that the CAL number is correct for your full scale voltage.

If it is correct, proceed to step 7. If the CAL number is incorrect, complete steps 3 through 6 to enter the appropriate CAL number. The following examples list common CAL number settings.

3. Use the [▲] key to set the first digit value.

The system responds by scrolling through the numbers 0 to 9, incrementing one number for each key press. The CAL number can range from 1 to 99,999 counts.

Note  The actual converter has 20,000 counts of resolution. Therefore, the resolution that can be displayed by the meter is equal to the CAL number divided by 20,000.

4. Use the right arrow [▶] key to move the cursor one position to the right.

The second digit will flash, to indicate that its value can be changed.

5. Repeat steps 3 and 4 to edit the remaining digits.

6. Press the [MENU] key to accept the value and advance to the Decimal Point screen.

The system responds by accepting the new CAL number.

7. Press the [MENU] key repeatedly to exit the menus and return to the display screen.

The system responds by exiting the menus and displaying the pressure reading.

Positioning the Decimal Point

1. From the CAL Number screen, press the [MENU] key once to display the Decimal Point screen. From any other screen, repeatedly press the [MENU] key until the Decimal Point screen is displayed.

The system responds by displaying the Decimal Point abbreviation “dP” for several seconds before displaying the value.

2. Press the [▲] key to move the decimal point to the left.

The decimal point moves one place for each key press.

3. Press the [MENU] key to accept the value and exit from the configuration screens.

The system responds by accepting the new decimal point position.

Calibrating the Full Scale Voltage

1. Connect a precision voltage source to the 660 unit and input the voltage equal to the transducer or flow meter full scale.

This output must exceed 1 Volt.

2. Press the [FULL SCALE] key for at least three seconds to turn off the full scale calibration.

The system responds by turning off the FS CAL LED on the side bar and changing the display from a scaled pressure reading to raw converter counts.

3. Press the [FULL SCALE] key for at least three seconds.

The FS CAL LED will illuminate and the display will show the FS CAL value as a scaled pressure reading.

The following examples calculate the CAL number for various configurations.

Example 1: 100 Torr Transducer with Pressure Expressed in Torr

This example assumes that your transducer is connected to the 660 unit and you are using the following equipment:

Transducer	100 Torr Type 627A pressure transducer (or any other 100 Torr transducer)
Full Scale Range/Calibration	100 Torr
Full Scale Output	10 Volt output
Display Reading in	Torr
Engineering Units Conversion Factor	1.0

1. Press the [MENU] key several times to scroll to the CAL Number screen.
The system responds by displaying “CAL” briefly before displaying the CAL number.

2. The CAL number should be 10000 (100 x 1.0 plus two additional zeros to fill the five digits).

The CAL number is set to 10000 when it leaves the factory, so you may not need to change the entry. Refer to steps 3 through 6, page 43, for detailed instructions on how to change the CAL number, if necessary. This number will represent the full scale voltage value.

Note

The decimal point has no meaning in the CAL screen. The decimal point will appear in the location set by the decimal point position entry. Simply ignore the decimal point when entering the CAL number.

3. Press the [MENU] key to accept the value and advance to the Decimal Point screen.
The system responds by accepting the new CAL number.
4. Use the arrow keys [▲] and [▶] to set the decimal point to the XXX.XX position.
Refer to *How To Change the Decimal Point Position*, page 40, for detailed instructions on how to perform this step.
5. Press the [MENU] key repeatedly to exit the menus and return to the display screen.
The system responds by exiting the menus and displaying the pressure reading.
6. Connect a precision voltage source to the 660 unit and input the voltage equal to the transducer full scale.

7. Press the [FULL SCALE] key until the FS CAL status LED is no longer illuminated, approximately three seconds, to turn off the full scale calibration.

The system responds by turning off the FS CAL LED on the side bar and changing the display from a scaled pressure reading to raw converter counts.

8. Press the [FULL SCALE] key for at least three seconds.

The FS CAL LED will illuminate and the display will show the FS CAL value as a scaled pressure reading.

The system is now calibrated to display the pressure reading in Torr, with a full scale reading of 100 Torr.

Example 2: 2 Torr Transducer with Pressure Expressed in Torr

This example assumes that your transducer is connected to the 660 unit and you are using the following equipment:

Transducer	2 Torr Type 627A pressure transducer (or any other 2 Torr transducer)
Full Scale Range	2 Torr
Full Scale Output	10 Volt output
Display Reading in	Torr
Engineering Units Conversion Factor	1.0

1. Press the [MENU] key several times to scroll to the CAL Number screen.

The system responds by displaying “CAL” briefly before displaying the CAL number.

2. Use the arrow keys [▲] and [▶] to set the CAL number to 20000 (20000 x 1.0).

This number will represent the full scale voltage value.

Note



The decimal point has no meaning in the CAL screen. The decimal point will appear in the location set by the decimal point position entry. Simply ignore the decimal point when entering the CAL number.

Refer to steps 3 through 6, page 43, for detailed instructions on how to change the CAL number. The default value is 10000.

3. Press the [MENU] key to accept the value and advance to the Decimal Point screen.

The system responds by accepting the new CAL number.

4. Use the arrow keys [▲] and [▶] to set the decimal point to the X.XXXXX position.
Refer to *How To Change the Decimal Point Position*, page 40, for detailed instructions on how to perform this step.
5. Press the [MENU] key repeatedly to exit the menus and return to the display screen.
The system responds by exiting the menus and displaying the pressure reading.
6. Connect a precision voltage source to the 660 unit and input the voltage equal to the transducer full scale.
7. Press the [FULL SCALE] key until the FS CAL status LED is no longer illuminated, approximately three seconds, to turn off the full scale calibration.
The system responds by turning off the FS CAL LED on the side bar and changing the display from a scaled pressure reading to raw converter counts.
8. Press the [FULL SCALE] key again until the FS CAL status LED is lit.
The FS CAL LED will illuminate and the display will show the FS CAL value as a scaled pressure reading.
The system is now calibrated to display the pressure reading in Torr with a full scale reading of 2 Torr.

Example 3: 100 Torr Transducer with Pressure Expressed in Pascal

This example assumes that your transducer is connected to the 660 unit and you are using the following equipment:

Transducer	100 Torr Type 627A pressure transducer (or any other 100 Torr transducer)
Full Scale Range	100 Torr
Full Scale Output	10 Volt output
Display Reading in	Pascal
Engineering Units Conversion Factor	133.32

1. Press the [MENU] key several times to scroll to the CAL Number screen.
The system responds by displaying “CAL” briefly before displaying the CAL number.
2. Use the arrow keys [▲] and [▶] to set the CAL number to 13332 (100 x 133.32).
The conversion factor to convert from Torr to Pascal is 133.32.

Note

The decimal point has no meaning in the CAL screen. The decimal point will appear in the location set by the decimal point position entry. Simply ignore the decimal point when entering the CAL number.

Refer to steps 3 through 6, page 43, for detailed instructions on how to change the CAL number. The default value is 10000.

3. Press the [MENU] key to accept the value and advance to the Decimal Point screen.
The system responds by accepting the new CAL number.
4. Use the arrow keys [▲] and [▶] to set the decimal point to the XXXXX position.
Refer to *How To Change the Decimal Point Position*, page 40, for detailed instructions on how to perform this step.
5. Press the [MENU] key repeatedly to exit the menus and return to the display screen.
The system responds by exiting the menus and displaying the pressure reading.
6. Connect a precision voltage source to the 660 unit and input the voltage equal to the transducer full scale.

7. Press the [FULL SCALE] key until the FS CAL status LED is no longer illuminated, approximately three seconds, to turn off the full scale calibration.

The system responds by turning off the FS CAL LED on the side bar and changing the display from a scaled pressure reading to raw converter counts.

8. Press the [FULL SCALE] key again until the FS CAL status LED is lit.

The FS CAL LED will illuminate and the display will show the FS CAL value as a scaled pressure reading.

The system is now calibrated to display the pressure reading in Pascal with a full scale reading of 13,332 Pascal.

Example 4: 5000 sccm MFC with Flow Expressed in sccm

This example assumes that you have a flow meter calibrated for nitrogen, and your process requires argon gas. The flow meter is connected to the 660 unit and you are using the following equipment:

Flow Meter	1159 Mass Flow Controller (or any other MFC)
Full Scale Range	5000 sccm (Nitrogen calibrated)
Full Scale Output	5 Volt output
Display Reading in	sccm
Engineering Units Conversion Factor	1.0
Gas Correction Factor	1.39 for Argon

1. Press the [MENU] key several times to scroll to the CAL Number screen.
The system responds by displaying “CAL” briefly before displaying the CAL number.
2. Use the arrow keys [▲] and [▶] to set the CAL number to 69500 (5000 x 1.39 plus one additional zero to fill the five digits).
This is the flow rate equivalent to the full scale voltage value.

Note

The decimal point has no meaning in the CAL screen. The decimal point will appear in the location set by the decimal point position entry. Simply ignore the decimal point when entering the CAL number.

Refer to steps 3 through 6, page 43, for detailed instructions on how to change the CAL number. The default value is 10000.

3. Press the [MENU] key to accept the value and advance to the Decimal Point screen.
The system responds by accepting the new CAL number.
4. Use the arrow keys [▲] and [▶] to set the decimal point to the XXXX.X position.
Refer to *How To Change the Decimal Point Position*, page 40, for detailed instructions on how to perform this step.
5. Press the [MENU] key repeatedly to exit the menus and return to the display screen.
The system responds by exiting the menus and displaying the flow reading.

6. Connect a precision voltage source to the 660 unit and input the voltage equal to the flow meter full scale.

The flow meter full scale output is 5 Volts.

7. Press the [FULL SCALE] key until the FS CAL status LED is no longer illuminated, approximately three seconds, to turn off the full scale calibration.

The system responds by turning off the FS CAL LED on the side bar and changing the display from a scaled pressure reading to raw converter counts.

8. Press the [FULL SCALE] key again until the FS CAL status LED is lit.

The FS CAL LED will illuminate and the display will show the FS CAL value as a scaled flow rate.

The system is now calibrated to display the flow reading in sccm with a full scale reading of 6950 sccm.

Example 5: 30,000 sccm MFC with Flow Expressed in slm

This example assumes that you have a flow meter calibrated for nitrogen, and your process requires argon gas. The flow meter is connected to the 660 unit and you are using the following equipment:

Flow Meter	1159 Mass Flow Controller (or any other MFC)
Full Scale Range	30,000 sccm (Nitrogen calibrated)
Full Scale Output	5 Volt output
Display Reading in	slm
Engineering Units Conversion Factor	0.001
Gas Correction Factor	1.39 for Argon

1. Press the [MENU] key several times to scroll to the CAL Number screen.

The system responds by displaying “CAL” briefly before displaying the CAL number.

2. Use the arrow keys [▲] and [▶] to set the CAL number to 41700 (30000 x 1.39 x 0.001 plus two additional zeros to fill the five digits).

This is the flow rate equivalent to the full scale voltage value.

Note

The decimal point has no meaning in the CAL screen. The decimal point will appear in the location set by the decimal point position entry. Simply ignore the decimal point when entering the CAL number.

Refer to steps 3 through 6, page 43, for detailed instructions on how to change the CAL number. The default value is 10000.

3. Press the [MENU] key to accept the value and advance to the Decimal Point screen.

The system responds by accepting the new CAL number.

4. Use the arrow keys [▲] and [▶] to set the decimal point to the XX.XXX position.

Refer to *How To Change the Decimal Point Position*, page 40, for detailed instructions on how to perform this step.

5. Press the [MENU] key repeatedly to exit the menus and return to the display screen.

The system responds by exiting the menus and displaying the flow reading.

6. Configure the system to produce a full scale output from the flow meter.

The flow meter full scale output is 5 Volts.

7. Press the [FULL SCALE] key until the FS CAL status LED is no longer illuminated.

The system responds by turning off the FS CAL LED on the side bar and changing the display from a scaled pressure reading to raw converter counts.

8. Press the [FULL SCALE] key again until the FS CAL status LED is lit.

The FS CAL LED will illuminate and the display will show the FS CAL value as a scaled flow rate.

The system is now calibrated to display the flow reading in slm with a full scale reading of 41.7 slm.

How To Configure the Set Points

1. Press the [MENU] key once to set the Set Point High 1 value.

The system responds by displaying the Set Point High 1 abbreviation, “SPH1” briefly, and then the parameter value. The default value is +11.000.

2. Use the [▲] key to set the first digit value.

The system responds by scrolling through the numbers 0 to 9, incrementing one number for each key press.

Note

For the left most (first) digit *only*, the [▲] key scrolls through 0 to 9 and then -0 through -9. Watch the sign indicator to the left of the display meter. When the sign indicator light is off the sign is positive. The sign indicator light will flash with the left digit when the sign is negative.

3. Use the right arrow [▶] key to move the cursor to the right one position.

The second digit will flash, to indicate that its value can be changed.

4. Repeat steps 2 and 3 to edit the remaining digits.

5. Press the [MENU] key to accept the value and advance to the Set Point Low 1 screen.

The system responds by displaying the Set Point Low 1 abbreviation, “SPL1” briefly, and then the parameter value. The default value is -11.000.

6. Repeat steps 2 and 3 to change the value of SPL1. Press the [MENU] key if you do not need to edit SPL1.

7. Select the Set Point High 2 value, following steps 2 and 3, above.

The system responds by displaying the Set Point High 2 abbreviation, “SPH2” briefly, and then the parameter value. The default value is +11.000.

8. Press the [MENU] key once again to set the Set Point Low 2 value.

The system responds by displaying the Set Point Low 2 abbreviation, “SPL2” briefly, and then the parameter value. The default value is -11.000.

9. Repeatedly press the [MENU] key to scroll through the menus and return to the pressure display screen.

How To Deactivate An Alarm

Any of the four alarms (two high and two low) can be deactivated.

- To deactivate a *high* alarm, set the set point value greater than positive full scale.
- To deactivate a *low* alarm, set the set point value less than negative full scale.

Both alarms are deactivated when the 660 unit is shipped from the factory.

How To Set the Hysteresis Value

For an explanation of hysteresis, refer to *Hysteresis*, page 36.

1. Repeatedly press the [MENU] key until the Hysteresis High screen is displayed.
The system responds by displaying the Hysteresis High abbreviation “HH” for several seconds before displaying the value.
2. Use the [▲] key to set the first digit value.
The system responds by scrolling through the numbers 0 to 9, incrementing one number for each key press.

Note

The maximum setting for the hysteresis value is 99. The default value is 0.020.

3. Use the right arrow [▶] key to move the cursor to the right one position.
The second digit will flash, to indicate that its value can be changed.
4. Repeat steps 2 and 3 to edit the remaining digits.
5. Press the [MENU] key to accept the value and advance to the Hysteresis Low screen.
The system responds by displaying the Hysteresis Low abbreviation, “HL” briefly, and then the parameter value. The default value is +00.020.
6. Repeatedly press the [MENU] key to scroll through the menus and return to the pressure display screen.

This page intentionally left blank.

Chapter Five: RS-232 Communications

General Information

The 660 unit supports RS-232 communications using the I/O connector, located on the rear panel. (Refer to Table 7, page 30, for the complete pinout). The interface for RS-232, or serial, communication uses a three wire configuration without handshaking. The connections are:

RS-232 Pin Assignments on the I/O Connector	
Pin Number	Assignment
1	Transmit (TXD)
2	Receive (RXD)
5	Digital Ground

Table 12: RS-232 Pin Assignments on the I/O Connector

Cabling

The 660 unit is configured as a DTE (Data Terminal Equipment) device. Therefore, to send and receive information, you must ensure that the transmit and receive lines are connected properly.

- Connect the transmit line on the 660 unit (pin 1) to the receive line on your computer
- Connect the receive line on the 660 unit (pin 2) to the transmit line on your computer

Figure 11 shows the standard pin assignments for a 9-pin and 25-pin RS-232 connector.

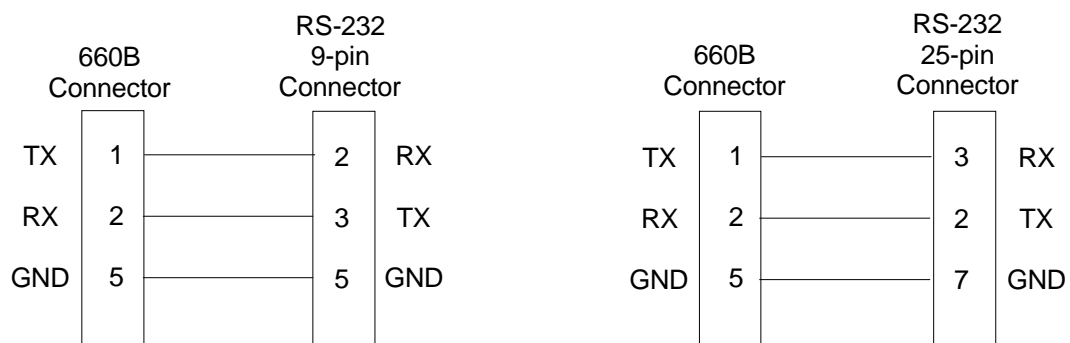

Figure 11: Cabling Connections for RS-232 Communication

RS-232 Communication Parameters

The initial settings for all communication parameters are listed in Table 13. The baud rate and parity parameters are selectable through switches located beneath the conductive hole plug on the side of the 660 unit.

RS-232 Communication Parameters		
Parameter	Initial Setting	Options
Baud Rate	9600	2400
Parity	None	Even
Data Bits*	8*	7*
Stop Bit**	1**	No Option
End-of-Line Delimiter**	Carriage Return Line Feed (CR-LF)**	No Option
<p>* The data bits are linked to the parity; either Even and 7 bits or None and 8 bits. ** The parameter value is fixed, you cannot change it.</p>		

Table 13: RS-232 Communication Parameters

How To Change the RS-232 Communication Parameters

Note



The 660 unit reads the dipswitch settings at power up only. Therefore, you must reboot the unit after changing the communication parameters.

1. Locate the conductive hole plug on the side of the 660 unit.

With the front panel of the 660 unit facing you, the access hole is on the righthand side of the unit, as shown in Figure 2, page 26.

2. Insert a flat object, such as a flat head screw driver, under the conductive hole plug and carefully lift off the plug. Once the plug is removed, the dipswitch bank will be visible, as shown in Figure 12, page 59.

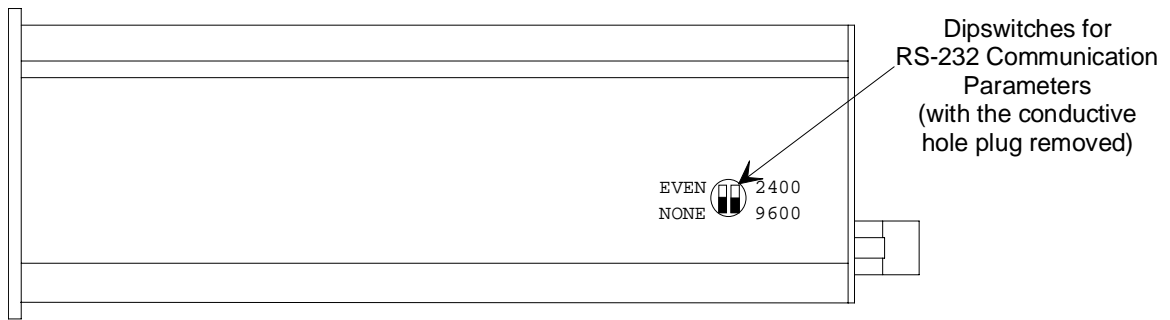

Figure 12: Location of the Switches for RS-232 Communication

- Use a small screw driver to change the necessary dipswitch settings according to the information in Tables 14 and 15.

The dipswitch settings are labeled on the side of the unit.

Baud Rate Settings	
Baud Rate	Dipswitch Setting
2400	Up
9600	Down

Table 14: Baud Rate Settings

Parity Settings	
Parity (and Data Bits)	Dipswitch Setting
Even (7 Data Bits)	Up
None (8 Data Bits)	Down

Table 15: Parity Settings

Note

The number of stop bits is set to 1 and the end-of-line delimiter is a carriage return line feed (CRLF). You *cannot* change either of these settings.

- Replace the conductive hole plug.
- After changing either switch setting, turn the power “Off” and then “On” again, for the change to take effect.

RS-232 Protocol

RS-232 messages used by the 660 unit are composed of a variable length ASCII string and end with a carriage return line feed <CRLF>. Use your communications software on the computer to assign a CRLF to the  key.

Messages sent to the 660 unit from a remote computer, are either *commands* that instruct the instrument to change or set an operating parameter, or *requests* that prompt the instrument to report information. Messages sent by the 660 unit to the remote computer, are *responses*. Responses are the reply to a request sent by the remote computer.

Note



The RS-232 protocol is not case sensitive, therefore, you may enter messages in either upper- or lowercase text.

Message Syntax

The information presented in this section applies to all RS-232 messages. The RS-232 message syntax uses the following conventions:

bold	Messages that you must enter exactly as shown in the manual. Do not include any spaces in the message string. Include the exact number of characters for each message.
<i>italics</i>	Placeholder that represents text or numeric values that you must supply.
response	Format of message sent from the 660 unit.
	Represents Carriage Return Line Feed that must be configured as the end-of-line delimiter (in your communications software).

Errors

The 660 unit will not send an error message to indicate that it received an incorrect message. Instead, the unit may simply ignore the message or it may enter erroneous data. Therefore, you should issue a request after every command to ensure that the command was accepted and implemented.

Serial Lockout

The 660 unit will not respond to RS-232 messages while it is in the menu or calibration modes. Any RS-232 messages received during this time will be ignored.

RS-232 Messages

Refer to *Chapter Three: Overview*, page 33, for a complete description of each function of the 660 unit.

Note



You must enter each message *exactly* the way it appears in the following tables. Be sure to enter the correct number of characters in each message.

A command message formatted incorrectly may cause incorrect data to be entered. A request message formatted incorrectly may fail to report data or it may report data on a different parameter.

Command Messages

Note



The 660 unit will not send a response when it receives a command. You should issue a request message after each command message to ensure that the command was accepted and implemented.

RS-232 Command Messages		
Description	Command	Additional Information
Zero	Z ^{ENTER}	Make sure that the pressure reading is at an appropriate zero level. <i>This command sets the display to zero; it does not zero the sensor.</i> Refer to the sensor instruction manual for directions on how to zero the sensor.
Full Scale	F ^{ENTER}	The displayed pressure must exceed 1000 counts. As a safety precaution, this command must be sent <i>twice</i> before the 660 will recalibrate the full scale value. Wait at least 500 milliseconds between commands.
CAL Number	SXXXXX ^{ENTER}	The XXXXX represents a number between 00000 and 99999. All five characters must be sent. Do <i>not</i> send a polarity sign (+ or -).

Table 16: RS-232 Command Messages
(Continued on next page)

RS-232 Command Messages (Continued)		
Description	Command	Additional Information
Decimal Point Position	D X ^{ENTER}	where X = 1 for X.XXXX X = 2 for XX.XXX X = 3 for XXX.XX X = 4 for XXXX.X X = 5 for XXXXX (no decimal point)
Set Point 1 High Value	P1 pXXXXX ^{ENTER}	where p = polarity (+ or -) <i>Sign must be included.</i> XXXXX = a number between 00000 and 99999. All six characters (polarity plus five numbers) must be sent.
Set Point 1 Low Value	P2 pXXXXX ^{ENTER}	where p = polarity (+ or -) <i>Sign must be included.</i> XXXXX = a number between 00000 and 99999. All six characters (polarity plus five numbers) must be sent.
Set Point 2 High Value	P3 pXXXXX ^{ENTER}	where p = polarity (+ or -) <i>Sign must be included.</i> XXXXX = a number between 00000 and 99999. All six characters (polarity plus five numbers) must be sent.
Set Point 2 Low Value	P4 pXXXXX ^{ENTER}	where p = polarity (+ or -) <i>Sign must be included.</i> XXXXX = a number between 00000 and 99999. All six characters (polarity plus five numbers) must be sent.
Hysteresis High	H1 XX ^{ENTER}	where XX = a number between 00 and 99 Do not send a polarity sign (+ or -).
Hysteresis Low	H2 XX ^{ENTER}	where XX = a number between 00 and 99 Do not send a polarity sign (+ or -).

Table 16: RS-232 Command Messages

Request Messages

The 660 unit reports a value in response to a request message. The request messages and their responses are listed in Table 17.

RS-232 Request Messages			
Request to Report	Request	Response	Additional Information
Pressure Reading	R5 <input type="button" value="ENTER"/>	Pvalue	where <i>value</i> is a five digit number The decimal point is set with the “D” command. This message reports the zeroed display reading not the analog pressure output value . The display reading is changed by the remote zero function, whereas, the analog pressure output signal is not.
Full Scale Reading	R8 <input type="button" value="ENTER"/>	Svalue	where <i>value</i> is a five digit number
Current Decimal Point Position	R9 <input type="button" value="ENTER"/>	DX	where $x = 1$ for X.XXXXX = 2 for XX.XXX = 3 for XXX.XX = 4 for XXXX.X = 5 for XXXXX (no decimal displayed)
Set Point 1 High Value	R1 <input type="button" value="ENTER"/>	P1value	where <i>value</i> is between 00000 and 99999
Set Point 1 Low Value	R2 <input type="button" value="ENTER"/>	P2value	where <i>value</i> is between 00000 and 99999
Set Point 2 High Value	R3 <input type="button" value="ENTER"/>	P3value	where <i>value</i> is between 00000 and 99999
Set Point 2 Low Value	R4 <input type="button" value="ENTER"/>	P4value	where <i>value</i> is between 00000 and 99999
Hysteresis High	R6 <input type="button" value="ENTER"/>	H1xx	where <i>xx</i> is 00 to 99
Hysteresis Low	R7 <input type="button" value="ENTER"/>	H2xx	where <i>xx</i> is 00 to 99

Table 17: RS-232 Request Messages

This page intentionally left blank.

Chapter Six: Maintenance

General Information

Periodically check for wear on the cables and inspect the enclosure for visible signs of damage.

How To Clean the Unit

Periodically wipe down the unit with a damp cloth

How To Replace the Fuses

1. Select the proper fuse. The 660 unit uses a 500 mA Time-Lag fuse.

These fuses are available from MKS and several other suppliers. Table 18 lists the supplier and the part number for the correct fuse.

Fuse Information	
Supplier	Part Number
MKS	024-5834
Bussmann	GDC-500mA
Schurter	034-3114
Bel Fuse	5ST500

Table 18: Fuse Information

2. Disconnect the power cord from the 660 unit.

Warning



To avoid an electrical shock, be sure to disconnect the power cord *before* proceeding.

3. Insert a small device, for example, a screwdriver, in the fuse holder clip on the right side of the fuse holder.

Refer to Figure 4, page 28, for the location of the fuse holder.

4. Gently slide out the plastic fuse holder.
5. Replace the old fuse with new one and gently snap the fuse holder back into place.

All units should have two fuses: the innermost fuse actually fuses the line, the outermost fuse is a spare.

6. Connect the power cord.

Appendix A: Product Specifications

Performance Specifications

Accuracy	$\pm 0.01\%$ of reading ± 1 digit ¹
Alarms	Two high alarms, two low alarms. Each alarm has an open collector transistor located on the I/O connector.
Transistor Ratings	
Maximum Collector Voltage	50 Volts
Maximum Collector Current	100 mA
V _{ce} (sat)	< 0.4 Volts @ I _C = 10 mA
High alarms	Activated when the input pressure signal equals, or exceeds, the high trip point level.
Low alarms	Activated when the input pressure signal equals, or falls below, the low trip point level.
Action	Between the high and low trip points, no alarms are activated. Activated alarms will turn ON, the front panel LED will light, and the unit will bring the appropriate output transistor to ground potential.
CE Compliance	
Electromagnetic Compatibility ²	EMC Directive 89/336/EEC
Low-Voltage Requirements	Low-Voltage Directive 73/23/EEC
Installation Category	II, according to EN 61010-1
Pollution Degree	2, according to IEC 664
Product Safety Requirements	Product Safety Directive 92/59/EEC
Linearity	$\pm 0.01\%$ of Reading ± 1 digit
Resolution	$\pm 19,999$ counts
Sampling Rate	2 samples per second (2 Hz)
Zero Stability	1 μ V/ $^{\circ}$ C

¹For 120 days @ +25 $^{\circ}$ C \pm 2 $^{\circ}$ C

² An overall metal braided shielded cable, properly grounded at both ends, is required during use.

Electrical Specifications

Fuse Information	500 mA Time Lag fuse (MKS part number 024-5834)
Input Bias Current	< 1 nA
Input Impedance	> 200K ohm
Input Power Range	
660A1	108 to 132 VAC @50/60 Hz
660A2	216 to 264 VAC @ 50/60 Hz
660A3	90 to 110 VAC @ 50/60 Hz
660A4	198 to 242 VAC @ 50/60 Hz
Input Signal Range	0 to ± 10 VDC
Maximum Input Voltage	150 V P-P
Output Power	
Voltage	± 15 VDC $\pm 5\%$
Current	250 mA minimum (short circuit protected)
Power Consumption, 50/60 Hz	
100 V	0.25 A
120 V	0.20 A
220 V	0.15 A
240 V	0.10 A

Physical Specifications

Connectors	
Transducer	15-pin female Type “D”
I/O	15-pin female High Density Type “D”
Power	IEC international compliant
Dimensions	3.78” W x 1.89” H x 5.5” L (96 mm W x 48 mm H x 140 mm L) <i>(length does not include power cord and connector length)</i>
Display	0.4” high efficiency red LEDs
Maximum Display	± 99999
Decimal Point	Selectable from the front panel: .XXXXXX, X.XXXXX, XX.XXX, XXX.XX, XXXX.X, XXXXX (no decimal point).
Overrange	±105% of full scale input — normal pressure display >105% of full scale — display flashes overrange value (actual value is dependent on full scale range)
No sensor connected	Display flashes
Polarity	Minus sign displayed for negative readings. No sign for positive readings.
Operating Temperature Range	0° to 55° C (32° to 131° F)
Packaging	1/8 DIN case

RS-232 (Option) Specifications

Baud Rate	Selectable: 2400, 9600*
End-of-Line Delimiter	Carriage Return Line Feed (CRLF)
Parity and Data Bits	Selectable: Even and 7 Data Bits; None and 8 Data Bits*
Stop Bits	1
<i>* Initial Setting</i>	

Due to continuing research and development activities, these product specifications are subject to change without notice.

This page intentionally left blank.

Appendix B: Model Code Explanation

Model Code

The options of your transducer are identified in the model code when you order the unit.

The model code is identified as follows:

660BXY

where:

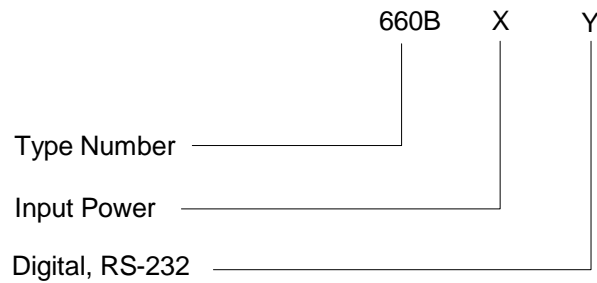

Type Number (660B)

This designates the model number of the instrument.

Input Power (X)

The input power is indicated by a single digit code.

Input Power (Nominal, 50/60 Hz)

120 V
240 V
100 V
220 V

Ordering Code

1
2
3
4

Digital, RS-232 Communication (Y)

The RS-232 digital communication option is indicated by a single digit code.

Option	Ordering Code
None	0
RS-232	2

Appendix C: Engineering Unit Conversion Factors

Pressure Units

Existing Pressure Unit	New Pressure Unit							
	Pa (Nm ⁻²)	mmHg (Torr) at 0°C	inHg at 0°C	mbar	psi	cmH ₂ O at 4°C	inH ₂ O at 4°C	Std atm
Pa (Nm ⁻²)	1	7.50062 x 10 ⁻³	2.95300 x 10 ⁻⁴	*0.01	1.45038 x 10 ⁻⁴	1.01974 x 10 ⁻²	4.01474 x 10 ⁻³	9.86923 x 10 ⁻⁶
mmHg (Torr)	133.322	1	3.93701 x 10 ⁻²	1.33322	1.93368 x 10 ⁻²	1.35955	5.35254 x 10 ⁻¹	1.31579 x 10 ⁻³
inHg	3386.38	*25.4	1	33.8638	4.91154 x 10 ⁻¹	34.5325	13.5955	3.34210 x 10 ⁻²
mbar	*100	0.750062	2.95300 x 10 ⁻²	1	1.4503 x 10 ⁻²	1.01974	4.01474 x 10 ⁻¹	9.86923 x 10 ⁻⁴
psi	6894.76	51.7149	2.03602	68.9476	1	70.3089	27.6807	6.80460 x 10 ⁻²
cmH ₂ O (at 4°C)	98.0638	0.735539	2.89583 x 10 ⁻²	9.80638 x 10 ⁻¹	1.42230 x 10 ⁻²	1	3.93701 x 10 ⁻¹	9.67814 x 10 ⁻⁴
inH ₂ O (at 4°C)	249.082	1.86827	7.35539 x 10 ⁻²	2.49082	3.61263 x 10 ⁻²	*2.54	1	2.45825 x 10 ⁻³
std atm	*101,325	*760	29.9213	*1013.25	14.6959	1033.26	406.794	1
kg/cm ²	*98,066.5	7.35559	28.9591	*980.665	14.2233	1000.03	393.712	9.67841 x 10 ⁻¹
	<i>*Exact value</i>							

Mass Flow Units

Existing Flow Unit	New Flow Unit			
	1 Torr liter sec ⁻¹	1 micron liter sec ⁻¹	1 atm cm ³ sec ⁻¹	1 std. ft ³ min ⁻¹
std. cm ³ min ⁻¹	78.95	0.07895	60	28317

This page intentionally left blank.

Appendix D: Gas Correction Factors

Gas Correction Factor for Pure Gases

Gas Correction Factor for Pure Gases				
GAS	SYMBOL	SPECIFIC HEAT, Cp cal/g ⁰ C	DENSITY g/l @ 0 ⁰ C	CONVERSION FACTOR
Air	---	0.240	1.293	1.00
Ammonia	NH ₃	0.492	0.760	0.73
Argon	Ar	0.1244	1.782	1.39 ¹
Arsine	AsH ₃	0.1167	3.478	0.67
Boron Trichloride	BCl ₃	0.1279	5.227	0.41
Bromine	Br ₂	0.0539	7.130	0.81
Carbon Dioxide	CO ₂	0.2016	1.964	0.70 ¹
Carbon Monoxide	CO	0.2488	1.250	1.00
Carbon Tetrachloride	CCl ₄	0.1655	6.86	0.31
Carbon Tetrafluoride (Freon - 14)	CF ₄	0.1654	3.926	0.42
Chlorine	Cl ₂	0.1144	3.163	0.86
Chlorodifluoromethane (Freon - 22)	CHClF ₂	0.1544	3.858	0.46
Chloropentafluoroethane (Freon - 115)	C ₂ ClF ₅	0.164	6.892	0.24
Chlorotrifluoromethane (Freon - 13)	CClF ₃	0.153	4.660	0.38
Cyanogen	C ₂ N ₂	0.2613	2.322	0.61
Deuterium	D ₂	1.722	0.1799	1.00
Diborane	B ₂ H ₆	0.508	1.235	0.44
Dibromodifluoromethane	CBr ₂ F ₂	0.15	9.362	0.19
Dichlorodifluoromethane (Freon - 12)	CCl ₂ F ₂	0.1432	5.395	0.35
Dichlorofluoromethane (Freon - 21)	CHCl ₂ F	0.140	4.592	0.42
Dichloromethylsilane	(CH ₃) ₂ SiCl ₂	0.1882	5.758	0.25

(Continued on next page)

Gas Correction Factor for Pure Gases (Continued)				
GAS	SYMBOL	SPECIFIC HEAT, Cp cal/g°C	DENSITY g/l @ 0°C	CONVERSION FACTOR
Dichlorosilane	SiH ₂ Cl ₂	0.150	4.506	0.40
1,2-Dichlorotetrafluoroethane (Freon - 114)	C ₂ Cl ₂ F ₄	0.160	7.626	0.22
1,1-Difluoroethylene (Freon - 1132A)	C ₂ H ₂ F ₂	0.224	2.857	0.43
2,2-Dimethylpropane	C ₅ H ₁₂	0.3914	3.219	0.22
Ethane	C ₂ H ₆	0.4097	1.342	0.50
Fluorine	F ₂	0.1873	1.695	0.98
Fluoroform (Freon - 23)	CHF ₃	0.176	3.127	0.50
Freon - 11	CCl ₃ F	0.1357	6.129	0.33
Freon - 12	CCl ₂ F ₂	0.1432	5.395	0.35
Freon - 13	CClF ₃	0.153	4.660	0.38
Freon - 13 B1	CBrF ₃	0.1113	6.644	0.37
Freon - 14	CF ₄	0.1654	3.926	0.42
Freon - 21	CHCl ₂ F	0.140	4.592	0.42
Freon - 22	CHClF ₂	0.1544	3.858	0.46
Freon - 23	CHF ₃	0.176	3.127	0.50
Freon - 113	C ₂ Cl ₃ F ₃	0.161	8.360	0.20
Freon - 114	C ₂ Cl ₂ F ₄	0.160	7.626	0.22
Freon - 115	C ₂ ClF ₅	0.164	6.892	0.24
Freon - 116	C ₂ F ₆	0.1843	6.157	0.24
Freon - C318	C ₄ F ₈	0.1866	8.93	0.164
Freon - 1132A	C ₂ H ₂ F ₂	0.224	2.857	0.43
Helium	He	1.241	0.1786	---2
Hexafluoroethane (Freon - 116)	C ₂ F ₆	0.1843	6.157	0.24
Hydrogen	H ₂	3.419	0.0899	---2
Hydrogen Bromide	HBr	0.0861	3.610	1.00

(Continued on next page)

Gas Correction Factor for Pure Gases (Continued)				
GAS	SYMBOL	SPECIFIC HEAT, Cp cal/g°C	DENSITY g/l @ 0°C	CONVERSION FACTOR
Hydrogen Chloride	HCl	0.1912	1.627	1.00
Hydrogen Fluoride	HF	0.3479	0.893	1.00
Isobutylene	C ₄ H ₈	0.3701	2.503	0.29
Krypton	Kr	0.0593	3.739	1.543
Methane	CH ₄	0.5328	0.715	0.72
Methyl Fluoride	CH ₃ F	0.3221	1.518	0.56
Molybdenum Hexafluoride	MoF ₆	0.1373	9.366	0.21
Neon	Ne	0.246	0.900	1.46
Nitric Oxide	NO	0.2328	1.339	0.99
Nitrogen	N ₂	0.2485	1.250	1.00
Nitrogen Dioxide	NO ₂	0.1933	2.052	-. -2
Nitrogen Trifluoride	NF ₃	0.1797	3.168	0.48
Nitrous Oxide	N ₂ O	0.2088	1.964	0.71
Octafluorocyclobutane (Freon - C318)	C ₄ F ₈	0.1866	8.93	0.164
Oxygen	O ₂	0.2193	1.427	0.993
Pentane	C ₅ H ₁₂	0.398	3.219	0.21
Perfluoropropane	C ₃ F ₈	0.194	8.388	0.17
Phosgene	COCl ₂	0.1394	4.418	0.44
Phosphine	PH ₃	0.2374	1.517	0.76
Propane	C ₃ H ₈	0.3885	1.967	0.36
Propylene	C ₃ H ₆	0.3541	1.877	0.41
Silane	SiH ₄	0.3189	1.433	0.60
Silicon Tetrachloride	SiCl ₄	0.1270	7.580	0.28
Silicon Tetrafluoride	SiF ₄	0.1691	4.643	0.35
Sulfur Dioxide	SO ₂	0.1488	2.858	0.69

(Continued on next page)

Gas Correction Factor for Pure Gases (Continued)				
GAS	SYMBOL	SPECIFIC HEAT, Cp cal/g°C	DENSITY g/l @ 0°C	CONVERSION FACTOR
Sulfur Hexafluoride	SF ₆	0.1592	6.516	0.26
Trichlorofluoromethane (Freon - 11)	CCl ₃ F	0.1357	6.129	0.33
Trichlorosilane	SiHCl ₃	0.1380	6.043	0.33
1,1,2-Trichloro - 1,2,2-Trifluoroethane (Freon - 113)	CCl ₂ FCFClF ₂ or (C ₂ Cl ₃ F ₃)	0.161	8.360	0.20
Tungsten Hexafluoride	WF ₆	0.0810	13.28	0.25
Xenon	Xe	0.0378	5.858	1.32

¹Empirically defined²Consult MKS Instruments, Inc. for special applications.

NOTE: Standard Pressure is defined as 760 mmHg (14.7 psia). Standard Temperature is defined as 0°C.

Index

A

AC power range, 17
Accuracy, 67
Alarm outputs, 35
Alarms, 17, 34, 39, 55, 63, 67
Alarms, deactivating, 55

B

Baratron, 22, 41

C

CAL number, 17, 37, 39, 42–43, 44–51, 61
Calibration, 33, 37, 39, 42, 44–51, 44–51
CE compliance, 17, 22, 38, 67
Companion products, 22
Connectors
 I/O, 30, 69
 transducer, 29, 69
Customer support, 19

D

Decimal point position, 33, 37, 39, 40, 42, 44, 61, 63
Dimensions, 26, 69
Dimensions, panel cutout, 25
Display, 69

E

Entries, changing, 40
Environmental, 25
Errors, RS-232, 60

F

Flow units, 50, 52, 73
Front panel, 33
Full Scale calibration, 42
Full scale, setting, 42, 44–51, 44–51
Fuse information label, 38
Fuses, 38, 65, 68
Fuses, replacing, 65

G

Gas Correction Factor, 50

H

Hysteresis, 33, 36, 39, 55, 61, 63

I

I/O connector, 30
Input power, 17, 25, 28, 68, 71
Input wiring, 31
Installation Category, 25
Interface cables, 22
Introduction, 17

L

Local mode, 57

M

Maintenance, 65
Manual, organization, 18
Mass Flow Controllers, 22
MENU key, 33, 39

Model code, 71

Mounting the unit, 27

O

Overrange, 37

P

Panel cutout, 25

Pollution Degree, 25

Power consumption, 38

Pressure output wiring, 31

Pressure units, 37, 42, 44–51, 73

R

Rear panel, 28

Remote mode, 57

Remote zero, 41

Returning the product, 19, 21

RS-232

- baud rate, 59

- cabling, 57

- commands, 61

- communication parameters, 58

- end-of-line delimiter, 58

- errors, 60

- messages, 61

- parity, 59

- protocol, 60

- requests, 63

RS-232 option, 30, 57, 72

S

Safety information, 1–16

Serial lockout, 60

Serial number label, 38

Set points, 33, 34–35, 36, 39, 54, 61, 63

- alarm outputs, 35

- configuring, 54

- hysteresis, 36

Specifications

- electrical, 68

- performance, 67

Symbols, 2

T

Temperature range, operating, 25, 69

Transducer connector, 29

Trip points, 34–35

Z

Zero, 41, 61

Zero, remote, 41